

**BUILT
TO GO
THE DISTANCE.**

marathon[®]
Motors



**COMMERCIAL & INDUSTRIAL
MOTOR SOLUTIONS**

REGAL[®]

marathon[®]
Motors



GET MORE COMMERCIAL & INDUSTRIAL
MOTOR SOLUTIONS FROM TWO
**INDUSTRY-LEADING BRANDS THAT
ARE BUILT TO GO THE DISTANCE.**

PERFORMANCE, POWER AND PRICE. YOU GOT IT.

You don't just need a motor. You need the right frame, mounting, shaft, and output. By combining the best of Marathon[®] brand motors with the finest Century[®] brand motors, you have more ways to find the perfect combination of performance and power.

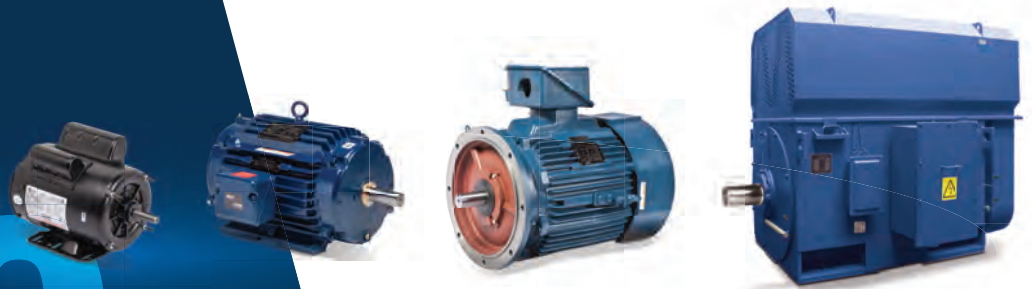

100
YEARS

For more than 100 years, Marathon[®] and Century[®] brand motors have kept the commercial and industrial marketplace in motion, not to mention millions of institutional and residential motor applications that efficiently convert power to motion to keep the world moving. If it moves, or moves you, don't be surprised if our commercial and industrial brands are at the center of it all.

THE BEST TECHNOLOGIES OF
TWO LEADING BRANDS BRING YOU
30% MORE SOLUTIONS.

Whether you specified Marathon brand or Century brand motors in the past, today you have more than 5,000 stock options. Most are in-stock, ready to keep you up and running.

1903

Century company founded

1905

First dual voltage single phase motor

1913

Marathon company founded

1914

Founders design the 1/4 HP washing machine motor

1914

First fractional HP motor makes household refrigeration possible

CONTENTS

OUR ALL NEW CATALOG IS EASY TO USE
AND HELPS YOU SELECT
THE RIGHT MOTOR — FASTER.

Now offering more motor solutions, more motor applications. Finding the right motor is simplified.

HP	VOLTS	FRAME	NO.	Century
1800	115/208-230	56	F101	056C17F5324
1800	115/230	56	C310	056C17F5325
1800	115/208-230	56	F102	5KC46GN0569Y
1800	115/208-230	56	C661	Century
1800	115/230	56	C311	5KC36LN4003Y
3600	115/208-230	56	C664	056C17F5326
1800	115/230	56	F103	Century
1800	115/230	56	C312	143TCFR5328
3600	115/208-230	56	Z123	5KC49TN0063Y
1800	230/115	143T	F10E1	056C17F5327
1800	115/208-230	56	F104	Century
1800	115/230	56	C313	5KC49NN2419Y
1800	115/208-230	56	C663	5KCR48WN0292Y
1800	230/115	56	F15E1	145TBER5328
1800	115/230	145T	Z118	Century
3600	115/208-230	145T	K104	056B17F5307
1800	115/230	145T	F105	5KCR48WN0566Y
3600	115/208-230	145T	F105	5KC49TN0568Y
1800	115/208-230	56H	C659	Century
1800	115/208-230	56H	C660	Century

- GENERAL INFORMATION \ 04 ■
- APPLICATION INFORMATION \ 14 ■
- VARIABLE SPEED INFORMATION \ 20 ■
- SINGLE PHASE \ 24 ■
- GENERAL PURPOSE THREE PHASE \ 39 ■
- SEVERE DUTY \ 73 ■
- EXPLOSION PROOF \ 83 ■
- MEDIUM VOLTAGE \ 89 ■
- INVERTER DUTY "MAX" FAMILY \ 91 ■
- PMAC \ 98 ■
- PMDC \ 100 ■
- IEC \ 104 ■
- BRAKE MOTORS \ 107 ■
- FARM/AGRICULTURE \ 110 ■
- WASH DOWN DUTY® MOTORS \ 121 ■
- PUMP MOTORS \ 136 ■
- HVAC/AIR MOVING \ 170 ■
- OEM REPLACEMENTS \ 207 ■
- DEFINITE PURPOSE \ 215 ■
- MODIFICATIONS \ 226 ■
- KITS & ACCESSORIES \ 237 ■
- INDEX \ 259 ■

30%
MORE
SOLUTIONS

5,000
STOCK
OPTIONS

1915

First totally-enclosed fan-cooled motor

1916

First company to use dynamic rotor balancing

1927

First dual voltage polyphase motors

1928

First rubber mounted cradle base (cushion base)

NEW IN THIS CATALOG

CENTURY® COMMERCIAL AND INDUSTRIAL MOTORS FRAME SIZES FROM 48–449T

SYMAX®-I PMAC 3-PHASE CONDENSER FAN MOTOR (SYMAX™ AND SYMAX-I™ INVERTER)

3-PHASE CONDENSER FAN MOTORS WITH BCP (BEARING CURRENT PROTECTION)

THREE PHASE BRAKE MOTORS LINE EXTENSION

SINGLE PHASE HAZARDOUS DUTY® DIVISION 1 EXPLOSION PROOF MOTORS (GROUP E)

GLOBETROTTER® MOTOR

213-449 Frame:

IP55 and Div II—TEFC
Rolled steel ODP up to 365 frame

TEAO COOLING TOWER, IP56

BLUEMAX® MOTOR, 1 TO 350HP WITH BCP INSTALLED

VERTICAL P-BASE

CRUSHER DUTY

16HP ODP
CROP DRYER

E-TOOLS MATCHED TO THE WAY YOU WORK

Our comprehensive product offering is instantly visible online, not to mention in the palm of your hand. New websites are gearing up to provide lightning-fast product comparisons. Finding and specifying Marathon® and Century® brand motors will never be the same, whether you're behind a desk or in the field.



1940

Current plant is constructed

1956

First fractional HP motor designed for swimming pool pumps

1960

1/20 HP through 3500 HP motors introduced

95% of the motors installed in a major Panama Canal upgrade were Marathon® motors

1976

First Energy Efficient Polyphase Integral HP motors

1981

First two-speed motor, solid state switch with UL approval

1986

Marathon® XRI® product line introduced—leading the industry in NEMA Premium® efficiencies

MODIFICATIONS AT THE WAREHOUSE

ENSURE CUSTOM SOLUTIONS FASTER.

There is no one size motor that fits all applications. That's why we've expanded our modifications offering on most models. Some modifications can be made and shipped same day while others take a day or two, but the line-ready motor solution you need will be ready to work.

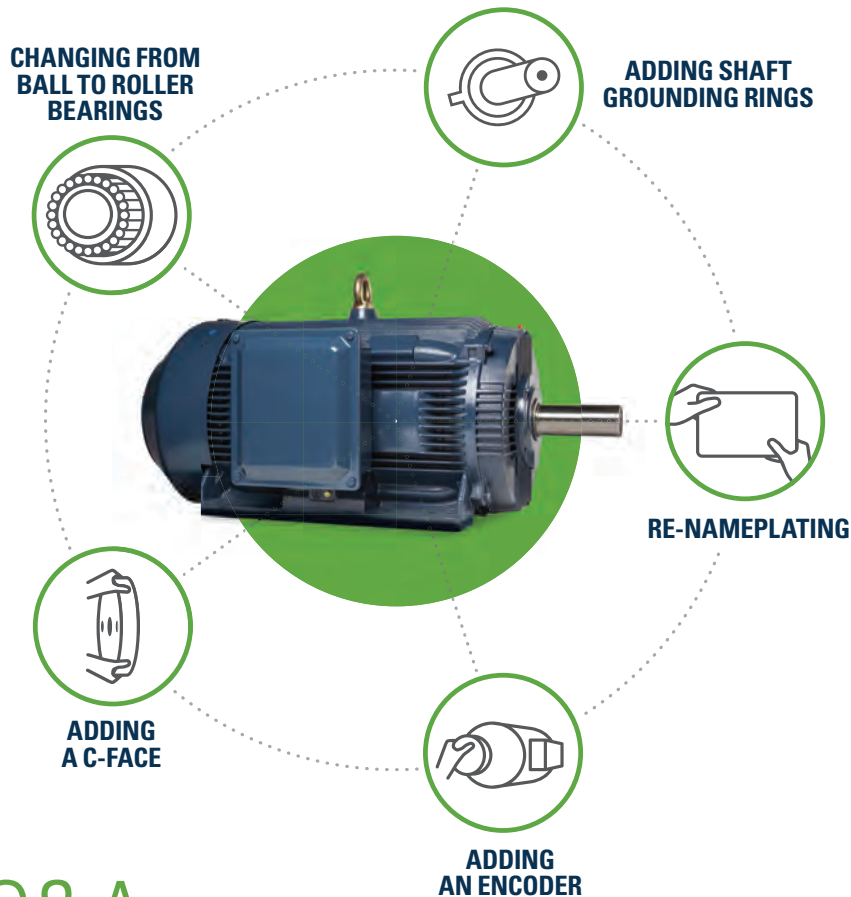

Q&A

YOU'LL HAVE QUESTIONS. WE'LL HAVE ANSWERS.

As you become familiar with specifying and buying commercial and industrial motors from this expanded offering, know that we're ready to assist. We've added more customer service professionals to guide you. Your local field representative is also there for you, so lean on us.

RESIDENTIAL VENTILATION AND LEISURE PUMP MOTORS WILL HAVE THEIR OWN CATALOG.

In the ongoing quest to serve you better and match product to application, residential HVAC/R and pool and spa motors will have their own catalog. You'll still find Commercial & Industrial pump motors in this catalog, but there's no sense in thumbing through hundreds of solutions that—while they deliver brilliantly—aren't geared for your applications. Watch for new residential motor catalogs soon, and more convenient organization online.



THE RIGHT MOTOR.
THE OPTIMAL FIT.
THE PERFECT SOLUTION.

**MORE CHOICES FROM
TWO LEADING BRANDS.**

1997

MAX GUARD® insulation system introduced
Marathon Electric is acquired by Regal

2000

Blue Chip Series® Severe Duty Explosion Proof motor named Plant Engineering magazine product finalist

2004

Regal acquires the commercial AC motor division of General Electric

2010

SyMAX™ permanent magnet AC motor introduced, making Regal a leader in permanent-magnet motor technology

2011

Regal acquisition of the A.O. Smith Electrical Products Company and the Century® brand

2013

Regal celebrates 100 years of the Marathon® brand

TABLE OF CONTENTS

	Page No.
General Information	
Nameplate Information	8
Model number nomenclature	9
Doing business with Regal	10
Operation, Maintenance and Storage	11
Motor Search on REGALBELOIT.COM	12
Service and Warranty	13
Application Information	
Agency Information	14
Mechanical and Electrical considerations	15
Hazardous Duty® overview	16
Terminology	18
Formulas and Conversion factors	19
Variable Speed Information	
Guidelines for general purpose motors on VFD	20
Application considerations	21
NEMA® MOTORS (AC Induction)	
General Purpose Single Phase (NEMA Service Factor)	
Dripproof	
Rigid Base	24
Extended Thru-Bolt, Split Phase, Steel endshield	25
Rigid Base (Century®)	26
Rigid Base (1.0 Service Factor)	27
C-Face Footless	28
C-Face Footed (Rigid Base)	28
Totally Enclosed	
Rigid Base	30
C-Face Footless	32
C-Face Footed (Rigid Base)	34
C-Face Footed (Removable Base) - Four in One	36
Hazardous Duty Division 1 Explosion Proof, Class I and II, Groups C (as noted), D, F, G Motors	
Rigid Base and Resilient Base	37
C-Face Footless and C-Face Footed (Rigid Base)	38
General Purpose Three Phase	
Dripproof - USA Mandated Efficiencies	
Rigid Base, 50 Hz, Standard Efficiency	225
Rigid Base, XRI® Motors	39
Rigid Base, NEMA Premium® Efficiency Motors - Century	44
C-Face Footless, XRI Motors	46
C-Face Footed (Rigid Base), XRI Motors	47
Rigid Base, Globetrotter® Motors	48
Medium Voltage - XRI Motors	89
Totally Enclosed NEMA Premium Efficiency Motors	
Rigid Base, XRI Motors	52
C-Face Footless, XRI Motors	58
C-Face Footed (Rigid and Removable Base) - Four in One, XRI Motors	60
Rigid Base, Globetrotter Motors	63
C-Face Footless Globetrotter Motors	69
C-Face Footed (Rigid Base), Globetrotter Motors	70
Medium Voltage Motors XRI	89
Severe Duty NEMA Premium Efficiency Motors	
Car Wash/ Wet Environment / C-Face Footless, Stainless Shaft IP55, XRI Motors	73
Blue Chip Severe Duty, Cooling Tower, Rigid Base, IP56, BCP, XRI Motors	74
Blue Chip Series® Severe Duty, Rigid Base, XRI Motors	75
Blue Chip Series Severe Duty IEEE-841, Rigid Base, XRI Motors	79
Medium Voltage, XRI	89

	Page No.
Explosion Proof NEMA Premium Efficiency Motors	
Division 1	
Blue Chip Series Hazardous Duty, Division 1 Explosion Proof, Class I and II, Groups D, F & G Motors	83
Hazardous Duty, Division 1 Explosion Proof, Class I and II, Groups C,D,E (as noted) F & G	84
Hazardous Duty, Division 1 Explosion Proof, Class I and II, Groups C,D, F,& G, C-Face Footless	85
Blue Chip Hazardous Duty, Division 1 Explosion Proof, Class I and II, Groups C (as noted),D,F & G	86
Black Max® Vector Duty Explosion Proof, Class I and II, Groups C,D,F, & G, C-Face Footed (Rigid Base)	94
Blue Max® 2000, Explosion Proof, with Encoder, C-Face Footed (Rigid Base), Class I and II, Groups C (as noted),D,F, & G	96
Hazardous Duty®, Division 2/Zone 2	
Totally Enclosed, Class I Motors	
Blue Chip Series, Severe Duty, Rigid Base, XRI Motors	75
Blue Chip Series Severe Duty IEEE-841, Rigid Base	79
Rigid Base, IP55, Globetrotter	63
Medium Voltage	
Inverter (Vector) Duty: "MAX"-series AC Variable Speed motors	
MicroMAX®, Totally Enclosed, C-Face Footless and C-Face Footed (Rigid Base)	91
MicroMAX Plus, (with Encoder), Totally Enclosed, C-Face Footed (Rigid Base)	92
Black Max Vector Duty, Totally Enclosed, C-face Footed (Rigid Base)	93
Black Max, Explosion Proof, Class I and II, Groups C,D,F & G, C-Face Footed (Rigid Base)	94
Blue Max 2000 Vector Duty, Totally Enclosed, Rigid Base and C-Face Footed (Rigid Base)	95
Blue Max 2000, Explosion Proof, with Encoder, C-Face Footed (Rigid Base), Class I and II, Groups C (as noted),D,F & G	96
Blue Max 2000, Brake motor, Totally Enclosed, C-Face Footed (Rigid Base)	97
Blue Max Brakemotor, Totally Enclosed, C-Face Footed (Rigid Base Motors)	90
Permanent Magnet AC	
SyMAXi PMAC Condenser Fan Motors	98
SyMAX® PMAC Motors	99
Permanent Magnet DC	
SCR Rated, Totally Enclosed, C-Face Footed (Removable Base)	100
SCR Rated, Totally Enclosed, C-Face Footless and C-Face Footed (Removable Base) - Century	101
Wash Down, SCR Rated, Totally Enclosed, C-Face Footed (Removable Base)	102
Low Voltage, Totally Enclosed, C-Face Footed (Removable Base)	103
IEC METRIC MOTORS (AC Induction)	
Totally Enclosed	
Globetrotter Motors - B3 mount	104
Globetrotter Motors - B5 and B14 (flange) mount	106
Flange Kits	243
Brakemotors	
Single Phase, Totally Enclosed, C-Face Footed (Removable Base)	107
Three Phase, Totally Enclosed, Rigid Base	108

Shaded items = New Items

TABLE OF CONTENTS

Page No.	Page No.
Brakemotors (continued)	
Three Phase, Totally Enclosed, C-Face Footless	108
Three Phase, Totally Enclosed, C-Face Footed (Removable Base)	109
Blue Max® 2000 Brakemotor, Totally Enclosed, C-Face Footed (Rigid Base)	97
Brake kits: Four-in-One and Black Max.	244
Farm Duty / Agricultural	
Aeration Fan, Single Phase, TEAO, Rigid Base (see HVAC/Air Moving section)	170
Auger Drive, Single Phase or Three Phase, TEFC, N-Flange	112
Center Pivot Irrigation, Three Phase, TEFC, with Drip Cover	118
Cow Cooler Motors	116
Crop Dryer, Single Phase, Dripproof/Air Over, Rigid Base	117
Crop Dryer, Three Phase, Dripproof/Air Over, Rigid Base	118
Extra-High Torque Chore Motor®, Single Phase, TEFC, Rigid Base Motor	111
Extra-High Torque, Farm Rated®, Single Phase, TEFC, Rigid Base or C-Face Footed	111
Fan - PSC, TEAO, Resilient Base-Thru Bolt - Variable Speed	114
Fan - Single Phase Capacitor Start, TEAO, Rigid/Resilient Base - High Efficiency	113
Fan - Single Phase, TEAO, Direct Drive-Thru Bolt	117
Fan - Single Phase, TEAO, Direct Drive-Thru Bolt - Single and Two Speed	114
Fan - Single Phase, TEAO, Resilient Base-Thru Bolt	115
Farm Building Direct Drive	116
Farm Rated Motors	120
Grain Stirring, Single Phase, TEFC, Rigid Base	113
High Torque, Single Phase, TEFC, C-Face Footed (Rigid Base)	110
High Torque, Single Phase, TEFC, Rigid Base	110
Incubator/Hatchery Vent.	118
Instant Reverse Farm Motors	114
Milk Pump Farm Motors	119
Poultry Duty	116
Surge Pump Replacement	120
Zero Milk Tank Farm Motors	119
HVAC motors (Air Moving)	
Aeration Fan (see also Farm/Ag Duty)	170
Attic Fan	171
Centrifugal Fan	171
Circulator Pump, Single Phase, Dripproof - see also Pump/Fluid Handling section.	204
Commercial Condenser Fan/Heat Pump, PSC, Open Air Over, Belly Band, Shaft Up	177
Commercial Condenser Fan/Heat Pump, PSC, Open and Enclosed Air Over, Resilient Ring	176
Commercial Condenser Fan/Heat Pump, PSC, Open Air Over, Rigid Base, Shaft Up or Horizontal	174
Commercial Condenser Fan/Heat Pump, Three Phase, Open Air Over, Shaft Up or Horizontal, BCP	178
Condenser Fan, PSC, Enclosed Air Over, Resilient and Rigid Base Single and Three Phase	173
Condenser Fan, SyMAX-i PMAC Three Phase, Totally Enclosed Air Over	98
Condenser Fan, Three Phase, Air Over, Belly Band/Resilient Ring or Rigid Base, Juggernaut.	180
Condenser Fan/Heat Pump, PSC, Open Air Over, Resilient Ring, Thru-Bolt, All Angle	174
Condenser Fan/Heat Pump, PSC, Open Air Over, Rigid Base, Shaft Up or Horizontal	173
Condenser Fan/Heat Pump, PSC, Open Air Over, Thru-Bolt, Shaft Down	173
Condenser Fan/Heat Pump, PSC, Open Air Over, Thru-Bolt, Shaft Up or Horizontal.	172
Condenser Fan/Heat Pump, PSC, Open Air Over, Thru-Bolt, Shaft Up or Horizontal	175
Condenser Fan/Heat Pump, Three Phase, Open Air Over, Belly Band/Resilient Ring, Shaft Up or Horizontal	179
Evaporative Cooler Motors	181
Exhaust Ventilator, Single Phase, Dripproof, C-Face Footless - Single and Two Speed	199
Fan & Blower - Capacitor Start, Dripproof, Resilient Base - Single and Two Speed	190
Fan & Blower - Direct Drive, PSC, Open Air Over, Belly Band Thru-Bolt, Double Shaft	184
Fan & Blower - Direct Drive, PSC, Open Air Over, Extended Thru-Bolt, 460 Volt	183
Fan & Blower - Direct Drive, PSC, Open Air Over, Resilient Ring	183
Fan & Blower - Direct Drive, PSC, Open Air Over, Resilient Ring, Thru-Bolt mount	182
Fan & Blower - Direct Drive, PSC, Open Air Over, Torsion Flex mount.	183
Fan & Blower - Split Phase and Capacitor Start, Totally Enclosed, Resilient Base - Single and Two Speed	195
Fan & Blower - Split Phase, Dripproof, Rigid Base - Single and Two Speed	189
Fan & Blower - Split Phase, Resilient Base - Single and Two Speed	194
Fan & Blower - Three Phase, Dripproof, Resilient Base - Single and Two Speed	196
Fan & Blower - Three Phase, Dripproof, Resilient Base - Single Speed.	198
Fan & Blower - Three Phase, Totally Enclosed Non Vent, Resilient Base	195
Fan & Blower, Adjustable Ring Mount	198
Furnace Blower - PDQ mount	198
Kiln Duty	220
ME-CAN-DO (Multi-Horsepower), Condenser Fan, PSC, TEAO, Thru-Bolt	205
ME-CAN-DO (Multi-Horsepower), Fan & Blower - Direct Drive, PSC, Open Air Over, Resilient Ring, Thru-Bolt	206
Oil Burner, PSC, 48M flange mount	200
Oil Burner, Single Phase, 48M and 48N flange mount - Century®	202
Oil Burner, Split Phase and Capacitor Start, 48M and 48N flange mount	200
Oil Burner, Split Phase and Capacitor Start, 56C Footless	201
Oil Burner, Three Phase, C-Face Footless (see also Centrifugal Pump, Three Phase)	201
Pedestal Fan, PSC, TEAO, Yoke Mount	213
Refrigeration Fan - Single Phase	203
Refrigeration Fan - Three Phase (see also Condenser Fan/Heat Pump, Three Phase)	203
Transformer Cooling Fan, TEAO, Single Speed, Rigid Base	204
Unit Heater Fan, PSC, TEAO, Resilient Base	204
OEM replacement aftermarket motors 207	
Definite Purpose Motors	
Aggregate Duty	215
Air Compressor	216
Automotive Duty	
T-Frame: GM 7E-TA (Blue Chip Series® Severe Duty IEEE-841, Rigid Base, XRI® Motors	79
T-Frame: Ford EM-1 (Blue Chip Series, Severe Duty, Rigid Base, XRI Motors	75
Carwash Motor	
Severe Duty/Wet Environment, C-Face Footless, Stainless Shaft, IP55	73

TABLE OF CONTENTS

Page No.

Page No.

Definite Purpose Motors (continued)

Cooling Tower

Blue Chip Severe Duty, Cooling Tower, Rigid Base, IP55, XRI 73

Blue Chip Severe Duty, Cooling Tower, Rigid Base, IP56, BCP, XRI 74

Blue Chip Severe Duty, Two-Speed, Totally Enclosed, Three Phase, Rigid Base, IP55 217

Convection and Pizza Oven Motors 222

Instant Reversing

Single Phase Capacitor Start and PSC, Dripproof and Totally Enclosed 219

Dripproof and Totally Enclosed 219

Kiln Duty 220

Multi-Speed

Two-Speed, One-Winding & Two-Winding, Variable Torque, Three Phase, Dripproof, Rigid Base 218

Oil Well Pump 221

Pressure Washer

Single Phase, Dripproof, Rigid Base and C-Face Footed (Rigid Base) 223

Single Phase, Totally Enclosed, Rigid Base and C-Face Footed (Rigid Base) 224

Pump motors (Fluid Handling)

Carbonator Pump, Split Phase, Dripproof 136

Centrifugal Pump (Jet Pump), Single Phase, Dripproof, C-Face Footed (Rigid Base), 56J 139

Centrifugal Pump (Jet Pump), Single Phase, Dripproof, C-Face Footless, 56C/56J 139

Centrifugal Pump (Jet Pump), Single Phase, Totally Enclosed, C-Face Footless, 56C/56J 139

Centrifugal Pump (Jet Pump), Three Phase, Dripproof, C-Face Footed (Rigid Base), 56J 140

Centrifugal Pump (Jet Pump), Three Phase, Dripproof, C-Face Footless, 56C/56J 140

Centrifugal Pump (Jet Pump), Three Phase, Totally Enclosed, C-Face footed (Removable Base), 56J 141

Centrifugal Pump (Jet Pump), Three Phase, Totally Enclosed, C-Face Footless, 56C/56J 141

Centrifugal Pump (Jet Pump), Three Phase, Dripproof or Totally Enclosed, C-Face footless, 56C/56J - Century® 142

Circulator Pump, Single Phase, Dripproof - see also HVAC/Air Moving section 204

Close Coupled Pump, JM, Single Phase, Dripproof, C-Face Footed (Rigid Base) 144

Close Coupled Pump, JM, Single Phase, Totally Enclosed, C-Face Footed (Rigid Base) 144

Close Coupled Pump, JP, Single Phase, Dripproof, C-Face Footed (Rigid Base) 145

Close Couple Pump, JM, Three Phase, Dripproof, C-Face Footed (Rigid Base) or C-Face Footless, NEMA® Premium Efficiency 146

Close Couple Pump, JM, Three Phase, Totally Enclosed, C-Face Footed (Rigid Base) or C-Face Footless, NEMA Premium® Efficiency 150

Close Couple Pump, JP, Three Phase, Dripproof, C-Face Footed (Rigid Base) or C-Face Footless, NEMA Premium Efficiency 154

Close Couple Pump, JP, Three Phase, Totally Enclosed, C-Face Footed (Rigid Base) or C-Face Footless, NEMA Premium Efficiency 158

Fire Pump, Three Phase, Dripproof, Rigid Base 161

Fire Pump, Three Phase, TEFC, Rigid Base 164

Jet Pump (single compartment) - See Centrifugal Pump 139

Jet Pump, Two-Compartment, Single Phase, Dripproof, C-Face Footless, 56C/56J 137

Jet Pump, Two-Compartment, Single Phase, Dripproof, C-Face Footed (Rigid Base), 56C/56J 137

Jet Pump, Two-Compartment, Single Phase, Dripproof, Square Flange 137

Jet Pump, Two-Compartment, Single Phase, Dripproof, C-Face Footless, 56C/56J - Century 138

Jet Pump, Two-Compartment, Single Phase, Dripproof, C-Face Footed (Rigid Base), 56C/56J - Century 138

Jet Pump, Two-Compartment, Single Phase, Dripproof, Square Flange - Century 138

Oil Well Pump 221

Special Direct Replacement Pump Motors - Capacitor Start, Drip Proof, Round or Square Flange 143

Sump Pump, Split Phase, Dripproof 136

Vertical Solid Shaft P-Base, Three Phase, Dripproof 166

Vertical Solid Shaft P-Base, Three Phase, Totally Enclosed 168

Wash Down Duty® - Painted and Stainless Steel

PowerWash™ XT Wash Down Duty®, Single Phase, Rigid Base Motors 121

PowerWash XT Wash Down Duty, Single Phase, C-Face Footless Motors 121

PowerWash Wash Down Duty, Single Phase, C-Face Footed (Rigid Base Motors) 121

PowerWash XT Wash Down Duty, Three Phase, Rigid Base Motors 122

PowerWash XT Wash Down Duty, Three Phase, C-Face Footless Motors 123

PowerWash XT Wash Down Duty, Three Phase, C-Face Footed (Rigid Base Motors) 124

PowerWash XT Wash Down Duty Close Coupled Pump, JM, Rigid Base Motors 125

PowerWash XT Wash Down Duty Centrifugal Pump (Jet Pump), C-Face Footless, 56J Motors 125

PowerWash XT Wash Down Duty Centrifugal Pump (Jet Pump), C-Face Footed, 56J Motors 125

PowerWash XT Wash Down Duty Brakemotor C-Face Footed and Footless Motors 126

PowerWash SXT Wash Down Duty, Single Phase, C-Face Footed (Rigid Base Motors) 127

PowerWash SXT Wash Down Duty, Three Phase, Stainless, C-Face Footless Motors 128

PowerWash SXT Wash Down Duty, Three Phase, Stainless, C-Face Footed (Rigid Base Motors) 129

PowerWash SXT PLUS Wash Down Duty, Single Phase, Stainless/BISSC, C-Face Footless Motors 130

PowerWash SXT Wash Down Duty, Single Phase, Stainless/BISSC, C-Face Footed (Rigid Base Motors) 130

PowerWash SXT PLUS Washdown Duty, Three Phase, Stainless/BISSC, C-Face Footless 131

PowerWash SXT PLUS Wash Down Duty, Three Phase, Stainless/BISSC, C-Face Footed (Rigid Base Motors) 132

PowerWash SXT PLUS Wash Down Duty, Three Phase, Close Couple Pump JM (Rigid Base Motors) 133

PowerWash SXT PLUS Wash Down Duty, Three Phase, C-Face Footed (Rigid Base) Brake Motors 133

PowerWash SXT PLUS Wash Down Duty, Three Phase, C-Face Footed (Rigid Base) IEC Motors 134

PowerWash Extreme Washdown Duty, Three Phase, Stainless/BISSC, C-Face Footless 135

TABLE OF CONTENTS

Wash Down Duty® - Painted and Stainless Steel (Continued)	
PowerWash Extreme Washdown Duty, Three Phase, Stainless/BISSC, C-Face Footed (Rigid Base)	135
Woodworking/Power Tool	225
50 Hertz	225
Modifications through MOD Central	196
Accessory Kits	207
Efficiency - SyMAX® Permanent Magnet Motors	255
Applications - UlteMAX® and NovaMAX® Permanent Magnet Motors	256
“Specials are our Specialty”	257

Index	
Catalog to Model Number	259
Model to Catalog Number	288
Warnings and Cautions	305
NEMA® MG-1 Table 12-11 EPAct Efficiencies	308
NEMA MG-1 Table 12 -12 NEMA Premium® Efficiencies	309
NEMA Quick Reference Dimensional Chart	Fold Out
Footnotes	Fold Out
Blue Chip Series® Product Line Comparison	IBC
IEC Quick Reference Dimensional Chart	Fold Out

HAVE YOU TOURED THE NEW REGAL WEBSITE?

REGALBELOIT.COM

FEATURES:

- In depth information about Regal® brands and products
- Competitive cross-reference tool
- Robust product information details
- Rotating 360° views of products
- View products based on solution and application within a specific industry
- Access to dimensional drawings, CAD files, connection diagrams and more

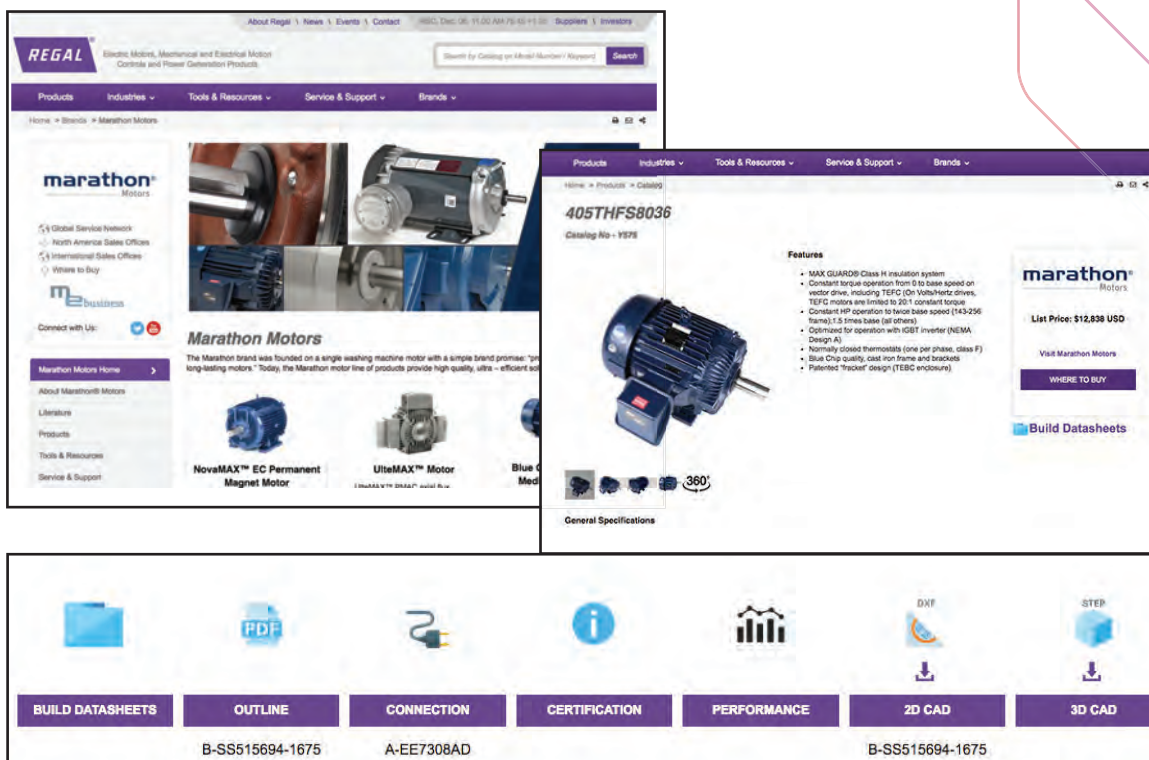

CUSTOMER SEARCH:

Search for products by part number, by product family, by industry, by application, by brand, by solution, by cross reference, by configurator, with engineering tools and more. It is a 360° model designed to guide you to the right item.

INFORMATIONAL TOOL:

The website is packed with information, data, industry facts and statistics.

Regalbeloit.com

NEMA and NEMA Premium are trademarks of National Electrical Manufacturers Association. All Rights Reserved.

marathon®
Motors

GENERAL INFORMATION

MARATHON® MOTORS

Since 1913, the Marathon® name has been recognized for engineering excellence, custom-designed products and an extensive product line of industrial quality motors. Available in all popular enclosures from 1/12 HP through 2500 HP and in a variety of mounting configurations. The unique Marathon motor designs provide more options to add accessories such as; blowers, brakes and encoders, to our motors. Our state-of-the-art lab facilities are equipped and staffed with the finest resources available to ensure successful utilization of our products. Finally, as the preferred supplier of motors to most of the top drive manufacturers in North America, we have what it takes to be a leader in understanding the interaction of drives as they are applied with AC induction motors.

WEBSITE AND E-COMMERCE

Information can be accessed instantly, any time of the day on ME-business. Marathon motor customers can sign-up for ME-business by contacting their sales representative.

ME-business can be accessed through:
www.regalbeloit.com.

- Stock availability
- Order status
- Shipping information
- Invoice information
- Product features and performance data



MARATHON MOTOR NAMEPLATE INFORMATION HOW TO READ THE NAMEPLATE

The nameplate is the key to selecting the proper replacement motor.

Motor Specifications (Example)

Agency Symbols

- CSA Verification Mark - Complies with CSA's Energy Efficiency Verification Service and their Standard C390 - C390 is the Canadian efficiency equivalent of EPAct.
- Underwriters Laboratories, Inc. UL Recognized Component Mark
- UL file # E49747
- CE (Conformité Européene) Marking This mark signifies the motor complies with the European Low Voltage Directive.
- CSA Mark - Certified by the Canadian Standards Association
- CSA file # LR21839
- CC# - Compliance Certification Number as per assigned by the Department of Energy. Motors meeting EPAct efficiencies or higher will have this number.

- MODEL** - The ID number
- DATE CODE** - The month and year manufactured
- MTG.** - Mounting
- FRAME** - The size & mounting
- PART NO.** - Customer part number
- SER.** - Serial number
- TYPE** - Electrical type
- DES.** - Code by NEMA® or IEC
- PH** - Electrical phase usually 1 or 3
- INS CL** - Insulation class
- DUTY** - Time rating under load
- MAX AMB** - The allowable surrounding air temperature
- ENCL** - Enclosure (i.e. TEFC)
- RISE** - The temperature rise over ambient expressed in degrees Celsius when the motor operates at nameplated HP or KW
- IP** - Inherent protection of the enclosure to solids and liquids as defined by IEC 34-5
- IC** - Inherent cooling
- CODE** - NEMA® locked-rotor KVA
- MTH/YR MFG.** - Month and year motor was manufactured
- WT/LBS** - Motor weight in pounds
- WT/KG** - Motor weight in kilograms
- HZ** - Input frequency of the power supply, usually 50 or 60 HZ
- VOLTS** - Voltage rating of the motor at the operating frequency
- HP** - Rated horsepower the motor will produce
- KW** - Rated output in watts
- F.L. AMPS** - The rated load current expressed in amps at nameplated horsepower with nameplate voltage and frequency
- S.F.** - Percentage of the rated horsepower the motor can safely operate at: Example: 1.15 SF (115% of rated HP)
- PF / COS** - Power Factor / Cosine is the ratio of actual power to the apparent power
- RPM** - Full load speed at rated frequency
- NOM EFF** - Average efficiency
- SHAFT END BEARING** - Manufacturer drive end bearing number
- OPP. END BEARING** - Manufacturer opposite drive end bearing number
- SHAFT END BRG** - Drive end bearing size
- OPP** - Opposite drive end bearing size

GENERAL INFORMATION

HOW TO READ A MODEL NUMBER:

Each Marathon® motor carries a model number that can be used to define some of the motor's physical and electrical characteristics.

Example (For Fractional): 1PC48C17D2000AP

This is a breakdown of the model on the nameplate:

1	P	C	48	C	17	D	2000	A	P
1	2	3	4	5	6	7	10	11	12

This is a breakdown of the model in the catalog:

48	C	17	D	2000
4	5	6	7	10

Example (For Integral): 2QA215TBDR A7076ALL

This is a breakdown of the model on the nameplate:

2	Q	A	215T	B	D	R	A	7076	AL	L
1	2	3	4	5	7	8	9	10	11	12

This is a breakdown of the model in the catalog:

215T	B	D	R	A	7076
4	5	7	8	9	10

- DATE CODE** - Year of Manufacture (Not shown in catalog listings.)
- THERMAL PROTECTION** (Not shown in catalog listings.)

	UL Recognized Motor Protector <u>Combination</u>	UL Recognized Motor <u>Construction</u>
Automatic Reset	Automatic Reset	Automatic Reset
Q	Yes	Yes
S	No	No
U	No	Yes
W	#	Yes
Manual Reset	Manual Reset	Manual Reset
P	Yes	Yes
Z	No	Yes
X	No	No
None	None	None
V	No	Yes

Motor protector combination is U.L. recognized only if motor is used in direct drive fan duty application, and is under locked rotor condition, or is running under no-load condition.

- DATE CODE** - Month of Manufacturer (Not shown in catalog listings.)
- NEMA® FRAME SIZE** - (Integral motors - T and U designate standard shaft, TS and US designate short shaft)

5. ELECTRICAL TYPE

Single Phase:

- A = Permanent split capacitor
- B = Capacitor start, capacitor run
- C = Capacitor start, induction run
- N = Split phase start, capacitor run
- S = Split phase

Three Phase:

- T = Three phase
- H = Inverter Duty/IEEE841 Inverter Duty
- V = Medium Voltage

DC Power:

- E = Permanent Magnet DC

6. RPM OR SPEED AT 60 HZ (Fractional Only)

- 34 = 2-Pole, 3600 rpm
- 17 = 4-Pole, 1800 rpm
- 11 = 6-Pole, 1200 rpm
- 8 = 8-Pole, 900 rpm

7. ENCLOSURE

- D = Dripproof
- E = Explosion proof, non-ventilated
- F = Totally enclosed, fan cooled
- G = Explosion proof, fan cooled
- O = Open
- P = Partial
- S = Semi-enclosed
- T = Totally enclosed, non-ventilated
- V = Wash Down, non-ventilated
- W = Wash Down, fan cooled

8. FRAME CONSTRUCTION

<u>Integral</u>	<u>Fractional</u> (where applicable)
L = Aluminum (Full Frame)	B = Rolled Steel - Sourced
Y = Aluminum (Full Frame)	D = Stainless Steel - Sourced
Z = Aluminum (High Mount Down Frame)	U = Frameless - Sourced
H = Aluminum - Sourced	
R = Rolled Steel (Full Frame)	
W = Rolled Steel (Full Frame)	
X = Rolled Steel (High Mount Down Frame)	
B = Rolled Steel - Sourced	
S = Cast Iron (Full Frame)	
N = Cast Iron (Full Frame)	
P = Cast Iron (High Mount Down Frame)	
C = Cast Iron - Sourced	
D = Stainless Steel	

9. STYLE LETTER (A, B, C, etc. indicate redesign)

10. SEQUENCE NUMBER

11. MINOR MODIFICATION LETTER(S)

Fractional - 1 letter; Integral - 2 letters

12. MANUFACTURING CODE - A code for the factory where the motor was manufactured.

GENERAL INFORMATION

HOW TO READ A MODEL NUMBER: Continued

Example ("harmonized" motor design):

A	B	C	D	E	F	G	H	I
5	KH	3	6	K	G	142	-	X

A. Rotating Device

B. Type of Winding

KH - Split Phase
 KC - Capacitor Start, Induction Run
 K - Polyphase
 KCP - Permanent Split Capacitor
 KCR - Capacitor Start, Capacitor Run

C. Lamination Size

3 - 48 frame, 4 - 56 frame

D. Length of Frame

	48 frame	56 frame
2	5.17	5.73
3	5.42	6.63
4	None	None
5	5.80	7.11
6	6.23	None
7	6.63	7.63
8	7.23	8.44
9	Spec.	Spec.

E. Stack Length

A - 5/8"	F - 1-1/4"	L - 1-7/8"	S - 3.0"
B - 3/4"	G - 1-3/8"	M - 2.0"	T - 3-1/4"
C - 7/8"	H - 1-1/2"	N - 2-1/4"	U - 3-1/2"
D - 1.0"	J - 1-5/8"	P - 2-1/2"	W - 4.0"
E - 1-1/8"	K - 1-3/4"	R - 2-3/4"	Q - Spec.

F. Endshield Construction

G & N - Aluminum
 K - Steel
 C - Cap/Can

G. Sequence Number

H. Current Revision (blank if original)

I. Type of Overload

X - UL Auto running & locked rotor
 Y - UL Manual running & locked rotor
 S - UL Auto locked rotor
 T - Non-UL Auto running & locked rotor
 U - Non-UL Manual running & locked rotor
 V - Thermostat
 W - UL motor parts

ORDERING INFORMATION

When ordering, please include the model number, catalog number, description of the motor, quantity, shipping and billing instructions. For pricing of non-stock motors, or if you need assistance in selecting the proper motor, please contact your nearest Regal sales representative or local Marathon® motor distributor. **All prices and data are subject to change without notice.**

CANCELLATIONS AND RETURNS

Stock Product

Stock product can be returned for credit as defined herein. Equipment must be in original packaging, unused in "as shipped" condition and is **limited to products currently maintained in stock inventory**. The quantity returned cannot exceed normal stock quantity level. All motors returned must have date codes no older than 18 months from date of manufacture. The minimum restocking charge is 15% of the original net purchase price. Modified and build to order motors cannot be returned for credit. Return freight charges are the responsibility of the customer returning the motor for credit. **No returns will be accepted without prior authorization.**

NON-STOCK PRODUCT CANCELLATION POLICY:

Cancellation charges for non-stock orders received and entered will be determined based on the percentage of completion in the engineering and manufacturing process, accounting for all costs plus a reasonable profit. Regal's determination of the cancellation charges shall be conclusive.

DISCOUNTS AND MULTIPLIERS

Except as noted, all prices in this catalog are list prices. 200 and 575 volt 3 phase ratings utilize the same list price as 230/460 volt. NEMA® short shaft (TS) utilize the same list price as standard shaft (T). Contact Regal for special bearing systems, including all requirements for sleeve or roller bearing. For your discount and multiplier, contact your local Regal sales representative or local Marathon® motor distributor.

MODIFICATION/ACCESSORIES

See the Modification/Accessories sections for more information on modifications to create special motor variations.

GENERAL INFORMATION

STOCK, NON-STOCK AND BUILD UP MODELS

Standard motors listed in this catalog, as indicated with a check mark (✓) next to the catalog number, are normally in stock. There is no minimum order quantity or minimum billing charge associated with stock motors, unless stated otherwise in your quotation or agreement with Regal.

Production of non-stock catalog models and all build-up models is subject to minimum order quantities or setup charges listed below.

48-140 Frame = 24 piece minimum
 180-250 Frames = 5 piece minimum or \$250 set up/model
 250-320 Frames = 5 piece minimum or \$300 set-up/model

Build-up motors must be thoroughly described at time of order, and/or associated with a formal quotation issued by Regal. **Inclusion of product features for similar motors documented in this catalog should not be assumed.**

SERVICE

For service on any Marathon® motor, contact your nearest Regal authorized service station. For a complete listing of all domestic and foreign service stations, refer to www.regalbeloit.com.

OPERATION AND MAINTENANCE

For information on operation and maintenance, please consult the manual or card shipped with your new motor. Additional copies of "Installation, Operation & Maintenance Instructions" (brochure SB181) are available upon request or through our website, www.regalbeloit.com.

STORAGE PROCEDURES

In the event that long-term storage of motors is required, Regal recommends the following precautions and procedures. This information is also contained in "Installation, Operation and Maintenance Instructions" (SB181).

A. Keep motors clean

1. Store indoors
2. Keep covered to eliminate airborne dust and dirt.
3. Cover openings for ventilation, conduit connections, etc., to prevent entry of rodents, snakes, birds and insects.

B. Keep motors dry

1. Store in a dry area indoors
2. Temperature swings should be minimal to prevent condensation.
3. Space heaters are recommended to prevent condensation.
4. Treat unpainted flanges, shafts and fittings with a rust inhibitor.
5. Check insulation resistance before putting motor into service.

C. Keep bearings lubricated

1. Once per month, rotate shaft several turns to distribute grease in bearings.
2. If unit has been stored more than one year, add grease before start-up (refer to lubrication procedure).

DIMENSION DRAWINGS

See regalbeloit.com or request certified drawings through your Regal sales engineer, representative or local Marathon motor distributor.

GENERAL INFORMATION

HOW TO FIND A MOTOR ON REGALBELOIT.COM

1. From our homepage, enter in the Marathon® Catalog number or Model number in the search box. Hit enter.

2. Then click on Model number in results window. (Note: If you already have a Marathon motor and are looking for the performance data, make sure the model number off the nameplate is what you use for your search. Ex. 056H17T5301).

3. The motor model details page will appear. Scroll down on the motor details results page where there are options to print dimensional drawings and connection diagrams in PDF format for the motors. Under the Technical Data section, click on the link, [Certification Data Sheet](#).

4. The results will look similar to the example shown to the right for the Marathon MaxGuard® motor, model # 405THFS8036. It's that easy!

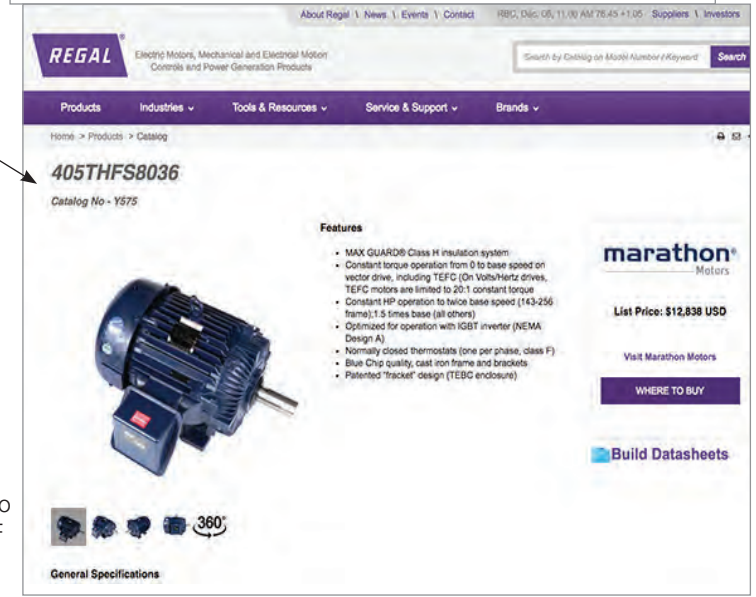
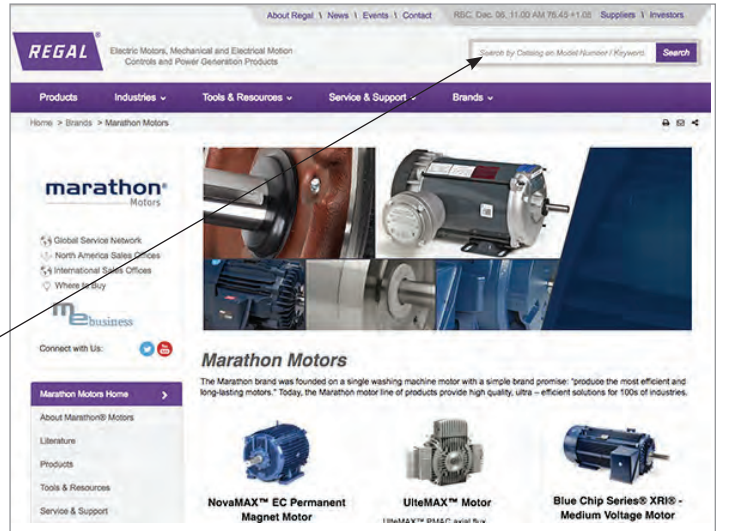

TYPICAL MOTOR PERFORMANCE DATA											
HP	KW	SYNC RPM	FL RPM	FRAME	ENCLOSURE	RYA CODE	DESIGN				
150	75	1800	1725	NET	TEFC	J	80				
PH	NS	VOLTS	FL AMPS	START TYPE	DEFY	INS.	SLP	AMBIC	ELEVATION		
3	480	208VAC	230/115	INVERTER	CONTROL	90	1.0	40	3000		
FULL LOAD EFF. (NEMA)		3% LOAD EFF. (NEMA)	10% LOAD EFF. (NEMA)	50% LOAD EFF. (NEMA)	100% LOAD EFF. (NEMA)	START	STOP	STOP	STOP		
90.0		90.0	90.0	90.0	90.0	90.0	90.0	90.0	90.0		
P.L. TORQUE		LOCKED ROTOR AMPS	L.R. TORQUE	INS. TORQUE	P.L. TORQUE	P.L. TORQUE	P.L. TORQUE	P.L. TORQUE	P.L. TORQUE		
28.0		180.0	180.0	180.0	180.0	180.0	180.0	180.0	180.0		
SOUND PRESSURE	SOUND POWER	MOTOR NOISE	MAX. VIB.	SAFE STALL TIME	STARTS	APPROX. MOTOR					
85 DBA	100 W	110 DBA	0.05 G	1000	1000	1000					
EQUIVALENT WYE DELTA PARAMETERS (OHMS PER PHASE)											
Z11	Z12	Z13	Z21	Z22	Z23	Z31	Z32	Z33			
0.000	0.000	0.000	0.000	0.000	0.000	0.000	0.000	0.000			
Z10	Z20	Z30									
0.000	0.000	0.000									
SUPPLEMENTAL INFORMATION											
FR BRACKET TYPE	COIL BRACKET TYPE	MOULT TYPE	ORIENTATION	REVERSE BOOT	INSULATION LOCATION	DRIP COVER	SCREENS	PAINT			
STANDARD	STANDARD	STANDARD	HORIZONTAL	FALSE	NONE	FALSE	NONE	STANDARD			
REARBASE	DRIBASE	SHAFT TYPE	SPECIAL LE	SPECIAL ODR	SHAFT MATERIAL	FRAME MATERIAL					
NS	NS	FOR YIELD FM	I	NONE	NONE	CAST IRON					
NS	NS										
TEMPERATURE	PROTECTION	INSULATION	INS. RING	INS. RING	TEMPERATURE	CONTROL	SPACE HEATING				
STANDARD	NOV	NONE	NONE	NONE	NONE	FALSE	NONE				

GENERAL INFORMATION

WARRANTY

Regal warrants Fractional and Integral motors to be free from defects in materials and workmanship and to conform to Regal's written specifications. For a copy of our Standard Terms and Conditions of Sale, please visit <http://www.regalbeloit.com>.

MOTOR TYPE	Warranty Period from Date of Installation*	Warranty Period from Date of Manufacture*
Standard warranty for any product not shown below	12	18
Medium voltage	12	18
EPAct compliant (aluminum, steel & cast iron frame)	24	30
Blue Chip Series® motor severe duty explosion proof	24	30
Blue Max® motor, Black Max® motor, & microMax™ motor inverter duty	36	42
All NEMA Premium® incl. ODP, Blue Chip Series motor, severe duty, explosion proof, etc.	36	42
U-Frame automotive duty motor	60	66
Blue Chip Series motor IEEE-841	60	66

* Warranty period shown is in months, and is valid for whichever period expires first.

Note: Brake discs are considered a normal maintenance item and are not covered under warranty.

For more information on Regal's warranty policy, refer to the "Terms and Conditions of Sale." See the footer area on the home page of www.regalbeloit.com.

SUBMITTAL DATA

Mechanical and electrical submittal data is available on many stock catalog motors through our website www.regalbeloit.com by following the three steps listed on the next page. All other submittal data is available upon request when accompanied by a purchase order for the specified motor, **subject to the following additional charges.**

SUBMITTAL CHARGE SCHEDULE

TYPE	ELEMENTS	NET/EA
BASIC (.PDF format)	Nameplate data Motor characteristics Performance data Outline drawing External connection diagram	No-Charge
	Add for .dxf or .dwg format	\$25
BASIC-PLUS (.PDF format)	All "BASIC" elements, tailored to specific order. "Cut sheets" of installed accessories	\$75
	Add for .dxf or .dwg format	\$25
ADDITIONAL ITEMS (.pdf formats)	Speed/Torque curve	\$50
	Torque capability curve	\$50
	Commercial (end of line) test results (not available for West Plains motors)*	\$50
	Certificate of conformance	\$100
	Thermal damage curve (48-326T frame)	\$500 + cost of additional motor
	Thermal damage curve (364T-6805 frame)	\$1500 + cost of additional motor
* Does not imply retesting		

APPLICATION INFORMATION

APPLICATION INFORMATION

AGENCY LISTINGS UL and CSA

Marathon® Fire Pump and Explosion Proof motors are UL listed. Other motor types are UL recognized, including models with inherent overheating protection as noted (i.e. thermally protected models). Marathon motors are also CSA Certified for both explosion proof and non-explosion proof enclosures.

AC MOTORS

Non-Explosion Proof	UL File No. <small>Note 1</small>	CSA File No. <small>Note 2</small>
NEMA® 48-449 Frame	E49747	LR2025
All 5K type models numbers	E46035	MC236833
NEMA 500 and 5000 Frame	—	LR2025*
IEC 63-90 Frame	E49747	LR2025
Thermally Protected motors	E6312	LR2025
Thermally Protected 5K motors	E14133	MC236833
Insulation Systems	E37900	LR2025
Insulation Systems 5K motors	E306343	MC236833

* Does not include coverage for use with VFD

Explosion Proof <small>N. America Division 1 / Zone 1</small>	UL File No. <small>Note 1</small>	CSA File No. <small>Note 2</small>
NEMA 48 Frame	E12044	LR21839
NEMA 56-326 Frame	E12044	LR47504
NEMA 364-449	E12044	LR21839

Fire Pump Motors	UL File No. <small>Note 1</small>	CSA File No. <small>Note 2</small>
NEMA 143-510 Frame ODP	EX5190	LR2025
NEMA 182-5011 Frame TEFC	EX5190	LR2025
IEC 80-355 Frame TEFC	EX5190	LR2025

Class I <small>N. America Division 2 / Zone 2</small>	UL File No. <small>Note 1</small>	CSA File No. <small>Note 2</small>
NEMA 48-449, 5000 Frame, totally enclosed, 3 Phase AC Induction	—	LR21839
NEMA 182-286 Frame, IEC 112-180 Frame, PMAC	—	LR21839
NEMA 213-449 Frame, TEFC, Sourced	E12044	—

European ATEX <small>Zone 2 / Zone 22</small>	Certificate No.
NEMA 143-449 Frame, IEC 112-280 Frame Totally Enclosed, 3 Phase AC Induction	ITS 06 ATEX 45370

European ATEX <small>Zone 2 / Zone 21 / Zone 22</small>	Certificate No.
IEC 80-355 Frame, TEFC, Sourced	DEMKO 17 ATEX 1836X

IECEx <small>Zone 2 / Zone 21 / Zone 22</small>	Certificate No.
IEC 80-355 Frame, TEFC, Sourced	IECEx UL 17.0014X

PMDC MOTORS

Non-Explosion Proof	UL File No. <small>Note 1</small>	CSA File No. <small>Note 2</small>
NEMA Subfractional to145 Frame	E49747	LR2025

Note 1: UL Certifications available online at www.ul.com, select "Online Certifications Directory" link, enter desired UL File No.

Note 2: CSA Certifications available online at www.csagroup.org/services-industries/product-listing/, enter desired CSA File No. using six digit numerical format (e.g. 002025, 021839, etc.)

Conformity Europeenne (CE)

CE marking on the nameplates of Marathon motors is available upon request for most motors rated 600V or less. We do not apply the CE marking to explosion proof motors. The European "Low Voltage" Directive applies to electric motors. Contact a factory representative for details. Non-explosion proof micro-MAX™, BlackMax® and BlueMax® (TENV and TEFC) standard (catalog) models have the CE mark on the nameplate.

ATmospheres EXplosibles (ATEX Directive)

Mandatory by law, the European Union (EU) Directive 94/9/EC requires that electric motors for use in explosive atmospheres carry the CE mark, notified body identifier, Ex symbol, equipment group and category, plus the date code. See "European Installations" for additional details, located on the next page.

National Electrical Manufacturers Association (NEMA®)

Marathon motors are manufactured in accordance with all applicable areas of NEMA standards in MG1-2006. When applied in accordance with the "Guidelines for application of three phase motors on variable frequency drives", **Marathon motors are in full compliance with NEMA MG1-2006, Part 31, Section 4.4.2**, as pertaining to voltage spikes. 460 volt motors must withstand voltage spikes of up to 1426 volts; 575 volt motors must withstand spikes up to 1788 volts. See "Insulation Systems" for additional detail on this subject.

COMMITMENT TO ROHS AND WEEE EUROPEAN DIRECTIVES

European Directive 2002/95/EC "Restriction of Use of Certain Hazardous Substances" (RoHS) and Directive 2002/96/EC "Directives on Waste Electrical and Electronic Equipment" (WEEE) were enacted to control the amount of certain hazardous substances contained in products shipped into the E.U. Restricted substances include lead, mercury, cadmium, hexavalent chromium, polybrominated biphenyls and polybrominated dipheynl ethers.

The scope of products covered, affecting motors, is:

- Large household appliances
- Small household appliances
- IT and telecommunications equipment
- Consumer equipment
- Electrical and electronic tools (except large scale stationary and industrial tools)
- Toys, leisure and sports equipment
- Automatic dispensers

The Directives do not currently apply to medical devices, monitoring and control instruments, spare parts for the repair or reuse of electrical and electronic equipment placed on the market before July 1, 2006 and most military and state security equipment.

Regal worked closely with suppliers to assure that product falling within the scope of these Directives meets the specified levels of these substances. The Directives took affect July 1st, 2006; however, many products were converted in May and June. The products converted are motors in NEMA frame size 145 and below, both AC and DC motors with the following exceptions:

- Sleeve bearing motors
- Brake motors in 56-145 frame will have to be ordered specifically as RoHS compliant.
- Some motors with specialty electro-mechanical components.

Continued on next page.

APPLICATION INFORMATION

BEARINGS

FRAME SIZE	STANDARD TYPE	COMMENTS
48	Shield Ball	
56 - 184T	Sealed Ball	
182 - 444T	Double Shield Ball	
284 - 449TS	Single Shield Ball	
445T - 6805	Double Shield Ball	Direct - coupled loads
445T - 6805	Roller (DE)/Ball	Belted loads

* **Belting data must be provided on all belted applications.**

Standard horizontal motors can be mounted in a vertical shaft down orientation (except brakemotors). Contact a factory representative for shaft up mounting arrangements.

Motors for use in vertical shaft up or shaft down configurations must be reviewed by engineering before ordering.

Marathon® motors employ the use of Mobil POLYREX® EM grease, a specially formulated bearing grease designed for electric motors. POLYREX EM provides superior lubricity, durability and resists corrosion, rust and washout. POLYREX EM is a registered trademark of Mobil Corporation.

Maximum safe mechanical speed capability is a function of bearing size, type and grease selection, as well as rotor balance specifications. Consult the "Maximum Safe Mechanical Speed Limits" chart in the "Overspeed Capability" section.

Note that these values do not imply maximum constant horsepower RPM.

EFFICIENCY

The efficiency of a motor is the ratio of its useful power output to its total power input and is usually expressed in a percentage. Marathon motors are available with standard, high efficient EPA^{act}, and **NEMA Premium®** efficient ratings. Standard efficiency motors may only be used on applications that are exempt from legislated efficiencies. The high efficient motor line is in compliance with the Energy Policy Act of 1992 (EPA^{act}) and/or Canadian efficiencies as set by NRCAN. The Energy Independence and Security Act of 2007 (**EISA07**) law on December 19, 2010, requiring current EPA^{act}-compliant motors to meet NEMA Premium efficiencies, and most EPA^{act}-exempt motors to meet EPA^{act} levels. XRI Premium efficient motors in this catalog meet NEMA Premium unless otherwise noted.

The XRI® motor line is a premium efficiency line, which exceeds mandated efficiencies of EPA^{act} and /or NRCAN. Unless otherwise noted, XRI premium efficient motors in this catalog meet NEMA Premium the newly promoted efficiency levels by NEMA and the Consortium for Energy Efficiency (CEE).

ELECTRICAL TYPE/STARTING METHOD

Motors in this catalog are capacitor start, split phase, permanent split capacitor, or three phase. Capacitor start motors have high starting torque, high breakdown torque, and relatively low starting current. Split phase motors have medium starting torque and medium starting current. Permanent split capacitor motors have low starting torque and low starting current. Three phase motors have high starting, extra breakdown torque, and typically very low starting current. Single phase motors cannot be applied on variable frequency drives with three phase output.

ENCLOSURE AND METHOD OF COOLING

Marathon motors are available in various enclosures; Drip-proof (DP), Drip-proof Force Ventilated (DPFV), Totally Enclosed Fan Cooled (TEFC), Totally Enclosed Non-Ventilated (TENV), Totally Enclosed (TEAO) and Totally Enclosed Blower Cooled (TEBC). Application conditions will determine the type of motor enclosure required.

Drip-proof motors have open enclosures and are suitable for indoor use and in relatively clean atmospheres. Drip-proof motors have ventilating openings constructed so that drops of liquid or solid particles falling on the machine at an angle of not greater than 15 degrees from the vertical cannot enter the machine.

Totally enclosed motors are suitable for use in humid environments or dusty, contaminated atmospheres. Totally enclosed non-ventilated motors are NOT cooled by external means. Totally enclosed fan cooled motors are cooled by external means that are part of the motor but not in the internal workings of the motor. Totally enclosed air over motors are sufficiently cooled by external means, provided by the customer.

HAZARDOUS DUTY® MOTORS

Hazardous Duty motors are totally enclosed (fan cooled or non-ventilated) motors designed for applications in hazardous atmospheres containing explosive gases and/or combustible dusts.

NORTH AMERICAN INSTALLATIONS

North American standards for electric motors generally fall into one of two divisions. Division 1 Explosion Proof motors are UL listed in accordance with NFPA Class I (Flammable Gases) or Class II (Combustible Dusts) and Groups (gases or dusts), depending upon the atmosphere. Division 2 motors are CSA certified and are marked similarly to Division 1 equipment. Inverter duty motors through 449T frames are CSA certified for use in Division 2 locations.

EUROPEAN INSTALLATIONS

Motors for hazardous locations in Europe must meet a different set of standards and require different markings than those of North America. CENELEC sets the standards for equipment in hazardous locations for Europe. Motors for use in explosive atmospheres in Europe are often referred to as flameproof (Zone 1) or non-sparking (Zone 2) motors. These motors must comply with the ATEX Directive. The ATEX Directive covers all electrical equipment used in explosive atmospheres. To ensure compliance with the Directive, equipment must meet the essential ATEX requirements and carry the CE mark on the nameplate. Other information required on the nameplate includes the Ex symbol, group & category, Ex protection method, gas group, and temperature code, example (Ex) II 3 G Ex nA IIC T3.

The tables on the next page describe Marathon motor capabilities by area classification and by temperature code.

Polyrex is believed to be the trademark or trade name of Exxon Mobil Corporation and is not owned or controlled by Regal Beloit Corporation.

NEMA and NEMA Premium are trademarks of National Electrical Manufacturers Association. All Rights Reserved.

APPLICATION INFORMATION

IEC DEGREES OF PROTECTION vs. MARATHON STANDARD MOTOR CONSTRUCTION

The enclosure terminology for an IEC motor is a combination of the IP (Ingress Protection) and IC (Inherent Cooling) codes. Each number in the IP code stands for a different degree of protection.

- IP12 - Dripproof
- IP22 - Dripproof with screens, or die cast aluminum bracket
- IP43 - Totally enclosed
- IP54 - Totally enclosed severe duty
- IP55 - Totally enclosed severe duty with v-ring shaft seals, and/or "Smart Ring" rotating shaft seal and neoprene gaskets
- IP56 - Totally enclosed severe duty with rotating shaft seals (eg. Inpro/Seal® VBX® bearing isolator) and neoprene gaskets

MARATHON® HAZARDOUS DUTY MOTOR AREA CLASSIFICATION CHART

CLASS II AREA CLASSIFICATION (Flammable Gases, Vapors or Mists)				CLASS II AREA CLASSIFICATION (Combustible Dusts)			
NORTH AMERICA		EUROPE - ATEX (Category G - Gases)		NORTH AMERICA		EUROPE - ATEX (Category D - Dusts)	
Division 1 Explosion Proof	Division 2 TEFC & TENV	Zone 1 Flameproof	Zone 2 Non-Sparking	Division 1 Explosion Proof	Division 2	Zone 21 Flameproof	Zone 22 Non-Sparking
Group A ①	Group A	Contact your sales representative for ATEX Zone 1 capabilities	Group II C, Category G	-	-	-	-
Group B ②	Group B		Group II C, Category G	-	-	-	-
Group C	Group C		Group II B, Category G	-	-	-	-
Group D	Group D		Group II A, Category G	-	-	-	-
-	-	-	-	Group E	-	Category D	Category D
-	-	-	-	Group F ①	Group F	Category D	Category D
-	-	-	-	Group G ①	Group F	Category D	Category D

- Group is not applicable to that Division or Zone, or is not defined.
- ① Group is not available as a Marathon motor.
- ② Contact factory representative for availability.

MARATHON HAZARDOUS DUTY MOTOR TEMPERATURE CODE CHART

Temp.	TEMPERATURE CODES		DIVISION 1 EXPLOSION PROOF/ZONE 1 FLAMEPROOF		DIVISION 2/ZONE 2 NON-SPARKING
	UL/CSA	ATEX	CLASS I AREA CLASSIFICATION (Flammable Gases, Vapors or Mists)	CLASS II AREA CLASSIFICATION* (Combustible Dusts)	CLASS I AREA CLASSIFICATION (Flammable Gases, Vapors or Mists)
			Division 1/ Zone 1	Division 1/ Zone 21	Division 2/ Zone 2
280°C	T2A	T2(280)	Explosion Proof - Class I, Group D (Group C as noted)		
260°C	T2B	T2(260)			XRI® Severe Duty & IEEE-841 @ 1.15 S.F., Class I, Groups A,B,C,D (Sine wave power)
215°C	T2D	T2(215)			Available through Mod Central on Totally Enclosed EPAct, XRI®, XRI® Severe Duty motor or IEEE-841 @ 1.0 S.F. on PWM VFD, Class I, Groups A,B,C,D
200°C	T3	T3			Available through Mod Central on Totally Enclosed EPAct, XRI®, XRI® Severe Duty motor or IEEE-841 @ 1.0 S.F., Sine wave power Class I, Groups A,B,C,D
165°C	T3B	T3(165)	Explosion Proof - Class I, Group D (Group C as noted) Sine wave or PWM power	Explosion Proof - Class II, Groups F & G, Sine wave or PWM power	
160°C	T3C	T3(160)	Available through Mod Central on Explosion Proof - Class I, Group C & D @ 1.0 S.F. - Contact factory	Available through Mod Central on Explosion Proof - Class II, Group F & G @ 1.0 S.F. - Contact factory	
135°C	T4	T4	ATEX compliant motors	ATEX compliant motors	

Division I & II ambient range is -25°C to +40°C.

ATEX ambient range is -20°C to +40°C.

Consult your sales representative for higher ambients.

APPLICATION INFORMATION

APPLICATION INFORMATION

INSULATION SYSTEMS

Class B – General Purpose motors that employ Class B insulation systems have a total temperature rating of 130°C and maximum allowable temperature rise of 80°C at 1.0 S.F.

Class F – Motors with a Class F system have a total temperature rating of 155°C, with a maximum temperature rise of 105°C at 1.0 S.F. Many Marathon® motor designs utilize a Class F system but limit temperature rise to no higher than “B” rise, providing thermal “headroom” for longer insulation life.

Class H – Class H insulated motors have a total temperature rating of 180°C and maximum allowable temperature rise of 125°C. All Marathon motors that employ a Class H system are designed to operate between “B” and “F” rise, giving the user a generous thermal cushion.

“CR²⁰⁰” – Corona Resistant, 200° rated magnet wire is utilized in numerous general purpose and inverter duty motor designs to extend insulation life under the rigors of steep fronted voltage spikes, common with today’s IGBT inverters. Refer to page 17 for product lines that employ the use of CR²⁰⁰ magnet wire.

Motors with the CR²⁰⁰ insulation system can be operated at up to 475 feet from the drive on 460 volt systems, at 3 KHz carrier frequency. For other voltages and/or carrier frequency combinations, contact a factory representative.

MAX GUARD® MOTORS – All Black Max®, Blue Max®, Blue Chip Series®, XRI® Severe Duty and XRI®-841 (IEEE841) motors feature the MAX GUARD® insulation system, either in conjunction with Class F or Class H materials. Combining corona-resistant magnet wire (CR²⁰⁰) with our patented “low stress” winding configuration and uncompromising quality standards, MAX GUARD® motors deliver long, dependable motor life under the adverse thermal and dielectric stresses imposed by IGBT-based variable frequency drives. **MAX GUARD motors surpass the requirements of NEMA® MG1-2006, Part 31, Section 4.4.2.**

460 Volt (or lower) motors equipped with MAX GUARD® insulation can be operated at any distance from the drive and at any carrier frequency. 575 Volt motors can be operated at up to 650 feet cable length at 3 KHz.

MOUNTING

Most Marathon motors are designed for horizontal mounting (shaft parallel with ground), unless designed otherwise, such as Vertical P base motors. As a general rule, a horizontal motor can also be mounted in a vertical shaft down orientation. Horizontal motors should never be mounted in a vertical shaft up orientation without consulting your application engineer, as this practice can cause damage to the motor, which is not covered under warranty. Brakemotors should not be mounted vertically (up or down), unless the brake has been specifically designed for such.

NEMA® SERVICE FACTOR RATINGS

The table below lists the NEMA service factors for single phase, dripproof motors. Totally enclosed and explosion proof motors have 1.0 service factor except where noted.

Single Phase

NEMA SERVICE FACTOR @ RPM LISTED

HP	3600	1800	1200	900
1/12	1.4	1.4	1.4	1.4
1/8	1.4	1.4	1.4	1.4
1/6	1.35	1.35	1.35	1.35
1/4	1.35	1.35	1.35	1.35
1/3	1.35	1.35	1.35	1.35
1/2	1.25	1.25	1.25	1.15
3/4	1.25	1.25	1.15	1.15
1	1.25	1.15	1.15	1.15
1.5 & up	1.15	1.15	1.15	1.15

OVERLOAD PROTECTION

There are four choices in protection: manual (inherent type), automatic (inherent type), thermostats, and none. A manual overload must be physically reset to restart the motor. An automatic thermal overload will stop the motor when it is overloaded or overheated and restart it after the motor has cooled down. None means the motor has no protection. Thermostats are embedded in the winding and connected to the motor starter control circuit. Marathon motors are normally provided with one closed thermostat per phase.

⚠ CAUTION

- A motor with an automatic reset protector must not be used where automatic restarting (after motor cool-down) would endanger personnel or equipment. Such application should use a manual reset protector.

PHASE/POWER SUPPLY

Is the power supply three phase or single phase? Most home and farm applications require single phase motors, while most factories, large commercial and industrial users require three phase motors. Single phase motors can be used on three phase systems. Three phase motors, however, cannot be operated from single phase systems. Motor damage will result.

ROTATION

Most motors in this catalog are reversible by electrical reconnection or by physical orientation. The standard rotation from the factory for a single phase Marathon motor is counterclockwise, when viewing the opposite shaft end of the motor.

SPEED/RPM

3600, 1800, and 1200 are the most common 60 HZ synchronous speeds with full load speed equivalents of 3450, 1725, and 1150.

APPLICATION INFORMATION

TERMINOLOGY

Ambient Temperature – Temperature of the medium, such as air, water or earth, into which the heat of the equipment is dissipated.

Across The Line Start - A method of motor starting that applies full line voltage to the motor. The motor is connected directly to the power source.

Base Speed – Nameplate rating where the motor will develop rated HP at rated load and voltage. With AC systems, it is commonly the point where 60 Hz is applied to the induction motor.

Breakaway Torque – The torque required to start a machine from standstill.

Breakdown Torque (BDT) – The maximum torque that an AC motor will develop with rated voltage applied at rated frequency while rotating.

Cogging – A condition in which a motor does not rotate smoothly but “steps” or “jerks” from one position to another during shaft revolution. Cogging is most pronounced at low motor speeds and can cause objectionable vibrations in the driven machine.

Continuous Duty – The continuous rating is the maximum constant load that can be carried continuously without exceeding established temperature rise limitations under prescribed conditions of load and within the limitations of established standards.

Definite Purpose Motor – Any motor design, listed and offered in standard ratings with standard operating characteristics and mechanical construction, for use under service conditions other than usual or for use on a particular type of application (NEMA®).

Duty Cycle – The relationship between the operating and resting times or repeatable operation at different loads and/or speeds.

Efficiency – Ratio of power output to power input indicated as a percentage. In motors, it is the effectiveness with which a motor converts electrical power into mechanical power.

Frequency – Number of cycles per second of alternating current 60HZ used primarily in North America, 50HZ normally used overseas.

Full Load Torque (FLT) – The torque necessary to produce rated horsepower at full load speed.

General Purpose Motor – This motor has a continuous duty rating and NEMA A or B design, listed and offered in standard ratings with standard operating characteristics and mechanical construction for use under usual service conditions without restriction to a particular application or type of application (NEMA).

Inertia – A measure of a body’s resistance to changes in velocity, whether the body is at rest or moving at a constant velocity. The velocity can be either linear or rotational. The moment of inertia (WK^2) is the product of the weight (W) of an object and the square of the radius of gyration (K^2). The radius of gyration is a measure of how the mass of the object is distributed about the axis of rotation. WK^2 is usually expressed in units of lb-ft².

Inrush Current – The initial surge of current into the windings. Inrush current can be up to ten times higher than the continuously needed current because there is low initial resistance.

Intermittent Duty – A motor that never reaches equilibrium temperature, but is permitted to cool down (to ambient temperature) between operations. For example, a crane, hoist or machine tool motor is often rated for 15, 30 or 60 minute duty.

Load Sharing – An application condition in which two or more similar-sized AC Induction motors are mechanically connected to each other and powered from the same inverter. Optimum load sharing is achieved with higher slip (NEMA Design B or C) motors.

Locked Rotor Current (LRA) – Steady state current taken from the line with the rotor at standstill, at rated voltage and frequency. This is the current when starting the motor and load across the line.

Locked Rotor Torque (LRT) – The minimum torque that a motor will develop at rest for all angular positions of the rotor, with rated voltage applied at rated frequency.

No Load (Conditions) – The state of a machine rotating at normal speed under rated conditions, but when no output is required from it.

Part Winding Start (PWS) – A method of reduced voltage starting that applies power to only one set of windings, then to the other set as the motor comes up to speed.

Power Factor – Power factor is the ratio of real power (kW) to total kVA, or the ratio of actual power (W) to apparent power (volt-amperes).

Reactance – The opposition to the flow of current made by an induction coil or a capacitor. Performance data expresses stator reactance as X1 and rotor reactance as X2.

Resistance – The opposition to voltage or current in an electrical circuit. Performance data expresses stator resistance as R1 and rotor resistance as R2.

Rotor – The rotating member of a machine with a shaft.

Service Factor (SF) – When used on a motor nameplate, a number which indicates how much above the nameplate rating a motor can be loaded intermittently without causing serious degradation (i.e. a motor with 1.15 SF can produce 15% greater torque than one with 1.0 SF, within temperature constraints).

Squirrel Cage Induction Motor – When used on a motor nameplate, a number which indicates how much above the nameplate rating a motor can be loaded without causing serious degradation (i.e. a motor with 1.15 SF can produce 15% greater torque than one with 1.0 SF, within temperature constraints).

APPLICATION INFORMATION

TERMINOLOGY

Shock Load – The load seen by a clutch, brake or motor in a system that transmits high peak loads. This type of load is present in crushers, separators, grinders, conveyors, winches and cranes.

Slip – The difference between the speed of the rotating magnetic field (synchronous speed) and mechanical rotational speed (rotor speed) of AC induction motors. Usually expressed as a percentage of synchronous speed.

Special Purpose Motor – A motor with special operating characteristics, special mechanical construction, or both, designed for a particular application and not falling within the definition of a general purpose or definite purpose motor (NEMA®).

Speed Range – The minimum and maximum speeds at which a motor must operate under constant or variable torque load conditions. A 50:1 speed range for a motor with top speed of 1800 RPM means the motor must operate as low as 36 RPM and still operate within specifications.

Starting Torque – The torque exerted by the motor during the starting period.

Stator – The stationary portion of the magnetic circuit and the associated windings and leads of a rotating machine.

Synchronous Speed – The speed of an AC induction motor's rotating magnetic field. It is determined by the frequency applied to the stator and the number of magnetic poles present in each phase of the stator windings. Mathematically, it is expressed as Sync Speed (RPM) = $120 \times \text{Applied Frequency (Hz)} / \text{Number of Poles per phase}$.

Torque – A turning force applied to a shaft, tending to cause rotation. Torque is normally measured in "pound-feet" and is equal to the force applied times the radius through which it acts.

Torque-to-Inertia Ratio – The rated motor torque divided by its rotor inertia. Helps determine a motor's ability to accelerate loads and/or respond to commands from a drive to change speed or direction.

Voltage Drop – The reduction in voltage level from the source to the load caused by conductor resistance.

Wye Start Delta Run (YD) – A method of reduced voltage starting that first connects a motor in a wye to reduce voltage, then reconnects the motor in a delta to provide full line voltage.

FORMULAS & CONVERSION FACTORS

Horsepower (HP) = Torque (lb-ft) x RPM / 5252

Horsepower (HP) = Torque (lb-in) x RPM / 63025

Torque (lb-ft) = HP x 5252 / RPM

Torque (lb-in) = HP x 63025 / RPM

Efficiency = Power Out / Power In

Synchronous RPM = $120 \times \text{Frequency} / \# \text{ Poles}$

Ohms = Volts / Amperes ($R = E/I$)

Amperes = Volts / Ohms ($I = E/R$)

Volts = Amperes x Ohms ($E = IR$)

Static Torque (T) = F x R (lb-ft),

F = Force (lb),

R = pulley or drum radius (ft)

Pound-feet (torque) = $.7376 \times \text{Newton-meters}$

Newton-meters (torque) = $1.3558 \times \text{lb-ft}$

Power (HP) = Torque (lb-ft) x $2\pi \times \text{RPM} / 33000$

Temperature (Celsius) = $5/9 \times (F^\circ - 32)$

Temperature (Fahrenheit) = $(9/5 \times C^\circ) + 32$

1 Kilowatt (KW) = 1.341 Horsepower

1 Horsepower = 746 watts (.746 KW)

Brake Torque = $(5252 \times P / N) \times SF$, P = HP, N = RPM, SF = 1.4

Use 2.0 to 2.5 SF for cranes and hoists (consult crane manufacturer or user).

VARIABLE SPEED OPERATION

Guidelines for application of general purpose, three phase, single speed motors on variable frequency drives meets NEMA® MG1-2006 part 30 and part 31 section 4.4.2. Unless stated otherwise, motor nameplates do NOT include listed speed range.

ENCLOSURE	EFFICIENCY	VARIABLE TORQUE	CONSTANT TORQUE								
		ALL FRAMES	56	143-215		254-286		324-365		404-449	
NEMA Motors		ALL POLES	ALL POLES	2-Pole	4&6 Pole	2-Pole	4&6 Pole	2-Pole	4&6 Pole	2-Pole	4&6 Pole
ODP	Standard (EPAAct exempt)	10:1	2:1	2:1	2:1	Contact Engineering					
	EPAAct compliant	10:1	N/A	2:1	2:1	2:1	2:1	Contact Engineering			
	NEMA Premium	10:1	N/A	10:1	10:1	10:1	10:1	10:1	10:1	2:1	2:1
TEFC	Standard (EPAAct exempt)	10:1	2:1	2:1	2:1	Contact Engineering					
	EPAAct compliant	10:1	N/A	2:1	10:1	2:1	10:1	2:1	2:1	2:1	2:1
	NEMA Premium	10:1	N/A	2:1	20:1	2:1	20:1	2:1	20:1 (1)	2:1	20:1 (1)
TENV	EPAAct compliant	10:1	N/A	1000:1	1000:1	1000:1	1000:1	1000:1	1000:1	1000:1	1000:1
	NEMA Premium	10:1	1000:1	1000:1	1000:1	1000:1	1000:1	1000:1	1000:1	1000:1	1000:1
Washdown TEFC	Standard (EPAAct exempt)	10:1	10:1 (2)	10:1 (2)	10:1 (2)	N/A	N/A	N/A	N/A	N/A	N/A
	EPAAct compliant	10:1	10:1 (2)	10:1 (2)	10:1 (2)	N/A	N/A	N/A	N/A	N/A	N/A
	NEMA Premium	10:1	10:1 (2)	10:1 (2)	10:1 (2)	N/A	N/A	N/A	N/A	N/A	N/A
Washdown TENV	Standard (EPAAct exempt)	10:1	1000:1	1000:1	1000:1	N/A	N/A	N/A	N/A	N/A	N/A
	EPAAct compliant	10:1	1000:1	1000:1	1000:1	N/A	N/A	N/A	N/A	N/A	N/A
	NEMA Premium	10:1	1000:1	1000:1	1000:1	N/A	N/A	N/A	N/A	N/A	N/A
Explosion Proof	All efficiency levels	Explosion Proof motors must be properly nameplated with inverter duty information prior to use on VFD. See Marathon motor catalog pages for specific rating capabilities. Motors with automatic overload protectors cannot be used on VFDs.									
IEC Motors		ALL FRAMES	63-90		100-225		250-315				
All enclosures	All efficiency levels	10:1	20:1		Up to 20:1		Up to 2:1				

- Notes:** (1) 324-449T, 4 & 6 Pole XRI® motors are rated for 20:1 C.T. with fan modification; otherwise rated for 2:1 C.T. continuous duty, or 20:1 C.T. 60 minute duty at lowest RPM.
 (2) Washdown TEFC motors are rated for 10:1 C.T. 60 minute duty or 2:1 C.T. continuous duty at lowest RPM.
 (3) Model numbers beginning with 5K are not suitable for use with variable frequency drives.

APPLICATION NOTES

Bearing currents Regal recommends that all motors used with variable frequency drives be equipped with suitable means to protect the motor bearings from shaft currents caused by common mode voltages inherent with operation on a non-sinusoidal power supply. Regal offers several options for motors in non-classified (non-hazardous) locations, including ground brushes, insulated bearings and non-contact shaft grounding rings. For more information on ground brushes and bearing currents, see the VARIABLE SPEED OPERATION section. For installation cost and available options, see the MOD CENTRAL section.

Restricted use DO NOT APPLY THE FOLLOWING MOTORS ON VARIABLE FREQUENCY DRIVES: Single phase motors, motors with inherent overload protection, Multi-speed motors, motors with 1.0 service factor on sine wave power. Fire pump motors should not be used with variable frequency power supplies, due to the critical nature of these applications.

Hazardous Locations Consult with your sales representative or contractor when applying motors and drives into hazardous locations, either division/zone 1 or division/zone 2 areas. UL and CSA policies prohibit the installation of bearing protection devices, such as shaft grounding brushes, rings or insulated bearings on motors in hazardous locations.

MAXIMUM CABLE LENGTHS FROM THE MOTOR TO DRIVE

PRODUCT DESCRIPTION	3 kHz CARRIER FREQUENCY (PHASE TO PHASE)*		
	230 VOLT	460 VOLT	575 VOLT
56-326 NEMA, 100-225 IEC frames	600 ft.	125 ft.	40 ft.
364-5013 NEMA, 250-315 IEC frames	1000 ft.	225 ft.	60 ft.
Motors with CR ²⁰⁰ corona resistant magnet wire	1500 ft.	475 ft.	140 ft.
Motors with MAX GUARD® insulation system	Unlimited	Unlimited	650 ft.
Form-wound low voltage motors	Unlimited	Unlimited	650 ft.

STANDARD MOTOR INSULATION SYSTEMS

CR200 CORONA-RESISTANT MAGNET WIRE	Max Guard® Insulation System*
microMAX™ inverter duty	Black Max® Vector duty motor - All product
4-in-1® three phase, C-face with removable base	Blue Max® Vector duty motor - All products
Standard three phase stock brakemotors	PowerWash™ XT, SXT, and SXT-Plus Wash Down Duty® motor - three phase
Blue Chip Series® severe duty explosion proof, EPAAct efficiency	Blue Chip Series® XRI® severe duty motor
Max +	Blue Chip Series XRI-841 motor (IEEE841 compliant)
	Automotive duty "T" Frame
	Blue Chip Series explosion proof, XRI® premium efficiency motor
	Globetrotter® IEC metric motors

* Higher carrier frequencies require shorter cable length to obtain normal (50Khrs) insulation life.

VARIABLE SPEED OPERATION

VARIABLE SPEED INFORMATION

Marathon® Vector-Duty and Inverter-Duty motors, unless otherwise stated, are rated for continuous operation in a 40°C ambient and for altitudes up to 3300 feet (1000 meters) above sea level. Special application considerations, such as high or low ambient, intermittent ratings, high altitude, duty cycle rated, extended constant horsepower range, special base speed, voltage or frequency, or any other special requirements, should be reviewed by a factory representative.

It is the responsibility of the startup personnel during commissioning of the VFD/motor system to properly tune the drive to the motor for the specific application. The correct voltage boost and volts/hertz settings are application dependent and unique to each motor design. Procedures for these adjustments should be in your VFD user manual. Many Vector Duty and Inverter Duty motors in this catalog are equipped with thermostats; warranty coverage may be denied if they are not properly utilized.

⚠ WARNING

- Power factor correction capacitors should never be installed between the drive and the motor.



INVERTER DUTY OR INVERTER RATED

“Inverter Duty” (often called “Inverter Rated”) motors are suitable for use with Variable Frequency Drives, as long as operation is within the application guidelines published in this catalog. In general, Marathon three phase, general purpose, NEMA® Design B motors are considered “Inverter Duty”, and meet or exceed the requirements of NEMA MG1, Part 30. As required under Federal law, these motors comply with EPAAct efficiencies when operating from utility power.

Many Marathon motor product lines have been enhanced to facilitate reliable operation on today’s variable speed drives, including wider constant torque speed range (up to 20:1) and improved insulation systems that withstand voltage spikes common with variable frequency operation.

Inverter Duty (Rated) motors are most often used in 10:1 speed range, variable torque or constant torque applications. A vector control is usually required for operation beyond 10:1 CT.

Refer to “Guidelines for Application of General Purpose, Single Speed Three Phase Motors on Variable Frequency Drives” in this section of this catalog for the allowable speed range and cable length restrictions (from VFD to motor). Additional detail regarding a specific product’s capabilities is available on its catalog page, or by consulting your application engineer.

VECTOR DUTY – “Vector Duty” describes a class of motors that are used in conjunction with Open- (without encoder) or Closed-Loop (with encoder) Vector controls, that provide enhanced performance under low speed operating conditions, or in cases where torque (rather than speed) must be controlled. “Vector Duty” motors can be applied to Volts/Hertz (scalar) drives, as well.

The Marathon “MAX” family, consisting of Blue Max®, Black Max® and microMAX™ motors, have been specifically designed for optimal operation on vector or volts/hertz controls. These motors feature a wide constant torque (up to 2000:1) and/or constant horsepower (up to 4:1) speed range and are performance-matched to all current technology IGBT drives. Vector Duty motors meet or exceed the requirements of NEMA MG1, Part 31, and are equipped with an enhanced MAX GUARD® or CR200 insulation system to provide many years of trouble-free service. Consult the catalog page for each product’s capabilities and features. As these motors are specifically designed for operation through an inverter, they are exempt from EPAAct legislation. Model numbers contain the letter “H” in the “Electrical Type” field.

VARIABLE TORQUE LOADS – Applications include fans, blowers and centrifugal pumps. Torque varies as the square of the speed, and horsepower as the cube of the speed. Operation below base speed significantly lightens the load on the motor. While most variable torque applications do not require the motor to operate below half speed, the motor is fully capable of operation to zero speed. Operation above base speed significantly adds to the load on the motor; therefore, a factory representative must review applications requiring variable torque above base speed. Refer to the application chart found on page 14 for use of general purpose three phase motors on variable frequency drives. Marathon microMAX™, Black Max® or Blue Max® motors are not necessarily required for operation of variable torque loads. A bypass circuit is often employed in variable torque applications. If this device is intended to be used, selection of a NEMA Design B motor is recommended, to withstand the inrush current during across-the-line starting.

CONSTANT TORQUE LOADS – Applications include conveyors, elevators, hoists, extruders, positive displacement pumps, mixers and converting equipment. Torque remains constant throughout the range of operation, and extra care should be taken in the proper application of motors, especially at very low speeds. Most constant torque applications don’t require operation below 10:1 (i.e. 6 Hz operation on a 60 Hz motor), but an increasing number of applications historically reserved for servo and/or stepper systems are being served with motors capable of operation beyond 20:1, up to 2000:1 (zero speed, constant torque). Refer to the application chart found on page 17 for use of general purpose three phase motors on variable frequency drives.

Continued on next page.

VARIABLE SPEED OPERATION

CONSTANT TORQUE LOADS (Cont'd.)

Applications requiring greater than 20:1 C.T. are ideal for microMAX™, Black Max® or Blue Max® motors. These motors provide full rated torque within their listed speed range, without exceeding a Class F temperature rating while under inverter power (many operate at Class B). Ratings in this catalog have been developed, based on extensive testing on IGBT inverters, set at a minimum 3 KHz (or equivalent) carrier frequency.

Marathon® vector duty and inverter duty motors are designed for operation at 150% of rated load for one minute, up to the base speed of the motor (overload capability declines to 100% as the motor reaches maximum constant HP speed). These motors accommodate constant horsepower operation to 1-1/2 to 2 times base speed, subject to the motor's maximum safe mechanical speed limit. Refer to the maximum safe mechanical speed chart, as well as the performance section for each motor's capability.

Motors rated for zero RPM continuous duty (1000:1 or 2000:1) must be powered by vector drives to produce rated torque without overheating. Optimum zero speed and low-speed full torque performance may require a closed loop vector drive (with encoder feedback).

CONSTANT HORSEPOWER LOADS – Applications include coil winders, band saws, grinders, and turret lathes. Operation requires the motor to deliver the same horsepower rating, regardless of shaft speed. Torque increases at low speed and decreases at higher speed. Most general purpose motors can deliver constant horsepower up to 1 1/2 times base speed (consult a factory representative to verify performance). However, many constant HP applications require operation to twice base speed, and some, such as coil winders, up to 4 times base speed. microMAX™, Black Max® and Blue Max® motors are designed for 1 1/2 to 2 times base speed, and the wide CHP motors, found in the Marathon SB371 Catalog, deliver up to 4 times constant horsepower performance.

BEARING CURRENTS – As stated in NEMA® MG1-31.4.4.3, to protect a motor from inverter-sourced shaft voltages, either both bearings must be insulated or the motor shaft must be effectively grounded. Regal offers several effective means to protect the bearings from inverter sourced EDM (electrical discharge machining). A shaft grounding device is standard in Blue Max® motors, in frame sizes 444T and larger. Insulating the motor bearings will not prevent damage to bearings of a connected load, and insulated couplings should be employed to protect the load. Adding a ground brush to a motor with insulated bearings will divert motor shaft currents and help protect the bearings of the connected load. At this time, UL policy prohibits the use of ground brushes or insulated bearings in hazardous locations (Div 1 & 2, Zones 1, 2, 21 & 22).

THE MARATHON SOLUTION TO BEARING CURRENTS

A variety of Marathon products have the BCP device. Models are noted with a -P type catalog number, or a "P" footnote features a current mitigation device.



MOTOR GROUNDING - Frames and accessories of all motors must be grounded in accordance with the National Electric Code (NEC) Article 430. Refer to NEC Article 250 for general information on grounding. Proper grounding of inverter-driven motors is essential to protect personnel and livestock from inverter-sourced common mode voltages, which may reach hazardous levels on the frame of ungrounded or poorly grounded motors.

LOW INPUT VOLTAGE – If, due to lower utility supply voltage, the input voltage from the VFD to the motor is lower than the motor's rated voltage, de-rating of the motor's base frequency, horsepower, full load RPM, and constant HP RPM is required. The revised values can be calculated by multiplying by the ratio of the voltage change. For example, to operate a 460 volt motor from an inverter fed by 50 or 60 HZ, 400 volt utility power, the multiplier is 400/460 or 0.87.

The VFD can be reprogrammed to match the new base point values, allowing the motor to provide rated torque at rated current from the new base speed down to its original minimum constant torque speed. The motor's CHP range will begin at the new base frequency and will be shortened by the same ratio as described above.

OVERSPEED CAPABILITY – Maximum safe mechanical speed capability is a function of bearing size and type, lubrication, rotor balancing technique and specifications, air gap, enclosure, frame construction and connection to the driven load. In addition, consideration must be given to ambient noise levels, as operation above base speed will increase motor noise and vibration, and reduce bearing life. Under no circumstances should bearing hub temperature exceed 100°C. Belted loads should not exceed 60 Hz operating RPM by more than 25% (NEMA "TS" shafts are not suitable for belted loads). Due to external cooling fans, TEFC (and Explosion Proof Fan Cooled) motors are limited to 4000 RPM maximum speed.

Regal, through extensive testing in our state-of-the-art laboratory and in actual field experience, has developed a number of high speed motors whose maximum safe mechanical speed exceeds the values in the table below. The following table depicts maximum safe speed limits for continuous operation, direct-coupled, non-explosion proof motors, and does not imply constant horsepower capability. Please consult a factory representative for requirements beyond those listed, or for intermittent duty limits.

Maximum Safe Mechanical Speed Limits (ODP, TENV, DPFV OR TEBC ENCLOSURES) 60 Hz base frequency

Frame Size	2-Pole	4, 6 or 8-Pole
56-184	7200	5400
213-256	5400	4200
284-286	5400	3600
324-326	4000	3600
364-365	4000	2800
404-449	3600	2800
5000 Fr	N/A	CALL
6800 Fr	N/A	CALL

VARIABLE SPEED OPERATION

OTHER APPLICATION CONSIDERATION

For proper selection, the following should be considered:

- Horsepower or torque requirements at various speeds.
- Desired speed range of the load and motor.
- Acceleration and deceleration rate requirements of the process being controlled.
- Starting requirements including the frequency of starting and a description of the load (reflected inertia at the motor, load torque during starting).
- Whether the application is a continuous process or duty cycle of starts, stops and speed changes.
- A general description of the type of application including the environment in which the VFD system components must operate (determines motor enclosure and/or explosion proof classification).
- Description of the available electrical power supply and wiring.
- Special performance requirements, if any.
- Whether the drive will be configured with a by-pass circuit. In case of its deployment, the motor will operate like its fixed speed counterpart and may require a NEMA® B design which limits in-rush current, or selection of a larger motor starter or other protective circuitry.
- Load sharing
- Mounting and other mechanical considerations

Typical Temperature Rise Of Various Enclosures

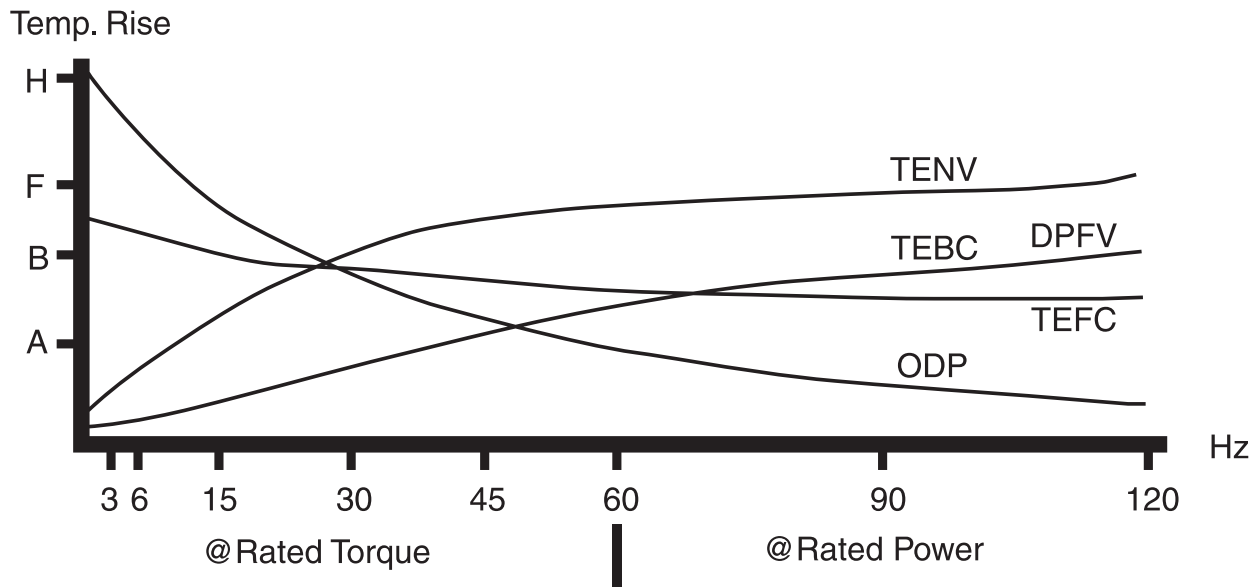

VARIABLE SPEED INFORMATION

GENERAL PURPOSE, SINGLE PHASE MOTORS

(NEMA® SERVICE FACTOR), DRIPPROOF MOTORS

FEATURES:

- Heavy gauge steel frame and base
- Ball bearings (except as noted)
- Economical split phase or capacitor start designs, as noted
- Service factor, as noted
- UL recognized and CSA certified



RIGID BASE

HP	RPM	VOLTS	FRAME	OVER LOAD	CAT. NO.	MODEL NO.	STOCK	LIST PRICE	MULT. SYMB.	FL. AMPS	WT.	"C" DIM.	FOOT NOTES
1/6	1800	115	48	AUTO	4349	5KH39QN9537X	✓	\$228	F1	3.9	12	8.94	3, 20
1/4	1800	115	48	NONE	4354	5KH39QN9538	✓	\$233	F1	5.1	13	8.94	3, 20
	1800	115	48	NONE	H239	5KH33FN6	✓	\$314	F1	5.6	13	8.87	d, 3, 20
	1800	115	48	AUTO	4362	5KH39QN9686X	✓	\$241	F1	5.1	13	8.94	3, 20
	1800	115/230	48	MANUAL	G078A	048B17D11017	✓	\$386	F1	2.4/1.2	17	10.34	1, 20
	1800	115/230	48	NONE	C147A	048B17D11005	✓	\$357	F1	2.4/1.2	17	10.34	1, 20
	1800	115/230	48	AUTO	C148A	048B17D11015	✓	\$485	F1	2.4/1.2	17	10.34	1, 20
1/3	1500	110/220	48	NONE	C431	5KC36LN18	✓	\$438	F1	5.6/2.8	17	9.66	2, 20, 50
	3600	115/230	48	NONE	G091A	048B34D11002	✓	\$269	F1	3.0/1.5	20	10.09	1, 20
	1800	115/230	48	NONE	C153A	048B17D11004	✓	\$513	F1	3.8/1.9	20	10.59	1, 20
	1800	115/230	48	AUTO	C154A	048B17D11010	✓	\$536	F1	3.8/1.9	20	10.59	1, 20
	1800	115/230	56	NONE	C158A	056B17D11019	✓	\$434	F1	3.8/1.9	21	10.97	1, 20
	1800	115/230	56	NONE	E253A	056B17D11020	✓	\$547	F1	3.65/1.8	21	10.97	ES, 1, 20
	1800	115/230	56	AUTO	C159A	056B17D11037	✓	\$449	F1	3.8/1.9	21	10.97	1, 20
	1800	115/230	56	MANUAL	G095A	056B17D11034	✓	\$462	F1	3.8/1.9	21	10.97	1, 20
1/2	1200	115/230	56	NONE	C1252A	056B11D11003	✓	\$566	F1	3.4/1.7	26	11.97	1, 20
	3600	115/230	48	NONE	G1098A	048B34D11003	✓	\$301	F1	4.4/2.2	20	10.59	1, 19
	3600	115/230	56	MANUAL	C1474A	056B34D11021	✓	\$507	F1	4.4/2.2	21	10.97	1, 17
	3000	110/220	48	NONE	C459	5KC37MN96	✓	\$478	F1	7.8/3.9	20	10.06	2, 19, 50
	1800	115/230	48	NONE	C164A	048B17D11003	✓	\$634	F1	4.6/2.3	22	11.09	1, 19
	1800	115/230	56	NONE	E262A	056B17D11022	✓	\$642	F1	4.4/2.2	23	11.47	ES, 1, 19
	1800	115/230	56	NONE	C167A	056B17D11018	✓	\$424	F1	4.6/2.3	23	11.47	1, 19
	1800	115/230	56	AUTO	C168A	056B17D11030	✓	\$529	F1	4.6/2.3	23	11.47	1, 19
	1200	115/230	56	NONE	C1263A	056B11D15505	✓	\$759	F1	5.6/2.8	35	12.12	1, 19
	3/4	3600	115/230	56	NONE	G915A	056B34D11019	✓	\$390	F1	7.2/3.6	25	11.47
3600		115/230	56	MANUAL	C1475A	056B34D11022	✓	\$614	F1	7.2/3.6	52	11.47	1, 19
1800		115/230	56	NONE	EG271A	056B17D15551	✓	\$921	F1	6.4/3.2	41	13.12	ES, 1, 19
1800		115/230	56	NONE	C175A	056B17D15545	✓	\$606	F1	6.6/3.3	42	13.12	1, 19
1800		115/208-230	56	AUTO	C176A	056B17DRR70004A1	✓	\$700	F1	6.6/3.5-3.3	27	12.49	1, 19
1800		115/208-230	56	MANUAL	G919A	056B17DRR70011A1	✓	\$661	F1	6.6/3.5-3.3	25	12.49	1, 19
1800		115/208-230	56	MANUAL	C1298	5KC46NN0758Y	✓	\$551	F1	11.2/5.8-5.6	25	10.34	d, 2, 19
1800		115/208-230	56	MANUAL	C1298A	056B17DRR70012A1	✓	\$757	F1	6.6/3.5-3.3	25	12.49	1, 19
1800		115/208-230	56	MANUAL	C177A	056B17DRR70010A1	✓	\$743	F1	6.6/3.5-3.3	25	12.49	1, 19
1200		115/230	56	NONE	C178A	056B11D15506	✓	\$1,060	F1	6.5/3.25	45	13.62	ES, 1, 18
1	3600	115/230	56	NONE	C179A	056B34D11014	✓	\$505	F1	8.8/4.4	30	12.31	1, 19
	3600	115/230	56	AUTO	C180A	056B34D99007	✓	\$647	F1	8.8/4.4	31	12.33	1, 19
	3600	115/230	56	MANUAL	C702A	056B34D99009	✓	\$778	F1	8.8/4.4	31	12.33	1, 18
	1800	115/230	56H	NONE	E280A	056B17D15549	✓	\$657	F1	8.2/4.1	49	13.12	ES, 1, 18
	1800	115/230	56	NONE	C181A	056B17D15542	✓	\$657	F1	8.4/4.2	42	13.12	1, 18
	1800	115/208-230	56	AUTO	C182A	056B17DRR70017A1	✓	\$698	F1	8/4.4-4	31	12.49	1, 18
	1800	115/208-230	143T	NONE	C188A	143C17DRR40001A1	✓	\$547	S1	13.4/6.7-6.7	31	12.36	2, 11, 18
	1200	115/230	182T	NONE	I141A	182TCDW17084	✓	\$915	S1	15.6/7.8	83	14.19	2, 13, 18

Catalog numbers (Cat No.) highlighted in bold blue have efficiency levels that meet the USA efficiency legislations.

Continued on next page.

SINGLE PHASE

GENERAL PURPOSE, SINGLE PHASE MOTORS

(NEMA® SERVICE FACTOR), DRIPPROOF MOTORS

RIGID BASE

HP	RPM	VOLTS	FRAME	OVER LOAD	CAT. NO.	MODEL NO.	STOCK	LIST PRICE	MULT. SYMB.	F.L. AMPS	WT.	"C" DIM.	FOOT NOTES
1 1/2	3600	115/230	56	NONE	G937A	056B34D11012	✓	\$676	F1	13.6/6.8	35	12.93	1, 18
	3600	115/230	56	MANUAL	C1477A	056B34D99008	✓	\$695	F1	13.2/6.6	36	12.95	1, 18
	3600	115/208-230	143T	NONE	I101	143TCDR5303		\$583	S1	18.8/9.7-9.4	30	10.99	2, 14, 18
	1800	115/230	56H	NONE	C185A	056B17D15548	✓	\$781	F1	12.6/6.3	45	13.62	ES, 1, 18
	1800	115/208-230	56H	AUTO	C186A	056B17DRR70022A1	✓	\$811	F1	12.6/6.4-6.3	40	13.99	ES, 1, 18
	1800	115/208-230	145T	NONE	C191	5KCR49SN0065	✓	\$661	S1	18.2/9.0-8.7	35	12.30	ES, 1, 18
	1200	115/230	184T	NONE	I142	184TCDR7076		\$1,138	S1	23.0/11.5	72	15.72	2, 13, 18
2	3600	115/230	56	NONE	C187A	056B34D11011	✓	\$811	F1	14.2/7.1	38	12.94	1, 18
	3600	115/230	56	MANUAL	C703A	056B34D15536	✓	\$1,036	F1	17.8/8.9	31	12.69	1, 18
	3600	115/208-230	145T	NONE	I102	145TBDR5302	✓	\$695	S1	19.1/10.6-9.5	35	11.49	1, 18
	1800	115/230	56HZ	NONE	C193A	056B17D15555	✓	\$829	F1	17.6/8.8	50	14.18	ES, 1, 11, 18
	1800	115/208-230	56HZ	AUTO	CG381	5KCR49WN0270T	✓	\$886	F1	22.0/10.9-11.0	44	14.33	ES, 1, 11, 18
	1800	115/208-230	145T	MANUAL	I127	145TBDR5337	✓	\$851	S1	18.8/10.2-9.4	48	13.49	1, 11, 18
	1800	115/208-230	182T	NONE	I112A	182TCDW7026	✓	\$771	S1	23.0/12.3-11.5	62	13.19	2, 13, 18
	1200	115/208-230	213T	NONE	I143	213TCDW7076	✓	\$1,414	S1	30.0/15.5-15.0	138	16.55	2, 18
3	3600	115/230	145T	NONE	C194	5KCR48TN8062	✓	\$972	S1	29.4/14.7	38	13.13	ES, 1, 18
	3600	115/208-230	182T	NONE	I103A	182TCDW7001	✓	\$867	S1	32.0/17.1-16.1	62	13.69	2, 13, 18
	1800	115/208-230	184T	NONE	I113A	184TCDW7026	✓	\$902	S1	34.0/17.4-16.9	78	14.21	2, 13, 18
	1200	230	215T	NONE	I144	215TBDW7079		\$1,948	S1	16.0	134	18.05	1, 18
5	3600	208-230	184T	NONE	I104A	184TBDW17008	✓	\$1,165	S1	24.0-22.0	79	14.69	2, 13, 18
	1800	208-230	184T	NONE	I114A	184TBDW7026	✓	\$1,093	S1	23.0-21.0	82	14.71	1, 13, 18
	1800	208-230	213T	NONE	I117	213TCDW7026		\$1,489	S1	30.5-28.0	108	16.55	2, 18
7 1/2	3600	208-230	184T	NONE	I108A	184TBDW7001	✓	\$1,227	S1	34.0-31.0	103	16.69	1, 13, 18
	3600	208-230	213T	NONE	I105	213TCDW7001	✓	\$1,659	S1	40.0-37.0	102	16.55	2, 18, F
	1800	208-230	215T	NONE	I115	215TBDW7026	✓	\$1,637	S1	37.5-34.5	115	18.05	1, 18
10	3600	208-230	215T	NONE	I106	215TCDW17002	✓	\$2,128	S1	50.0-46.0	193	18.05	2, 18, F
	1800	208-230	215T	NONE	I116	215TBDW7028	✓	\$2,107	S1	49.0-44.0	140	19.30	1, 7, 18

Catalog numbers (Cat No.) highlighted in bold blue have efficiency levels that meet the USA efficiency legislations.



EXTENDED THRU-BOLTS, SPLIT PHASE - STEEL ENDSHIELDS

HP	RPM	VOLTS	FRAME	OVER LOAD	CAT. NO.	MODEL NO.	STOCK	LIST PRICE	MULT. SYMB.	F.L. AMPS	WT.	"C" DIM.	FOOT NOTES
1/4	1800	115	48Z	NONE	H901	5KH32DNA612	✓	\$201	F1	5.1	11	9.83	9, 18, 28
	1800	115	48Z	AUTO	H902	5KH32DNA612X	✓	\$209	F1	5.1	11	9.83	9, 18, 28
1/3	1800	115	48Z	NONE	H903	5KH32FNA611	✓	\$207	F1	5.5	14	9.83	9, 18, 28
	1800	115	48Z	AUTO	H904	5KH32FNA611X	✓	\$215	F1	5.5	12	9.83	9, 18, 28
1/2	1800	115	56Z	NONE	H905	5KH36JNA769	✓	\$244	F1	8.1	16	10.89	10, 18, 28
	1800	115	56Z	AUTO	H906	5KH36JNA769X	✓	\$252	F1	8.1	16	10.89	10, 18, 28
3/4	1800	115	56Z	NONE	H907	5KH37NNA768	✓	\$298	F1	11.2	18	11.29	10, 17
	1800	115	56Z	AUTO	H908	5KH37NNA768X	✓	\$306	F1	11.2	33	11.29	10, 17

GENERAL PURPOSE, SINGLE PHASE MOTORS

DRIPPROOF MOTORS

FEATURES:

- Heavy gauge steel frame and base
- Ball bearings
- Capacitor start / capacitor run designs except as noted
- Service factor, as noted



RIGID BASE

HP	RPM	VOLTS	FRAME	OVER LOAD	CAT. NO.	MODEL NO.	STOCK	LIST PRICE	MULT. SYMB.	FL. AMPS	WT.	"C" DIM.	FOOT NOTES
1/4	1800	115/230	48	None	OB1024ES	Century®	✓	\$510	F1	2.4/1.2	15	10.34	20
	1800	115/230	48	Auto	C157LES	Century	✓	\$580	F1	2.4/1.2	20	10.34	20
	1800	115/230	56	Auto	C199ES	Century	✓	\$518	F1	2.4/1.2	21	10.72	20
	1200	115/230	56	Auto	C202ES	Century	✓	\$758	F1	2.4/1.2	29	11.97	20
1/3	1800	115/230	48	Auto	C102LES	Century	✓	\$637	F1	3.8/1.9	21	10.59	20
	1800	115/230	48	None	C109LES	Century	✓	\$609	F1	3.8/1.9	17	10.59	20
	1800	115/230	56	Auto	C222ES	Century	✓	\$502	F1	3.8/1.9	20	10.97	20
	1800	115/230	56	None	C457ES	Century	✓	\$547	F1	3.8/1.9	25	10.97	20
1/2	3600	115/230	48	None	B172ES	Century	✓	\$387	F1	4.4/2.2	25	10.59	19
	1800	115/230	56	Auto	C460ES	Century	✓	\$736	F1	4.6/2.3	20	11.47	19
	1800	115/230	56	Auto	C630ES	Century	✓	\$571	F1	4.6/2.3	24	11.47	19
	1800	115/230	56	None	C608ES	Century	✓	\$531	F1	4.6/2.3	25	11.47	19
	1800	115/230	56	Manual	C320ES	Century	✓	\$580	F1	4.6/2.3	25	11.47	19
	1200	115/230	56	None	C420ES	Century	✓	\$1005	F1	6.6/3.3	35	12.15	19
3/4	1800	115/230	56	None	C655ES	Century	✓	\$742	F1	6.0/3.0	40	13.15	19
	1800	115/208-230	56	Auto	C658ES	Century	✓	\$760	F1	6.6/3.5-3.3	38	12.49	19
	1800	115/208-230	56	Manual	C323ES	Century	✓	\$803	F1	6.6/3.5-3.3	36	12.49	19
	1800	115/230	56	Auto	C526ES	Century	✓	\$971	F1	6.6/3.3	36	12.49	19
	1200	115/230	56	None	C324ES	Century	✓	\$1,210	F1	6.5/3.25	45	13.62	19
1	3600	115/230	56	None	B671ES	Century	✓	\$696	F1	8.8/4.4	37	12.33	19
	3600	115/230	56	Manual	B702ES	Century	✓	\$728	F1	8.8/4.4	37	12.33	18
	1800	115/230	56H	None	OB1104AV1ES	Century	✓	\$785	F1	8.4/4.2	40	13.21	19
	1800	115/208-230	56H	Auto	OB1104AV2ES	Century	✓	\$845	F1	8/4.4-4.0	37	12.49	19
	1800	115/230	56	None	C695ES	Century	✓	\$785	F1	8.4/4.2	40	13.15	19
	1800	115/208-230	56	Auto	C682ES	Century	✓	\$775	F1	8/4.4-4.0	37	12.49	19
	1800	115/208-230	56	Manual	C774ES	Century	✓	\$870	F1	8/4.4-4.0	37	12.49	19
	1800	115/208-230	143T	None	V100	Century	✓	\$744	S1	15.0/7.2-7.5	35	13.10	2, 18
1 1/2	1800	115/230	56H	None	C689ES	Century	✓	\$949	F1	12.6/6.3	46	13.65	110
	1800	115/208-230	56H	Auto	C688ES	Century	✓	\$906	F1	12.6/6.4-6.3	46	13.99	18
	1800	115/208-230	145T	None	V101	Century	✓	\$851	S1	15.0/7.8-7.5	41	13.80	110
	1800	115/208-230	56	Manual	C775ES	Century	✓	\$1,031	F1	12.6/6.4-6.3	45	13.99	18
2	3600	115/230	56H	None	B734ES	Century	✓	\$858	F1	17.8/8.9	40	12.69	110
	3600	115/230	56	Manual	B177LES	Century	✓	\$1,155	F1	17.8/8.9	40	12.69	18
	1800	115/230	56H	Auto	OB1204ALES	Century	✓	\$886	F1	16/8	48	14.48	18
	1800	115/230	56H	Manual	C210ES	Century	✓	\$1,205	F1	16/8	48	14.48	18
	1800	115/230	182T	None	V200M2	Century	✓	\$1,766	S1	25.0/12.5	60	12.70	2, 18
	1800	115/208-230	145T	None	V102	Century	✓	\$933	S1	20.4/10.0-10.2	42	14.30	18
3	3600	230	56	None	B735ES	Century	✓	\$1,589	F1	11.6	42	13.58	18
	1800	115/230	184T	None	V201M2	Century	✓	\$1,447	S1	34.0/17.0	78	14.70	2, 18
5	3600	230	184T	None	V211M2	Century	✓	\$1,492	S1	25.6	82	14.70	2, 18
	1800	230	184T	None	V209M2	Century	✓	\$1,420	S1	22.0	84	15.00	18
	1800	230/460	213T	None	V304M2	Century	✓	\$2,880	S1	25.0/12.5	110	15.80	18
7 1/2	3600	230	213T	None	V310M2	Century	✓	\$2,715	S1	39.0	98	15.80	2, 18
	1800	230/460	215T	None	V305M2	Century	✓	\$2,291	S1	32.0/16.0	158	17.30	18
10	3600	230	215T	None	V311M2	Century	✓	\$3,076	S1	42.0	107	17.30	18
	1800	230/460	215T	None	V303M2	Century	✓	\$3,155	S1	38.0/19.0	156	17.90	18

Catalog numbers (Cat No.) highlighted in bold blue have efficiency levels that meet the USA efficiency legislations.

SINGLE PHASE

SPECIAL PURPOSE, SINGLE PHASE MOTORS

(1.0 SERVICE FACTOR), DRIPPROOF MOTORS

FEATURES:

- Ball bearings (unless otherwise noted)
- Heavy gauge steel frame and base
- 1.0 service factor
- Economical split phase or capacitor start designs (as noted)
- UL recognized and CSA certified



RIGID BASE

HP	RPM	VOLTS	FRAME	OVER LOAD	CAT. NO.	MODEL NO.	STOCK	LIST PRICE	MULT. SYMB.	F.L. AMPS	WT.	"C" DIM.	FOOT NOTES	
1/4	1800	115	48	NONE	4351	5KH39QN9542	√	\$179	F1	5.7	13	8.94	d, 3	
	1800	115	48	NONE	S003	048S17D2089	√	\$179	F1	5.7	12	9.09	3	
	1500	110/220	48	AUTO	H689	5KH35JN603X	√	\$367	F1	5.2/2.6	15	9.23	3, 50	
1/3	1800	115	48	AUTO	S026	048S17D2113	√	\$207	F1	6.6	14	9.34	3	
	1800	115	48	NONE	4368	5KH39QN9397	√	\$199	F1	6.2	14	8.94	3	
	1800	115	48	NONE	S006	048S17D2090	√	\$199	F1	6.6	14	9.34	3	
	1800	115	48	NONE	H229	5KH35HN9	√	\$325	F1	6.8	15	9.25	3	
	1800	115/230	48	NONE	S010	048C17D2023	√	\$269	F1	7.0/3.5	15	9.34	2	
	1800	115/230	48	MANUAL	S030A	048B17D11016	√	\$386	F1	3.8/1.9	20	10.59	1	
	1800	115/230	48	AUTO	S011A	048B17D11014	√	\$338	F1	3.8/1.9	20	10.59	1	
	1800	230	48	NONE	4373	5KH39QN9543	√	\$281	F1	3.3	14	8.94	3	
	1800	115	48Z	NONE	4376	5KH39QN9547	√	\$268	F1	6.2	15	10.36	3, 21	
	1800	115	56Z	NONE	4372	5KH39QN9546	√	\$274	F1	6.2	15	8.94	3, 7	
	1800	115	56Z	NONE	H676	5KH35GNA229	√	\$325	F1	6.2	14	9.57	3, 7	
	1800	115/230	56	MANUAL	CG105A	056B17D11038	√	\$462	F1	3.8/1.9	21	10.97	1	
	1500	110/220	48	AUTO	H691	5KH36LN488X	√	\$392	F1	7.0/3.5	17	9.66	3, 7	
	1/2	1800	115	48	NONE	H696	5KH36LNA504	√	\$387	F1	8.3	15	9.68	3
		1800	115	56	AUTO	S027	056S17D2066	√	\$265	F1	9.2	19	10.22	3
1800		115	56	NONE	H230	5KH39QN9091	√	\$253	F1	8.3	16	10.32	3, 7	
1800		115	56	NONE	S022	056S17D2046	√	\$253	F1	9.2	17	10.22	3	
1800		115/230	56	NONE	S012	056C17D2098	√	\$332	F1	9.2/4.6	18	10.22	2	
1800		115/230	56	MANUAL	S033A	056B17D11028	√	\$462	F1	4.6/2.3	23	11.47	1	
1800		115/230	56	AUTO	S013A	056B17D11042	√	\$414	F1	4.6/2.3	23	11.47	1	
1800		115/230	56Z	NONE	CG393	5KC36MN20	√	\$465	F1	8.2/4.1	17	12.30	2	
3600		115/230	48	NONE	CG111	5KC37LN91	√	\$663	F1	11.2/5.6	19	10.06	2	
3/4	1800	115/208-230	56	MANUAL	S036A	056B17DRR70009A1	√	\$543	F1	6.6/3.5-3.3	25	12.49	1	
	1800	115/208-230	56	AUTO	S015A	056B17DRR70007A1	√	\$496	F1	6.6/3.5-3.3	24	12.49	1	
	1800	115/230	56	NONE	S014	056C17D2054	√	\$397	F1	10.4/5.2	24	11.97	2	
	1800	115/230	56Z	NONE	C449	5KC37NN160	√	\$521	F1	13.4/6.7	20	12.60	2	
1	3600	115/230	56Z	NONE	C449	5KC37NN160	√	\$521	F1	13.4/6.7	20	12.60	2	
	1800	115/208-230	56	MANUAL	S039A	056B17DRR70020A1	√	\$706	F1	8/4.4-4	37	12.49	1	
	1800	115/208-230	56	AUTO	S038A	056B17DRR70018A1	√	\$657	F1	8/4.4-4	37	12.49	1	
	1800	115/230	56	NONE	S037	056C17D5319	√	\$534	F1	13.6/6.8	28	10.94	2	
1 1/2	3600	115/208-230	48	MANUAL	9034A	-	√	\$500	F1	13.2/6.6	17	10.34	1	
3	3600	208-230	145T	NONE	I145	145TBDR5303	√	\$752	S1	13.5/12.5	40	12.49	1	

Catalog numbers (Cat No.) highlighted in bold blue have efficiency levels that meet the USA efficiency legislations.

GENERAL PURPOSE, SINGLE PHASE MOTORS

(NEMA® SERVICE FACTOR), DRIPPROOF MOTORS

FEATURES:

- Ball bearings mechanically locked on shaft end (excludes 5K models)
- Heavy gauge steel frame and base
- Capacitor start design for high starting torque, as noted
- Capacitor start/capacitor run design for higher efficiency
- Service factor, as noted
- UL recognized and CSA certified



C-FACE FOOTLESS

HP	RPM	VOLTS	FRAME	OVER LOAD	CAT. NO.	MODEL NO.	STOCK	LIST PRICE	MULT. SYMB.	F.L. AMPS	WT.	"C" DIM.	FOOT NOTES
1/4	1800	115/230	56C	NONE	G212A	056B17D11015	√	\$354	F1	2.4/1.2	17	10.69	20
	1800	115/230	56C	AUTO	C354A	056B17D11039	√	\$507	F1	2.4/1.2	17	10.31	20
1/3	3600	115/230	56C	NONE	G216A	056B34D11018	√	\$290	F1	3.0/1.5	17	10.44	20
	1800	115/230	56C	NONE	E251A	056B17D11021	√	\$653	F1	3.65/1.8	19	10.94	ES, 20
	1800	115/230	56C	AUTO	C356A	056B17D11036	√	\$587	F1	3.8/1.9	19	10.56	20
	1800	115/230	56C	NONE	G230A	056B17D11014	√	\$453	F1	3.8/1.9	19	10.94	20
1/2	3600	115/230	56C	NONE	G232A	056B34D11017	√	\$365	F1	4.4/2.2	20	10.94	19
	1800	115/230	56C	NONE	E260A	056B17D11023	√	\$744	F1	4.4/2.2	25	11.44	ES, 19
	1800	115/230	56C	NONE	G234A	056B17D11017	√	\$512	F1	4.6/2.3	25	11.44	19
	1800	115/230	56C	AUTO	C359A	056B17D11033	√	\$666	F1	4.6/2.3	25	11.44	19
	1200	115/208-230	56C	NONE	C1422A	056B11D15504	√	\$808	F1	5.6/2.8	32	12.15	19
3/4	3600	115/230	56C	NONE	G238A	056B34D11016	√	\$410	F1	7.2/3.6	23	11.44	19
	1800	115/230	56C	NONE	E269A	056B17D15550	√	\$921	F1	6.4/3.2	41	13.06	ES, 19
	1800	115/208-230	56C	AUTO	CG362A	056B17DRC70002A1	√	\$802	F1	6.6/3.5-3.3	25	12.31	19
	1800	115/230	56C	NONE	CG361A	056B17D15544	√	\$572	F1	6.6/3.3	42	13.06	19
1	3600	115/230	56C	NONE	G254A	056B34D11015	√	\$537	F1	8.8/4.4	32	12.31	19
	1800	115/208-230	56C	AUTO	CG363A	056B17DRC70005A1	√	\$896	F1	8/4.4-4	34	12.31	18
	1800	115/230	56C	NONE	G256A	056B17D15543	√	\$701	F1	8.4/4.2	41	13.06	18
1 1/2	3600	115/230	56C	NONE	G258A	056B34D11013	√	\$610	F1	13.6/6.8	48	12.93	18
	1800	115/230	56C	NONE	G270A	056B17D15541	√	\$816	F1	12.6/6.3	46	13.68	18
2	3600	115/230	56C	NONE	G272A	056B34D15528	√	\$747	F1	19.1/9.5	39	13.18	18
	1800	115/230	56C	NONE	G274A	056B17D15554	√	\$955	F1	12.6/6.3	54	14.06	18
3	3600	115/208-230	182TC	NONE	C173	182TCDR8007	√	\$953	S1	32.0/19.0-16.0	76	13.96	2, 18

Catalog numbers (Cat No.) highlighted in bold blue have efficiency levels that meet the USA efficiency legislations.

GENERAL PURPOSE, SINGLE PHASE MOTORS

DRIPPROOF MOTORS

FEATURES:

- Heavy gauge steel frame and base
- Ball bearings
- Capacitor start/capacitor run designs
- Service factor, as noted



HP	RPM	VOLTS	FRAME	OVER LOAD	CAT. NO.	MODEL NO.	STOCK	LIST PRICE	MULT. SYMB.	F.L. AMPS	WT.	"C" DIM.	FOOT NOTES
1/3	1800	115/230	56C	None	K1034LV1	Century®	√	\$532	F1	6.8/3.4	23	10.60	113
1/2	1800	115/230	56C	None	C315ES	Century	√	\$663	F1	4.6/2.3	25	11.44	19
	1800	115/230	56C	Auto	C635ES	Century	√	\$709	F1	4.6/2.3	25	11.44	19
3/4	1800	115/230	56C	None	C316ES	Century	√	\$904	F1	8.4/4.1	38	13.08	19
	1800	115/208-230	56C	Auto	C665ES	Century	√	\$930	F1	6.6/3.5-3.3	36	12.31	19
1	1800	115/230	56C	None	C445ES	Century	√	\$973	F1	8.4/4.2	38	13.08	19
2	1800	115/208-230	145TC	None	V108	Century	√	\$893	F1	20.4/10.0-10.2	42	13.85	18

Catalog numbers (Cat No.) highlighted in bold blue are premium efficient.

GENERAL PURPOSE, SINGLE PHASE MOTORS

(NEMA® SERVICE FACTOR), DRIPPROOF MOTORS

FEATURES:

- Ball bearings, mechanically locked on shaft end (excludes 5K models)
- NEMA service factors
- Heavy gauge steel frame and base
- Capacitor start/capacitor run design for higher efficiency
- UL recognized and CSA certified



C-FACE FOOTED (RIGID BASE)

HP	RPM	VOLTS	FRAME	OVER LOAD	CAT. NO.	MODEL NO.	STOCK	LIST PRICE	MULT. SYMB.	F.L. AMPS	WT.	"C" DIM.	FOOT NOTES
1/4	1800	115/230	56C	AUTO	K234A	056B17D11040		\$415	F1	2.4/1.2	21	10.69	20
1/3	1800	115/230	56C	AUTO	K235A	056B17D11035	√	\$481	F1	3.8/1.9	21	10.94	20
	1800	115/230	56C	MANUAL	E250A	056B17D11041	√	\$507	F1	3.65/1.8	21	10.94	20
	1800	100-120/200-240	56C	AUTO	E252A	056B17D11032	√	\$582	F1	3.8-3.65/1.9-1.8	21	10.94	20
1/2	1800	100-120/200-240	56C	AUTO	E261A	056B17D11029	√	\$491	F1	5.2-4.4/2.6-2.2	25	11.44	19
	1800	100-120/200-240	56C	MANUAL	E259A	056B17D11031		\$588	F1	5.2-4.4/2.6-2.2	25	11.44	19
3/4	1800	100-120/200-240	56C	AUTO	E270A	056B17DRR70005A1	√	\$681	F1	6.8-6.2/3.4-3.1	25	12.31	19
	1800	115/230	56C	MANUAL	E268A	056B17DRR70008A1	√	\$775	F1	6.2/3.1	35	12.31	19
1	1800	115/230	56C	MANUAL	EG277A	056B17DRR70019A1		\$1,010	F1	7.6/3.8	35	12.31	18
2	3600	115/230	56C	MANUAL	C1269A	056B34D15537	√	\$1,068	F1	17.8/8.9	31	12.69	18
3	3600	230	56C	MANUAL	C1270A	056B34D15538	√	\$1,094	F1	11.6	45	—	18

Catalog numbers (Cat No.) highlighted in bold blue have efficiency levels that meet the USA efficiency legislations.

GENERAL PURPOSE, SINGLE PHASE MOTORS

DRIPPROOF MOTORS

FEATURES:

- Heavy gauge steel frame and base
- Ball bearings
- Capacitor start/capacitor run designs
- Service factor, as noted



C-FACE FOOTED (RIGID BASE)

HP	RPM	VOLTS	FRAME	OVER LOAD	CAT. NO.	MODEL NO.	STOCK	LIST PRICE	MULT. SYMB.	F.L. AMPS	WT.	"C" DIM.	FOOT NOTES
1/3	3600	115/230	56C	Auto	B416ES	Century®	√	\$399	F1	3.0/1.5	19	10.44	20
1/2	3600	115/230	56C	Auto	B513ES	Century	√	\$413	F1	4.4/.2.2	22	10.94	19
	1800	115/230	56C	None	C335ES	Century	√	\$702	F1	4.6/2.3	25	11.44	19
3/4	3600	115/230	56C	Auto	B652ES	Century	√	\$487	F1	7.2/3.6	27	11.44	19
1	3600	115/230	56C	Auto	B672ES	Century	√	\$621	F1	12.8/6.4	30	12.33	18
1 1/2	3600	115/230	56C	Auto	B753ES	Century	√	\$808	F1	13.2/6.6	31	12.33	18
	1800	115/230	56C	Manual	C776ES	Century	√	\$1,130	F1	12.6/6.3	37	13.81	18
2	3600	115/230	56C	Manual	B860ES	Century	√	\$1,077	F1	17.8/8.9	31	12.70	18
5	3600	230	184TC	None	V203M2	Century	√	\$2,504	S1	25.4	101	16.21	2, 18

Catalog numbers (Cat No.) highlighted in bold blue are premium efficient.

GENERAL PURPOSE, SINGLE PHASE MOTORS

TOTALLY ENCLOSED MOTORS

FEATURES:

- Ball bearings
- Heavy gauge steel constructions
- Economical split phase or capacitor start designs, as noted
- Service factor, as noted
- UL recognized and CSA certified



RIGID BASE

HP	RPM	VOLTS	FRAME	OVER LOAD	CAT. NO.	MODEL NO.	STOCK	LIST PRICE	MULT. SYMB.	F.L. AMPS	WT.	"C" DIM.	FOOT NOTES
1/6	1800	115	48	NONE	H116	5KH32EN66	✓	\$362	F1	4.0	15	9.92	3, 17
	900	115/230	56	NONE	C248	5KC49PN3036	✓	\$942	F1	5.6/2.8	28	12.43	2, 17
1/4	1800	115	48	AUTO	HG121	5KH32FN3123X	✓	\$397	F1	5.1	15	9.92	3, 17
	1800	115	48	NONE	HG120	5KH32FN3123	✓	\$379	F1	5.1	15	9.92	3, 17
	1800	115/230	48	AUTO	C243	5KC32GN9X	✓	\$469	F1	5.4/2.7	17	10.00	2, 17
	1800	115/230	48	NONE	C242	5KC32GN9	✓	\$448	F1	5.4/2.7	17	10.00	2, 17
	1800	230	48	AUTO	H243	5KH32GN68X	✓	\$434	F1	2.7	17	9.92	3, 17
	1500	110/220	48	NONE	C462	5KC33KN19	✓	\$518	F1	5.4/2.7	18	10.17	2, 17, 50
	1800	115/208-230	56	MANUAL	G314	056C17F2052	✓	\$375	F1	4.2/2.1-2.1	20	10.22	2, 18
	1800	115/230	56	AUTO	CG251	5KC32GN19X	✓	\$488	F1	5.4/2.7	17	10.38	2, 17
	1800	115/230	56	NONE	G1312	5KC32GN19	✓	\$349	F1	5.4/2.7	16	10.38	2, 17
	1200	115/230	56	NONE	G1316	5KC49MN6061	✓	\$529	F1	6.2/3.1	27	11.43	2, 17
1/3	3600	115	48	AUTO	HG124	5KH33FN85X	✓	\$414	F1	6.4	16	10.17	3, 17
	3600	115	48	NONE	HG123	5KH33FN85	✓	\$402	F1	6.4	16	10.17	3, 17
	1800	115/230	56	AUTO	G1331	5KC35MN43X	✓	\$406	F1	6.0/3.0	20	10.93	2, 18
	1800	115/208-230	56	MANUAL	G332	056C17F2049	✓	\$430	F1	6.0/3.0-3.0	20	10.47	2, 18
	1800	100-120/200-400	56	NONE	E258	5KCR46JN0089	✓	\$625	F1	4.0-3.8/2.0-1.9	25	11.83	ES, 1, 20
	1800	115/230	56	NONE	G1330	5KC35MN43	✓	\$390	F1	6.0/3.0	17	10.93	2, 18
	1200	115/230	56	NONE	C1333	5KC49PN6062	✓	\$596	F1	8.6/4.3	31	12.43	2, 18
1/2	3600	115/208-230	56	MANUAL	G393	056C34F5307	✓	\$363	F1	8.4/4.0-4.2	22	11.82	2, 14, 18
	3600	115/208-230	56	NONE	K339	056C34F5327	✓	\$339	F1	8.4/4.0-4.2	23	11.82	2, 14, 18
	1800	100-120/200-240	56	NONE	E267	5KCR46MN0094	✓	\$711	F1	5.8-5.6/2.9-2.8	27	11.83	ES, 1, 19
	1800	115/230	56	AUTO	C262	5KC42GN0014X	✓	\$467	F1	8.6/4.3	21	11.00	2, 18
	1800	115/208-230	56	MANUAL	G339	056C17F2051	✓	\$496	F1	8.0/4.0-4.0	23	11.22	2, 18
	1800	115/230	56	NONE	C261	5KC42GN0014	✓	\$440	F1	8.6/4.3	21	11.00	2, 18
	1800	115/230	48	NONE	CG260	5KC37RN35	✓	\$575	F1	8.8/4.4	23	11.38	2, 17
	1200	115/230	56	NONE	C264	5KC49UN6065	✓	\$755	F1	9.4/4.7	40	12.96	2, 18
3/4	3600	115/208-230	56	MANUAL	G379	056C34F5309	✓	\$441	F1	10.6/5.3-5.3	26	12.32	2, 14, 18
	3600	115/208-230	56	NONE	G352	056C34F5308	✓	\$414	F1	10.6/5.3-5.3	26	12.32	2, 14, 18
	1800	100-120/200-240	56	NONE	EG276	5KCR49PN0101	✓	\$792	F1	9.0-8.8/4.5-4.4	31	12.43	ES, 1, 7, 19
	1800	115/230	56	AUTO	C269	5KC46PN0015X	✓	\$572	F1	10.4/5.2	31	11.83	2, 17
	1800	115/208-230	56	MANUAL	G356	056C17F5308	✓	\$609	F1	11.0/5.4-5.5	29	12.32	2, 14, 18
	1800	115/208-230	56	NONE	C268	5KC46PN0015	✓	\$542	F1	11.0/5.4-5.5	31	11.83	2, 18
	1200	115/230	56	NONE	C271	5KCR48WN6066	✓	\$902	F1	10.6/5.3	44	13.82	ES, 1, 17
	1200	115/208-230	143T	NONE	I707	143TBFR5376	✓	\$942	S1	11.4/5.8-5.7	42	13.87	1, 14, 18
1	3600	115/208-230	56	NONE	G359	056C34F5310	✓	\$475	F1	12.4/6.7-6.2	30	12.32	2, 14, 18
	3600	115/230	56	AUTO	C273	5KC49NN2130X	✓	\$499	F1	13.0/6.5	29	12.43	2, 17
	3600	115/208-230	56	MANUAL	G390	056C34F5311	✓	\$499	F1	12.4/6.7-6.2	31	12.32	2, 14, 18
	3600	115/230	56	MANUAL	C274	5KC49NN2130Y	✓	\$499	F1	13.0/6.5	21	12.43	2, 17
	1800	115/230	56	NONE	C275	5KC49TN0034	✓	\$610	F1	13.2/6.6	38	12.96	2, 18
	1800	100-120/200-240	56	NONE	E285	5KCR49UN0108	✓	\$910	F1	11.8-11.4/5.9-5.7	40	12.96	ES, 1
	1800	115/208-230	56	MANUAL	G373	056C17F5311	✓	\$638	F1	13.4/6.8-6.7	30	12.82	2, 14, 18
	1800	115/230	56	AUTO	C276	5KC49TN0034X	✓	\$625	F1	13.2/6.6	36	12.96	2, 17
	1800	115/230	143T	NONE	C295	5KC49TN0033	✓	\$638	S1	13.2/6.6	38	13.33	2, 17
	1 1/2	3600	115/208-230	56H	MANUAL	G391	056B34F5321	✓	\$653	F1	14.2/7.7-7.1	33	12.82
3600		115/208-230	56H	NONE	G374	056B34F5320	✓	\$609	F1	14.2/7.7-7.1	32	12.82	1, 5, 14
3600		115/208-230	143T	NONE	I220	143TBFR5301	✓	\$676	S1	14.2/7.7-7.1	33	12.87	1, 14, 18
1800		115/208-230	56H	MANUAL	G378	056B17F5302	✓	\$732	F1	15.2/8.2-7.6	40	13.82	1, 5, 14, 18
1800		115/208-230	56H	NONE	G1376	5KCR48WN0273	✓	\$695	F1	14.5/7.1-7.3	44	13.82	ES, 1, 5, 18
1800		115/208-230	56H	AUTO	G1377	5KCR48WN0273X	✓	\$719	F1	14.5/7.1-7.3	44	13.82	ES, 1, 5, 18
1800		115/208-230	145T	MANUAL	I201	145TBFR5327	✓	\$808	S1	15.2/8.2-7.6	41	13.87	1, 14, 18
1800		115/208-230	145T	NONE	C297	5KCR48WN0292	✓	\$717	S1	14.5/7.1-7.3	44	14.07	1, 18

Continued on next page.

GENERAL PURPOSE, SINGLE PHASE MOTORS

TOTALLY ENCLOSED MOTORS

RIGID BASE

HP	RPM	VOLTS	FRAME	OVER LOAD	CAT. NO.	MODEL NO.	STOCK	LIST PRICE	MULT. SYMB.	F.L. AMPS	WT.	"C" DIM.	FOOT NOTES
2	3600	115/230	56	MANUAL	G1392	5KCR49TN2139U	✓	\$740	F1	17.8/8.9	38	14.27	ES, 1, 18
	3600	115/208-230	56H	NONE	K350	056B34F5322		\$712	F1	18.0/10.0-9.0	38	13.32	1, 5, 14, 18
	3600	115/208-230	145T	NONE	I221	145TBFR5303	✓	\$740	S1	18.0/10.0-9.0	39	13.37	1, 14, 18
	1800	115/230	145T	NONE	I700	145TBFR5334	✓	\$904	S1	18.8/9.4	50	14.87	1, 14, 18
	1800	115/208-230	182T	NONE	I212	182TBFR5326	✓	\$977	S1	20.0/10.8-10.0	52	15.65	F, 1, 18
3	3600	115/208-230	182T	NONE	I206	182TBFR5301	✓	\$1,138	S1	24.6/13.9-12.3	57	15.81	1, 17
	3600	208-230	145T	NONE	I204	145TBFR5301		\$1,007	S1	13.1-11.8	50	14.87	1, 14, 18
	3600	208-230	145T	MANUAL	I205	145TBFR5302		\$1,084	S1	13.1-11.8	50	14.87	1, 14, 18
	1800	115/208-230	184T	NONE	I213A	184TBFV17044	✓	\$1,165	S1	28.4/14.8-14.2	72	14.96	1, 13, 14, 17
5	3600	208-230	184T	NONE	I223A	184TBFV7701	✓	\$1,454	S1	22.0-19.8	98	16.49	1, 13, 14, 17
	1800	208-230	184T	NONE	I214A	184TBFV7726	✓	\$1,434	S1	21.5-19.5	103	17.46	1, 13, 14, 18
	1800	208-230	213T	NONE	I216	213TBFV7026	✓	\$1,548	S1	24.5-22.0	106	18.73	1, 14, 17
7 1/2	3600	208-230	213T	NONE	I224	213TBFV7001	✓	\$1,951	S1	36.0-32.0	112	20.23	1, 14, 17
	1800	208-230	215T	NONE	I215	215TBFV7026	✓	\$1,905	S1	35.0-30.0	133	21.48	1, 14, 17, F
10	3600	208-230	215T	NONE	I225	215TBFV7001	✓	\$2,376	S1	44.0-41.5	141	20.23	1, 14, 17, F
	1800	230	215T	NONE	I217	215TBFV7027	✓	\$2,443	S1	41.5	144	21.48	1, 14, 17

GENERAL PURPOSE, SINGLE PHASE MOTORS

TOTALLY ENCLOSED MOTORS

FEATURES:

- Heavy gauge steel construction
- Ball bearings
- Service factor as noted
- TENV as noted
- Capacitor start / induction run designs
- Capacitor start / capacitor run designs as noted



HP	RPM	VOLTS	FRAME	OVER LOAD	CAT. NO.	MODEL NO.	STOCK	LIST PRICE	MULT. SYMB.	F.L. AMPS	WT.	"C" DIM.	FOOT NOTES
1/4	1800	115/230	48	None	C198L	Century®	✓	\$525	F1	3.6/1.8	20	10.4	N, 17
	1800	115/208-230	56	Auto	C664	Century	✓	\$559	F1	3.8/2.0-1.9	25	11.1	N, 18
1/3	3600	115/208-230	56	None	B412	Century	✓	\$458	F1	4.8/2.5-2.4	22	10.1	N, 18
	1800	115/230	48	None	C150L	Century	✓	\$531	F1	4.3/1.7	22	10.8	N, 17
	1800	115/230	48	Auto	C151L	Century	✓	\$555	F1	4.6/2.3	18	9.9	N, 17
	1800	115/208-230	56	None	C220V1	Century	✓	\$560	F1	5.2/2.5-2.6	27	11.1	N, 18
	1800	115/208-230	56	Auto	C223V1	Century	✓	\$563	F1	5.2/2.5-2.6	26	11.1	N, 18
	1800	115/208-230	56	None	C612	Century	✓	\$621	F1	7.2/3.5-3.6	28	12.2	18
1/2	1800	115/208-230	56	Auto	C613	Century	✓	\$669	F1	7.2/3.5-3.6	28	12.2	18
	1200	115/208-230	56	None	C322	Century	✓	\$1,019	F1	8.4/4.0-4.2	35	13.4	18
	3600	208-230/115	56	None	B664	Century	✓	\$526	F1	5.0-4.6/9.2	30	12.2	18
3/4	1800	208-230/115	56	None	C669	Century	✓	\$743	F1	5.4-5.2/10.4	33	12.6	18
	1800	208-230/115	56	Auto	C671	Century	✓	\$791	F1	5.4-5.2/10.4	33	12.6	18
	3600	208-230/115	56	Manual	B695	Century	✓	\$675	F1	6.1-6.0/12.0	32	12.2	18
1	1800	208-230/115	56	None	C683	Century	✓	\$823	F1	7.2-7.5/15.0	34	13.4	18
	1800	208-230/115	56	Auto	C685	Century	✓	\$844	F1	6.2-6.0/12.0	38	13.4	18
	1800	208-230/115	56	Manual	C620	Century	✓	\$862	F1	6.2-6.0/12.0	37	13.4	18
	1800	208-230/115	143T	None	K100V1	Century	✓	\$788	S1	7.7-7.5/15.0	37	13.7	18
	3600	208-230/115	56	Manual	B696	Century	✓	\$859	F1	8.3-8.0/16.0	36	12.6	18
1 1/2	1800	208-230/115	56H	None	C693	Century	✓	\$994	F1	7.7-7.5/15.0	44	13.9	1, 18
	1800	208-230/115	56H	Auto	C686	Century	✓	\$1,011	F1	7.8-7.5/15.0	45	13.9	1, 18
	1800	208-230/115	145T	None	K101V1	Century	✓	\$848	S1	7.7-7.5/15.0	43	15.0	1, 18
	3600	208-230/115	56H	Manual	B697	Century	✓	\$1,008	F1	9.1-8.4/16.6	40	14.4	1, 18
2	1800	115/230	182T	None	K200M2	Century	✓	\$1,121	S1	24.0/12.0	76	18.0	17
	3600	115/230	184T	None	K222M2	Century	✓	\$2,146	S1	32.0/16.0	98	17.9	17
3	1800	115/230	184T	None	K203M2	Century	✓	\$1,278	S1	33.6/16.8	83	15.9	17
	3600	230	184T	None	K223M2	Century	✓	\$2,080	S1	19.8	155	17.9	1, 17
7 1/2	1800	230/460	215T	None	K305M2	Century	✓	\$2,308	S1	34.0/17.0	138	19.1	1, 17
10	3600	230	215T	None	K315M2	Century	✓	\$3,704	S1	40.0	126	19.1	1, 17

GENERAL PURPOSE, SINGLE PHASE MOTORS

TOTALLY ENCLOSED MOTORS

FEATURES:

- Ball bearings mechanically locked on shaft end (excludes 5K models)
- Heavy gauge steel constructions
- Suitable for horizontal or vertical mounting
- Economical split phase or capacitor start designs, as noted
- Will accept brake kits, see accessory section (except as noted)
- Service factor, as noted
- UL recognized and CSA certified



C-FACE FOOTLESS

HP	RPM	VOLTS	FRAME	OVER LOAD	CAT. NO.	MODEL NO.	STOCK	LIST PRICE	MULT. SYMB.	F.L. AMPS	WT.	"C" DIM.	FOOT NOTES
1/6	1800	115	56C	NONE	H244	5KH32EN124	✓	\$441	F1	4.0	10	10.30	3, 17, 24
1/4	1800	115/230	56C	NONE	G1511	5KC32GN25	✓	\$368	F1	5.4/2.7	16	10.30	2, 17, 24
1/3	3600	115/230	56C	NONE	C1419	5KC33FN31	✓	\$327	F1	5.6/2.8	14	10.19	18, 24
	1800	100-120/200-240	56C	NONE	E256	5KCR46JN0088	✓	\$665	F1	4.0-3.8/2.0-1.9	25	11.84	ES, 1, 20, 24
	1800	115/230	56C	NONE	G1513	5KC35MN73	✓	\$424	F1	6.0/3.0	19	10.93	2, 18, 24
1/2	3600	115/208-230	56C	NONE	G514	056C34F5322	✓	\$355	F1	8.4/4.0-4.2	23	11.82	2, 18
	3600	115/230	56C	AUTO	C349	5KC36LN166X	✓	\$508	F1	7.4/3.7	19	11.36	2, 18, 24
	1800	100-120/200-240	56C	NONE	E265	5KCR46MN0093	✓	\$746	F1	5.8-5.6/2.9-2.8	27	11.84	ES, 1, 19, 24
	1800	115/230	56C	AUTO	C446	5KC42GN0018X	✓	\$598	F1	8.6/4.3	21	11.01	2, 18, 24
	1800	115/230	56C	NONE	G1515	5KC42GN0018	✓	\$489	F1	8.6/4.3	21	11.01	2, 18, 24
	1200	115/230	56C	NONE	C1404	5KC49UN6067	✓	\$1,026	F1	9.4/4.7	40	12.93	2, 17, 24
3/4	3600	115/208-230	56C	NONE	G516	056C34F5323	✓	\$435	F1	10.6/5.3-5.3	26	12.32	2, 18
	1800	100-120/200-240	56C	NONE	E274	5KCR49PN0100	✓	\$824	F1	9.0-8.8/4.5-4.4	31	12.44	ES, 1, 19, 24
	1800	115/230	56C	NONE	G1517	5KC46PN0032	✓	\$588	F1	11.0/5.5	31	11.84	2, 17, 24
1	3600	115/208-230	56C	NONE	G518	056C34F5324	✓	\$492	F1	12.4/6.7-6.2	29	12.32	2, 18
	3600	115/230	56C	AUTO	C351	5KC49NN2133X	✓	\$649	F1	13.0/6.5	29	12.44	2, 18, 24
	1800	100-120/200-240	56C	NONE	EG283	5KCR49UN0107	✓	\$945	F1	11.8-11.4/5.9-5.7	40	12.97	ES, 1, 18, 24
	1800	115/230	56C	NONE	G1519	5KC49TN0035	✓	\$626	F1	13.2/6.6	36	12.97	2, 17, 24
1 1/2	3600	115/230	56C	NONE	C1424	5KC49SN2158	✓	\$625	F1	16.4/8.2	35	12.93	2, 24, 111
	3600	115/230	56C	AUTO	C855	5KC49SN2156X	✓	\$794	F1	16.4/8.2	35	12.93	2, 17, 24
	1800	115/208-230	56C	NONE	G1531	5KCR48WN0294	✓	\$724	F1	14.5/7.1-7.3	44	13.69	ES, 1, 18 24
2	3600	115/208-230	56C	NONE	G533	056B34F5319	✓	\$759	F1	18.0/10.0-9.0	38	13.32	1, 18
	3600	115/230	56C	AUTO	C466	5KCR49TN2155T	✓	\$972	F1	17.8/8.9	38	14.28	1, 17, 24

GENERAL PURPOSE, SINGLE PHASE MOTORS

TOTALLY ENCLOSED MOTORS

FEATURES:

- Heavy gauge steel frame and base
- Ball bearings
- Capacitor start / induction run designs
- Capacitor start / capacitor run designs as noted
- Service factor as noted
- TENV as noted



C-FACE FOOTLESS

HP	RPM	VOLTS	FRAME	OVER LOAD	CAT. NO.	MODEL NO.	STOCK	LIST PRICE	MULT. SYMB.	F.L. AMPS	WT.	"C" DIM.	FOOT NOTES
1/4	1800	115/230	48	None	C153L	Century®	√	\$532	F1	3.3/1.7	19	10.0	N, 17
	1200	115/208-230	56C	None	C208V1	Century	√	\$714	F1	5.0/2.4-2.5	27	12.2	18
1/3	1800	115/208-230	56C	None	C155	Century	√	\$580	F1	5.2/2.5-2.6	25	11.0	N, 18
	1200	115/208-230	56C	None	C209	Century	√	\$842	F1	6.0/3.0-3.0	32	12.5	18
1/2	3600	115/208-230	56C	None	B519	Century	√	\$484	F1	7.4/3.7-3.7	25	11.3	18
	1800	115/230	56C	Auto	EC1054AV1	Century	√	\$740	F1	6.7/3.35	29	11.2	18, 126
	1800	115/208-230	56C	None	C907	Century	√	\$687	F1	7.2/3.5-3.6	27	12.2	18
3/4	1800	115/208-230	56C	None	C916	Century	√	\$811	F1	10.4/5.4-5.2	31	12.5	18
	1800	115/230	56C	Auto	EC1074AL	Century	√	\$882	F1	11.0/5.5	47	11.7	18
	1200	115/208-230	145TC	None	K108	Century	√	\$880	S1	8.8/4.6-4.4	38	13.4	1, 18
1	3600	115/208-230	56C	None	B793	Century	√	\$654	F1	12.0/6.1-6.0	34	12.2	18
	1800	115/208-230	56C	None	C926	Century	√	\$902	F1	12.0/6.2-6.0	35	13.0	18
1 1/2	3600	115/208-230	56C	None	B794	Century	√	\$807	F1	16.0/8.3-8.0	34	12.7	18
	1800	115/208-230	56C	None	C507	Century	√	\$1,036	F1	15.0/7.7-7.75	43	13.7	1, 18
	1800	115/208-230	145TC	None	K115V1	Century	√	\$904	S1	15.0/7.7-7.75	42	14.4	1, 18
2	1800	115/208-230	145TC	None	K107	Century	√	\$1,141	S1	17.8/9.6-8.9	46	15.2	1, 17

GENERAL PURPOSE, SINGLE PHASE MOTORS

TOTALLY ENCLOSED MOTORS

FEATURES:

- Ball bearings mechanically locked on shaft end (excludes 5K models)
- Heavy gauge steel constructions
- Suitable for horizontal or vertical mounting
- Economical split phase or capacitor start designs, as noted
- Will accept brake kits, see accessory section (except as noted)
- Service factor, as noted
- UL recognized and CSA certified



C-FACE FOOTED (RIGID BASE)

HP	RPM	VOLTS	FRAME	OVER LOAD	CAT. NO.	MODEL NO.	STOCK	LIST PRICE	MULT. SYMB.	F.L. AMPS	WT.	"C" DIM.	FOOT NOTES
1/4	1200	115/230	56C	NONE	C1423	5KCR49MN6063	✓	\$567	F2	6.2/3.1	10	11.4	24
1/3	1800	100-120/200-240	56C	AUTO	E257	5KCR46JN0087X	✓	\$692	F1	4.0-3.8/2.0-1.9	23	11.84	ES, 1, 20, 24
	1800	100-120/200-240	56C	MANUAL	E255	5KCR46JN0087Y	✓	\$696	F1	4.0-3.8/2.0-1.9	26	11.84	ES, 1, 20, 24
	1800	115/208-230	56C	MANUAL	F131	56C17F5358	✓	\$553	F1	6.6/3.1-3.3	23	11.82	2, 18
	1800	115/230	56C	NONE	C1405	5KC35MN145	✓	\$430	F1	6.0/3.0	17	10.93	2, 24, 18
1/2	3600	115/208-230	56C	NONE	C1420	5KC36LN144	✓	\$363	F1	7.4/3.7	17	11.36	2, 24, 19
	3600	115/230	56C	AUTO	C444	5KC36LN144X	✓	\$375	F2	7.4/3.7	25	11.36	24
	1800	100-120/200-240	56C	MANUAL	E264	5KCR46MN0055Y	✓	\$771	F1	5.8-5.6/2.9-2.8	29	11.84	ES, 1, 19, 24
	1800	100-120/200-240	56C	AUTO	E266	5KCR46MN0055X	✓	\$752	F1	5.8-5.6/2.9-2.8	29	11.84	ES, 1, 19, 24
	1800	115/208-230	56C	MANUAL	F132	056C17F5912	✓	\$618	F1	8.8/4.2-4.4	25	11.82	2, 18
	1800	115/230	56C	NONE	C375	5KC42GN0066	✓	\$496	F1	8.6/4.3	23	11.01	2, 18, 24
3/4	1800	100-120/200-240	56C	MANUAL	EG273	5KCR49PN0099Y	✓	\$861	F1	9.0-8.8/4.5-4.4	31	12.44	ES, 1, 19, 24
	1800	100-120/200-240	56C	AUTO	E275	5KCR49PN0099X	✓	\$845	F1	9.0-8.8/4.5-4.4	31	12.44	ES, 1, 19, 24
	1800	115/208-230	56C	MANUAL	F133	056C17F5913	✓	\$719	F1	11/5.4-5.5	29	12.32	2, 18, 24
	1800	115/230	56C	NONE	C1425	5KCR49PN0283	✓	\$596	F1	11.0/5.5	31	12.40	2, 17
	1200	115/230	56C	NONE	C1412	5KCR49WN6078	✓	\$964	F2	12.6/6.3	44	13.81	ES, 1
1	3600	115/230	56C	AUTO	C445	5KC49NN2132X	✓	\$512	F2	13.0/6.5	29	12.44	24
	1800	100-120/200-240	56C	MANUAL	EG282	5KCR49UN0106Y	✓	\$980	F1	11.8-11.4/5.9-5.7	40	12.97	ES, 1, 18
	1800	100-120/200-240	56C	AUTO	EG284	5KCR49UN0106X	✓	\$972	F1	11.8-11.4/5.9-5.7	40	12.97	ES, 1, 18
	1800	115/208-230	56C	NONE	C376	5KC49TN0067	✓	\$638	F1	13.2/6.7-6.6	38	12.97	2, 17
	1800	115/208-230	56C	MANUAL	F134	056C17F5914	✓	\$773	F1	13.4/6.8-6.7	31	12.82	2, 18
	1 1/2	3600	115/208-230	56HCZ	NONE	K631	056B34F5324	✓	\$633	F1	14.2/7.7-7.1	34	12.82
1800		115/208-230	56C	MANUAL	F135	056B17F5584	✓	\$929	F1	15.2/8.2-7.6	41	13.82	1, 5, 18
1800		115/208-230	145TC	NONE	C281	145TBFR5337	✓	\$904	S1	15.2/8.2-7.6	43	13.87	1, 18
2	3600	115/208-230	145TC	NONE	C282	145TBFR5305	✓	\$1,007	S1	16.6/9.1-8.3	42	13.37	1, 18
	1800	115/230	56HC	MANUAL	K319	056B17F5319	✓	\$953	F1	18.8/9.4	50	14.82	1, 5, 18
3	3600	208-230	145TC	NONE	C284	145TBFR5306	✓	\$1,081	S1	13.1-11.8	52	14.87	1, 18
	1800	230	184TC	MANUAL	I314A	184TBFW7041	✓	\$1,428	S1	12.8	86	14.96	1, 13, 18
5	1800	230	184TC	MANUAL	I315A	184TBFW7034	✓	\$1,704	S1	19.5	101	17.47	1, 13, 17

GENERAL PURPOSE, SINGLE PHASE MOTORS

TOTALLY ENCLOSED MOTORS

FEATURES:

- Heavy gauge steel frame and base
- Ball bearings
- Capacitor start / Induction run designs
- Capacitor start / Capacitor run designs as noted
- Service factor as noted
- TENV as noted



C-FACE FOOTED (RIGID BASE)

HP	RPM	VOLTS	FRAME	OVER LOAD	CAT. NO.	MODEL NO.	STOCK	LIST PRICE	MULT. SYMB.	F.L. AMPS	WT.	"C" DIM.	FOOT NOTES
1/3	3450	115/208-230	56C	None	B420	Century®	√	\$442	F1	4.8/2.5-2.4	24	10.2	N, 18
2	3450	115/208-230	56HC	Manual	B861	Century	√	\$1,067	F1	16.6/9.1-8.4	43	14.2	1, 18
	1725	115/230	56HC	Manual	C213	Century	√	\$1,267	F1	17.0/8.5	47	14.4	1, 18

RESILIENT BASE

HP	RPM	VOLTS	FRAME	OVER LOAD	CAT. NO.	MODEL NO.	STOCK	LIST PRICE	MULT. SYMB.	F.L. AMPS	WT.	"C" DIM.	FOOT NOTES
1/4	3450	115/230	56	Auto	B417	Century	√	\$490	F1	4.8/2.4	24	11.2	17
	3450	115/230	48	Auto	B183	Century	√	\$404	F1	6.0/3.0	19	11.6	17
	1140	115/230	56	Auto	C061	Century	√	\$507	F1	4.6/2.3	26	11.5	17
1/3	3450	115/230	56	Auto	B418	Century	√	\$490	F1	5.2/2.6	24	11.2	17
	1140	115/230	56	Auto	C062	Century	√	\$649	F1	5.8/2.9	31	12.6	17
1/2	1140	115/230	56	Auto	C344	Century	√	\$918	F1	8.4/4.2	35	12.9	17
1	1140	115/230	56	Auto	B699	Century	√	\$773	F1	13.6/6.8	49	14.1	1, 17

GENERAL PURPOSE, SINGLE PHASE MOTORS

TOTALLY ENCLOSED, 4-IN-1® MOTORS

FEATURES:

- Double sealed ball bearings, mechanically locked on shaft end
- Heavy gauge steel constructions
- Bolt-on, removable rigid base
- Suitable for horizontal or vertical mounting
- Capacitor start design for high starting torque
- Capacitor start/capacitor run design for higher efficiency, as noted
- 1.15 Service factor (except as noted)
- Will accept brake kits, see accessory section
- Will accept drip cover kits, see accessories section
- UL recognized and CSA certified



C-FACE FOOTED (REMOVABLE BASE)

HP	RPM	VOLTS	4-IN-1® MOTORS	FRAME	OVER LOAD	CAT. NO.	MODEL NO.	STOCK	LIST PRICE	MULT. SYMB.	F.L. AMPS	WT.	"C" DIM.	FOOT NOTES
1/4	1200	115/208-230	YES	56C	NONE	G577	056C11F5302	✓	\$567	F2	6.8/3.1-3.4	24	11.82	
1/3	1800	115/208-230	YES	56C	NONE	G570	056C17F5320	✓	\$441	F2	6.6/3.1-3.3	23	11.82	
	1200	115/208-230	YES	56C	NONE	G576	056C11F5303	✓	\$633	F2	7.8/3.6-3.9	27	12.32	
1/2	3600	115/208-230	YES	56C	NONE	D311	056C34F5301	✓	\$375	F2	8.4/4.0-4.2	22	11.82	
	1800	115/208-230	YES	56C	NONE	G571	056C17F5321	✓	\$505	F2	8.8/4.2-4.4	24	11.82	
	1200	115/208-230	YES	56C	NONE	G578	056B11F5303	✓	\$771	F2	9.6/4.7-4.8	35	13.32	1
3/4	3600	115/208-230	YES	56C	NONE	D312	056C34F5302	✓	\$453	F2	10.6/5.3-5.3	27	12.32	
	1800	115/208-230	YES	56C	NONE	G572	056C17F5322	✓	\$609	F2	11.0/5.4-5.5	30	12.32	
	1200	115/208-230	YES	56C	NONE	G579	056B11F5302	✓	\$964	F2	11.4/5.8-5.7	39	13.82	1
1	3600	115/208-230	YES	56C	NONE	D313	056C34F5303	✓	\$512	F2	11.2/5.7-5.6	30	12.32	
	1800	115/208-230	YES	56HC	NONE	G573	056C17F5323	✓	\$647	F2	13.4/6.8-6.7	31	12.82	5
1 1/2	3600	115/208-230	YES	56C	NONE	D314	056B34F5326	✓	\$644	F2	14.2/7.7-7.1	32	12.82	1
	1800	115/208-230	YES	56HC	NONE	G574	056B17F5305	✓	\$743	F2	15.2/8.2-7.6	40	13.82	1, 5
2	3600	115/208-230	YES	56HC	NONE	D315	056B34F5327	✓	\$775	F2	16.6/9.1-8.3	37	13.82	1, 5
	1800	115/208-230	YES	56HC	NONE	G575	056B17F5306	✓	\$931	F2	20.0/10.8-10.0	51	14.82	1, 5, 17
3	3600	208-230	YES	56HC	NONE	D316	056B34F5328	✓	\$1,036	F2	13.1-11.8	50	14.82	1, 5

C-FACE FOOTED (REMOVABLE BASE)

50 HERTZ

HP	RPM	VOLTS	4-IN-1® MOTORS	FRAME	OVER LOAD	CAT. NO.	MODEL NO.	STOCK	LIST PRICE	MULT. SYMB.	F.L. AMPS	WT.	"C" DIM.	FOOT NOTES
1/2	3000	220-240	YES	56C	NONE	D1312	-		\$521	F2	5.6-5.4	27	12.32	
	1500	220-240	YES	56C	NONE	G1572	-		\$700	F2	5.7-5.5	30	12.32	
3/4	3000	220-240	YES	56C	NONE	D1313	-		\$588	F2	5.8-5.6	30	12.32	
	1500	220-240	YES	56HC	NONE	G1573	-		\$744	F2	6.9-6.7	31	12.82	5
1 1/2	3000	220-240	YES	56C	NONE	D1314	-		\$741	F2	7.3-7.1	32	12.82	1
	1500	220-240	YES	56HC	NONE	G1574	-		\$854	F2	7.8-7.6	40	13.82	1, 5
1	3000	220-240	YES	56HC	NONE	D1315	-		\$891	F2	8.5-8.3	37	13.82	1, 5
	1500	220-240	YES	56HC	NONE	G1575	-		\$1,071	F2	10.4-10.0	51	14.82	1, 5, 17
2	3000	220-240	YES	56HC	NONE	D1316	-		\$1,192	F2	12.1-11.8	50	14.82	1, 5
	1500	220-240	YES	56HC	NONE	G1576	-		\$1,430	F2	13.1-13.5	68	14.82	1, 5

HAZARDOUS DUTY® DIVISION 1 EXPLOSION PROOF MOTORS

CLASS I AND II, GROUPS C, E (AS NOTED), D, F & G
STEEL FRAME, SINGLE PHASE MOTORS

FEATURES:

- 1.0 service factor
- Automatic reset thermal protector
- Meets temperature code T3B
- Economical split phase or capacitor start designs, as noted
- Explosion proof conduit box included, shipped loose
- UL listed file no. E12044
- CSA certified file no. LR47504



RESILENT BASE

HP	RPM	VOLTS	FRAME	GROUP C	GROUP E	CAT. NO.	MODEL NO.	STOCK	LIST PRICE	MULT. SYMB.	F.L. AMPS	WT.	"C" DIM.	FOOT NOTES
1/4	1800	115/230	56	N	N	K032	056C17E5302		\$596	F1	4.8/2.4	26	11.88	2, N, 37
	1200	115	56	N	N	K033	056C11G5303	✓	\$819	F1	5.4	31	14.46	2, 37
1/3	1800	115	56	N	N	K037	056C17G5308		\$779	F1	6.6	29	13.96	2, 37

RIGID BASE

HP	RPM	VOLTS	FRAME	GROUP C	GROUP E	CAT. NO.	MODEL NO.	STOCK	LIST PRICE	MULT. SYMB.	F.L. AMPS	WT.	"C" DIM.	FOOT NOTES
1/12	1800	115	48	N	N	H454	5KH32ENB168	✓	\$719	F1	1.9	17	9.68	3, N
1/8	1200	115	48	N	N	HG455	5KH36NNB166	✓	\$814	F1	3.0	23	10.74	3, N
1/6	1800	115	48	N	N	HG456	5KH35LNB164	✓	\$746	F1	3.3	21	10.31	3, N
	1200	115	56	Y	N	H891	5KC49LN6386	✓	\$953	F1	3.8	29	12.47	2, N
1/4	1800	115	48	N	N	HG458	5KH36PNB171	✓	\$771	F1	4.4	24	10.74	3, N
	1800	115/208-230	56	Y	N	G639	56C17E5314	✓	\$711	F1	4.8/2.3-2.4	26	11.97	2, N
	1800	115/208-230	56	Y	Y	G639A	56C17E15513	✓	\$735	F1	4.8/2.3-2.4	25	11.97	2, N
	1800	115/230	48	N	N	C646	5KC36PNB169	✓	\$873	F1	4.2/2.1	24	10.74	2, N
	1200	115	56	Y	N	C1801	5KC49MN6384	✓	\$1,136	F1	5.6	31	13.94	2
1/3	1200	115/208-230	56	Y	N	G650	56C11G5306	✓	\$951	F1	6.8/3.1-3.4	28	13.94	2
	1800	115/208-230	56	Y	N	G651	56C17G5315	✓	\$811	F1	6.6/3.1-3.3	27	13.44	2
	1800	115/208-230	56	Y	Y	G651A	56C17G15555	✓	\$854	F1	6.6/3.1-3.3	27	13.44	2
	1500	110/220-230	56	Y	N	C1803	5KC49HN0719	✓	\$961	F1	5.0/2.5-2.5	28	13.44	2, 50
1/2	1200	115/208-230	56	Y	N	G652	56C11G5307	✓	\$1,022	F1	7.8/3.6-3.9	31	13.94	2
	3600	115/208-230	56	Y	N	G653	56C34G5308	✓	\$730	F1	8.4/4.0-4.2	26	13.44	2
	1800	115/208-230	56	Y	N	G654	56C17G5316	✓	\$886	F1	8.8/4.2-4.4	30	13.94	2
	1800	115/208-230	56	Y	Y	G654A	56C17G15556	✓	\$918	F1	8.8/4.2-4.4	29	13.94	2
	1500	110/220	56	Y	N	C1807	5KC49QN0716	✓	\$985	F1	7.8/3.9	33	14.44	2, 50
	1200	115/208-230	56	Y	N	C1809	5KC49SN6375		\$1,178	F1	9.6/4.7-4.8	39	14.94	2
3/4	1200	115/208-230	56	Y	N	G655	56B11G5301	✓	\$1,178	F1	9.6/4.7-4.8	39	14.94	1
	3600	115/208-230	56	Y	N	G656	56C34G5309		\$822	F1	10.6/5.3-5.3	31	13.94	2
	1800	115/208-230	56	Y	N	G657	56C17G5317	✓	\$995	F1	11.0/5.4-5.5	33	14.44	2
1	1800	115/208-230	56	Y	Y	G657A	56C17G15557	✓	\$1,073	F1	11.0/5.4-5.5	33	14.44	2
	3600	115/208-230	56	Y	N	G658	56C34G5310		\$888	F1	12.4/6.7-6.2	40	14.44	2
	1800	115/208-230	56	Y	N	G659	56C17G5318	✓	\$1,039	F1	13.4/6.8-6.7	34	14.44	2
1 1/2	1800	115/208-230	56H	Y	Y	G659A	56C17G15558	✓	\$1,143	F1	13.4/6.8-6.7	36	14.08	2, 5
	1800	208-230	56H	Y	Y	G691	56B17G15522	✓	\$1,213	F1	8.1-7.8	53	16.08	1, 5

SINGLE PHASE

HAZARDOUS DUTY® DIVISION 1 EXPLOSION PROOF MOTORS

CLASS I AND II, GROUPS C, D, F & G
STEEL FRAME, SINGLE PHASE MOTORS

FEATURES:

- 1.0 service factor
- Automatic reset thermal protector
- Meets temperature code T3B
- 56CZ frame motors have 2-1/4 x 5/8 shaft dimensions
- Capacitor start design for high starting torque
- Explosion proof conduit box included, shipped loose
- UL listed file no. E12044
- CSA certified file no. LR47504



C-FACE FOOTLESS

HP	RPM	VOLTS	FRAME	CAT. NO.	MODEL NO.	STOCK	LIST PRICE	MULT. SYMB.	FL. AMPS	WT.	"C" DIM.	FOOT NOTES
1/4	1800	115/208-230	56C	G852	056C17E5319	√	\$738	F1	4.8/2.3-2.4	25	11.97	N
	1200	115	56CZ	C1818	5KC49MN6379	√	\$1,063	F1	5.6	31	14.30	
1/3	1800	115/208-230	56C	G853	056C17G5320	√	\$832	F1	6.6/3.1-3.3	27	13.44	
1/2	3600	115/208-230	56C	G854	056C34G5311	√	\$749	F1	8.4/4.0-4.2	26	13.44	
	3600	115/208-230	56J	C1814	5KC49HN2509	√	\$1,100	F1	8.4/4.0-4.2	26	13.95	
	1800	115/208-230	56C	G855	056C17G5321	√	\$905	F1	8.8/4.2-4.4	28	13.94	
	1200	115	56CZ	C1817	5KC49SN6380	√	\$1,355	F1	8.0	40	15.30	
3/4	1800	115/208-230	56C	G857	056C17G5322	√	\$1,014	F1	11.0/5.4-5.5	33	14.44	
1	3600	115/208-230	56C	G858	056C34G5316		\$908	F1	12.4/6.7-6.2	34	14.44	
	1800	115/208-230	56C	G870	056C17G5323	√	\$1,058	F1	13.4/6.8-6.7	34	14.44	

C-FACE FOOTED (RIGID BASE)

HP	RPM	VOLTS	FRAME	CAT. NO.	MODEL NO.	STOCK	LIST PRICE	MULT. SYMB.	FL. AMPS	WT.	"C" DIM.	FOOT NOTES
1/3	1800	115/208-230	56C	G871	056C17G5324	√	\$798	F1	6.6/3.1-3.3	30	13.44	
1/2	1800	115/208-230	56C	G872	056C17G5328	√	\$913	F1	8.8/4.2-4.4	29	13.94	
3/4	3600	115/208-230	56C	G873	056C34G5314	√	\$849	F1	10.6/5.3-5.3	30	13.94	
	1800	115/208-230	56C	G874	056C17G5326	√	\$1,022	F1	11.0/5.4-5.5	34	14.44	
1	3600	115/208-230	56C	G875	056C34G5315		\$918	F1	12.4/6.0-6.2	34	14.44	
	1800	115/208-230	56C	G876	056C17G5327	√	\$1,084	F1	13.4/6.8-6.7	35	14.44	

SINGLE PHASE

XRI® GENERAL PURPOSE, THREE PHASE MOTORS

DRIPPROOF MOTORS

FEATURES:

- Meets or exceeds all USA mandated efficiencies
- Motors are suitable for 10:1 VT on all frame sizes and 10:1 CT up to 365T frame
- 1.15 Service factor on sinewave (except as noted)
1.0 Service factor on IGBT power
- Bearing Current Protection (BCP), as noted
- Class F insulation, as noted
- Nameplated 60/50 hertz, as noted
- Thermal Protection, as noted
- Will accept C-face kits, see accessory section, as noted
- UL recognized, CSA certified and CE mark
- Two year warranty on non bold blue catalog numbers
- Three year warranty on bold blue catalog numbers

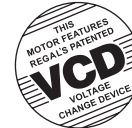

As Noted



RIGID BASE

HP	RPM	VOLTS	FRAME	OVER LOAD	CAT. NO.	MODEL NO.	STOCK	LIST PRICE	MULT. SYMB.	NOM. EFF.	F.L. AMPS	WT.	"C" DIM.	FOOT NOTES	C-FACE KITS
1/4	1800	230/460	48	NONE	G044A	048T17D11009	√	\$343	F1	69.5	1.0/0.5	18	10.34	13, 20, 68	N/A
1/3	3600	230/460	48	NONE	K113A	048T34D11001	√	\$357	F1	69.5	1.4/0.7	17	10.45	20, 68	N/A
	1800	230/460	48	NONE	K527A	048T17D11010	√	\$416	F1	73.4	1.2/0.6	20	10.84	13, 20, 68	N/A
	1800	208	56	NONE	G046A	056T17D11051	√	\$416	F1	73.4	1.35	20	11.22	13, 20	N/A
	1800	230/460	56	NONE	G047A	056T17D11049	√	\$416	F1	73.4	1.2/0.6	20	11.22	13, 20, 68	N/A
	1200	230/460	56	NONE	G061A	056T11D11005	√	\$516	F1	71.4	1.4/0.7	19	11.97	13, 20, 68	N/A
1/2	3600	230/460	56	NONE	K027A	056T34D15595	√	\$395	F1	73.3	1.8/0.9	28	12.70	19, 68	N/A
	3600	230/460	48	NONE	K115A	048T34D11002	√	\$395	F1	77.0	1.8/0.9	17	10.45	19, 68	N/A
	1800	208	56	NONE	G062A	056T17D11044	√	\$488	F1	78.2	1.9	29	11.32	19	N/A
	1800	208-230/460	56	AUTO	G905A	056T17DRR70021A1	√	\$579	F1	78.2	1.7-1.8/0.9	25	11.99	13, 19, 6, 8, VC	N/A
	1800	230/460	56	NONE	G063A	056T17D15908	√	\$488	F1	78.2	1.7/0.85	28	11.32	19, 68	N/A
	1800	575	56	NONE	G065	056T17D2112	√	\$406	F1	70.0	0.9	17	10.47	d, 19	N/A
	1800	575	56	NONE	G065A	056T17D11043	√	\$488	F1	78.2	0.7	31	11.32	19	N/A
	1500	220/380	56	NONE	K318	5K42JN4163	√	\$561	F1	66.7	3.0/1.7	23	10.05	19, 50	A534
	1200	230/460	56	NONE	G067A	056T11D15522	√	\$653	F1	75.3	2.8/1.4	28	12.08	19, 68	N/A
	900	230/460	143T	NONE	H180	143TTDR5401	√	\$663	E6	64.0	3.0/1.5	32	11.49	5, 13	A436
3/4	3600	230/460	56	NONE	G080A	056T34D15593	√	\$387	F1	76.8	2.2/1.1	19	11.70	19, 68	N/A
	1800	208	56	NONE	G082A	056T17D11041	√	\$545	F1	81.1	2.9	31	11.32	19	N/A
	1800	230/460	56	NONE	G084A	056T17D11055	√	\$545	F1	81.1	2.6/1.3	32	11.32	19, 68	N/A
	1800	208-230/460	56	AUTO	G908A	056T17DRR70023A1	√	\$607	F1	81.1	2.6-2.6/1.3	29	12.49	13, 19, 68	A435
	1800	575	56	NONE	G086	056T17D2110	√	\$454	F1	75.5	1.1	20	10.97	d, 19	N/A
	1800	575	56	NONE	G086A	056T17D11040	√	\$545	F1	81.1	2.9	31	11.32	19	N/A
	1200	230/460	56H	NONE	G088A	056T11D15525	√	\$676	F1	81.7	3.2/1.6	43	14.41	68	N/A
	1200	230/460	143T	NONE	H150	143TTDR5376	√	\$512	E6	74.0	3.2/1.6	29	10.99	5, 13, 68	A436
	900	230/460	145T	NONE	H181	145TTDR5401	√	\$752	E6	72.0	4.0/2.0	42	12.99	5, 13, 68	A436
1	3600	230/460	56	NONE	K000A	056T34D15600	√	\$647	F1	77.0	3.0/1.5	19	11.43	13, 19, 68	N/A
	3600	208-230/460	56	TSTATS	U244	056T34D6001	√	\$647	F1	78.5	3.0-2.8/1.4	25	10.44	13, 68	A435
	1800	208	56	NONE	K003A	056T17D11047	√	\$561	F1	83.5	3.3	34	11.72		N/A
	1800	208-230/460	56	NONE	K122	5K46MN4072	√	\$478	F1	79.2	3.6-3.8/1.9	27	10.78	d, 19	A534
	1800	208-230/460	56	NONE	K004	056T17D2092	√	\$467	F1	77.0	3.5-3.2/1.6	23	11.32	d, 13, 68	N/A
	1800	230/460	56	NONE	K004A	056T17D15915	√	\$561	F1	83.5	3.0/1.5	34	11.69	68	N/A
	1800	208-230/460	56	AUTO	G921A	056T17DRR70010A1	√	\$647	F1	83.5	3.2-3.0/1.5	42	13.99	VC, 13, 68	N/A
	1800	208-230/460	56HZ	AUTO	K063	056T17D3301	√	\$598	F1	77.0	3.5-3.6/1.8	27	10.99	Z, 5, 13, 68	A436
	1800	208-230/460	56HZ	AUTO	K067	056T17D3305	√	\$620	F1	77.0	3.4-3.6/1.8	30	10.99	VC, Z, 13, 68	A436
	1800	575	56	NONE	K049	056T17D2130	√	\$467	F1	76.5	1.4	24	11.47	d	N/A
	1800	575	56	NONE	K049A	056T17D11046	√	\$561	F1	83.5	1.2	35	11.72		N/A
	1800	575	56HZ	AUTO	K081	056T17D15528	√	\$598	F1	77.0	1.45	27	10.99	5, 13, Z	A436
	1800	200	143T	NONE	E901A	143TTDR16056	√	\$738	E2	85.5	3.45	42	13.99	5, 13	N/A
	1800	200-208	143T	AUTO	U416A	143TTDR16035	√	\$789	E2	85.5	3.3/3.3	44	12.99	5, 13	A436
	1800	230/460	143T	NONE	E927A	143TTDR16055	√	\$738	E2	85.5	3.45	42	12.99	5, 13, 68	A436
1800	208-230/460	143T	AUTO	U417A	143TTDR6052	√	\$789	E2	85.5	3.2-3.0/1.5	45	12.99	5, 13, 68	A436	
1800	208-230/460	143T	AUTO	U418A	143TTDR6051	√	\$789	E2	85.5	3.2-3.0/1.5	45	12.99	5, 13, 68	A436	

Catalog numbers (Cat No.) highlighted in bold blue have efficiency levels that meet the USA efficiency legislations.

Continued on next page.

XRI® GENERAL PURPOSE, THREE PHASE MOTORS

DRIPPROOF MOTORS

HP	RPM	VOLTS	FRAME	OVER LOAD	CAT. NO.	MODEL NO.	STOCK	LIST PRICE	MULT. SYMB.	NOM. EFF.	FL. AMPS	WT.	"C" DIM.	FOOT NOTES	C-FACE KITS	
1	1800	208-230/460	143T	TSTAT	U758	143TTDR6027	✓	\$738	E2	85.5	3.5-3.2/1.6	30	12.12	13, 68	A600	
	1800	208-230/460	143T	NONE	U758-P	143TTDR16052	✓	\$838	E2	85.5	3.5-3.2/1.6	30	12.50	13, 68, P	A436	
	1800	575	143T	NONE	E912A	143TTDR16037	✓	\$738	E2	85.5	1.3	30	12.99	13	A436	
	1800	575	143T	AUTO	U922A	143TTDR16036	✓	\$789	E2	85.5	1.2	45	12.99	5, 13	A436	
	1200	230/460	56H	NONE	K007A	056T11D15526	✓	\$730	F1	82.5	1.0/2.0	28	14.91	5, 68	N/A	
	1200	200	145T	NONE	E785A	145TTDR16089	✓	\$799	E2	82.5	4.4	46	13.49	13	A436	
	1200	230/460	145T	TSTAT	U265	145TTDR6076	✓	\$799	E2	82.5	3.8/1.9	41	12.62	13, 68	A600	
	1200	575	145T	NONE	E934A	145TTDR16077	✓	\$799	E2	82.5	1.5	46	13.49	13	A436	
	900	230/460	182T	NONE	H182A	182TTDW7101	✓	\$814	E2	75.8	4.0/2.0	69	12.19	13	A666	
1 1/2	3600	230/460	56	NONE	K009A	056T34D15599	✓	\$542	F1	84.0	4.2/2.1	64	12.70	68	N/A	
	3600	200	143T	NONE	E917A	143TTDR16024	✓	\$720	E2	84.0	4.4	64	12.49	5, 13, 68	A436	
	3600	230/460	143T	NONE	E783A	143TTDR6313	✓	\$720	E2	84.0	3.8/1.9	64	12.49	5, 13, 68	A436	
	3600	208-230/460	143T	TSTAT	U245	143TTDR6028	✓	\$720	E2	84.0	4.4-4.0/2.0	64	12.28	5, 13, 68	A600	
	3600	575	143T	NONE	E798A	143TTDR16005	✓	\$720	E2	84.0	1.6	64	12.28	5, 13	A436	
	1800	230/460	56H	NONE	K022A	056T17D15911	✓	\$622	F1	86.5	4.6/2.3	44	14.07	5, 68	N/A	
	1800	208-230/460	56H	AUTO	G923A	056T17DRR70011A1	✓	\$738	F1	86.5	4.4-4.4/2.2	40	13.99	5, 13, 68, VC	A436	
	1800	208-230/460	56HZ	AUTO	K064	056T17D3302	✓	\$634	F1	80.0	4.8-4.8/2.4	30	10.99	5, 13, 68, Z	A436	
	1800	208-230/460	56HZ	AUTO	K068	056T17D3306	✓	\$650	F1	80.0	4.8-4.8/2.4	33	10.99	5, 13, 68, Z, VC	A436	
	1800	575	56H	NONE	K061	056T17D5369	✓	\$518	F1	80.0	1.9	27	10.94	d, 5	A436	
	1800	575	56H	NONE	K061A	056T17D15913	✓	\$622	F1	86.5	1.9	44	14.07		N/A	
	1800	200	145T	NONE	E902A	145TTDR16355	✓	\$770	E2	86.5	5.1	46	13.99	5, 13	A436	
	1800	200-208	145T	AUTO	U419A	145TTDR16441	✓	\$838	E2	86.5	4.9-4.8	42	14.07	5, 13	N/A	
	1800	230/460	145T	NONE	E928A	145TTDR16351	✓	\$770	E2	86.5	4.4/2.2	52	12.99	5, 13, 68	A436	
	1800	208-230/460	145T	AUTO	U420A	145TTDR6126	✓	\$838	E2	86.5	4.4-4.4/2.2	48	12.49	5, 13, 68	A436	
	1800	208-230/460	145T	AUTO	U421A	145TTDR6127	✓	\$870	E2	86.5	4.4-4.4/2.2	48	12.49	5, 13, 68, VC	A436	
	1800	208-230/460	145T	TSTAT	U759	145TTDR6028	✓	\$770	E2	86.5	4.8-5.6/2.4	35	12.62	13, 68	A600	
	1800	208-230/460	145T	NONE	U759-P	145TTDR16348	✓	\$881	E2	86.5	4.8-5.6/2.4	35	13.00	13, 68, P	A436	
	1800	575	145T	NONE	E913A	145TTDR16061	✓	\$770	E2	86.5	1.8	35	12.62	13	A600	
	1800	575	145T	AUTO	U923A	145TTDR16054	✓	\$838	E2	86.5	1.8	47	12.99	5, 13	A436	
	1500	220/380	145T	NONE	K408	5K49SN8050	✓	\$727	E2	81.7	4.5/2.6	35	13.59	50	A536	
	1200	200	182T	NONE	E1799	182TTDW4083	✓	\$682	E2	84.0	7.2	75	12.69	d, 13	A666	
	1200	200	182T	NONE	E799B	182TTDW16090	✓	\$940	E2	86.5	6.1	70	13.19	13	A666	
	1200	208-230/460	182T	TSTAT	U1266	182TTDW6076	✓	\$940	E2	86.5	6.2/3.1	68	13.19	13, 68	A666	
	1200	575	182T	NONE	U914	182TTDW16009	✓	\$940	E2	86.5	2.5	68	13.19	13	A666	
	900	230/460	184T	NONE	H183A	184TTDW7101	✓	\$988	E2	77.0	5.6/2.8	62	13.19	13	A666	
	2	3600	230/460	56H	NONE	K025A	056T34D15598	✓	\$639	F1	85.5	5.4/2.7	37	13.44	68, B	N/A
		3600	200	145T	NONE	U905A	—	✓	\$849	E2	85.5	5.9	43	13.12	5, 13	A436
		3600	208-230/460	145T	TSTAT	U246	145TTDR6039	✓	\$849	E2	85.5	5.2-4.8/2.4	43	13.12	5, 13, 68	A436
		3600	575	145T	NONE	U906A	145TTDR16008	✓	\$849	E2	85.5	2.1	43	13.12	5, 13	A436
1800		208-230/460	56H	NONE	K041	056T17D5310	✓	\$569	F1	81.5	6.2-6.2/3.1	33	11.94	d, 5, 68	A436	
1800		230/460	56H	NONE	K041A	056T17D15715	✓	\$655	F1	86.5	6.0/3.0	47	13.44	5, 13, 68, B	A436	
1800		208-230/460	56HZ	AUTO	K065	056T17D3303	✓	\$681	F1	81.5	6.2-6.2/3.1	35	11.99	5, 13, 68, B, Z	A436	
1800		208-230/460	56HZ	AUTO	K069	056T17D3307	✓	\$701	F1	81.5	6.2-6.2/3.1	34	11.99	5, 13, 68, B, Z, VC	A436	
1800		575	56H	NONE	K062	056T17D5370	✓	\$569	F1	81.5	2.5	33	11.94	d, 5	A436	
1800		575	56H	NONE	K062A	056T17D15716	✓	\$655	F1	86.5	2.4	47	13.44	B	N/A	
1800		208	145T	NONE	E903A	145TTDR16356	✓	\$830	E2	86.5	6.6	56	14.49	B	N/A	
1800		200-208	145T	AUTO	U422	145TTDR4134	✓	\$773	E2	84.0	6.7-6.6	43	12.99	d, 5, 13, B	A436	
1800		200-208	145T	AUTO	U422A	145TTDR16056	✓	\$872	E2	86.5	6.6-6.6	58	14.49	5, 13	A436	
1800		230/460	145T	NONE	E929A	145TTDR16352	✓	\$830	E2	86.5	6.0/3.0	46	13.49	5, 13, 68	A436	
1800		208-230/460	145T	AUTO	U423A	145TTDR6132	✓	\$872	E2	86.5	6.2-6.0/3.0	56	12.49	5, 13, 68	A436	
1800		208-230/460	145T	AUTO	U424A	145TTDR6133	✓	\$905	E2	86.5	6.2-6.0/3.0	56	12.99	5, 13, 68, B, VC	A436	
1800		208-230/460	145T	TSTAT	U760	145TTDR6029	✓	\$830	E2	86.5	6.4-5.8/2.9	37	13.62	13, 68	A600	
1800		208-230/460	145T	NONE	U760-P	145TTDR16349	✓	\$920	E2	86.5	6.4-5.8/2.9	37	14.00	5, 13, 68, P	A436	
1800		575	145T	NONE	E914A	145TTDR16062	✓	\$830	E2	86.5	2.4	37	13.62	5, 13	A600	
1800		575	145T	AUTO	U924A	145TTDR16059	✓	\$872	E2	86.5	2.4	56	13.49	5, 13	A436	
1200		200	184T	NONE	E918A	184TTDW16083	✓	\$1,030	E2	88.5	8.3	90	15.19	13	N/A	
1200		208-230/460	184T	TSTAT	U1267	184TTDW6076	✓	\$1,030	E2	87.5	7.2/3.6	90	15.19	13, 68	A666	
1200		575	184T	NONE	U915	184TTDW16076	✓	\$1,030	E2	87.5	2.9	90	15.19	13	A666	
900		230/460	213T	NONE	H184B	213TTDR16101	✓	\$1,509	E2	85.5	8.0/4.0	137	17.30	B	N/A	

Catalog numbers (Cat No.) highlighted in bold blue have efficiency levels that meet the USA efficiency legislations.

Continued on next page.

XRI® GENERAL PURPOSE, THREE PHASE MOTORS

DRIPPROOF MOTORS

HP	RPM	VOLTS	FRAME	OVER LOAD	CAT. NO.	MODEL NO.	STOCK	LIST PRICE	MULT. SYMB.	NOM. EFF.	F.L. AMPS	WT.	"C" DIM.	FOOT NOTES	C-FACE KITS	
3	3600	208-230/460	56H	NONE	K048	056T34D5340		\$676	F1	84.0	8.8-8.2/4.1	32	11.44	5, B	A436	
	3600	230/460	56H	NONE	K048A	056T34D15596		\$709	F1	86.5	7.2/3.6	28	14.32	68, B	N/A	
	3600	200	145T	NONE	E919A	—		\$859	E2	86.5	8.2	45	13.12	5, 13	A600	
	3600	208-230/460	145T	TSTAT	U247	145TTDR6002	√	\$859	E2	86.5	8.0-7.2/3.6	45	13.12	5, 13, 68	A600	
	3600	575	145T	NONE	E932A	145TTDR16010	√	\$859	E2	86.5	2.9	45	13.12	5, 13	A600	
	1800	208-230/460	56HZ	NONE	H803	056T17D5398	√	\$620	F1	84.0	9.2-8.6/4.3	47	13.49	13, 68, B, Z	A436	
	1800	208-230/460	56HZ	AUTO	K066	056T17D3304	√	\$695	F1	84.0	9.2-8.6/4.3	47	13.49	5, 13, 68, B, Z	A436	
	1800	208-230/460	56HZ	AUTO	K080	056T17D3308	√	\$717	F1	84.0	9.2-8.6/4.3	47	13.99	5, 13, 68, B, Z, VC	A436	
	1800	200	182T	NONE	E904B	182TTDW16064	√	\$894	E2	89.5	9.5	70	13.19	13	A666	
	1800	200-208	182T	AUTO	U425B	182TTDW16048		\$1,065	E2	89.5	9.0-8.9	71	13.19	13	A666	
	1800	230/460	182T	NONE	U409B	182TTDW16328		\$894	E2	89.5	8.0/4.0	71	13.19	13, 68	A666	
	1800	230/460	182T	AUTO	U426B	182TTDW16049	√	\$1,065	E2	89.5	8.0/4.0	71	13.19	13, 68	A666	
	1800	208-230/460	182T	TSTAT	E1930	182TTDC6030	√	\$894	E2	89.5	8.4-8.0/4.0	76	14.19	13, 68	A666	
	1800	208-230/460	182T	NONE	E1930-P	182TTDW16063	√	\$984	E2	89.5	8.4-8.0/4.0	76	14.56	13, 68, P	A666	
	1800	575	182T	NONE	E915B	182TTDW16029	√	\$894	E2	89.5	3.4	76	14.19	13, B	A666	
	1800	575	182T	AUTO	U925A	182TTDW16082		\$1,065	E2	89.5	3.2	87	14.19	13, B	A666	
	1200	200	213T	NONE	U907A	213TTDWD16086	√	\$1,250	E2	88.5	10.4	110	17.30		A606	
	1200	208-230/460	213T	NONE	U268	213TTDC6076	√	\$1,412	E2	88.5	10.2-10.0/5.0	156	16.38		A602	
	1200	575	213T	NONE	U279	213TTDC6079	√	\$1,412	E2	88.5	4.0	156	16.38	13	A602	
	900	230/460	215T	NONE	H185B	215TTDR16101		\$2,110	E2	87.5	10.0/5.0	166	21.60	13, B	N/A	
5	3600	200	182T	NONE	E933A	182TTDW16316		\$942	E2	86.5	13.8	64	13.19		A666	
	3600	208-230/460	182T	TSTAT	U1248	182TTDW6001	√	\$942	E2	86.5	13.0-12.0/6.0	86	15.19	13, 68	A666	
	3600	575	182T	NONE	U908A	182TTDW16008	√	\$942	E2	86.5	5.6	86	13.19	13	A666	
	1800	200	184T	NONE	E905B	184TTDW16071	√	\$1,006	E2	89.5	14.5	81	14.19	13	A666	
	1800	200	184T	AUTO	U427B	184TTDW16326	√	\$1,205	E2	89.5	14.5	81	14.19		A666	
	1800	230/460	184T	AUTO	U428B	184TTDW16038	√	\$1,205	E2	89.5	12.6/6.3	80	14.19	13, 68	A666	
	1800	208-230/460	184T	TSTAT	E1931	184TTDW6031	√	\$1,006	E2	89.5	13.6-12.8/6.4	89	14.19	13, 68	A666	
	1800	208-230/460	184T	NONE	E1931-P	184TTDW16061	√	\$1,220	E2	89.5	13.6-12.8/6.4	89	14.56	13, 68, P	A666	
	1800	575	184T	NONE	E916B	184TTDW16040	√	\$1,006	E2	89.5	5.1	80	14.19	13	A666	
	1800	575	184T	AUTO	U917	184TTDW16041		\$1,205	E2	89.5	5.1	81	14.19	13	A666	
	1200	200	215T	NONE	E935	215TTDW4078	√	\$1,379	E2	87.5	16.3	145	18.55	d, 13, B	A606	
	1200	200	215T	NONE	E935A	215TTDWD16087	√	\$1,533	E2	89.5	15.9	162	18.55	13, B	A606	
	1200	208-230/460	215T	NONE	U269	215TTDC6076	√	\$1,643	E2	90.2	15.8-15.0/7.5	185	16.38		A602	
	1200	575	215T	NONE	U280	215TTDC6079	√	\$1,643	E2	90.2	6.0	185	16.38		A602	
	900	230/460	254T	NONE	H186B	254TTDN16101	√	\$2,920	E2	88.5	15.0/7.5	298	22.87		N/A	
	7 1/2	3600	200	184T	NONE	E937B	184TTDW16315		\$1,363	E2	88.5	20.5	72	15.19		A666
		3600	208-230/460	184T	TSTAT	U249A	184TTDW6001	√	\$1,363	E2	88.5	19.6-17.6/8.8	106	16.19	68	A666
		3600	575	184T	NONE	E938A	184TTDW16027	√	\$1,363	E2	88.5	7.0	106	16.19	13	A666
		1800	200	213T	NONE	E906B	213TTDWD16334	√	\$1,220	E2	91.0	23.0	145	17.30	B	A606
		1800	200-208	213T	AUTO	U429A	213TTDWD16349		\$1,518	E2	91.0	22.4-22.1	145	18.04		A606
1800		230/460	213T	NONE	E720B	213TTDWD16330		\$1,220	E2	91.0	20.0/10.0	124	17.30	68	A606	
1800		230/460	213T	AUTO	U430A	213TTDW16060	√	\$1,518	E2	91.0	19.2/9.6	135	19.29	d, 68	A606	
1800		230/460	213T	AUTO	U430B	213TTDWD16060	√	\$1,518	E2	91.0	20.0/10.0	135	19.29	68	A606	
1800		208-230/460	213T	NONE	U430A-P	213TTDW16075	√	\$1,621	E2	91.0	21.0-19.2/9.6	135	19.67	d, 13, 68, P	A606	
1800		230/460	213T	NONE	U430B-P	213TTDWD16075	√	\$1,621	E2	91.0	20.0/10.0	135	19.29	P	A606	
1800		208-230/460	213T	NONE	U763	213TTDC6026	√	\$1,302	E2	91.0	20.6-19.8/9.9	160	16.38		A602	
1800		575	213T	NONE	E758A	213TTDW6030		\$1,220	E2	91.0	7.7	200	18.55		A606	
1800		575	213T	AUTO	U926A	213TTDW16061		\$1,518	E2	91.0	7.7	125	19.29	B	A606	
1800		575	213T	NONE	U281	213TTDC6029	√	\$1,302	E2	91.0	7.8	160	16.38		A602	
1200		230/460	254T	NONE	E733A	254TTDX16082	√	\$2,054	E2	92.4	21.0/10.5	240	22.40	13, 68	N/A	
1200		575	254T	NONE	U282	254TTDC6079	√	\$2,054	E2	92.4	8.1	281	20.94	YD	A622	
900		230/460	256T	NONE	H187B	256TTDN16101	√	\$3,667	E2	89.5	23.0/12.5	300	24.37		N/A	
10		3600	200	213T	NONE	E939A	213TTDWD16314		\$1,485	E2	90.2	27.8	120	17.30		A606
		3600	208-230/460	213T	NONE	U764	213TTDC6001	√	\$1,501	E2	91.0	25.0-23.6/11.8	150	16.38		A602
		3600	575	213T	NONE	U283	213TTDC6003	√	\$1,501	E2	91.0	9.4	150	17.87		A602
	1800	200	215T	NONE	E907A	215TTDWD16346	√	\$1,436	E2	91.7	30.0	120	17.30		A606	
	1800	208-230/460	215T	NONE	U431A-P	215TTDW16073	√	\$1,760	E2	91.7	29.0-26.2/13.1	145	22.15	d, 13, 68, P	A606	
	1800	230/460	215T	NONE	U431B-P	215TTDWD16073	√	\$1,760	E2	91.7	26.2/13.1	145	18.25	68, P	A606	
	1800	208-230/460	215T	NONE	U765	215TTDC6026	√	\$1436	E2	91.7	28.5-25.6/12.8	198	17.87		A602	

Catalog numbers (Cat No.) highlighted in bold blue have efficiency levels that meet the USA efficiency legislations.

Blue shaded areas are cast iron frames.

Continued on next page.

XRI® GENERAL PURPOSE, THREE PHASE MOTORS

DRIPPROOF MOTORS

HP	RPM	VOLTS	FRAME	OVER LOAD	CAT. NO.	MODEL NO.	STOCK	LIST PRICE	MULT. SYMB.	NOM. EFF.	FL. AMPS	WT.	"C" DIM.	FOOT NOTES	C-FACE KITS
10	1800	575	215T	NONE	E759A	215TTDWD16345		\$1,436	E2	91.7	10.5	85	17.30	B	A606
	1800	575	215T	NONE	U284	215TTDC6029	✓	\$1,436	E2	91.7	10.0	195	17.87	A	A602
	1200	230/460	256T	NONE	E734A	256TTDX16078	✓	\$2,350	E2	91.7	27.4/13.7	305	23.90	13, 68	A612
	1200	575	256T	NONE	U285	215TTDC6079	✓	\$2,561	E2	91.7	10.8	305	22.60	YD	A622
	900	1	284T	NONE	H188B	284TTDN16101		\$4,356	E2	90.2	29.0/14.5	430	24.94	68	A287
15	3600	200	215T	NONE	E788A	215TTDWD4003	✓	\$1,928	E2	90.2	42.0	112	18.55	B	A606
	3600	208-230/460	215T	NONE	U766	215TTDC6001	✓	\$2,177	E2	91.0	38.0-34.6/17.3	184	17.87	99	A602
	3600	575	215T	NONE	U286	215TTDC6003	✓	\$2,177	E2	91.0	13.8	184	17.87	99	A602
	1800	200	254T	NONE	E908	254TTDX4028	✓	\$1,936	E2	91.0	44.2	208	22.32	d, B	A612
	1800	200	254T	NONE	E908A	254TTDR16029	✓	\$2,004	E2	93.0	42.5	240	22.10	B	N/A
	1800	230/460	254T	NONE	E722A	254TTDX16042	✓	\$2,004	E2	93.0	38.0/18.9	230	22.10	13, 68	A612
	1800	230/460	254T	NONE	E722A-P	254TTDX16043	✓	\$2,244	E2	93.0	38.0/18.9	230	22.50	68, P	A612
	1800	208-230/460	254T	NONE	U767	254TTDC6026	✓	\$2,128	E2	93.0	40.5-37.0/18.5	310	20.94	A, YD	A622
	1800	575	254T	NONE	E760A	—	✓	\$2,004	E2	93.0	15.0	180	22.10		N/A
	1800	575	254T	NONE	U287	254TTDC6029	✓	\$2,128	E2	93.0	15.0	310	20.94	A, YD	A622
	1200	230/460	284T	NONE	E1002	284TTDR16077	✓	\$3,107	E2	91.7	43.0/21.5	340	24.30	13, 68	A210
	1200	208-230/460	284T	NONE	U256	284TTDC6076	✓	\$3,372	E2	92.4	42.0-39.5/19.7	414	23.54	YD	A626
	1200	575	284T	NONE	U288	284TTDC6079	✓	\$3,372	E2	92.4	16.0	414	23.54	YD	A626
	900	230/460	286T	NONE	H189B	286TTDN16102		\$5,720	E2	90.2	44.0/22.0	401	26.81	68	A287
	20	3600	200	254T	NONE	U900	254TTDX4018		\$2,273	E2	91.0	53.0	214	20.57	B
3600		230/460	254T	NONE	E708A	254TTDX16010	✓	\$2,273	E2	91.0	48.0/24.0	243	22.10	13, 68	A612
3600		208-230/460	254T	NONE	U768	254TTDC6001	✓	\$2,509	E2	93.0	50.0-46.0/23.0	300	20.94	d, YD	A622
3600		575	254T	NONE	U289	254TTDC6003	✓	\$2,509	E2	93.0	18.4	300	20.94	YD	A622
1800		200	256T	NONE	E909A	256TTDR16027	✓	\$2,334	E2	93.6	57.0	260	22.10	B	N/A
1800		230/460	256T	NONE	E723B	256TTDX16032	✓	\$2,334	E2	93.6	49.0/24.5	259	22.10	13, 68	N/A
1800		230/460	256T	NONE	E723B-P	256TTDX16033	✓	\$2,780	E2	93.6	49.0/24.5	259	22.50	68, P	N/A
1800		208-230/460	256T	NONE	U769	256TTDC6026	✓	\$2,555	E2	93.0	55.0-51.0/25.5	360	22.60	YD	A622
1800		575	256T	NONE	E761A	—		\$2,334	E2	93.0	25.0	195	22.10		N/A
1800		575	256T	NONE	U290	256TTDC6029	✓	\$2,555	E2	93.0	19.2	360	22.60	YD	A626
1200		208-230/460	286T	NONE	U257	286TTDC6076	✓	\$2,577	E2	92.4	58.0-55.0/27.5	408	25.00	YD	A626
25		3600	200	256T	NONE	E786A	256TTDR16010	✓	\$3,090	E2	91.7	65.5	225	22.10	
	3600	230/460	256T	NONE	E709A	256TTDX16006	✓	\$3,090	E2	91.7	57.0/28.5	261	22.10	13, 68	N/A
	3600	575	256T	NONE	U291	256TTDC6003	✓	\$3,194	E2	93.0	23.0	315	22.60	YD	A626
	1800	200	284T	NONE	E910A	284TTDN16052	✓	\$3,108	E2	93.6	73.5	424	24.94		A287
	1800	230/460	284T	NONE	E1006	284TTDR16047	✓	\$2,907	E2	93.6	70.2/35.1	292	24.30	13, 68	A210
	1800	230/460	284T	NONE	E1006-P	284TTDR16048	✓	\$3,278	E2	93.6	70.2/35.1	292	24.68	68, P	A210
	1800	208-230/460	284T	NONE	U771	284TTDC6026	✓	\$3,108	E2	93.6	66.0-59.6/29.8	424	23.54	YD	A626
	1800	208-230/460	284TS	NONE	E793A	284TSTDN16031		\$3,108	E2	93.6	64.0/32.0	424	23.57		A287
	1800	575	284T	NONE	E762A	284TTDC6029	✓	\$3,108	E2	93.6	23.8	424	23.54	YD	A627
	1200	208-230/460	324T	NONE	U798	324TTDC6076	✓	\$4,893	E2	93.0	72.0-67.0/33.5	695	26.02	d, YD	A627
	900	230/460	326T	NONE	H191B	326TTDR16101		\$8,179	E2	91.0	73.0/36.5	469	28.50		N/A
	30	3600	230/460	284TS	NONE	E1008	284TSTDN16003	✓	\$3,540	E2	91.7	69.0/34.5	270	22.90	13, 68
3600		200	284TS	NONE	U901	284TSDP4004	✓	\$3,309	E2	91.0	83.0	320	22.06	d, B	A610
3600		200	284TS	NONE	U901A	284TSTDN16003	✓	\$3,951	E2	93.6	78.0	367	23.57		A287
3600		575	284TS	NONE	U292	284TSDC6003	✓	\$3,951	E2	94.1	28.1	396	22.17	YD	A626
1800		200	286T	NONE	E911A	286TTDN16073	✓	\$3,586	E2	94.1	85.0	485	26.81		A287
1800		230/460	286T	NONE	E1009	286TTDR16037	✓	\$3,323	E2	94.1	73.2/36.6	303	25.80	13, 68	A210
1800		230/460	286T	NONE	E1009-P	286TTDR16038	✓	\$3,784	E2	94.1	73.2/36.6	202	26.18	68, P	A210
1800		208-230/460	286T	NONE	U773	286TTDC6026		\$3,586	E2	94.1	78.0-71.0/35.5	483	25.00	YD	A626
1800		208-230/460	286TS	NONE	E794A	286TSTDN16036		\$3,586	E2	94.1	78.0-71.0/35.5	483	25.44		A287
1800		575	286T	NONE	E763A	286TTDC6029	✓	\$3,586	E9	94.1	28.6	483	25.00	YD	A627
1200		208-230/460	326T	NONE	U799	326TTDC6076		\$5,735	E2	93.6	86.3 - 78.0/39.0	550	27.52	YD	A627
40		3600	200	286TS	NONE	U902A	286TSTDN16011		\$4,756	E2	92.4	104	439	25.44	
	3600	230/460	286TS	NONE	E1010	286TSTDN16002	✓	\$4,356	E2	92.4	103.5/51.8	369	22.90	68	A210
	3600	575	286TS	NONE	U293	286TSDC6003	✓	\$4,756	E2	92.4	36.5	452	23.62	99, A, YD	A626
	1800	200	324T	NONE	E787	324TDP4030	✓	\$3,973	E2	94.1	112	542	26.00	d, B	A613
	1800	200	324T	NONE	E787A	324TTDR16054	✓	\$4,298	E2	94.1	112	540	28.00		A213
	1800	230/460	324T	NONE	U775-P	324TTDR16050	✓	\$4,756	E2	94.1	96.0/48.0	540	28.00	68, P	A213
	1800	208-230/460	326TS	NONE	E789A	326TSDP16032	✓	\$4,507	E2	94.1	100/50.0	581	26.00		A613
	1800	575	324T	NONE	E764A	324TTDC6029	✓	\$4,507	E2	94.1	38.0	581	26.02	YD	A627
	1200	208-230/460	364T	NONE	U1927	364TTDCA6086	✓	\$7,362	E2	94.1	107-100/50.0	875	31.60	YD	A626

Catalog numbers (Cat No.) highlighted in bold blue have efficiency levels that meet the USA efficiency legislations. Blue shaded areas are cast iron frames.

Continued on next page.

XRI® GENERAL PURPOSE, THREE PHASE MOTORS

DRIPPROOF MOTORS

HP	RPM	VOLTS	FRAME	OVER LOAD	CAT. NO.	MODEL NO.	STOCK	LIST PRICE	MULT. SYMB.	NOM. EFF.	F.L. AMPS	WT.	"C" DIM.	FOOT NOTES	C-FACE KITS
50	3600	200	324TS	NONE	U909A	324TSTDP16009		\$5,798	E2	93.0	129	527	24.50		A613
	3600	575	324TS	NONE	U294	324TSTDC6003	√	\$5,798	E2	93.0	44.8	590	24.53	13, YD	A627
	1800	200	326T	NONE	E790A	326TTDR16073		\$5,206	E2	94.5	139	535	28.50		A213
	1800	208-230/460	326TS	NONE	E791A	326TSTDR16034	√	\$5,206	E2	94.5	121/60.5	535	27.00	68, B	A213
	1800	230/460	326T	NONE	E791A-P	326TTDR16063	√	\$5,664	E2	94.5	121/60.5	535	27.38	68, P	A213
	1800	208-230/460	326T	NONE	U777	326TTDC6026	√	\$5,369	E2	94.5	130-118/59.0	710	27.52	YD	A627
60	1800	575	326T	NONE	E765A	326TTDC6029	√	\$5,369	E2	94.5	48.0	710	27.52	13, YD	A627
	1200	208-230/460	365T	NONE	U1928	365TTDCA6086		\$8,474	E2	94.1	134-125/62.5	1004	32.72	YD	A629
	3600	200	326TS	NONE	U910A	326TSTDP16014		\$6,936	E2	94.1	155	621	26.00		A613
	1800	208-230/460	364T	NONE	U1779	364TTDCA6060	√	\$6,386	E2	95.4	152-139/69.5	1077	31.60	19, 68, YD	A629
	1800	230/460	365T	NONE	E920A	365TTDS16326		\$6,386	E2	95.4	139/69.5	1005	29.64	YD	A216
	1800	208-230/460	365TS	NONE	E768C	365TSTDS16042	√	\$6,386	E2	95.4	153-139/69.5	1005	27.50		A219
75	1800	575	365T	NONE	E766A	365TTDS16067		\$6,386	E2	95.4	55.5	1005	29.62	YD	A216
	1200	230/460	404T	TSTAT	U270	404TTDS6086	√	\$10,200	E2	95.0	146/73.0	975	32.50	B	A222
	3600	208-230/460	364TS	NONE	U1782	364TSTDC6001		\$9,164	E2	93.6	190-170/85.0	705	29.49	13, YD	A629
	1800	230/460	365T	NONE	E921	365TTDS6060		\$7,648	E2	95.0	174/87.0	950	29.62	YD	A216
	1800	230/460	365T	NONE	U1783	365TTDCA6060		\$7,648	E2	95.0	174/87.0	950	29.62	YD	A216
	1800	208-230/460	365TS	NONE	E782C	365TSTDS16041	√	\$7,648	E2	95.0	194-174/87.0	1030	27.50		A219
100	1800	575	365T	NONE	E767A	365TTDS16064		\$7,648	E2	95.0	69.5	1030	29.62	YD	A216
	1200	230/460	405T	TSTAT	U271	405TTDS16081	√	\$12,536	E2	95.0	180/90.0	1100	34.00		A222
	3600	208-230/460	365TS	NONE	U1784	365TSTDC6001		\$11,215	E2	94.5	251-224/112	790	30.67	YD	A629
	1800	230/460	404T	NONE	E922	404TTDS6060	√	\$9,971	E2	95.4	226/113	1025	32.50	YD	A222
	1800	230/460	404TS	NONE	E780A	404TSTDS16036	√	\$9,971	E2	95.4	226/113	1025	29.50		A225
	1800	575	404T	NONE	U903A	404TTDS16055		\$9,971	E2	95.4	90.5	1025	32.50	YD	A222
125	1200	230/460	444T	TSTAT	U272	444TTDS16077	√	\$15,561	E2	95.4	234/117	1300	37.75		A228
	3600	460	404TS	NONE	U250	404TSTDS6001	√	\$13,416	E2	95.0	140	973	29.50	YD	A225
	1800	460	405T	NONE	E923	405TTDS6060	√	\$12,621	E2	95.4	141	1150	34.00	YD	A222
	1800	460	405TS	NONE	E781A	405TSTDS16038	√	\$12,621	E2	95.4	141	1150	31.00	PW	A225
	1800	575	405T	NONE	U904A	405TTDS16060		\$12,621	E2	95.4	113	1150	34.00	YD	A222
	1200	460	445T	TSTAT	U273	445TTDS16076	√	\$20,422	E2	95.0	145	1500	39.75	YD	A228
150	3600	460	405TS	NONE	U251	405TSTDS6007	√	\$16,892	E2	95.0	165	1075	31.00	YD	A225
	1800	460	444T	NONE	E924	444TTDS6060	√	\$16,943	E2	95.8	170	1275	37.75	YD	A228
	1800	460	444TS	NONE	E792A	444TSTDS16038	√	\$16,943	E2	95.8	170	1275	34.00	PW	A231
	1800	575	444T	NONE	U911A	444TTDS16043		\$16,943	E2	95.8	136	1275	37.75	YD	A228
	1200	460	447T	TSTAT	U274	447TTDN16077	√	\$20,998	E2	95.4	185	2050	43.25	25	N/A
	1200	460	447T	NONE	E796A	447TTDN16083		\$20,998	E2	95.4	185	2119	43.25		N/A
200	3600	460	444TS	TSTAT	U252	444TSTDS16003	√	\$24,421	E2	95.8	216	1277	34.00	YD	A231
	1800	460	445T	NONE	E925	445TTDS6060	√	\$21,259	E2	95.8	225	1500	39.75	YD	A228
	1800	460	445TS	NONE	U400A	445TSTDS16038	√	\$21,259	E2	95.8	225	1500	36.00	PW	A231
	1800	575	445T	NONE	U912A	445TTDS16041		\$21,259	E2	95.8	180	1500	39.75	YD	A228
	1200	460	447T	NONE	E797A	447TTDN16085		\$25,070	E2	95.4	245	2200	43.25	RB	N/A
	1200	460	449T	TSTAT	U275	449TTDN16076	√	\$25,070	E2	95.4	245	2200	48.25	YD	N/A
250	3600	460	447TS	NONE	U785	447TSTDN16004	√	\$28,442	E2	95.8	274	2028	39.50	YD	A293
	1800	460	447T	TSTAT	U786	447TTDN16046	√	\$26,262	E2	96.2	292	2220	43.25	YD	N/A
	1800	460	447T	NONE	E745A	447TTDN16058		\$26,262	E2	96.2	284	2220	43.25	25, B, PW, RB	N/A
	1200	460	447T	NONE	H822B	447TTDN16382		\$27,102	E2	95.8	310	2534	43.25	RB, YD	N/A
300	3600	460	447TS	NONE	U788	447TSTDN16007	√	\$33,180	E2	95.4	330	1745	39.50	YD	A293
	1800	460	447T	NONE	U789	447TTDN16041		\$29,739	E2	96.2	340	2179	43.25	YD	N/A
	1800	460	447TS	NONE	U496	447TSTDN16036	√	\$29,739	E2	96.2	340	2179	39.58	68, YD	A293
	1200	460	449T	NONE	U790	449TTDN16077		\$39,307	E2	95.8	365	2112	48.25	YD	N/A
350	3600	460	447TS	NONE	U791	447TSTDN16008	√	\$36,497	E2	95.4	385	1745	39.50	YD	A293
	1800	460	447TS	NONE	U497	447TSTDN16047	√	\$32,093	E2	95.8	395	2298	39.50	68, YD	A293
	1200	460	449T	TSTAT	H821B	508UTDS16077		\$44,442	E2	95.8	420	2388	50.32	17, YD	N/A
400	3600	460	449TS	NONE	U793	449TSTDN16003	√	\$42,188	E2	95.8	450	2508	44.50	68, H, YD	A293
	1800	460	447T	NONE	U794	447TTDN16048		\$34,886	E2	95.8	460	2283	43.25	YD	A293
	1800	460	447TS	NONE	U498	449TSTDN16046	√	\$34,886	E2	96.5	452	2220	39.50	68, YD	A293
450	3600	460	449TS	NONE	U795	449TSTDN16004	√	\$53,325	E2	96.2	495	2112	44.50	YD	A293
	1800	460	449TS	NONE	U796	449TSTDN16040	√	\$40,727	E2	96.2	505	2511	44.50	17, 68, YD	A293
500	3600	460	449TS	NONE	U797	449TSTDN16005	√	\$59,407	E2	96.2	538	2649	44.50	68, H, YD	A293
	1800	460	449TS	NONE	U499	449TSTDN16041		\$42,056	E2	95.8	560	2695	44.50	YD	A293

Catalog numbers (Cat No.) highlighted in bold blue have efficiency levels that meet the USA efficiency legislations.

Blue shaded areas are cast iron frames.

GENERAL PURPOSE MOTORS

THREE PHASE, DRIPPROOF MOTORS

56, 56H, AND 56HZ FRAME MOTORS

FEATURES:

- Rolled steel construction
- Class B insulation except as noted
- 1.15 Service factor (except as noted)
- 60/50 hertz at next lower horsepower, as noted
- UL recognized and CSA certified
- Meets or exceeds all USA mandated efficiencies

180 FRAME AND GREATER MOTORS

FEATURES:

- Rolled steel construction
- Class F insulation
- 1.15 Service factor (except as noted)
- 6:1 Variable Torque
- 60/50Hz (50Hz @ next lower HP, 1.15SF)
- UL recognized and CSA certified
- Meets or exceeds all USA mandated efficiencies



RIGID BASE

HP	RPM	VOLTS	FRAME	OVER LOAD	CAT. NO.	MODEL NO.	STOCK	LIST PRICE	MULT. SYMB.	NOM. EFF.	FL. AMPS	WT.	"C" DIM.	FOOT NOTES
1/4	1200	230/460	56	None	H204ES	Century*	√	\$702	F1	67.5	1.2/6	21	11.22	20, 68
1/3	1800	230/460	56	None	H262LES	Century	√	\$496	F1	73.4	1.2/6	21	11.22	20, 68
	1200	230/460	56	None	H267ES	Century	√	\$714	F1	71.4	1.4/7	27	11.94	20, 68
1/2	3600	230/460	56	None	H437ES	Century	√	\$443	F1	73.4	1.8/0.9	21	10.89	68, 114
	1800	230/460	56	None	H273LES	Century	√	\$646	F1	78.2	1.7/0.85	25	11.32	19, 68
	1800	230/460	56	Auto	H880LES	Century	√	\$709	F1	78.2	1.8/0.9	26	11.99	19
	1800	575	56	None	H991LES	Century	√	\$646	F1	78.2	0.7	21	11.32	19
	1200	230/460	56	None	H279ES	Century	√	\$854	F1	75.3	1.9/0.95	25	11.70	19, 68
3/4	3600	230/460	56	None	H377ES	Century	√	\$540	F1	76.8	2.2/1.1	23	11.32	19, 68
	1800	230/460	56	None	OB3075ES	Century	√	\$721	F1	81.1	2.5/1.25	31	11.32	19
	1800	230/460	56	None	H581AES	Century	√	\$721	F1	81.1	2.5/1.25	31	11.32	19, 68
	1800	230/460	56	Auto	H881ES	Century	√	\$749	F1	81.1	2.6/1.3	30	12.49	19, 140
	1800	575	56	None	H992LES	Century	√	\$721	F1	81.1	1.0	22	11.32	19
1	1200	230/460	56H	None	H467ES	Century	√	\$913	F1	81.7	3.2/1.6	29	14.03	19, 68
	3600	230/460	56	None	H602ES	Century	√	\$599	F1	77.0	3.0/1.5	24	11.05	68, 112
	1800	230/460	56	None	OB3104ES	Century	√	\$767	F1	83.5	3.0/1.5	34	11.75	
	1800	230/460	56H	None	H614LES	Century	√	\$767	F1	83.5	3.0/1.5	36	11.69	19, 68
	1800	208-230/460	56H	Auto	H882LES	Century	√	\$801	F1	83.5	3.5-3.35/1.65	43	13.99	
	1800	200-230/460	56HZ	Auto	H883L	Century	√	\$740	F1	74.6	3.5-3.8/1.9	27	12.60	Z
	1800	575	56	None	H993LES	Century	√	\$767	F1	83.5	1.2	25	11.69	19
1 1/2	1200	230/460	56H	None	H526ES	Century	√	\$999	F1	82.5	1.0/2.0	32	14.50	17, 68
	1800	230/460	56H	None	OB3154ES	Century	√	\$852	F1	86.5	4.7/2.35	28	13.96	68, 110
	1800	230/460	56H	None	H534LES	Century	√	\$852	F1	86.5	4.7/2.35	45	13.80	68, 110
	1800	208-230/460	56H	Auto	H884LES	Century	√	\$988	F1	86.5	4.4-4.4/2.2	39	13.99	
	1800	200-230/460	56HZ	Auto	H885L	Century	√	\$835	F1	74.3	5.0-5.6/2.8	29	12.90	
	1800	575	56HZ	Auto	H951V1	Century	√	\$835	F1	76.6	2.0	32	13.10	Z, 110
	1200	208-230/460	182T	None	E206M2	Century	√	\$863	E2	86.5	6.2/3.1	69	13.19	14, 57
2	3600	230/460	56H	Auto	BR3202LES	Century	√	\$1,213	F1	85.5	6.0/3.0	40	13.90	110
	1800	230/460	56H	None	OB3204ES	Century	√	\$934	F1	86.5	6.0/3.0	48	13.44	
	1800	200-230/460	56HZ	None	OB3204V1	Century	√	\$752	F1	82.8	7.4/3.7	33	13.20	Z
	1800	230/460	56H	None	H181LES	Century	√	\$818	F1	86.5	6.0/3.0	46	13.44	68
	1800	200-230/460	56HZ	Auto	H886L	Century	√	\$918	F1	82.8	7.0-6.6/3.5	37	13.80	
	1800	230/460	56H	Auto	H1045LES	Century	√	\$875	F1	86.5	6.0/3.0	37	14.49	110
	1800	575	56HZ	Auto	H953V1	Century	√	\$918	F1	76.1	2.6	31	13.10	110
	1800	575	56	None	H965V1ES	Century	√	\$849	F1	86.5	2.4	47	13.44	110
	1200	208-230/460	184T	None	E207M2	Century	√	\$1,155	E2	88.5	7.15/3.6	95	15.19	14, 57
3	3600	200-230/460	56HZ	Auto	H757	Century	√	\$1,064	F1	82.7	9.0-8.6/4.3	35	13.80	Z, Q
	1800	200	182T	None	E216M2	Century	√	\$1,003	E2	89.5	9.2	81	13.19	14, 57
	1800	200-230/460	56HZ	Auto	H887L	Century	√	\$999	F1	83.1	9.0-8.8/4.4	43	14.60	F, Z
	1800	230/460	56HZ	None	H539L	Century	√	\$817	F1	83.1	9.2/4.6	42	14.60	Z
	1800	208-230/460	182T	None	E217M2	Century	√	\$1,003	E2	89.5	8.4-8.0/4.0	71	13.19	14, 57
	1800	575	56HZ	Auto	H955L	Century	√	\$1,013	F1	79.2	3.7	42	14.90	Z
	1800	575	182T	None	E923M2	Century	√	\$1,003	E2	89.5	3.2	71	13.19	14, 57
	1200	208-230/460	213T	None	E394M2	Century	√	\$1,584	E2	88.5	9.4-9.0/4.5	104	17.30	d, 14

Catalog numbers (Cat No.) highlighted in bold blue have efficiency levels that meet the USA efficiency legislations.

Continued on next page.

GENERAL PURPOSE MOTORS

THREE PHASE, DRIPPROOF MOTORS

HP	RPM	VOLTS	FRAME	OVER LOAD	CAT. NO.	MODEL NO.	STOCK	LIST PRICE	MULT. SYMB.	NOM. EFF.	FL. AMPS	WT.	"C" DIM.	FOOT NOTES
5	3600	208-230/460	56HZ	Auto	H847	Century®	√	\$1,257	F1	85.0	13.4-13.2/6.6	44	15.1	Z
	3600	575	56HZ	Auto	H956	Century	√	\$1,257	F1	85.0	5.4	44	15.10	Z
	3600	208-230/460	182T	None	E204M2	Century	√	\$1,057	E2	86.5	13.4-12.4/6.2	64	13.19	14, 57
	1800	200	184T	None	E218M2	Century	√	\$1,128	E2	89.5	14.5	80	14.19	14, 57
	1800	208-230/460	184T	None	E219M2	Century	√	\$1,128	E2	89.5	13.6-12.6/6.3	81	14.19	14, 57
	1800	575	184T	None	E924M2	Century	√	\$1,128	E2	89.5	5.1	80	14.19	14, 57
	1200	208-230/460	215T	None	E395M2	Century	√	\$1,843	E2	89.5	15-13.8/6.9	125	18.55	d, 14
7 1/2	3600	230/460	184T	None	E205M2	Century	√	\$1,666	E2	88.5	17.8/8.9	86	14.69	14, 57
	1800	200	213T	None	E316M2	Century	√	\$1,511	E2	91.0	21.4	122	17.51	
	1800	230/460	213T	None	E317M2	Century	√	\$1,531	E2	91.7	19.4/9.7	123	17.51	
	1800	575	213T	None	E925M2	Century	√	\$1,461	E2	91.0	3.2	122	17.51	
	1200	230/460	254T	None	E496M2	Century	√	\$2,304	E2	90.2	21.0/10.5	225	22.10	
10	3600	208-230/460	213T	None	E392M2	Century	√	\$1,666	E2	89.5	26-23.4/11.7	111	17.30	d, 14
	1800	200	215T	None	E331M2	Century	√	\$1,605	E2	91.7	29.2	139	17.51	
	1800	230/460	215T	None	E397M2	Century	√	\$1,723	E2	91.7	25.2/12.6	129	17.51	
	1800	575	215T	None	E926M2	Century	√	\$1,723	E2	91.7	10.1	122	17.51	
	1200	230/460	256T	None	E497M2	Century	√	\$2,873	E2	91.7	27.4/13.7	300	23.85	
15	3600	208-230/460	215T	None	E393M2	Century	√	\$2,177	E2	91.0	39.0-35.0/17.5	139	18.55	d, 14, 19
	1800	200	254T	None	E450M2	Century	√	\$2,512	E2	93.0	43.4	234	22.10	
	1800	230/460	254T	None	E451M2	Century	√	\$2,501	E2	93.0	37.8/18.9	237	22.10	57
	1800	575	254T	None	E927M2	Century	√	\$2,387	E2	93.0	15.1	236	22.10	
	1200	230/460	284T	None	E586M2	Century	√	\$3,783	E2	91.7	43.0/21.5	317	24.22	
20	3600	230/460	254T	None	E494M2	Century	√	\$2,814	E2	91.0	48.0/24.0	256	22.10	
	1800	200	256T	None	E452M2	Century	√	\$3,111	E2	93.6	57.0	265	22.10	
	1800	230/460	256T	None	E407M2	Century	√	\$2,955	E2	93.6	49.0/24.5	269	22.10	57
	1800	575	256T	None	E928M2	Century	√	\$2,955	E2	93.0	19.6	266	22.10	
25	3600	230/460	256T	None	E495M2	Century	√	\$3,583	E2	91.7	57.0/28.5	271	22.10	
	1800	200	284T	None	E513M2	Century	√	\$3,670	E2	93.6	70.0	320	24.22	
	1800	230/460	284T	None	E514M2	Century	√	\$3,653	E2	93.6	61.0/30.5	307	24.22	57
	1800	575	284T	None	E929M2	Century	√	\$3,486	E2	93.6	24.5	300	24.22	
30	3600	230/460	284TS	None	E584M2	Century	√	\$4,432	E2	91.7	69.0/34.5	280	22.85	
	1800	200	286T	None	E515M2	Century	√	\$4,233	E2	94.1	82.2	355	25.75	
	1800	230/460	286T	None	E516M2	Century	√	\$4,215	E2	94.1	73.2/36.6	351	25.75	
	1800	575	286T	None	E930M2	Century	√	\$4,022	E2	94.1	28.5	351	25.75	
40	3600	230/460	286TS	None	E585M2	Century	√	\$5,335	E2	92.4	90.0/45.0	330	22.85	

Catalog numbers (Cat No.) highlighted in bold blue have efficiency levels that meet the USA efficiency legislations.

XRI® GENERAL PURPOSE MOTORS

THREE PHASE, DRIPPROOF MOTORS

APPLICATIONS:

General purpose use on gear reducers, pumps, machine tools, and other direct coupled equipment installed in environments that are relatively clean and dry.

ADDITIONAL FEATURES:

- Ball bearings, mechanically locked on shaft end (excludes 5K models)
- NEMA® service factors



C-FACE FOOTLESS

HP	RPM	VOLTS	FRAME	CAT. NO.	MODEL NO.	STOCK	LIST PRICE	MULT. SYMB.	NOM. EFF.	FL. AMPS	WT.	"C" DIM.	FOOT NOTES	
1/4	1800	230/460	56C	K247A	056T17D11053	√	\$343	F1	69.5	1.0/0.5	22	11.19	13, 68	
1/3	3600	208-230/460	56C	KG215	5K35FN55	√	\$282	F1	61.0	1.5-1.8/0.9	14.0	9.88	68, 115	
	1800	230/460	56C	K248A	056T17D11050	√	\$397	F1	73.4	1.2/0.6	20	11.44	13, 68	
1/2	3600	208-230/460	56C	K216	5K36JN57	√	\$320	F1	69.8	2.0-2.0/1.0	16	10.31	68, 114	
	1800	208-230/460	56C	K249	5K42HN4127	√	\$426	F1	74.7	2.3-2.2/1.1	22	9.90	d, 68	
	1800	230/460	56C	K249A	056T17D15909	√	\$510	F1	78.2	1.7/0.85	28	11.32	68	
	1800	575	56C	G242A	056T17D11045	√	\$510	F1	78.2	0.7	28	11.32	19	
3/4	1200	230/460	56C	K1299A	056T11D15523	√	\$676	F1	75.3	2.8/1.4	28	11.95	13, 68	
	3600	230/460	56C	G205A	056T34D15594	√	\$443	F1	76.8	2.2/1.1	28	14.91	68	
	3600	208-230/460	56C	K218	5K37MN37	√	\$386	F1	73.2	2.6-2.6/1.3	17	10.71	48, 68, 113	
	1800	230/460	56C	K250A	056T17D15906	√	\$571	F1	81.1	2.6/1.3	30	11.50	68	
1	1800	575	56C	G243A	056T17D11042	√	\$571	F1	81.1	2.9	30	11.57	19	
	1200	230/460	56C	K1300A	056T11D15524	√	\$698	F1	81.7	3.5/1.75	42	14.03	68	
	3600	208-230/460	56C	K220	5K38PN47	√	\$438	F1	76.1	3.3-3.2/1.6	19	11.31	48, 68, 112	
	1800	230/460	56C	K251A	056T17D15916	√	\$612	F1	83.5	3.0/1.5	40	11.94	68	
1	1800	230/460	56C	K251B	056T17D15956	√	\$650	F1	85.5	3.0/1.5	40	11.94	68	
	1800	230/460	143TC	K634A	143TTDR14049	√	\$582	E2	82.5	3.1/1.55	38	12.49	d, 13, 68	
	1800	230/460	143TC	K634B	143TTDR16057	√	\$650	E2	85.5	3.0/1.5	42	13.50	13, 68	
	1800	575	56C	G244A	056T17D11048	√	\$582	F1	83.5	1.2	34	11.94	18	
	1200	230/460	145TC	C150A	145TTDR14088	√	\$804	E2	80.0	3.6/1.8	46	13.49	d, 13, 68	
	1200	230/460	145TC	C150B	145TTDR16085	√	\$820	E2	82.5	3.8/1.9	47	13.50	13, 68	
	1 1/2	3600	208-230/460	56C	K222	5K46KN2173	√	\$534	F1	77.3	5.0-4.8/2.4	24	10.73	48, 68, 111
		3600	230/460	143TC	K2018A	143TTDR16021	√	\$650	E2	84.0	4.0/2.0	45	12.19	13, 68
1800		230/460	56C	K521A	056T17D15912	√	\$640	F1	86.5	4.6/2.3	44	13.78	68	
1800		230/460	145TC	K622A	145TTDR14049	√	\$601	E2	84.0	4.4/2.2	38	12.49	d, 13, 68	
1800		230/460	145TC	K622B	145TTDR16360	√	\$640	E2	86.5	4.4/2.2	48	13.50	13, 68	
1200		230/460	182TC	C162B	—	√	\$920	E2	86.5	6.2/3.1	68	13.19	13	
2	3600	230/460	145TC	C102A	145TTDR14007	√	\$757	E2	84.0	5.4/2.7	30	10.99	d, 13, 68	
	3600	230/460	145TC	C102B	145TTDR16403	√	\$780	E2	86.5	5.6/2.8	33	10.99	13, 68	
	3600	208-230/460	56C	K224	5K49NN2180	√	\$625	F1	80.2	6.0-6.0/3.0	29	11.33	48,68,110	
	1800	230/460	56C	K644A	056T17D15718	√	\$670	F1	86.5	6.0/3.0	46	13.44	13, 68	
	1800	230/460	145TC	C122B	145TTDR16359	√	\$670	E2	86.5	6.0/3.0	46	14.00	13, 68	
	1800	208-230/460	145TC	K2043	5KE49UN8428	√	\$588	E2	84.0	6.4-6.0/3.0	44	12.62	24, 68	
3	1200	230/460	184TC	C152B	184TTDW16082	√	\$1,058	E2	88.5	7.2/3.6	84	15.28	68	
	3600	208-230/460	56C	G289A	056T34D15597	√	\$736	F1	85.5	7.2/3.6	28	14.03	68	
	3600	208-230/460	56C	K226	5K48TN2182	√	\$701	F1	82.4	8.9-8.2/4.1	38	12.61	18, 48, 68	
	3600	230/460	145TC	C103A	145TTDR16319	√	\$897	E2	87.5	7.6/3.8	58	12.99	13, 68	
	1800	230/460	182TC	C123B	182TTDW4028	√	\$846	E2	86.5	8.8/4.4	60	12.78	d, 13, 68	
5	1800	230/460	182TC	C123C	182TTDW16065	√	\$910	E2	89.5	8.0/4.0	73	13.28	13, 68	
	3600	230/460	182TC	C104C	182TTDW16019	√	\$980	E2	86.5	—	90	13.73	13, 68	
	1800	230/460	184TC	C124C	184TTDW16068	√	\$950	E2	89.5	12.6/6.3	65	14.28	68	
7 1/2	3600	230/460	184TC	C105C	184TTDW16304	√	\$1,008	E2	88.5	17.8/8.9	90	14.78	68	
	1800	230/460	213TC	C125B	—	√	\$1,002	E2	91.0	20.0/10.0	135	18.25	68	
	1200	230/460	254TC	C155B	—	√	\$2,002	E2	90.2	21.0/10.5	240	22.40	13	
10	3600	230/460	213TC	C106B	213TTDWD16024	√	\$1,260	E2	90.2	24.2/12.1	101	18.03	68	
	1800	230/460	215TC	C126B	215TTDW16340	√	\$1,310	E2	91.7	25.0/12.5	155	19.28	13, 68	
	1200	230/460	256TC	C156B	—	√	\$2,228	E2	91.7	27.4/13.7	305	23.90	13	

Catalog numbers (Cat No.) highlighted in bold blue have efficiency levels that meet the USA efficiency legislations.

GEN. PURPOSE THREE PHASE

XRI® GENERAL PURPOSE MOTORS

THREE PHASE, DRIPPROOF MOTORS

APPLICATIONS:

General purpose use on gear reducers, pumps, machine tools, and other direct coupled equipment installed in environments that are relatively clean and dry.

ADDITIONAL FEATURES:

- Ball bearings, mechanically locked on shaft end (excludes 5K models)
- NEMA® service factors



C-FACE FOOTED (RIGID BASE)

HP	RPM	VOLTS	FRAME	CAT. NO.	MODEL NO.	STOCK	CT SPEED RANGE*	LIST PRICE	MULT. SYMB.	NOM. EFF.	F.L. AMPS	WT.	"C" DIM.	FOOT NOTES
1/3	1800	230/460	56C	K1305A	056T17D11052	✓	2:1	\$434	F1	73.4	1.2/6	22	11.44	13, 68
1/2	3600	230/460	56C	K1306A	056T34D15603	✓	2:1	\$410	F1	72.4	1.8/0.9	17	11.06	13, 68, 114
	1800	230/460	56C	K1307A	056T17D15910	✓	2:1	\$553	F1	78.2	1.7/0.85	30	11.31	13, 68
3/4	1800	230/460	56C	K1308A	056T17D15907	✓	2:1	\$612	F1	81.1	2.6/1.3	32	11.50	13, 68
1	1800	230/460	143TC	K2021A	143TTDR16068		2:1	\$653	E2	85.5	3.2/1.6	43	12.19	13
	1800	230/460	56HC	K635A	056T17D15917	✓	2:1	\$622	F1	83.5	3.0/1.5	36	11.94	13, 68
1 1/2	3600	230/460	56C	K690A	056T34D15601	✓	2:1	\$596	F1	84.0	4.2/2.1	26	12.44	5, 13, 68
	1800	230/460	145TC	K2022A	145TTDR16365	✓	2:1	\$689	E2	86.5	4.8/2.4	45	12.69	13
	1800	230/460	56HC	K646A	056T17D15914	✓	2:1	\$682	F1	86.5	4.6/2.3	46	12.44	5, 13, 68
2	3600	230/460	56C	K1311A	056T34D15602	✓	2:1	\$725	F1	85.5	5.4/2.7	37	13.44	13, 68
	1800	230/460	145TC	K2023A	145TTDR16366	✓	2:1	\$747	E2	86.5	5.8/3.2	75	13.19	13
	1800	230/460	56HC	K648A	056T17D15717	✓	2:1	\$653	F1	86.5	6.0/3.0	47	13.44	5, 13, 68
3	3600	230/460	145TC	U401A	145TTDR16308	✓	2:1	\$912	E2	86.5	7.2/3.6	70	12.69	13, 68
	1800	230/460	182TC	U410A	182TTDW16059	✓	2:1	\$920	E2	89.5	8.0/4.0	71	14.19	13, 68
5	3600	230/460	182TC	U402C	182TTDW16010	✓	2:1	\$1,092	E2	86.5	12.4/6.2	65	13.20	68
	1800	230/460	184TC	U403A	184TTDW16043		2:1	\$1,056	E2	89.5	12.0/6.3	89	14.20	68
7 1/2	3600	230/460	184TC	U404B	184TTDW16001	✓	2:1	\$1,290	E2	88.5	17.8/8.9	85	14.20	68
	1800	230/460	213TC	U405A	213TTDW16063	✓	2:1	\$1,310	E2	91.0	19.2/9.6	126	19.28	d, 68
	1800	230/460	213TC	U405B	213TTDWD16063	✓	2:1	\$1,310	E2	91.0	20.0/10.0	110	18.03	68
10	3600	230/460	213TC	U432A	213TTDW16010		2:1	\$1,399	E2	89.5	23.4/11.7	127	18.03	YD, 68
	1800	230/460	215TC	U433A	215TTDW16061		2:1	\$1,401	E2	91.7	25.0/12.5	144	19.28	YD, 68
15	3600	230/460	215TC	U435	215TTDW4315		2:1	\$2,150	E2	90.2	34.0/17.0	128	19.28	YD, 13, 68
	1800	230/460	254TC	U436A	254TTDN16056	✓	2:1	\$2,615	E2	93.0	37.0/18.5	306	23.31	YD, 68
20	3600	230/460	254TC	U437	254TTDX4315		2:1	\$2,574	E2	91.0	46.0/23.1	200	20.89	YD, 68
	1800	230/460	256TC	U438A	256TTDN16049		2:1	\$3,116	E2	93.0	48.0/24.0	369	24.81	YD, 68
25	3600	230/460	256TC	U439A	256TTDN16009		2:1	\$3,594	E2	92.4	58.0/29.0	243	24.81	YD, 68
	1800	230/460	286TSC	U440A	286TSTDN16034		2:1	\$3,769	E2	93.6	61.0/30.5	521	25.44	YD, 68
30	3600	230/460	286TSC	U441A	286TSTDN16005	✓	2:1	\$4,431	E2	93.6	67.5/34.0	450	25.45	YD, 68
	1800	230/460	286TSC	U442A	286TSTDN16033		2:1	\$4,294	E2	94.1	73.0/36.5	482	25.44	YD, 68
40	3600	230/460	286TSC	U443A	286TSTDN16004		2:1	\$5,511	E2	93.6	90.0/45.0	459	25.45	YD, 68
	1800	230/460	324TSC	U444A	324TSTDP16032		—	\$5,447	E2	94.1	100/50.0	522	24.50	YD, 68
50	3600	230/460	324TSC	U445A	324TSTDP16002	✓	—	\$6,687	E2	93.6	112/56.0	477	24.50	YD, 68
	1800	230/460	326TSC	U446A	326TSTDR16035		—	\$6,217	E2	94.5	121/60.5	468	27.00	YD
60	3600	230/460	326TSC	U447A	326TSTDP16005	✓	—	\$7,495	E2	94.1	135/67.5	483	26.00	YD, 68
	1800	230/460	365TSC	U448A	365TSTDS16044	✓	—	\$7,800	E2	95.0	139/69.5	748	27.50	YD, 68
75	3600	230/460	365TSC	U449A	365TSTDS16008		—	\$10,889	E2	94.5	170/85.0	732	27.50	YD, 68
	1800	230/460	365TSC	U450A	365TSTDS6074		—	\$9,245	E2	95.0	174/87.0	798	27.50	YD, 68
100	3600	230/460	365TSC	U451A	365TSTDS16005		—	\$11,215	E2	94.1	230/115	795	27.50	YD, 68
	1800	230/460	404TSC	U452A	404TSTDS6327		—	\$12,042	E2	95.4	226/113	1034	29.50	YD, 68
125	3600	460	404TSC	U453A	404TSTDS16006	✓	—	\$15,490	E2	95.0	138	1018	29.50	YD, 68
	1800	460	405TSC	U454A	405TSTDS16039		—	\$14,078	E2	95.4	141	1132	29.50	YD, 68
150	3600	460	405TSC	U455A	405TSTDS16005		—	\$19,466	E2	95.0	165	1080	31.00	YD, 68
	1800	460	444TSC	U456A	444TSTDS16034		—	\$19,729	E2	95.8	170	1376	34.00	YD, 13

Catalog numbers (Cat No.) highlighted in bold blue have efficiency levels that meet the USA efficiency legislations.

* Requires nameplate modification.

Blue shaded areas are cast iron frames.

GLOBETROTTER® GENERAL PURPOSE MOTORS

THREE PHASE, DRIPPROOF MOTORS

FEATURES:

- Meets or exceeds NEMA Premium® efficiencies
- NEMA Premium models are in compliance with EISA2007
- 182T-365T models steel frame, 404T-449T models cast iron frame
- Inverter duty 10:1 variable torque and 2:1 constant torque, 1.0 SF
- 1.15 service factor
- Class F insulation
- Standard assembly F1, reversible to F2 assembly
- Dual frame mounting holes
- UL recognized, CSA certified, CE mark
- Three year warranty



RIGID BASE

HP	RPM	VOLTS	FRAME	CAT. NO.	MODEL NO.	STOCK	LIST PRICE	MULT. SYMB.	NOM. EFF.	FL. AMPS	WT.	"C" DIM.	FOOT NOTES	C-FACE KITS
1	1800	200	143T	TO103	Century®	✓	\$715	E1	85.5	3.2	51	11.20		WD140TCDR
	1800	230/460	143T	TO101	Century	✓	\$700	E1	85.5	2.7/1.4	51	11.20		WD140TCDR
	1800	575	143T	TO102	Century	✓	\$700	E1	85.5	1.1	51	11.20		WD140TCDR
	1200	230/460	145T	TO100	Century	✓	\$799	E1	82.5	3.2/1.6	56	12.20		WD140TCDR
1 1/2	3600	230/460	143T	TO108	Century	✓	\$720	E1	84.0	4.3-3.9/1.9	53	11.20		WD140TCDR
	1800	200	145T	TO107	Century	✓	\$770	E1	86.5	4.5	58	12.20		WD140TCDR
	1800	230/460	145T	TO105	Century	✓	\$770	E1	86.5	4.3-3.9/2.0	58	12.20		WD140TCDR
	1800	575	145T	TO106	Century	✓	\$770	E1	86.5	1.6	58	12.20		WD140TCDR
	1200	230/460	182T	GT0005	182TTDB6076	✓	\$790	E1	86.5	4.4/2.2	75	13.72	d	A160
	1200	230/460	182T	GT0005A	182TTDBD6076	✓	\$790	E1	86.5	4.4/2.2	75	13.72		A160
	1200	230/460	182T	TO104	Century	✓	\$913	E1	86.5	4.4/2.2	75	13.72	d	WD180TCDR
	1200	230/460	182T	TO104A	Century	✓	\$913	E1	86.5	4.4/2.2	75	13.72		WD180TCDR
2	3600	230/460	145T	TO113	Century	✓	\$849	E1	85.5	5.5-5.0/2.5	60	12.20		WD140TCDR
	1800	200	145T	TO110	Century	✓	\$844	E1	86.5	5.9	60	12.20		WD140TCDR
	1800	230/460	145T	TO111	Century	✓	\$830	E1	86.5	5.6-5.1/2.5	60	12.20		WD140TCDR
	1800	575	145T	TO112	Century	✓	\$830	E1	86.5	2.0	60	12.20		WD140TCDR
	1200	230/460	184T	GT0008	184TTDB6076	✓	\$793	E1	87.5	5.8/2.9	99	14.72	d	A160
	1200	230/460	184T	GT0008A	184TTDBD6076	✓	\$793	E1	87.5	5.8/2.9	99	14.72		A160
	1200	230/460	184T	TO109	Century	✓	\$929	E1	87.5	5.8/2.9	99	14.72	d	WD180TCDR
	1200	230/460	184T	TO109A	Century	✓	\$929	E1	87.5	5.8/2.9	99	14.72		WD180TCDR
3	3600	230/460	145T	TO118	Century	✓	\$859	E1	85.5	8.3-7.3/3.7	62	12.20		WD140TCDR
	1800	200	182T	TO117	Century	✓	\$866	E1	89.5	8.9	76	13.72	d	WD180TCDR
	1800	200	182T	TO117A	Century	✓	\$866	E1	89.5	8.9	76	13.72		WD180TCDR
	1800	230/460	182T	GT0010	182TTDB6026	✓	\$689	E1	89.5	7.8/3.9	76	13.72	d	A160
	1800	230/460	182T	GT0010A	182TTDBD6026	✓	\$689	E1	89.5	7.8/3.9	76	13.72		A160
	1800	230/460	182T	TO115	Century	✓	\$808	E1	89.5	7.8/3.9	76	13.72	d	WD180TCDR
	1800	230/460	182T	TO115A	Century	✓	\$808	E1	89.5	7.8/3.9	76	13.72		WD180TCDR
	1800	575	182T	TO116	Century	✓	\$822	E1	89.5	3.1	76	13.72	d	WD180TCDR
	1800	575	182T	TO116A	Century	✓	\$822	E1	89.5	3.1	76	13.72		WD180TCDR
	1200	230/460	213T	GT0011	213TTDB6076	✓	\$1,088	E1	88.5	8.8/4.4	156	17.52	d	A161
	1200	230/460	213T	GT0011A	213TTDBD6076	✓	\$1,088	E1	88.5	8.4/4.2	156	17.52		A161
	1200	230/460	184T	TO114	Century	✓	\$1,275	E1	88.5	8.8/4.4	156	17.52	d	WD180TCDR
1200	230/460	184T	TO114A	Century	✓	\$1,275	E1	88.5	8.4/4.2	156	17.52		WD180TCDR	
5	3600	230/460	182T	GT0012	182TTDB6001	✓	\$726	E1	86.5	11.8/5.9	126	13.72	d	A160
	3600	230/460	182T	GT0012A	182TTDBD6001	✓	\$726	E1	86.5	11.8/5.9	126	13.72		A160
	3600	230/460	182T	TO123	Century	✓	\$852	E1	86.5	11.8/5.9	126	13.72	d	WD180TCDR
	3600	230/460	182T	TO123A	Century	✓	\$852	E1	86.5	11.8/5.9	126	13.72		WD180TCDR
	1800	200	184T	TO122	Century	✓	\$925	E1	89.5	15.0	86	14.72	d	WD180TCDR
	1800	200	184T	TO122A	Century	✓	\$925	E1	89.5	15.0	86	14.72		WD180TCDR
	1800	230/460	184T	GT0013	184TTDB6026	✓	\$775	E1	89.5	12.4/6.2	86	14.72	d	A160
	1800	230/460	184T	GT0013A	184TTDBD6026	✓	\$775	E1	89.5	12.4/6.2	86	14.72		A160
	1800	575	184T	TO121	Century	✓	\$925	E1	89.5	5.2	86	14.72	d	WD180TCDR
	1800	575	184T	TO121A	Century	✓	\$925	E1	89.5	5.2	86	14.72		WD180TCDR
	1200	230/460	215T	GT0014	215TTDB6076	✓	\$1,265	E1	89.5	14.0/7.0	281	17.52	d	A161
	1200	230/460	215T	GT0014A	215TTDBD6076	✓	\$1,265	E1	89.5	13.7/6.9	281	19.95		A161
	1200	230/460	215T	TO119	Century	✓	\$1,484	E1	89.5	14.0/7.0	281	17.52	d	WD210TCDR
	1200	230/460	215T	TO119A	Century	✓	\$1,484	E1	89.5	13.7/6.9	281	19.95		WD210TCDR

Catalog numbers (Cat No.) highlighted in bold blue are premium efficient.

Continued on next page.

GEN. PURPOSE THREE PHASE

GLOBETROTTER® GENERAL PURPOSE MOTORS

THREE PHASE, DRIPPROOF MOTORS

RIGID BASE

HP	RPM	VOLTS	FRAME	CAT. NO.	MODEL NO.	STOCK	LIST PRICE	MULT. SYMB.	NOM. EFF.	FL. AMPS	WT.	"C" DIM.	FOOT NOTES	C-FACE KITS	
7 1/2	3600	230/460	184T	GT0015	184TTDB6001	✓	\$893	E1	88.5	17.0/8.5	143	14.72	d, A	A160	
	3600	230/460	184T	GT0015A	184TTDB6001	✓	\$893	E1	88.5	17.0/8.5	143	14.72		A160	
	3600	230/460	184T	TO128	Century®	✓	\$1,047	E1	88.5	17.0/8.5	143	14.72	d, A	WD180TCDR	
	3600	230/460	184T	TO128A	Century	✓	\$1,047	E1	88.5	17.0/8.5	143	14.72		WD180TCDR	
	1800	200	213T	TO127	Century	✓	\$1,239	E1	91.0	7.7	160	17.52	d	WD210TCDR	
	1800	200	213T	TO127A	Century	✓	\$1,239	E1	91.0	7.7	120	17.52		WD210TCDR	
	1800	230/460	213T	GT0016	213TTDB6026	✓	\$1,003	E1	91.0	19.0/9.5	160	17.52	d	A161	
	1800	230/460	213T	GT0016A	213TTDB6026	✓	\$1,003	E1	91.0	19.8/9.9	120	17.52		A161	
	1800	230/460	213T	TO125	Century	✓	\$1,176	E1	91.0	19.0/9.5	160	17.52	d	WD210TCDR	
	1800	230/460	213T	TO125A	Century	✓	\$1,176	E1	91.0	19.8/9.9	120	17.52		WD210TCDR	
	1800	575	213T	TO126	Century	✓	\$1,239	E1	91.0	7.6	128	17.52	d	WD210TCDR	
	1800	575	213T	TO126A	Century	✓	\$1,239	E1	91.0	7.6	120	17.52		WD210TCDR	
10	1200	230/460	254T	GT0017	254TTDCA6076	✓	\$1,583	E1	90.2	21.0/10.5	281	22.64	d	A163	
	1200	230/460	254T	GT0057	254TTDBD6076	✓	\$1,583	E1	90.2	20.2/10.1	225	22.64		A163A	
	3600	230/460	213T	GT0018	213TTDB6001	✓	\$1,145	E1	89.5	23.0/11.5	150	17.52	d	A161	
	3600	230/460	213T	GT0018A	213TTDB6001	✓	\$1,145	E1	89.5	23.6/11.8	135	18.35		A161	
	3600	230/460	213T	TO133	Century	✓	\$1,343	E1	89.5	23.0/11.5	150	17.52	d	WD210TCDR	
	3600	230/460	213T	TO133A	Century	✓	\$1,343	E1	89.5	23.6/11.8	135	18.35		WD210TCDR	
	1800	200	215T	TO132	Century	✓	\$1,462	E1	91.7	28.0	220	17.52	d	WD210TCDR	
	1800	200	215T	TO132A	Century	✓	\$1,462	E1	91.7	28.0	167	19.95		WD210TCDR	
	1800	230/460	215T	GT0019	215TTDB6026	✓	\$1,184	E1	91.7	25.0/12.5	220	17.52	d	A161	
	1800	230/460	215T	GT0019A	215TTDB6026	✓	\$1,184	E1	91.7	25.4/12.7	167	19.95		A161	
	1800	230/460	215T	TO130	Century	✓	\$1,388	E1	91.7	25.0/12.5	220	17.52	d	WD210TCDR	
	1800	230/460	215T	TO130A	Century	✓	\$1,388	E1	91.7	25.4/12.7	167	19.95		WD210TCDR	
15	1800	575	215T	TO131	Century	✓	\$1,462	E1	91.7	9.8	220	17.52	d	WD210TCDR	
	1800	575	215T	TO131A	Century	✓	\$1,462	E1	91.7	9.8	167	19.95		WD210TCDR	
	1200	230/460	256T	GT0020	256TTDCA6076	✓	\$1,973	E1	91.7	27.6/13.8	305	24.22	d	A163	
	1200	230/460	256T	GT0058	256TTDBD6076	✓	\$1,973	E1	91.7	25.6/12.8	278	24.22		A163A	
	3600	230/460	215T	GT0021	215TTDB6001	✓	\$1,678	E1	90.2	34.0/17.0	184	17.52	d	A161	
	3600	230/460	215T	GT0021A	215TTDB6001	✓	\$1,678	E1	90.2	36.0/18.0	95	19.95		A161	
	3600	230/460	215T	TO138	Century	✓	\$1,967	E1	90.2	34.0/17.0	184	17.52	d	WD210TCDR	
	3600	230/460	215T	TO138A	Century	✓	\$1,967	E1	90.2	36.0/18.0	95	19.95		WD210TCDR	
	1800	230/460	254T	GT0022	254TTDCA6026	✓	\$1,639	E1	93.0	38.0/19.0	310	22.64	d	A163	
	1800	230/460	254T	GT0059	254TTDBD6026	✓	\$1,639	E1	93.0	37.5/18.8	272	22.64		A163A	
	1200	230/460	284T	GT0023	284TTDCA6076	✓	\$2,598	E1	91.7	40.0/20.0	414	25.71	d, YD	A165	
	1200	230/460	284T	GT0060	284TTDBD6076	✓	\$2,598	E1	91.7	41.0/20.6	300	25.71	YD	A165A	
20	3600	230/460	254T	GT0024	254TTDCA6001	✓	\$1,933	E1	91.0	46.0/23.0	300	22.64	d, YD	A162	
	3600	230/460	254T	GT0061	254TTDBD6001	✓	\$1,933	E1	91.0	48.0/24.0	270	22.64		A162A	
	1800	230/460	256T	GT0025	256TTDCA6026	✓	\$2,029	E1	93.0	49.0/24.5	360	24.22	d, YD	A163	
	1800	230/460	256T	GT0062	256TTDBD6026	✓	\$2,029	E1	93.0	48.5/24.3	314	24.22		A163A	
	1200	230/460	286T	GT0026	286TTDCA6076	✓	\$3,165	E1	92.4	54.0/27.0	457	27.09	d, YD	A165	
	1200	230/460	286T	GT0063	286TTDBD6076	✓	\$3,165	E1	92.4	52.5/26.3	275	27.09	YD	A165A	
	1200	230/460	286T	TO139	Century	✓	\$3,712	E1	92.4	54.0/27.0	457	27.09	d, YD	WD280TCD	
	1200	230/460	286T	TO139RS	Century	✓	\$3,712	E1	92.4	52.5/26.3	275	27.09	YD	A165A	
	25	3600	230/460	256T	GT0027	256TTDCA6001	✓	\$2,461	E1	91.7	57.0/28.5	315	24.22	d, YD	A162
	3600	230/460	256T	GT0064	256TTDBD6001	✓	\$2,461	E1	91.7	59.5/29.7	275	24.22		A162A	
	1800	230/460	284T	GT0028	284TTDCA6026	✓	\$2,394	E1	93.6	62.0/31.0	424	25.71	d, YD	A165	
	1800	230/460	284T	GT0065	284TTDBD6026	✓	\$2,394	E1	93.6	62.0/31.0	280	25.71	YD	A165A	
1800	230/460	284TS	GT0066	284TSTDBD6026	✓	\$2,394	E1	93.6	62.0/31.0	280	24.34	YD	A165A		
1200	230/460	324T	GT0029	324TTDCA6076	✓	\$3,770	E1	93.0	68.0/34.0	695	28.55	d, YD	A167		
1200	230/460	324T	GT0068	324TTDBD6076	✓	\$3,770	E1	93.0	65.0/32.5	289	28.55	YD	A167A		
1200	230/460	324T	TO144	Century	✓	\$4,421	E1	93.0	68.0/34.0	695	28.55	d, YD	WD320TCD		
1200	230/460	324T	TO144RS	Century	✓	\$4,421	E1	93.0	65.0/32.5	289	28.55	YD	A167A		
30	3600	230/460	284TS	GT0030	284TSTDCA6001	✓	\$3,044	E1	91.7	68.0/34.0	396	24.41	d, YD	A164	
	3600	230/460	284TS	GT0069	284TSTDBD6001	✓	\$3,044	E1	91.7	71.5/35.5	289	24.34	YD	A164A	
	1800	230/460	286T	GT0031	286TTDCA6026	✓	\$2,763	E1	94.1	74.0/37.0	483	27.09	d, YD	A165	
	1800	230/460	286T	GT0067	286TTDBD6026	✓	\$2,763	E1	94.1	72.5/36.0	431	27.09	YD	A165A	
	1800	230/460	286TS	GT0070	286TSTDBD6026	✓	\$2,763	E1	94.1	72.5/36.0	431	25.72	YD	A165A	
	1200	230/460	326T	GT0032	326TTDCA6076	✓	\$4,419	E1	93.6	78.5/39.0	760	29.73	d, YD	A167	
	1200	230/460	326T	GT0071	326TTDBD6076	✓	\$4,419	E1	93.6	75.0/37.5	450	29.73	YD	A167A	
	1200	230/460	326T	TO149	Century	✓	\$5,182	E1	93.6	78.5/39.0	760	29.73	d, YD	WD320TCD	
	1200	230/460	326T	TO149RS	Century	✓	\$5,182	E1	93.6	75.0/37.5	450	29.73	YD	A167A	

Catalog numbers (Cat No.) highlighted in bold blue are premium efficient.

Blue shaded areas are cast iron frames.

Continued on next page.

GLOBETROTTER® GENERAL PURPOSE MOTORS

THREE PHASE, DRIPPROOF MOTORS

RIGID BASE

HP	RPM	VOLTS	FRAME	CAT. NO.	MODEL NO.	STOCK	LIST PRICE	MULT. SYMB.	NOM. EFF.	FL. AMPS	WT.	"C" DIM.	FOOT NOTES	C-FACE KITS
40	3600	230/460	286TS	GT0033	286TSTDCA6001	✓	\$3,664	E1	92.4	90.0/45.0	452	25.79	d, YD	A164A
	3600	230/460	286TS	GT0072	286TSTDDB6001	✓	\$3,664	E1	92.4	93.0/46.5	450	25.72	YD	A164A
1800	200	324T	TO155	Century®		✓	\$4,286	E1	94.1	108	581	28.55	d	WD320TCD
	1800	200	324T	TO155RS	Century	✓	\$4,286	E1	94.1	108	511	28.55		A167A
1800	230/460	324T	GT0034	324TTDCA6026		✓	\$3,471	E1	94.1	95.0/47.5	581	28.55	d, YD	A167
	1800	230/460	324T	GT0073	324TTDDB6026	✓	\$3,471	E1	94.1	95.5/48.0	511	28.55	YD	A167A
1800	230/460	324T	TO156	Century		✓	\$4,071	E1	94.1	95.0/47.5	581	28.55	d, YD	WD320TCD
	1800	230/460	324T	TO156RS	Century	✓	\$4,071	E1	94.1	95.5/48.0	511	28.55	YD	A167A
1800	230/460	324TS	GT0074	324TSTDDB6026		✓	\$3,471	E1	94.1	95.5/48.0	511	27.05	YD	A167A
	1800	575	324T	TO157	Century	✓	\$4,286	E1	94.1	37	581	28.55	d	WD320TCD
1800	575	324T	TO157RS	Century		✓	\$4,286	E1	94.1	37	511	28.55		A167A
	1200	230/460	364T	GT0035	364TTDCB6086	✓	\$5,671	E1	94.1	99.0/49.5	875	31.69	d, YD	A169
1200	230/460	364T	GT0075	364TTDDB6086		✓	\$5,671	E1	94.1	97/48.5	650	31.69	YD	A169A
	1200	230/460	364T	TO154	Century	✓	\$6,651	E1	94.1	99.0/49.5	875	31.69	d, YD	WD360TCD
1200	230/460	364T	TO154RS	Century		✓	\$6,651	E1	94.1	97/48.5	650	31.69	YD	A169A
	50	3600	230/460	324TS	GT0036	324TSTDCA6001	✓	\$4,466	E1	93.0	93.0/46.5	548	27.05	d, YD
3600	230/460	324TS	GT0076	324TSTDDB6001		✓	\$4,466	E1	93.0	115/57.5	411	27.05	YD	A166A
	3600	230/460	324TS	TO163	Century	✓	\$5,238	E1	93.0	93.0/46.5	548	27.05	d, YD	WD320TCD2
3600	230/460	324TS	TO163RS	Century		✓	\$5,238	E1	93.0	115/57.5	411	27.05	YD	A166A
	1800	200	326T	TO160	Century	✓	\$5,109	E1	94.5	136	710	29.73	d	WD320TCD
1800	200	326T	TO160RS	Century		✓	\$5,109	E1	94.5	136	571	29.73		A167A
	1800	230/460	326T	GT0037	326TTDCA6026	✓	\$4,138	E1	94.5	118/59.0	710	29.73	d, YD	A167
1800	230/460	326T	GT0077	326TTDDB6026		✓	\$4,138	E1	94.5	118/59.0	571	29.73	YD	A167A
	1800	230/460	326T	TO159	Century	✓	\$4,852	E1	94.5	118/59.0	710	29.73	d, YD	WD320TCD
1800	230/460	326T	TO159RS	Century		✓	\$4,852	E1	94.5	118/59.0	571	29.73	YD	A167A
	1800	230/460	326TS	GT0078	326TSTDDB6026	✓	\$4,138	E1	94.5	118/59.0	571	28.23	YD	A167A
1800	230/460	326TS	TO162	Century		✓	\$4,852	E1	94.5	118/59.0	710	29.73	d, YD	WD320TCD
	1800	230/460	326TS	TO162RS	Century	✓	\$4,852	E1	94.5	118/59.0	571	29.73	YD	A167A
1800	575	326T	TO161	Century		✓	\$5,109	E1	94.5	470	710	29.73	d	WD320TCD
	1800	575	326T	TO161RS	Century	✓	\$5,109	E1	94.5	470	571	29.73		A167A
1200	230/460	365T	GT0038	365TTDCB6086		✓	\$6,529	E1	94.1	122/61.0	930	33.27	d, YD	A169
	1200	230/460	365T	GT0079	365TTDDB6086	✓	\$6,529	E1	94.1	120/60.0	600	33.27	YD	A169A
1200	230/460	365T	TO158	Century		✓	\$7,657	E1	94.1	134-121/61.0	905	33.27		WD360TCD
	1200	230/460	365T	TO158RS	Century	✓	\$7,657	E1	94.1	134-121/61.0	600	33.27		A169A
60	3600	230/460	326TS	GT0039	326TSTDCA6001	✓	\$5,344	E1	93.6	134/67.0	590	28.23	d, YD	A166
	3600	230/460	326TS	GT0080	326TSTDDB6001	✓	\$5,344	E1	93.6	136/68.0	582	28.23	YD	A166A
3600	230/460	326TS	TO169	Century		✓	\$6,267	E1	93.6	147-133/67.0	720	28.23		WD320TCD2
	3600	230/460	326TS	TO169RS	Century	✓	\$6,267	E1	93.6	136/68.0	582	28.23		A166A
1800	200	364T	TO167	Century		✓	\$6,073	E1	95.0	160	895	31.69	d	WD360TCD
	1800	200	364T	TO167RS	Century	✓	\$6,073	E1	95.0	160	738	31.69		A169A
1800	230/460	364T	GT0040	364TTDCB6060		✓	\$4,919	E1	95.0	139/69.5	1005	31.69	d, YD	A169
	1800	230/460	364T	GT0081	364TTDDB6060	✓	\$4,919	E1	95.0	139/69.5	738	31.69	YD	A169A
1800	230/460	364T	TO165	Century		✓	\$5,769	E1	95.0	154-139/70.0	895	31.69		WD360TCD
	1800	230/460	364T	TO165RS	Century	✓	\$5,769	E1	95.0	153-139/69.5	738	31.69		A169A
1800	230/460	364TS	GT0095	364TSTDDB6060		✓	\$4,919	E1	95.0	139/69.5	836	29.57	d	A169
	1800	230/460	364TS	GT0082	364TSTDDB6060	✓	\$4,919	E1	95.0	139/69.5	738	29.57	YD	A169A
1800	230/460	364TS	TO166	Century		✓	\$5,769	E1	95.0	154-139/70.0	890	29.57		WD360TCD
	1800	230/460	364TS	TO166RS	Century	✓	\$5,769	E1	95.0	139/69.5	738	29.57		A169A
1800	575	364T	TO168	Century		✓	\$6,073	E1	95.0	56	895	31.69	d	WD360TCD
	1800	575	364T	TO168RS	Century	✓	\$6,073	E1	95.0	56	738	31.69		A168A
1200	230/460	404T	TO164	Century		✓	\$9,215	E1	94.5	143/72	1228	37.20	d	WD400TCD
	1200	230/460	404T	GT0041	404TTDC6086	✓	\$7,858	E1	94.5	144/72.0	975	37.20	d, YD	A415
1200	230/460	404T	GT0041A	404TTDCC6086		✓	\$7,858	E1	94.5	141/70.5	565	37.20	YD	A415A
	75	3600	230/460	364TS	TO175RS	Century	✓	\$8,280	E1	93.6	192-172/86	700	29.57	
3600	230/460	364TS	GT0083	364TSTDDB6001		✓	\$7,060	E1	93.6	172/86.0	706	29.57	YD	A168A
	3600	230/460	364TS	GT0042	364TSTDDB6001	✓	\$7,060	E1	93.6	166/83.0	937	29.57	d, YD	A168
3600	230/460	364TS	TO175	Century		✓	\$8,280	E1	93.6	184-167/83.0	1015	29.57		WD360TCD2
	1800	200	365T	TO173	Century	✓	\$7,274	E1	95.0	200	1030	33.27	d	WD360TCD
1800	200	365T	TO173RS	Century		✓	\$7,274	E1	95.0	200	849	33.27		A168A
	1800	230/460	365T	GT0043	365TTDCB6060	✓	\$5,891	E1	95.0	174/87.0	1030	33.27	d, YD	A168

Catalog numbers (Cat No.) highlighted in bold blue are premium efficient.

Blue shaded areas are cast iron frames.

Continued on next page.

GEN. PURPOSE THREE PHASE

GLOBETROTTER® GENERAL PURPOSE MOTORS

THREE PHASE, DRIPPROOF MOTORS

RIGID BASE

HP	RPM	VOLTS	FRAME	CAT. NO.	MODEL NO.	STOCK	LIST PRICE	MULT. SYMB.	NOM. EFF.	FL. AMPS	WT.	"C" DIM.	FOOT NOTES	C-FACE KITS	
75	1800	230/460	365T	GT0084	365TTDBD6060	✓	\$5,891	E1	95.0	172/86.0	849	33.27	YD	A168A	
	1800	230/460	365T	TO171	Century®	✓	\$6,909	E1	95.0	174/87.0	1030	33.27	d, YD	WD360TCD	
	1800	230/460	365T	TO171RS	Century	✓	\$6,909	E1	95.0	172/86.0	849	33.27	YD	A168A	
	1800	230/460	365TS	GT0094	365TSTDCB6060	✓	\$5,891	E1	95.0	174/87.0	1030	31.14	d, YD	A168A	
	1800	230/460	365TS	GT0085	365TSTDBD6060	✓	\$5,891	E1	95.0	172/86.0	835	31.14	YD	A168A	
	1800	230/460	365TS	TO172	Century	✓	\$6,909	E1	95.0	174/87.0	1030	31.14	d, YD	WD360TCD	
	1800	230/460	365TS	TO172RS	Century	✓	\$6,909	E1	95.0	172/86.0	835	31.14	YD	A168A	
	1800	575	365T	TO174	Century	✓	\$7,274	E1	95.0	70.0	1030	33.27	d	WD360TCD	
	1800	575	365T	TO174RS	Century	✓	\$7,274	E1	95.0	70.0	1012	33.27		A168A	
	1200	230/460	405T	TO170	Century	✓	\$11,326	E1	94.5	179/90.0	1333	38.78	d	WD400TCD	
	1200	230/460	405T	GT0044	405TTDC16081	✓	\$9,658	E1	94.5	180/90.0	1100	38.78	d, YD	A415	
	1200	230/460	405T	GT0044A	405TTDCD6081	✓	\$9,658	E1	94.5	174/87.0	620	38.78	YD	A415A	
	100	3600	230/460	365TS	TO181RS	Century	✓	\$10,133	E1	93.6	227/114	798	31.14	YD	A168A
		3600	230/460	365TS	GT0086	365TSTDBD6001	✓	\$8,640	E1	93.6	227/114	798	31.14	YD	A168A
		3600	230/460	365TS	TO181	Century	✓	\$10,133	E1	93.6	246-222/111	926	31.14	d	WD360TCD2
3600		230/460	365TS	GT0045	365TSTDCB6001	✓	\$8,640	E1	93.6	222/111	1016	31.14	d, YD	A168	
1800		200	404T	TO179	Century	✓	\$9,483	E1	95.4	251	2117	37.20	d	WD400TCD	
1800		230/460	404T	GT0046	404TTDC6060	✓	\$7,681	E1	95.4	226/113	1025	37.20	d, YD	A415	
1800		230/460	404T	TO177	Century	✓	\$9,008	E1	95.4	218/109	1280	37.20		WD400TCD	
1800		230/460	404T	GT0046A	404TTDCD6060	✓	\$7,681	E1	95.4	228/114	595	37.20	YD	A415A	
1800		230/460	404TS	GT0093	404TSTDC6060	✓	\$7,681	E1	95.4	226/113	1025	37.20	d, YD	A415	
1800		230/460	404TS	TO178	Century	✓	\$9,008	E1	95.4	223/112	1172	33.86		WD400TCD	
1800		230/460	404TS	GT0093A	404TSTDCD6060	✓	\$7,681	E1	95.4	228/114	585	33.86	YD	A415A	
1800		575	404T	TO180	Century	✓	\$9,483	E1	95.4	87	2117	37.2		WD400TCD	
1200		230/460	444T	GT0047	444TTDC16077	✓	\$11,989	E1	95.0	232/116	1675	44.57	d, YD	A417	
1200		230/460	444T	TO176	Century	✓	\$11,060	E1	95.0	232/116	1675	44.57		WD440TCD	
1200		230/460	444T	GT0047A	444TTDCD6077	✓	\$11,989	E1	95.0	232/116	1760	44.57	YD	A417A	
125	3600	230/460	404TS	TO186	Century	✓	\$12,122	E1	94.1	276/138	1172	33.86	d	WD400TCD2	
	3600	460	404TS	GT0048	404TSTDC6001	✓	\$10,336	E1	94.1	138	973	33.85	d, PW	A414	
	3600	460	404TS	GT0048A	404TSTDCD6001	✓	\$10,336	E1	94.1	139	540	33.86	PW	A414A	
	1800	230/460	405T	TO183	Century	✓	\$11,402	E1	95.4	279/139	1410	38.78	d	WD400TCD	
	1800	230/460	405T	GT0049	405TTDC6060	✓	\$9,723	E1	95.4	226/113	1025	37.20	d, YD	A415	
	1800	460	405T	GT0049A	405TTDCD6060	✓	\$9,723	E1	95.4	142	591	37.20	PW	A415A	
	1800	230/460	405TS	TO184	Century	✓	\$11,402	E1	95.4	279/139	1274	35.44		WD400TCD	
	1800	460	405TS	GT0088	405TSTDCD6060	✓	\$9,723	E1	95.4	142	591	35.44	PW	A415A	
	1800	575	405T	TO185	Century	✓	\$11,654	E1	95.4	112	1410	38.78		WD400TCD	
	1200	230/460	445T	TO182	Century	✓	\$18,451	E1	95.0	290/145	1867	44.57	d	WD440TCD	
	1200	460	445T	GT0050	445TTDC16076	✓	\$15,733	E1	95.0	145	1799	44.57	d, PW	A417	
	1200	460	445T	GT0050A	445TTDCD6076	✓	\$15,733	E1	95.0	145	865	44.57	PW	A417A	
	150	3600	230/460	405TS	TO191	Century	✓	\$14,185	E1	94.1	332/166	1274	35.44	d	WD400TCD2
		3600	460	405TS	GT0051	405TSTDC6007	✓	\$12,095	E1	94.1	164	1075	35.45	d, PW	A414
		3600	460	405TS	GT0051A	405TSTDCD6007	✓	\$12,095	E1	94.1	165	570	35.44	PW	A414A
1800		230/460	444T	TO189	Century	✓	\$15,308	E1	95.8	333/167	1904	44.57	d	WD440TCD	
1800		460	444T	GT0052	444TTDC6060	✓	\$13,053	E1	95.8	168	1275	44.57	d, PW	A417	
1800		460	444T	GT0052A	444TTDCD6060	✓	\$13,053	E1	95.8	168	880	44.57	PW	A417A	
1800		230/460	444TS	TO190	Century	✓	\$15,308	E1	95.8	333/167	1675	40.83	d	WD440TCD	
1800		460	444TS	GT0089	444TSTDCD6060	✓	\$13,053	E1	95.8	168	880	40.83	PW	A417A	
1800		575	444T	TO188	Century	✓	\$16,114	E1	95.8	133	1904	44.57		WD440TCD	
1200		230/460	447T	TO187	Century	✓	\$18,971	E1	95.4	342/171	2075	49.69	d	WD440TCD	
1200		460	447T	GT0053	447TTDC16077	✓	\$16,176	E1	95.4	172	2050	49.69	d, PW	A419	
1200		460	447T	GT0053A	447TTDCD6077	✓	\$16,176	E1	95.4	173	965	49.69	PW	A419A	
200		3600	460	444TS	TO196	Century	✓	\$22,064	E1	95.0	215	1277	40.83	d, PW	WD440TCD2
		3600	460	444TS	GT0054	444TSTDC16003	✓	\$18,814	E1	95.0	215	1277	40.83	d, PW	A416
		3600	460	444TS	GT0054A	444TSTDCD6003	✓	\$18,814	E1	95.0	215	885	40.83	PW	A416A
	1800	460	445T	TO193	Century	✓	\$19,207	E1	95.8	168	1275	44.57	d, PW	WD440TCD	
	1800	460	444T	GT0055	445TTDC6060	✓	\$16,378	E1	95.8	168	1275	44.57	d, PW	A417	
	1800	460	444T	GT0055A	445TTDCD6060	✓	\$16,378	E1	95.8	168	880	44.57	PW	A417A	
	1800	460	445TS	TO194	Century	✓	\$19,207	E1	95.8	168	880	40.83	d, PW	WD440TCD	
	1800	460	444TS	GT0090	445TSTDCD6060	✓	\$16,378	E1	95.8	168	880	40.83	PW	A417A	
	1800	575	445T	TO195	Century	✓	\$20,219	E1	95.8	178	2117	44.57		WD440TCD	
	1200	460	449T	TO192	Century	✓	\$24,190	E1	95.4	228	2200	49.69	d, PW	WD440TCD	
	1200	460	449T	GT0056	449TTDC16076	✓	\$20,626	E1	95.4	228	2200	49.69	d, PW	A419	
	1200	460	449T	GT0056A	449TTDCD6076	✓	\$20,626	E1	95.4	230	1874	49.69	PW	A419A	

Catalog numbers (Cat No.) highlighted in bold blue are premium efficient.
Blue shaded areas are cast iron frames.

Prices and specifications are subject to change without notice.

XRI® GENERAL PURPOSE MOTORS

THREE PHASE, TOTALLY ENCLOSED MOTORS

APPLICATIONS:

General purpose use on compressors, pumps, conveyors, blowers, and other machinery in dirty and dusty environments. Substantial energy savings can be realized when using these high efficiency motors. Guaranteed efficiencies offer an eXtra return on your investment when using these premium efficiency motors on high cycle or long run time applications.

FEATURES:

- Meets or exceeds NEMA Premium® efficiencies
- Suitable for use on a VFD. 10:1 variable torque and constant torque, as noted
- 1.15 service factor on sinewave (except as noted), 1.0 service factor on IGBT power
- Bearing Current Protection (BCP), as noted
- Frame constructions are heavy gauge steel, cast iron or aluminum, as noted
- Class F Insulation (except as noted)
- Ball bearings (except as noted)
- 60/50 hertz at next lower horsepower, as noted
- Motors accept C-Face kits, as noted
- Design B, except as noted
- Two year warranty on non bold catalog numbers
- Three year warranty on bold blue catalog numbers
- UL recognized, CSA certified, and CE mark



MODELS FROM 1 HP THROUGH 40 HP, CAST IRON FRAMES WITH CAT NO. HIGHLIGHTED IN BOLD BLUE ARE CAPABLE OF MODIFICATION AS FOLLOWS (CONTACT FACTORY TO CONFIRM):

- 1.25 service factor (sinewave only)
- 50Hz at same HP, 1.0 service factor (sinewave only)
- Certain combinations of existing and new nameplate markings are not possible (contact factory to confirm)
- Any nameplate changes are subject to modification charges (see MOD Central section)
- Contact your sales representative for optional nameplate markings on 50 HP and larger

RIGID BASE

HP	RPM	VOLTS	FRAME	CAT. NO.	MODEL NO.	STOCK	CT SPEED RANGE	LIST PRICE	MULT. SYMB.	NOM. EFF.	F.L. AMPS	WT.	"C" DIM.	FOOT NOTES	C FACE KITS
1/4	1800	208-230/460	48	K151	5K32GN30	√	—	\$352	F1	62.9	1.3-1.4/0.7	14	9.92	20	AG215
	1800	230/460	48	K194	5K33KN92	√	—	\$513	F1	67.5	1.2/0.6	15	9.19	17,N	AG215
	1800	575	48	K418	5K32GN53	√	—	\$477	F1	61.2	0.6	16	9.92	17	AG215
	1800	208-230/460	56	K439	5K49DN4131	√	—	\$513	F1	67.4	1.1-1.2/0.6	16	9.57	17,N	A536
	1200	230/460	56	K321	5K35MN75	√	—	\$505	F1	66.0	1.4/0.7	17	10.93	20,68	AG215
1/3	3600	208-230/460	48	K153	5K33FN30	√	—	\$352	F1	61.0	1.5-1.8/0.9	16	10.20	17	AG215
	1800	208-230/460	56	K154	5K49FN4136	√	—	\$381	F1	69.2	1.5-1.6/0.8	20	10.73	20,68	A536
	1800	208-230/460	56	K196	5K49FN4129	√	—	\$575	F1	73.4	1.3-1.4/0.7	18	9.57	17,N	A536
	1800	575	56	G304	056T17F2043	√	—	\$381	F1	65.5	0.6	25	10.22	25	N/A
	1200	230/460	56	K155	5K36PN30	√	—	\$536	F1	67.3	1.8/0.9	20	11.40	20,68	AG215
1/2	3600	208-230/460	56	G308	056T34F5328	√	2:1	\$346	F1	66.0	2.1-2.2/1.1	22	11.82	68	A437
	3600	575	56	G309	056T34F5333	√	2:1	\$346	F1	66.0	0.9	22	11.82		A437
	1800	208-230/460	56	K158	5K35MNB117	√	—	\$426	F1	76.1	2.1-2.2/1.1	17	10.93	19	AG215
	1800	208-230/460	56	K197	5K42HN4109	√	—	\$426	F1	76.9	1.8-1.8/0.9	20	9.95	17,N	A536
	1800	575	56	K426	5K42HN4134	√	—	\$426	F1	76.9	0.8	22	11.00	19,50	A536
	1200	208-230/460	56	K159	5K49MN6079	√	—	\$588	F1	72.0	2.6-2.6/1.3	27	11.43	5,19	A536

Continued on next page.

XRI® GENERAL PURPOSE MOTORS

THREE PHASE, TOTALLY ENCLOSED MOTORS

RIGID BASE

HP	RPM	VOLTS	FRAME	CAT. NO.	MODEL NO.	STOCK	CT SPEED RANGE	LIST PRICE	MULT. SYMB.	NOM. EFF.	FL. AMPS	WT.	"C" DIM.	FOOT NOTES	C FACE KITS	
3/4	3600	208-230/460	56	K160	5K37NN30	✓		\$413	F1	74.1	2.6-2.5/1.3	18	11.76	19	AG215	
	3600	575	56	G327	056T34F5334	✓	2:1	\$413	F1	74.0	1.3	23	11.82		A437	
	1800	200-208	56	G328	056T17F2045		—	\$470	F1	75.5	3.2/3.3	21	11.22	25	N/A	
	1800	208-230/460	56	K161	5K36PNB111	✓	—	\$470	F1	78.9	2.8-2.8/1.4	20	11.36	19	AG215	
	1800	208-230/460	56	K198	5K49PN4113	✓	—	\$470	F1	80.6	2.4-2.4/1.2	31	11.38	17,N	A536	
	1800	575	56	G1340	5K36PN251	✓	—	\$470	F1	73.4	1.3	20	11.40	19	AG215	
	1200	208-230/460	56	K162	5K46PN6082	✓	—	\$609	F1	76.1	2.9-2.8/1.4	31	11.83	68	A536	
	1200	208-230/460	143T	H700	143TTFR5376	✓	2:1	\$573	E6	74.0	3.2-3.2/1.6	28	12.37	68	A438	
1	1200	208-230/460	143T	H457	143TTFN8076	✓	2:1	\$573	E6	74.0	3.1-3.2/1.6	46	12.04	68	A603	
	3600	200	56	E2150	056T34F16001		10:1	\$675	F1	80.0	3.2	24	11.31		A437	
	3600	208-230/460	56	K163	5K38RN30	✓	—	\$464	F1	78.5	3.2-3.0/1.5	25	12.36	19, 68	AG215	
	3600	230/460	56	E2100	056T34F15940	✓	10:1	\$675	F1	80.0	2.8/1.4	24	11.31		A642	
	3600	575	56	E2125	056T34F16020		10:1	\$675	F1	80.0	1.1	24	11.31		A437	
	1800	208-230/460	56	G347	056T17F5302	✓	2:1	\$492	F1	77.0	3.5-3.6/1.8	25	12.32	d, 68	A437	
	1800	230/460	56	G347A	056T17F15666	✓	4:1	\$610	F1	85.5	3.3/1.7	42	14.62	68	A437	
	1800	575	56	G348A	056T17F15667	✓	4:1	\$610	F1	85.5	1.3	42	14.62		A437	
	1800	200	143T	E824	143TTFR4028	✓	10:1	\$553	E8	82.5	3.5	32	12.87	d	A438	
	1800	200	143T	E2151	143TTFR16038	✓	10:1	\$610	E9	85.5	3.7	32	13.75		A642	
	1800	200	143T	E825A	143TTTN16041		1000:1	\$698	E9	85.5	3.5	32	10.43	N	A603	
	1800	230/460	143T	E2101	143TTFR15642	✓	10:1	\$610	E9	85.5	3.2/1.6	32	13.75		A642	
	1800	208-230/460	143T	E826	143TTTC4026	✓	1000:1	\$583	E1	85.5	3.2-3.0/1.5	51	10.43	d, 68, N	A603	
	1800	230/460	143T	E349	143TTTN6026	✓	1000:1	\$698	E9	85.5	3.0/1.5	53	10.43	68, N	A603	
	1800	230/460	143T	E2201-P	143TTFN16040	✓	10:1	\$853	E9	85.5	3.0/1.5	48	13.99	P	A603	
	1800	575	143T	E2126	143TTFR16040	✓	10:1	\$610	E9	85.5	1.3	32	13.75		A642	
	1800	575	143T	E300	143TTTN6030		1000:1	\$698	E9	85.5	1.2	55	10.43	N	A603	
	1200	230/460	56H	G360A	056T11F15525	✓	4:1	\$717	F1	82.5	3.8/1.9	49	15.33	5, 68	A437	
	1200	200	145T	E2152	145TTFR16072		10:1	\$717	E9	82.5	4.4	42	13.75		A642	
	1200	230/460	145T	E2102	145TTFR16078		10:1	\$717	E9	82.5	3.8/1.9	42	13.75		A642	
	1200	230/460	145T	E350A	—		1000:1	\$790	E9	82.5	3.3/1.6	56	11.43	N, 68	A655	
	1200	230/460	145T	E355	145TTFN16081	✓	10:1	\$790	E9	82.5	3.6/1.8	54	13.99	68	A655	
	1200	575	145T	E2127	145TTFR16080		10:1	\$717	E9	82.5	1.5	42	13.75		A642	
	1200	575	145T	U672A	—		1000:1	\$790	E9	82.5	1.3	56	11.43	N	A655	
	1200	575	145T	U699	145TTFN16082	✓	10:1	\$790	E9	82.5	1.4	56	11.43		A655	
	900	230/460	182T	L409B	182TTFN16101	✓	10:1	\$1,124	E9	75.5	3.8/1.9	85	15.87	68	A641	
	1 1/2	3600	230/460	56	G383A	056T34F15636		4:1	\$720	F1	84.0	4.0/2.0	35	13.32	68	A437
		3600	575	56	G363A	056T34F15619		4:1	\$720	F1	84.0	1.6	37	13.32		A437
		3600	200	143T	E2153	143TTFR16001		10:1	\$720	E9	84.0	4.6	37	13.75		A642
		3600	200	143T	E831A	—		1000:1	\$803	E9	84.0	4.6	59	11.43	N	A603
		3600	200	143T	E356	143TTFN16008		10:1	\$803	E9	84.0	4.6	62	13.75		A603
		3600	230/460	143T	E2103	143TTFR15582	✓	10:1	\$720	E9	84.0	4.0/2.0	37	13.75		A642
3600		230/460	143T	E351	143TTTN6001	✓	1000:1	\$803	E9	86.5	4.0/2.0	54	10.43	N	A603	
3600		575	143T	E2128	143TTFR16020		10:1	\$720	E9	84.0	1.6	37	13.75		A642	
3600		575	143T	E835	143TTTN4005		1000:1	\$615	E1	86.5	1.6	42	10.43	d,N	A603	
1800		230/460	56H	G365A	056T17F15668	✓	4:1	\$709	F1	86.5	4.6/2.3	48	14.83	68	A437	
1800		200	145T	E836	145TTFR4029	✓	10:1	\$617	E8	84.0	5.1	44	14.37	d	A438	
1800		200	145T	E2154	145TTFR16038	✓	10:1	\$709	E9	86.5	5.2	34	13.75		A642	
1800		200	145T	U601A	145TTTN16045		1000:1	\$751	E9	86.5	5.3	58	11.43	N	A655	
1800		208-230/460	145T	E837	145TTTC4026	✓	1000:1	\$647	E1	84.0	4.6-4.2/2.1	58	11.43	d,68,N	A655	
1800		208-230/460	145T	E352A	—		1000:1	\$751	E9	86.5	4.4/2.2	62	11.43	N	A655	
1800		230/460	145T	E2104	145TTFR16033	✓	10:1	\$709	E9	86.5	4.8/2.4	34	13.75		A642	
1800		230/460	145T	E2204-P	145TTFN16046	✓	10:1	\$900	E9	86.5	4.6/2.3	54	13.99	P	A603	
1800		575	145T	E2129	145TTFR16040	✓	10:1	\$709	E9	86.5	1.9	34	13.75		A642	
1800		575	145T	E839	145TTTN4035	✓	1000:1	\$647	E1	84.0	1.8	62	11.43	d,N	A655	
1800		575	145T	E301A	145TTTN16038	✓	1000:1	\$751	E9	86.5	1.9	59	11.43	N	A655	
1200		200	182T	E2155	182TTFW16072		10:1	\$888	E9	87.5	6.4	89	15.96	13	A666	
1200		230/460	182T	E2105	182TTFW16076	✓	10:1	\$888	E9	87.5	5.6/2.8	89	15.96	13	A666	
1200		575	182T	E2130	182TTFW16080		10:1	\$888	E9	87.5	2.2	89	15.96	13	A666	
900		230/460	184T	L410A	184TTFS14101	✓	10:1	\$1,095	E8	78.5	6.1/3.05	99	15.81	d,68	A644	
900	230/460	184T	L410C	184TTFN16105	✓	10:1	\$1,208	E9	80.0	6.0/3.0	149	17.87	68	A641		

Catalog numbers (Cat No.) highlighted in bold blue are premium efficient.

Blue shaded areas are cast iron frames.

Continued on next page.

XRI® GENERAL PURPOSE MOTORS

THREE PHASE, TOTALLY ENCLOSED MOTORS

RIGID BASE

HP	RPM	VOLTS	FRAME	CAT. NO.	MODEL NO.	STOCK	CT SPEED RANGE	LIST PRICE	MULT. SYMB.	NOM. EFF.	FL. AMPS	WT.	"C" DIM.	FOOT NOTES	C FACE KITS
2	3600	200	145T	E2156	145TTFR16001		10:1	\$781	E9	85.5	5.5	44	13.75		A642
	3600	200	145T	E841A	—		1000:1	\$818	E9	85.5	5.3	64	11.43	N	A655
	3600	230/460	145T	E2106	145TTFR13002	✓	10:1	\$781	E9	85.5	4.8/2.4	44	13.75		A642
	3600	208-230/460	145T	E842	145TTTN4001	✓	1000:1	\$712	E1	84.0	5.8-5.4/2.7	66	11.43	d, 68, N	A655
	3600	230/460	145T	E353	145TTTN6001	✓	1000:1	\$818	E9	85.5	5.0/2.5	64	11.43	N, NE	A603
	3600	575	56H	G368A	056T34F15623		4:1	\$781	F1	85.5	2.0	29	14.32		A437
	3600	575	145T	E844	145TTTN4005		1000:1	\$712	E9	86.5	2.1	66	11.43	d, N	A655
	3600	575	145T	E2131	145TTFR16020		10:1	\$781	E9	85.5	1.9	44	13.75		A642
	1800	208-230/460	56	G369A	056T17F15669	✓	4:1	\$723	F1	86.5	6.0/3.0	48	15.33	5, 68	A536
	1800	200	145T	E2157	145TTFR16039	✓	10:1	\$723	E9	86.5	6.7	50	14.25		A642
	1800	200	145T	U606A	145TTTN16039		1000:1	\$809	E9	86.5	6.9	61	11.43	N	A655
	1800	230/460	145T	E2107	145TTFR16035	✓	10:1	\$723	E9	86.5	5.8/2.9	50	14.25		A642
	1800	208-230/460	145T	E354A	—		1000:1	\$809	E9	86.5	6.0/3.0	68	11.43	N	A655
	1800	230/460	145T	E2207-P	145TTFN16045	✓	10:1	\$940	E9	86.5	6.0/3.0	64	13.99	P	A603
	1800	575	145T	E2132	145TTFR16045	✓	10:1	\$723	E9	86.5	2.3	50	14.25		A642
	1800	575	145T	E302A	145TTTN16037	✓	1000:1	\$809	E9	86.5	2.4	66	12.68	N	A655
	1200	200	184T	E2158	184TTFW16079		10:1	\$1,040	E9	88.7	7.4	89	14.97	13	A666
	1200	230/460	184T	E2108	184TTFW16076	✓	10:1	\$1,040	E9	88.7	7.2/3.6	89	14.97	13	A666
	1200	575	184T	E2133	184TTFW16081		10:1	\$1,040	E9	88.7	2.9	89	14.97	13	A666
	900	230/460	213T	L411B	213TTFN16101	✓	10:1	\$1,710	E9	86.5	8.0/4.0	226	19.63	68	A646
3	3600	200	182T	E2159	182TTFW16002		10:1	\$916	E9	86.5	8.7	66	13.97	13	A666
	3600	575	182T	E2134	182TTFW16020		10:1	\$916	E9	86.5	3.0	66	13.97	13	A666
	3600	230/460	182T	E2109	182TTFW16001	✓	10:1	\$916	E9	86.5	7.6/3.8	66	13.97	13	A666
	3600	230/460	182T	E216	182TTTS6001		20:1	\$1,030	E9	89.5	7.6/3.8	94	12.71	N	A644
	1800	200	182T	E2160	182TTFW16038	✓	10:1	\$900	E9	89.5	9.0	80	14.97	13	A666
	1800	575	182T	E2135	182TTFW16040	✓	10:1	\$900	E9	89.5	3.1	80	14.97	13	A666
	1800	575	182T	U609A	182TTFC6031	✓	10:1	\$934	E9	89.5	3.2	104	15.89	d	N/A
	1800	575	182T	E303	182TTTS6030		1000:1	\$951	E9	90.2	3.2	100	12.71	N	A644
	1800	230/460	182T	E2110	182TTFW16026	✓	10:1	\$900	E9	89.5	7.8/3.9	80	14.97	13	A666
	1800	230/460	182T	E2210-P	182TTFN16047	✓	10:1	\$1,136	E9	89.5	8.0/4.0	104	15.87	P	A644
	1200	200	213T	E2161	213TTFW16082		10:1	\$1,283	E9	89.5	10.1	115	18.73		A609
	1200	575	213T	E2136	213TTFW16081		10:1	\$1,283	E9	89.5	3.5	115	18.73		A609
	1200	230/460	213T	E2111	213TTFW16076	✓	10:1	\$1,283	E9	89.5	8.8/4.4	115	18.73	d	A609
	1200	208-230/460	213T	E2111A	213TTFWD16076	✓	10:1	\$1,283	E9	89.5	9.2-8.8/4.4	107	18.73	68	A609
	900	230/460	215T	L421B	215TTFN16101	✓	10:1	\$2,220	E9	86.5	10.0/5.0	243	22.63	68	A646
	5	3600	200	184T	E2162	184TTFW16002		10:1	\$1,103	E9	88.5	13.8	96	16.47	13
3600		230/460	184T	E2112	184TTFW16001	✓	10:1	\$1,103	E9	88.5	12.0/6.0	96	16.47	13	A666
3600		575	184T	E2137	184TTFW16020		10:1	\$1,103	E9	88.5	4.8	96	16.47	13	A666
1800		200	184T	E2163	184TTFW16038	✓	10:1	\$1,013	E9	89.5	14.7	94	15.97	13	A666
1800		230/460	184T	E2113	184TTFW16026	✓	10:1	\$1,013	E9	89.5	12.8/6.4	94	15.97	13	A666
1800		208-230/460	184T	U618A	184TTFC6027	✓	10:1	\$1,091	E9	89.5	14.0-12.8/6.4	109	16.80	d	N/A
1800		230/460	184T	E202-P	184TTFN16056	✓	10:1	\$1,254	E9	89.5	12.4/6.2	109	17.85	P	A644
1800		575	184T	E2138	184TTFW16040	✓	10:1	\$1,013	E9	89.5	5.1	94	15.97	13	A666
1200		200	215T	E2164	215TTFW16072		10:1	\$1,658	E9	90.2	16.1	135	20.97		A609
1200		230/460	215T	E2114	215TTFW16076	✓	10:1	\$1,658	E9	90.2	14.0/7.0	135	20.97	d	A609
1200		230/460	215T	E2114A	215TTFWD16076	✓	10:1	\$1,658	E9	90.2	14.0/7.0	135	20.23	68	A609
1200		208-230/460	215T	U621A	215TTFC6077	✓	10:1	\$1,658	E9	90.2	15.8-14.4/7.2	176	19.61	d	N/A
1200		575	215T	E2139	215TTFW16080		10:1	\$1,658	E9	90.2	5.6	135	20.97		A609
900		230/460	254T	L412A	254TTFNA14103	✓	10:1	\$2,766	E8	87.5	15.0/7.5	534	23.52	68	A239

Catalog numbers (Cat No.) highlighted in bold blue are premium efficient.
Blue shaded areas are cast iron frames.

Continued on next page.

GEN. PURPOSE THREE PHASE

XRI® GENERAL PURPOSE MOTORS

THREE PHASE, TOTALLY ENCLOSED MOTORS

RIGID BASE

HP	RPM	VOLTS	FRAME	CAT. NO.	MODEL NO.	STOCK	CT SPEED RANGE	LIST PRICE	MULT. SYMB.	NOM. EFF.	FL. AMPS	WT.	"C" DIM.	FOOT NOTES	C FACE KITS
7 1/2	3600	200	213T	U622A	213TTFW16011		10:1	\$1,333	E9	90.2	20.5	137	20.23		A609
	3600	230/460	213T	E2115	213TTFW16001	✓	10:1	\$1,333	E9	90.2	17.8/8.9	116	20.97	d	A609
	3600	230/460	213T	E2115A	213TTFWD16001	✓	10:1	\$1,333	E9	89.5	19.7-18.6/9.3	75	18.73		A609
	3600	230/460	213T	E218	213TTTS6001		2:1	\$1,480	E9	90.2	17.8/8.9	185	15.69	N	A206
	3600	575	213T	E2140	213TTFW16020		10:1	\$1,333	E9	90.2	7.1	116	20.97		A609
	3600	575	213T	U671A	213TTFWC6006	✓	10:1	\$1,480	E9	90.2	7.3	147	18.19	d	N/A
	1800	200	213T	U627A	213TTFW16048	✓	10:1	\$1,250	E9	91.7	22.1	144	20.23		A667
	1800	230/460	213T	E2116	213TTFW16026	✓	10:1	\$1,250	E9	91.7	21.6/10.8	144	18.70	d	A667
	1800	208-230/460	213T	E2116A	213TTFWD16026	✓	10:1	\$1,250	E9	91.7	20.8-19.6/9.8	126	18.73	68	A667
	1800	208-230/460	213T	U629A	213TTFWC6027	✓	10:1	\$1,343	E9	91.7	20.5-18.6/9.3	155	18.19	d	N/A
	1800	230/460	213T	E203-P	213TTFN16326	✓	10:1	\$1,543	E9	91.7	20.0/10.0	185	19.63	d, P	A646
	1800	230/460	213T	E203A-P	213TTFND16326	✓	10:1	\$1,543	E9	91.7	19.2/9.6	220	19.63	P, 68	A646
	1800	575	213T	E2141	213TTFW16040	✓	10:1	\$1,250	E9	91.7	8.6	144	18.70		A667
	1200	230/460	254T	E2117	254TTF16076	✓	10:1	\$2,180	E9	91.0	19.5/9.75	162	22.99	AL	A1209
	1200	230/460	254T	E235	254TTFNA6076		20:1	\$2,340	E9	91.0	19.8/9.9	223	23.52		A284
	1200	208-230/460	254T	U633A	254TTFWC6077	✓	10:1	\$2,215	E9	91.0	24.2-22.2/11.1	249	23.19	d	N/A
	1200	575	254T	E2142	254TTF16080		10:1	\$2,180	E9	91.0	8.2	162	22.99	AL	A1209
	1200	575	254T	E005	254TTFWC6081	✓	10:1	\$2,215	E9	91.0	8.5	249	23.19	d	N/A
	900	230/460	256T	L413A	256TTFNA14101	✓	10:1	\$3,520	E8	86.2	23.0/11.5	312	25.27	d, 68	A239
	900	230/460	256T	L413B	256TTFNA16101	✓	10:1	\$3,790	E9	86.5	22.0/11.0	342	25.27	68	A239
10	3600	200	215T	U634A	—		10:1	\$1,470	E9	90.2	27.6	152	20.23		A609
	3600	575	215T	U637	215TTF4005		2:1	\$1,514	E1	90.2	9.6	184	19.70	d	A206
	3600	230/460	215T	E2118	215TTFW16001	✓	10:1	\$1,495	E9	90.2	23.6/11.8	137	22.22		A609
	3600	230/460	215T	E2118A	215TTFWD16001	✓	10:1	\$1,495	E9	90.2	23.6/11.8	137	22.22		A609
	3600	575	215T	E2143	215TTFW16020		10:1	\$1,495	E9	90.2	9.4	137	22.22		A609
	3600	208-230/460	215T	U636A	215TTFWC6002	✓	10:1	\$1,512	E9	90.0	25.7-23.4/11.7	181	19.61	d	N/A
	1800	200	215T	E822A	215TTFWD16052	✓	10:1	\$1,450	E9	91.7	30.5	125	20.23		A609
	1800	230/460	215T	E2119	215TTFW16026	✓	10:1	\$1,450	E9	91.7	26.8/13.4	161	19.70		A667
	1800	230/460	215T	E2119A	215TTFWD16026	✓	10:1	\$1,450	E9	91.7	26.8/13.4	161	19.70		A667
	1800	575	215T	E2144	215TTFW16040	✓	10:1	\$1,450	E9	91.7	10.7	161	19.70		A667
	1800	208-230/460	215T	U639A	215TTFWC6027	✓	10:1	\$1,488	E9	91.7	27.5-25.0/12.5	177	19.61	d	N/A
	1800	575	215T	U641A	215TTFWC6031	✓	10:1	\$1,488	E9	91.7	10.3	177	19.61	d	N/A
	1800	575	215T	E306	215TTF40030		20:1	\$1,488	E9	91.7	10.0	225	19.70		A206
	1800	230/460	215T	E204-P	215TTFN16057	✓	10:1	\$1,844	E9	91.7	25.0/12.5	177	22.63	P	A646
	1800	230/460	215T	E204A-P	215TTFN16057	✓	10:1	\$1,844	E9	91.7	25.0/12.5	177	22.63	P	A646
	1200	230/460	256T	E2120	256TTF16076	✓	10:1	\$2,691	E9	91.0	26.2/13.1	185	25.15	AL	A1209
	1200	575	256T	E2145	256TTF16077		10:1	\$2,691	E9	91.0	10.5	185	25.15	AL	A1209
	1200	208-230/460	256T	U642A	256TTFWC6077	✓	10:1	\$2,859	E9	91.0	32.4-29.9/14.5	300	24.92	d	N/A
	1200	230/460	256T	E236	256TTFNA6076		20:1	\$2,859	E9	91.0	26.2/13.1	368	25.27		A284
	900	230/460	284T	L414A	284TTFNA14102	✓	10:1	\$4,171	E8	89.5	31.0/15.5	388	26.26	68	A618
15	3600	200	254T	U643A	254TTF16006		10:1	\$1,973	E9	91.7	40.5	160	23.51	AL	A1209
	3600	230/460	254T	E2121	254TTF16001	✓	10:1	\$1,973	E9	91.7	35.4/17.7	162	22.99	AL	A1209
	3600	230/460	254T	E220	254TTFNA6001	✓	2:1	\$2,229	E9	91.7	35.0/17.5	350	23.52		A284
	3600	575	254T	E2146	254TTF16020		10:1	\$1,973	E9	91.7	14.2	162	22.99	AL	A1209
	3600	575	254T	U638A	254TTFWC6006	✓	10:1	\$2,069	E9	92.4	14.3	200	19.61	d	N/A
	1800	200	254T	U646B	254TTF16038	✓	10:1	\$1,923	E9	92.4	43.5	233	23.51	AL	A1209
	1800	230/460	254T	E2122	254TTF16026	✓	10:1	\$1,923	E9	92.4	38.1/19.1	174	22.99	AL	A1209
	1800	575	254T	E2147	254TTF16040	✓	10:1	\$1,923	E9	92.4	15.8	174	22.99	AL	A1209
	1800	230/460	254T	E2122-P	254TTF16036	✓	10:1	\$2,319	E9	92.4	38.1/19.1	174	22.99	P, AL	A1209
	1800	208-230/460	254T	U647B	254TTFWC6027	✓	10:1	\$2,130	E9	92.4	39.6-36.0/18.0	280	23.19		N/A
	1800	230/460	254T	E205	254TTFNA6026	✓	20:1	\$2,130	E9	92.4	37.5/18.8	350	23.52		A284
	1800	575	254T	E307	254TTFNA6030		20:1	\$2,130	E9	92.4	15.1	350	23.52		A284
	1800	230/460	254T	E205-P	254TTFNA16074	✓	20:1	\$2,444	E9	92.4	37.5/18.8	350	23.52	P	A284
	1200	208-230/460	284T	E978A	284TTFWC6077	✓	10:1	\$3,305	E9	91.7	44.7-40.6/20.3	333	26.26		N/A
	1200	230/460	284T	E237	284TTFNA6076	✓	20:1	\$3,607	E9	91.7	40.8/20.4	475	26.34		A618
	900	230/460	286T	L415B	286TTFNA16106	✓	10:1	\$5,734	E9	90.2	44.0/22.0	477	28.16	68	A617

Catalog numbers (Cat No.) highlighted in bold blue are premium efficient.

Blue shaded areas are cast iron frames.

Continued on next page.

XRI® GENERAL PURPOSE MOTORS

THREE PHASE, TOTALLY ENCLOSED MOTORS

RIGID BASE

HP	RPM	VOLTS	FRAME	CAT. NO.	MODEL NO.	STOCK	CT SPEED RANGE	LIST PRICE	MULT. SYMB.	NOM. EFF.	FL. AMPS	WT.	"C" DIM.	FOOT NOTES	C FACE KITS
20	3600	230/460	256T	E2123	256TTFL16002	✓	10:1	\$2,479	E9	91.0	47.0/23.5	186	24.74	AL	A1209
	3600	208-230/460	256T	U649A	256TTFC6002	✓	10:1	\$2,939	E9	91.0	50.6-46.0/23.0	316	24.92	d	N/A
	3600	230/460	256T	E221	256TTFNA6001		2:1	\$2,939	E9	91.0	46.8/23.4	375	25.27		A284
	3600	575	256T	E2148	256TTFL16020		10:1	\$2,479	E9	91.0	18.9	186	26.24	AL	A1209
	1800	200	256T	U651A	256TTFL16039		10:1	\$2,419	E9	93.0	55.5	191	25.26	AL	A1209
	1800	230/460	256T	E2124	256TTFL16033	✓	10:1	\$2,419	E9	93.0	48.6/24.3	191	26.24	AL	A1209
	1800	230/460	256T	E2124-P	256TTFL16038	✓	10:1	\$2,551	E9	93.0	48.6/24.3	191	26.24	P, AL	A1209
	1800	208-230/460	256T	U652B	256TTFC6027	✓	10:1	\$2,555	E9	93.0	53.9-49.0/24.5	322	24.92		N/A
	1800	230/460	256T	E206	256TTFNA6026	✓	20:1	\$2,654	E9	93.0	48.2/24.1	425	25.27		A284
	1800	230/460	256T	E206-P	256TTFNA16070	✓	20:1	\$3,051	E9	93.0	48.2/24.1	425	25.27	P	A284
	1800	575	256T	E2149	256TTFL16040	✓	10:1	\$2,419	E9	93.0	20.4	191	26.24	AL	A1209
	1800	575	256T	E308	256TTFNA6030		20:1	\$2,654	E9	93.0	19.3	425	25.27		A284
	1200	230/460	286T	E238	286TTFNA6076	✓	20:1	\$4,270	E9	91.7	53.6/26.8	550	27.84		A618
	900	230/460	324T	L416A	324TTFS14101	✓	4:1	\$7,128	E8	87.5	64.0/32.0	512	28.97	d, 68	A619
	900	230/460	324T	L416B	324TTFS16105	✓	4:1	\$8,180	E9	90.2	59.0/29.5	644	30.38	68	A619
25	3600	230/460	284TS	E222	284TSTFNA6001	✓	2:1	\$3,464	E9	93.6	56.2/28.1	475	24.97		A618
	1800	200	284T	U655	284TTFPA4028	✓	10:1	\$3,030	E1	92.4	71.0	374	31.87	d	A617
	1800	200	284T	U655A	284TTFNA16129		10:1	\$3,160	E9	93.6	72.5	500	26.66		A617
	1800	208-230/460	284TS	E999A	284TSTFC6036	✓	10:1	\$3,006	E9	93.6	64.9-59.0/29.5	385	26.26	d	N/A
	1800	230/460	284T	E207	284TTFNA6026	✓	20:1	\$3,160	E9	93.6	62.0/31.0	500	26.34		A618
	1800	230/460	284T	E207-P	284TTFNA16070	✓	20:1	\$3,623	E9	93.6	62.0/31.0	500	26.34	P	A618
	1800	575	284T	E309	284TTFNA6030	✓	20:1	\$3,160	E9	93.6	24.8	500	26.34		A618
	1200	230/460	324T	E239	324TTFS6076	✓	20:1	\$5,461	E9	93.0	65.0/32.5	675	28.87		A214
	900	230/460	326T	L417B	326TTFS16102	✓	10:1	\$8,421	E9	90.2	73.0/36.5	672	30.38	68	A214
	30	3600	230/460	286TS	E223	286TSTFNA6001	✓	2:1	\$3,880	E9	93.6	67.6/33.8	500	26.47	
3600		575	286TS	E819	286TSTFPA4005		2:1	\$3,675	E1	91.0	28.8	406	26.30	d	A617
1800		208-230/460	286T	E983B	286TTFC6027	✓	10:1	\$3,675	E9	93.6	77.0/70.0/35.0	432	27.83	d	N/A
1800		230/460	286T	E208	286TTFNA6026	✓	20:1	\$3,675	E9	94.1	73.0/36.5	525	27.84		A618
1800		208-230/460	286TS	E818A	286TSTFC6036	✓	10:1	\$3,525	E9	93.6	77.0/70.0/35.0	432	27.83	d	N/A
1800		230/460	286T	E208-P	286TTFNA16328	✓	20:1	\$4,225	E9	94.1	73.0/36.5	525	27.84	P	A618
1800		575	286T	E310	286TTFNA6030	✓	20:1	\$3,675	E9	94.1	29.2	525	27.84		A618
1800		575	286T	E817A	286TTFC6031	✓	10:1	\$3,525	E9	93.6	29.7	432	27.83	d	N/A
1200		230/460	326T	E240	326TTFS6076	✓	20:1	\$6,141	E9	93.0	77.0/38.5	725	30.37		A214
900		460	364T	L420	364TTFS8101	✓	2:1	\$9,569	E6	91.0	41.0	886	31.50	d, 68, 89	A395
900		460	364T	L420A	364TTFS16104	✓	4:1	\$10,401	E9	91.7	40.5	878	31.51	68, 89	A395
40		3600	230/460	324TS	E224	324TSTFS6001	✓	2:1	\$5,334	E9	93.6	94.0/47.0	675	27.37	
	3600	575	324TS	E319	324TSTFS6005		2:1	\$5,334	E9	94.1	37.5	675	27.37		A214
	1800	230/460	324T	E209	324TTFS6026	✓	20:1	\$4,881	E9	94.1	95.0/47.5	528	30.37		A214
	1800	208-230/460	324TS	E816A	324TSTFC6036	✓	10:1	\$4,881	E9	94.1	101-92.0/46.0	598	29.53	d	N/A
	1800	230/460	324T	E209-P	324TTFS16066	✓	20:1	\$5,630	E9	94.1	95.0/47.5	528	30.37	P	A214
	1800	575	324T	E311	324TTFS6030	✓	20:1	\$4,881	E9	94.1	39.0	528	30.37		A214
	1200	230/460	364T	E241A	364TTFS16083	✓	10:1	\$8,615	E9	94.1	100/50.0	950	31.50		A395
	900	460	365T	L425	365TTFS8115	✓	2:1	\$11,359	E6	91.0	53.5	970	32.50	d, 68, 89	A395
	900	460	365T	L425A	365TTFS16103	✓	2:1	\$12,170	E9	91.7	53.0	950	32.51	68, 89	A395
	50	3600	230/460	326TS	E225	326TSTFS6001	✓	2:1	\$6,719	E9	93.6	116/58.0	725	28.87	
3600		575	326TS	E320	326TSTFS6005		2:1	\$6,719	E9	94.5	46.5	725	28.87		A214
1800		230/460	326T	E210	326TTFS6026	✓	2:1	\$5,995	E9	94.5	120/60.0	775	31.87		A214
1800		208-230/460	326TS	E801A	326TSTFC6036	✓	10:1	\$5,995	E9	94.5	129-117/58.5	681	29.53	d	N/A
1800		230/460	326T	E210-P	326TTFS16073	✓	2:1	\$6,894	E9	94.5	120/60.0	775	31.87	P	A214
1800		575	326T	E312	326TTFS6030	✓	2:1	\$5,995	E9	94.5	48.0	775	31.87		A214
1200		208-230/460	365T	E993A	365TTFC6087	✓	10:1	\$9,091	E9	94.1	136-124/62	672	33.62	d	N/A
1200		230/460	365T	E242A	365TTFS16083	✓	4:1	\$9,547	E9	94.1	123/61.5	1000	32.50	68	A395
900		460	404T	L426	404TTFS8102	✓	10:1	\$12,486	E6	91.4	69.0	1191	35.62	d, 68, 89	A223
900		460	404T	L426A	404TTFS16103	✓	2:1	\$13,297	E9	93.6	66.0	1156	37.13	68, 89	A223

Catalog numbers (Cat No.) highlighted in bold blue are premium efficient.

Blue shaded areas are cast iron frames.

Continued on next page.

XRI® GENERAL PURPOSE MOTORS

THREE PHASE, TOTALLY ENCLOSED MOTORS

RIGID BASE

HP	RPM	VOLTS	FRAME	CAT. NO.	MODEL NO.	STOCK	CT SPEED RANGE	LIST PRICE	MULT. SYMB.	NOM. EFF.	FL. AMPS	WT.	"C" DIM.	FOOT NOTES	C FACE KITS	
60	3600	230/460	364TS	E226	364TSTFS6001	✓	2:1	\$8,462	E9	94.5	134/67.0	925	29.38		A396	
	3600	575	364TS	E321	364TSTFS6005		2:1	\$8,462	E9	94.5	53.5	925	29.38		A396	
	1800	230/460	364T	E211	364TTFS6036	✓	2:1	\$8,080	E9	95.0	138/69.0	1000	31.50		A395	
	1800	575	364T	E313	364TTFS6040	✓	2:1	\$8,080	E9	95.0	55.0	1000	31.50		A395	
	1200	230/460	404T	E243	404TTFS6086	✓	2:1	\$10,399	E9	94.5	144/72.0	1200	35.62		A223	
900	460	405T	L427A	405TTFS16103	✓	2:1	\$15,020	E9	93.6	80.0	1900	37.14	68, 89	A223		
75	3600	208-230/460	365TS	E991A	365TSTFC6003	✓	10:1	\$10,220	E9	93.6	186-169/84.5	780	31.50	d	N/A	
	3600	230/460	365TS	E227	365TSTFS6001	✓	2:1	\$10,858	E9	94.5	168/84.0	1025	30.38		A396	
	3600	575	365TS	E322	365TSTFS6002		2:1	\$10,858	E9	94.5	67.0	1025	30.38		A396	
	1800	230/460	365T	E212	365TTFS6036	✓	2:1	\$10,460	E9	95.4	172/86.0	1100	32.50		A395	
	1800	208-230/460	365TS	E804A	365TSTFC6026	✓	10:1	\$9,802	E9	95.8	188-171/85.5	1014	33.62	d	N/A	
	1800	575	365T	E315	365TTFS6040	✓	2:1	\$10,460	E9	95.4	69.0	1100	32.50		A395	
	1200	230/460	405T	E244	405TTFS6086	✓	2:1	\$13,086	E9	94.5	180/90.0	1300	37.12		A223	
	900	460	444T	L428A	444TTFN16102	✓	2:1	\$19,681	E9	93.6	102.0	2087	41.34	68, 89	A229	
	100	3600	230/460	405TS	E228	405TSTFS6001	✓	2:1	\$14,894	E9	95.0	216/108	1250	34.13		A226
3600		575	405TS	E323	405TSTFS6005		2:1	\$14,894	E9	95.0	86.5	1250	34.13		A226	
1800		230/460	405T	E213	405TTFS6036	✓	2:1	\$13,470	E9	95.4	226/113	1220	37.12		A223	
1800		230/460	405TS	E808A	405TSTFS16033	✓	2:1	\$13,470	E9	95.4	226/113	1220	34.13		A226	
1800		575	405T	E314	405TTFS6040	✓	2:1	\$13,470	E9	95.4	90.5	1220	37.12		A223	
1200		230/460	444T	E328	444TTFN6086	✓	4:1	\$18,953	E9	95.0	248/124	2000	41.25		A620	
900		460	445T	L429	445TTFN8115	✓	2:1	\$23,493	E9	93.6	133	2377	43.19	68	A620	
125		3600	460	444TS	E229	444TSTFS6001	✓	2:1	\$18,310	E9	95.4	136	1750	37.50	PW	A232
		3600	460	444TS	E324	444TSTFS16002		2:1	\$18,310	E9	95.4	109	1750	37.50	PW	A232
	1800	460	444T	E214	444TTFS6036	✓	2:1	\$16,286	E9	95.4	141	1850	41.25	PW	A229	
	1800	460	444TS	E810A	444TSTFN16033	✓	2:1	\$16,286	E9	95.4	141	1850	37.50		A621	
	1800	575	444T	E316A	444TTFN6044		2:1	\$16,286	E9	95.4	117	1752	43.35	PW	A620	
	1200	460	445T	E246	445TTFN6086	✓	2:1	\$20,099	E9	95.0	155	2050	43.19		A620	
	900	460	445T	L440A	445TTFN16108		2:1	\$29,309	E9	94.5	172	2118	43.35	H, RB, 68	N/A	
	150	3600	460	445TS	E230	445TSTFN6001	✓	2:1	\$23,314	E9	95.8	165	2050	39.44		A621
		1800	460	445T	E215	445TTFN6036	✓	10:1	\$20,616	E9	95.8	172	2050	43.19	68	A620
1800		460	445TS	E811A	445TSTFN6026	✓	10:1	\$20,616	E9	95.8	172	2050	39.60	68	A621	
1800		575	445T	E317	445TTFN6037		10:1	\$20,616	E9	95.8	138	2050	43.19	PW	A620	
1200		460	445T	E289	445TTFN6087		10:1	\$25,025	E9	95.8	181	2500	43.19	RB	N/A	
900		460	447/9	L442	449TTFS8111		2:1	\$30,815	E6	94.5	206	2872	51.69	H, RB, 68	N/A	
200	3600	460	445TS	E342	445TSTFN16004	✓	2:1	\$27,814	E9	95.8	222	2300	39.44		A621	
	1800	460	445T	E247	445TTFN6038	✓	2:1	\$24,116	E9	96.2	226	2350	43.19	RB	N/A	
	1800	460	445TS	E813A	445TSTFN16033	✓	2:1	\$24,116	E9	96.2	226	2350	39.60		A621	
	1800	575	445T	E326	445TTFN6039		2:1	\$24,116	E9	96.2	181	2350	43.19	RB	N/A	
	1200	460	447/9T	E282	449TTFS6088	✓	2:1	\$29,691	E9	95.8	240	2900	51.69	H, RB	N/A	
	900	460	L447/9T	L449	449TTFS8110	✓	2:1	\$31,343	E9	94.5	270	3225	51.69	H, RB, YD, 68	N/A	
250	3600	460	447/9TS	E271	449TSTFS6003		2:1	\$38,271	E9	96.5	274	2700	47.88	H	A624	
	1800	460	447/9T	L455A	449TTFS16362		10:1	\$31,774	E9	96.5	285	2800	51.86	68, H, YD	A623	
	1800	460	447/9T	E276	449TTFS6038	✓	10:1	\$31,774	E9	96.5	285	2850	51.69	H, RB	N/A	
	1800	575	447/9T	E329	449TTFS16426		10:1	\$31,774	E9	96.5	228	2850	51.86	RB	N/A	
	1200	460	447/9T	L457A	449TTFS16384		10:1	\$36,610	E9	95.8	300	3067	51.86	68, H, YD	A623	
	1200	460	L447/9T	E283	449TTFS6087		10:1	\$36,610	E9	95.8	300	3350	51.69	H, RB	N/A	
	900	460	L447/9T	L471A	449TTFS16102		—	\$39,140	E9	95.0	324	3556	56.79	17, H, RB, YD	N/A	
300	3600	460	447/9TS	E272	449TSTFS6002	✓	2:1	\$49,608	E9	95.8	330	2700	47.88	H	A624	
	1800	460	447/9T	L463A	449TTFS16374	✓	2:1	\$35,945	E9	96.2	341	3150	51.69	H, YD, 68	A623	
	1800	460	447/9T	E277	449TTFS6037		2:1	\$35,945	E9	96.2	339	3150	51.69	H, RB	N/A	
	1800	575	447/9T	L472A	449TTFS16365		2:1	\$46,905	E9	96.2	271	3150	51.69	H, RB, YD	N/A	
	1200	460	L447/9T	L465A	449TTFS16385		—	\$48,336	E9	95.8	363	3850	56.71	H, YD, 17, 68	A623	
	1200	460	L447/9T	E284	449TTFS6390	✓	—	\$48,336	E9	95.8	362	3850	56.71	H, RB	N/A	
350	3600	460	447/9TS	E273	449TSTFS6001	✓	2:1	\$56,889	E9	95.8	380	2898	47.88		A624	
	1800	460	447/9T	E293	449TTFS16333	✓	2:1	\$46,905	E9	96.2	395	3040	51.88	H, RB	N/A	
400	1800	460	447/9T	L469B	449TTFS16364	✓	—	\$47,331	E9	96.2	448	3182	51.85	H, RB	N/A	
	1800	460	L447/9T	E291	449TTFS16334		2:1	\$47,331	E9	96.5	460	3550	56.71	H	A623	
450	1800	460	L447/9T	E292	449TTFS6065		—	\$48,528	E9	96.5	515	3645	56.71	H	A623	

Catalog numbers (Cat No.) highlighted in bold blue are premium efficient.

Blue shaded areas are cast iron frames.

XRI® GENERAL PURPOSE MOTORS

THREE PHASE, TOTALLY ENCLOSED MOTORS

APPLICATIONS:

General purpose use on gear reducers, pumps, machine tools, and other direct-coupled equipment installed in damp, dusty, or dirty environments. Additionally, cast iron frame motors may be suitable for the process industries.

FEATURES:

- Meets or exceeds all NEMA Premium® efficiencies
- Ball bearings, mechanically locked on shaft end
- Rated 60/50 hertz, 190/380 or 380 volt, at next lower horsepower, as noted
- 1.15 Service factor (except as noted)
- Rolled steel 56-145T frame motors accept brake kits, see accessories section, as noted
- UL recognized, CSA certified and CE mark
- Three year warranty



C-FACE FOOTLESS

HP	RPM	VOLTS	FRAME	CAT. NO.	MODEL NO.	STOCK	CT SPEED RANGE*	LIST PRICE	MULT. SYMB.	NOM. EFF.	FL. AMPS	WT.	"C" DIM.	FOOT NOTES
1/4	1800	208-230/460	56C	K252	5K49DN4130	✓	—	\$378	F1	67.4	1.1-1.2/0.6	16	9.52	N, 20, 24, 68, BI
	1800	575	56C	K405	056T17F2047	✓	—	\$378	F1	62.0	0.5	13	9.94	24, BI
1/3	3600	208-230/460	56C	P101	056T34F5306	✓	2:1	\$327	F1	64.0	1.7-2.0/1.0	18	9.94	N, 68, BI
	1800	208-230/460	56C	K253	5K33JNA943	✓	—	\$403	F1	68.8	1.5-1.6/0.8	16	10.60	24, 68, 111, BI
	1800	575	56C	K522	5K33KN67	✓	—	\$403	F1	71.1	0.6	16	10.60	20, 24, 68, BI
1/2	3600	208-230/460	56C	P102	056T34F5321	✓	2:1	\$363	F1	66.0	2.1-2.2/1.1	21	11.82	68, BI
	1800	208-230/460	56C	K254	5K35MNB114	✓	—	\$470	F1	76.1	2.1-2.2/1.1	17	10.93	19, 24, BI
	1800	575	56C	K469	5K42HN4137	✓	—	\$470	F1	80.0	0.8	22	11.01	19, 24, 68, BI
	1200	208-230/460	56C	K1316	5K49MN6020	✓	—	\$740	F1	72.0	2.6-2.6/1.3	27	11.44	19, 24, BI
3/4	3600	208-230/460	56C	P103	056T34F5322	✓	2:1	\$430	F1	72.0	3.0-3.2/1.6	22	11.82	68, BI
	1800	208-230/460	56C	K255	5K36PNB116	✓	—	\$518	F1	78.9	2.8-2.8/1.4	20	11.36	19, 24, 68, BI
	1800	575	56C	K523	5K36PN254	✓	—	\$518	F1	73.4	1.3	20	11.36	19, 24, 68, BI
	1200	208-230/460	56C	K1317	5K49PN6025	✓	—	\$752	F1	76.1	2.9-2.9/1.4	31	12.44	24, BI
	1200	208-230/460	56C	K404	056T11F5320	✓	2:1	\$625	F1	74.0	3.1-3.2/1.6	26	12.32	68, BI
1	1200	208-230/460	143TC	K1318	5K49PN8030	✓	—	\$765	E6	76.1	2.9-2.8/1.4	31	12.56	24, BI
	3000	208-220/440	56C	K633	5K36MN4152	✓	—	\$638	F1	77.0	3.6-3.6/1.8	20	11.36	d, 17, 24, 68, BI
	3600	208-230/460	56C	P104	056T34F5323	✓	2:1	\$483	F1	74.0	3.7-3.7/1.85	24	11.82	d, 68
	3600	230/460	56C	P104A	056T34F99009	✓	4:1	\$540	F1	78.5	3.0/1.5	45	11.82	68, BI
	1800	208-230/460	56C	K256	5K49MN4104	✓	—	\$529	F1	79.2	3.6-3.8/1.9	27	11.44	d, 19, 24, 68, BI
	1800	230/460	56C	G527A	056T17F15660	✓	4:1	\$693	F1	85.5	3.3/1.6	56	14.15	68, A, BI
	1800	575	56C	K524	5K49MN4112	✓	—	\$529	F1	78.2	1.7	27	11.44	d, 19, 24, BI
	1800	575	56C	G528A	056T17F15901	✓	4:1	\$693	F1	85.5	1.3	56	14.15	25, BI
	1800	208-230/460	143TC	C220A	143TFR4329	✓	2:1	\$598	E8	82.5	3.2-3.0/1.5	35	12.87	d, 68
	1800	230/460	143TC	C220B	143TFR16059	✓	10:1	\$629	E9	85.5	3.3/1.6	56	14.21	68
	1800	575	143TC	C230B	143TFR16070	✓	10:1	\$629	E9	85.5	1.3	56	14.21	A, BI
	1200	208-230/460	56C	K1490	5K49PN6164	✓	—	\$770	F1	74.2	3.9-3.8/1.9	31	12.44	d, 24, BI
	1200	230/460	56C	K407A	056T11F15527	✓	10:1	\$869	F1	82.5	3.8/1.9	47	15.21	68
1200	208-230/460	145TC	C250A	145TFR4378	✓	2:1	\$747	E8	80.0	3.6-3.4/1.7	39	13.37	d, 68, BI	
1200	230/460	145TC	C250B	145TFR16088	✓	10:1	\$825	E9	82.5	3.8/1.9	47	15.21	68, BI	
1 1/2	3600	208-230/460	56C	P105	056T34F5324	✓	2:1	\$561	F1	80.0	4.6/2.3	25	11.82	d, 68
	3600	208-230/460	56C	KG235	5K49PN2348	✓	—	\$692	F1	81.7	4.8-4.2/2.1	31	12.44	d, 24, 68, 111, BI
	3600	230/460	56C	P105A	056T34F99032	✓	4:1	\$636	F1	84.0	4.0/2.0	36	13.32	68, BI
	3600	208-230/460	143TC	C201	143TFR5302	✓	2:1	\$574	E8	80.0	4.7-4.6/2.3	35	11.87	d, 68, BI
	3600	230/460	143TC	C201B	143TFR16017	✓	10:1	\$624	E9	84.0	4.4/2.2	41	13.37	68
	1800	208-230/460	56C	K257	5K49SN4117	✓	—	\$582	F1	81.7	4.7-4.4/2.2	35	12.44	d, 19, 24, 68, BI
	1800	230/460	56C	G541A	056T17F15657	✓	4:1	\$657	F1	86.5	4.6/2.3	44	14.65	68, A, BI
	1800	575	56C	G548A	056T17F15674	✓	4:1	\$657	F1	86.5	1.9	44	14.65	BI
	1800	208-230/460	145TC	C221A	145TFR4332	✓	2:1	\$629	E8	84.0	4.6-4.4/2.2	38	14.37	d, 68, BI
	1800	230/460	145TC	C221B	145TFR16353	✓	10:1	\$657	E9	86.5	4.6/2.3	44	14.71	68, BI
	1800	575	145TC	C231B	145TFR16374	✓	10:1	\$657	E9	86.5	1.9	44	14.71	A, BI

Catalog numbers (Cat No.) highlighted in bold blue are premium efficient.

* Requires nameplate modification.

Continued on next page.

GEN. PURPOSE THREE PHASE

NEMA Premium is a trademark of National Electrical Manufacturers Association. All Rights Reserved.

Prices and specifications are subject to change without notice.

XRI® GENERAL PURPOSE MOTORS

THREE PHASE, TOTALLY ENCLOSED MOTORS

C-FACE FOOTLESS

HP	RPM	VOLTS	FRAME	CAT. NO.	MODEL NO.	STOCK	CT SPEED RANGE*	LIST PRICE	MULT. SYMB.	NOM. EFF.	FL. AMPS	WT.	"C" DIM.	FOOT NOTES
2	3600	208-230/460	56C	P106	056T34F5325	√	2:1	\$650	F1	80.0	6.2-6.0/3.0	29	12.32	d, 68, BI
	3600	230/460	56C	P106A	056T34F15600	√	4:1	\$757	F1	85.5	5.0/2.5	47	14.32	68
	3600	208-230/460	56C	KG237	5K49SN2187	√	—	\$792	F1	83.0	5.8-5.4/2.7	35	12.97	d, 24, 68, 110, BI
	3600	230/460	56C	KG237A	056T34F99021	√	10:1	\$951	F1	85.5	5.0/2.5	47	14.32	68, BI
	3600	208-230/460	145TC	C202A	145TTFR4306	√	2:1	\$719	E8	84.0	5.6-5.2/2.6	38	13.37	d, 68, BI
	3600	230/460	145TC	C202B	145TTFR16101	√	10:1	\$746	E9	85.5	5.0/2.5	47	14.37	68, BI
	1800	208-230/460	56C	K1491	5K49ZN4253	√	—	\$626	F1	83.6	6.2-5.8/2.9	45	14.25	d, 24, 68, BI
	1800	208-230/460	56C	G544A	056T17F15665	√	10:1	\$830	F1	86.5	6.4-6.2-6.0/3.0	50	15.15	68, A, BI
	1800	575	56C	G549A	056T17F15903	√	4:1	\$830	F1	86.5	2.4	50	15.15	A, BI
	1800	208-230/460	145TC	K2033	5KE48WN8365	√	—	\$630	E6	84.0	6-5.6/2.8	43	13.84	d, 24, 68, BI
	1800	230/460	145TC	C222A	145TTFR17033	√	10:1	\$721	E9	86.5	6.0/3.0	50	13.92	
	1800	575	145TC	C232B	145TTFR16426		2:1	\$721	E9	86.5	2.4	50	15.21	A
3	3600	230/460	56C	P107A	056T34F15591	√	2:1	\$795	F1	87.5	7.6/3.8	45	14.32	24, 68, A, BI
	3600	230/460	145TC	C236B	145TTFR16105	√	10:1	\$714	E9	87.5	7.6/3.8	47	14.37	24, 68, A
	3600	208-230/460	182TC	C203C	182TTFW16010	√	10:1	\$819	E9	86.5	8.4-7.8/3.9	72	13.47	24, 68
	1800	230/460	182TC	K640A	182TTFW16049	√	10:1	\$910	E9	89.5	7.8/3.9	77	13.97	24, 68, 17
	1800	208-230/460	182TC	C223C	182TTFW16042	√	10:1	\$910	E9	89.5	8.4-7.8/3.9	76	14.47	24, 68
5	3600	230/460	184TC	C204C	184TTFW16012	√	10:1	\$1,010	E9	88.5	12.0/6.0	83	14.97	24, 68
	1800	208-230/460	184TC	C224B	184TTFW16046	√	10:1	\$990	E9	89.5	13.8-12.6/6.3	80	14.97	24, 68
7 1/2	3600	208-230/460	184TC	C238C	184TTFW16013	√	4:1	\$1,023	E9	90.1	19.2-17.6/8.8	75	15.97	24, 68, 17
	3600	230/460	213TC	C205B	213TTFWD16012	√	10:1	\$1,174	E9	89.5	18.6/9.3	105	19.46	24, 68
	1800	230/460	213TC	C225B	213TTFW16047	√	10:1	\$1,050	E9	91.7	19.2/9.6	130	19.46	d, 24, 68
	1800	230/460	213TC	C225C	213TTFWD16047	√	10:1	\$1,050	E9	91.7	19.2/9.6	130	19.46	24, 68
	1200	230/460	254TC	C255B	254TTF16078		10:1	\$2,213	E9	91.0	19.8/9.9	169	24.02	24, 68, AL
10	3600	230/460	215TC	C206B	215TTFWD16010	√	10:1	\$1,360	E9	90.2	23.6/11.8	110	19.46	24, 68
	1800	230/460	215TC	C226B	215TTFWD16051	√	10:1	\$1,370	E9	91.7	26.4/13.2	144	20.96	24, 68
	1200	230/460	256TC	C256B	256TTFNA16096		10:1	\$3,085	E9	91.0	26.2/13.1	368	25.76	24, 68
15	3600	230/460	215TC	C237B	215TTFWD16012	√	2:1	\$1,930	E9	91.0	35.0/17.6	165	20.96	24, 68
	3600	230/460	254TC	C207B	254TTF16007		10:1	\$1,950	E9	91.0	36.0/18.0	261	24.02	24, 68, AL
	1800	230/460	254TC	C227B	254TTF16039	√	10:1	\$1,880	E9	92.4	37.5/18.8	261	24.02	24, 68, AL

Catalog numbers (Cat No.) highlighted in bold blue are premium efficient.
Blue shaded areas are cast iron frames.

* Requires nameplate modification.

XRI® GENERAL PURPOSE MOTORS

THREE PHASE, TOTALLY ENCLOSED MOTORS

FEATURES:

- Meets or exceeds all NEMA Premium® efficiencies
- Ball bearings, mechanically locked on shaft end
- 1.15 Service factor (except as noted)
- Class F insulation (except as noted)
- Rated 60/50 hertz, 190/380 or 380 volt, at next lower horsepower, as noted
- Rolled steel 56-145T frame motors accept brake kits, see accessories section, as noted
- UL recognized, CSA certified and CE mark
- Two year warranty on non bold blue catalog numbers
- Three year warranty on bold blue catalog numbers

ADDITIONAL FEATURES FOR "FOUR-IN-ONE" MOTORS ONLY:

- CR²⁰⁰ corona resistant magnet wire
- Bolt-on, removable rigid base
- Suitable for horizontal and vertical mounting
- Will accept drip cover kits, see accessories section

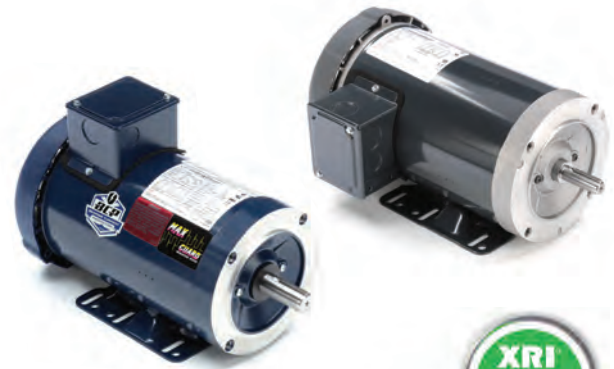

C-FACE FOOTED (RIGID AND REMOVABLE BASE)

HP	RPM	VOLTS	FRAME	4-IN-1® MOTORS	CAT. NO.	MODEL NO.	STOCK	CT SPEED RANGE*	LIST PRICE	MULT. SYMB.	NOM. EFF.	FL. AMPS	WT.	"C" DIM.	FOOT NOTES
1/4	1800	208-230/460	56C		G565	056T17F2051		2:1	\$386	F1	62.5	1.2-1.4/0.7	14	9.94	24,68,BI
	1200	208-230/460	56C	YES	G586	056T11F5311	√	2:1	\$547	F2	52.5	1.7-2.0/1.0	19	11.31	6,13,68
1/3	3600	208-230/460	56C	YES	D390	056T34F5303	√	1000:1	\$346	F2	66.0	1.7-1.8/0.9	20	10.43	6,13,24,68,N
	3600	575	56C	YES	K702	056T34F5309		1000:1	\$346	F2	64.0	0.8	19	9.93	6,13,24,N
	1800	208-230/460	56C		K1322	5K42FN4035	√	—	\$430	F1	69.2	1.5-1.6/0.8	20	11.01	20,24,68
	1800	208-230/460	56C	YES	G580	056T17F5305	√	1000:1	\$443	F2	68.0	1.4-1.6/0.8	20	9.93	6,13,24,68,N
	1800	575	56C	YES	K703	056T17F5316	√	1000:1	\$443	F2	68.0	0.7	20	9.93	6,13,24,N
	1200	208-230/460	56C	YES	G587	056T11F5310	√	10:1	\$575	F2	62.0	1.9-2.2/1.1	21	11.31	6,13,68
1/2	3600	208-230/460	56C		G569	056T34F5308		2:1	\$371	F1	66.0	2.1-2.2/1.1	23	11.82	13,68,BI
	3600	208-230/460	56C	YES	D391	056T34F5301	√	10:1	\$386	F2	66.0	2.1-2.2/1.1	22	11.81	6,13,68
	3600	575	56C	YES	K704	056T34F5348	√	10:1	\$386	F2	66.0	0.9	22	11.81	6,13
	1800	208-230/460	56C		K1324	5K42HN4034	√	—	\$477	F1	74.7	2.3-2.2/1.1	22	11.01	19,24,68
	1800	208-230/460	56C	YES	G581	056T17F5321	√	10:1	\$491	F2	68.0	2.3-2.4/1.2	24	11.81	6,13,68
	1800	575	56C	YES	K705	056T17F5336	√	10:1	\$491	F2	68.0	1.0	23	11.81	6,13
	1200	208-230/460	56C	YES	G588	056T11F5309	√	10:1	\$626	F2	68.0	2.4-2.7/1.35	23	11.81	6,13,68
	3/4	3600	208-230/460	56C	YES	D392	056T34F5302	√	4:1	\$449	F2	68.0	3.0-3.2/1.6	23	11.81
3600		575	56C	YES	K706	056T34F5349	√	4:1	\$449	F2	68.0	1.3	23	11.81	6,13
1800		208-230/460	56C		K258	5K49KN4124	√	—	\$526	F1	74.3	3.3-3.0/1.5	24	11.41	19,24,68
1800		208-230/460	56C	YES	G582	056T17F5322	√	10:1	\$537	F2	75.5	2.6-3.0/1.5	40	11.81	6,13,68
1800		575	56C	YES	K707	056T17F5337	√	10:1	\$537	F2	75.5	1.2	24	11.81	6,13
1200		208-230/460	56C	YES	G589	056T11F5308	√	4:1	\$645	F2	74.0	3.1-3.2/1.6	27	12.31	6,13,68
1	3600	230/460	56C		K500A	056T34F15598	√	4:1	\$564	F1	78.5	3.0/1.5	24	11.81	19,24,68, BI
	3600	230/460	56C	YES	D393A	056T34F99008	√	10:1	\$577	F2	78.5	3.0/1.5	26	11.81	6,13,68
	3600	575	56C	YES	K708A	056T34F99010	√	10:1	\$577	F2	78.5	1.2	24	11.81	6,13
	1800	230/460	56C		G563A	056T17F15658	√	4:1	\$610	F1	85.5	3.3/1.6	42	14.15	13,19,68,A, BI
	1800	230/460	56HC	YES	G583A	056T17F15639	√	10:1	\$626	F2	85.5	3.3/1.6	42	14.15	5,6,13,68
	1800	575	56HC	YES	K709A	056T17F15642	√	10:1	\$626	F2	85.5	1.3	42	14.15	5,6,13
	1200	230/460	56HC	YES	K701A	056T11F15521	√	10:1	\$795	F2	82.5	3.8/1.9	47	15.15	5,6,13,68

Catalog numbers (Cat No.) highlighted in bold blue have efficiency levels that meet the USA efficiency legislations.

* Requires nameplate modification.

Continued on next page.

GEN. PURPOSE THREE PHASE

NEMA Premium is a trademark of National Electrical Manufacturers Association. All Rights Reserved.

XRI® GENERAL PURPOSE MOTORS

THREE PHASE, TOTALLY ENCLOSED MOTORS

C-FACE FOOTED (RIGID AND REMOVABLE BASE)

HP	RPM	VOLTS	FRAME	4-IN-1® MOTORS	CAT. NO.	MODEL NO.	STOCK	CT SPEED RANGE*	LIST PRICE	MULT. SYMB.	NOM. EFF.	FL. AMPS	WT.	"C" DIM.	FOOT NOTES	
1 1/2	3600	230/460	56C	YES	D394A	056T34F99017	✓	10:1	\$689	F2	84.0	4.0/2.0	37	13.31	6, 13, 68	
	3600	575	56C	YES	K721A	056T34F99020	✓	10:1	\$689	F2	84.0	1.6	37	13.31	6, 13, F	
	1800	208-230/460	56C		G564A	056T17F15664	✓	10:1	\$773	F1	86.5	4.7-4.6/2.3	44	14.66	13, 19, 68, A, BI	
	1800	230/460	56HC	YES	G584	056T17F5324	✓	10:1	\$599	F2	80.0	4.8/2.4	30	12.31	d, 5, 6, 13, 68	
	1800	230/460	56HC	YES	G584A	056T17F15641	✓	10:1	\$692	F2	86.5	4.6/2.3	45	14.65	5, 6, 13, 68	
	1800	575	56HC	YES	K722A	056T17F15645	✓	10:1	\$795	F2	86.5	1.8	45	14.65	5, 6, 13	
	1800	200	145TC		U703A	—		10:1	\$606	E9	86.5	5.2	44	14.71	13	
	1200	230/460	182TC	YES	K700A	182TTFW16085	✓	10:1	\$840	F2	87.5	87.5	6.0/3.0	70	14.47	6, 13, 17
2	3600	230/460	56HC	YES	D395A	056T34F99012	✓	10:1	\$795	F2	85.5	5.0/2.5	45	14.31	6, 13, 68	
	3600	575	56HC	YES	K723A	056T34F99015	✓	10:1	\$795	F2	85.5	2	48	14.31	5, 6, 13	
	1800	230/460	56HC		K806A	056T17F15646	✓	10:1	\$653	F1	86.5	6.0/3.0	49	15.15	5, 13, 68, A, BI	
	1800	230/460	56HC	YES	G585A	056T17F15640	✓	10:1	\$752	F2	86.5	6.0/3.0	48	15.15	5, 6, 13, 68	
	1800	575	56HC	YES	K724A	056T17F15644	✓	10:1	\$752	F2	86.5	2.4	48	15.15	5, 6, 13	
	1800	200	145TC		U706A	—		10:1	\$705	E9	86.5	6.2	50	13.92	13	
	1200	230/460	184TC	YES	C380B	184TTFW16051	✓	10:1	\$1,050	F2	88.5	88.5	6.4/3.2	125	14.97	6, 24, 68
	3	3600	208-230/460	56HC	YES	D396	056T34F5306	✓	2:1	\$767	F2	84.0	8.4-7.6/3.8	41	13.31	d, 5, 6, 13, 68
3600		230/460	56HC	YES	D396A	056T34F99014	✓	10:1	\$885	F2	87.5	7.6/3.8	52	14.31	6, 13, 68	
3600		575	56HC	YES	K725A	056T34F15593	✓	10:1	\$885	F2	87.5	3.0	46	14.31	5, 6, 13, A	
3600		230/460	182TC	YES	C381B	182TTFW16021	✓	10:1	\$969	F2	86.5	7.6/3.8	73	14.47	6, 13, 24, 68	
3600		200	182TC		U736A	—		10:1	\$898	E9	87.5	7.8	47	14.37	13, 24	
1800		230/460	182TC	YES	G590A	182TTFW16045	✓	10:1	\$988	F2	89.5	7.8/3.9	83	14.47	6, 13, 17, 68	
1800		575	182TCZ	YES	G591A	182TTFW16047	✓	10:1	\$988	F2	89.5	3.2	75	13.97	6, 11, 13, 17	
1800		230/460	182TC	YES	C382B	182TTFW16030	✓	10:1	\$1,077	F2	89.5	7.8/3.9	75	14.47	6, 24, 68	
1800		575	182TC	YES	C383A	182TTFW4345		4:1	\$925	F2	87.5	3.3	76	15.5	d, 6, 13, 24	
1800		575	182TC	YES	C383B	182TTFW16027	✓	10:1	\$1,077	F2	89.5	3.2	75	15.5	6, 24	
1200		230/460	213TC	YES	C384A	213TTFW16078	✓	10:1	\$1,390	F2	89.5	8.8/4.4	126	20.97	d, 6, 24, 68	
1200		208-230/460	213TC	YES	C384B	213TTFWD16078	✓	10:1	\$1,390	F2	89.5	9.2-8.8/4.4	126	19.47	6, 24, 68	
5	3600	200	184TC		U738A	—		10:1	\$1,180	E9	88.5	12.4	85	14.97	13, 24	
	3600	230/460	184TC	YES	C385B	184TTFW16006	✓	10:1	\$1,330	F2	88.5	12.0/6.0	85	14.97	6, 13, 24, 68	
	1800	230/460	184TC	YES	C386B	184TTFW16027	✓	10:1	\$1,328	F2	89.5	12.6/6.3	87	14.97	6, 13, 24, 68	
	1800	575	184TC	YES	C387B	184TTFW16029	✓	10:1	\$1,328	F2	89.5	5.1	87	16.5	6, 13, 24	
	1200	230/460	215TC	YES	C388A	215TTFW16079	✓	10:1	\$1,599	F2	90.2	14.0/7.0	158	22.22	d, 6, 13, 24, 68	
	1200	208-230/460	215TC	YES	C388B	215TTFWD16079	✓	10:1	\$1,599	F2	90.2	14.8-14.0/7.0	158	20.97	6, 13, 24, 68, A	
	7 1/2	3600	200	213TC		U740A	—		10:1	\$1,389	E9	90.2	19.9	125	20.97	24
3600		230/460	213TC	YES	C389A	213TTFW16008	✓	10:1	\$1,509	F2	90.2	17.8/8.9	125	20.97	d, 6, 24, 68	
3600		208-230/460	213TC	YES	C389B	213TTFWD16008	✓	10:1	\$1,509	F2	90.2	19.7-18.6/9.3	100	19.47	6, 24, 68	
1800		230/460	213TC	YES	C390A	213TTFW16035	✓	10:1	\$1,549	F2	91.7	18.6/9.3	157	22.22	d, 6, 24, 68	
1800		208-230/460	213TC	YES	C390B	213TTFWD16035	✓	10:1	\$1,549	F2	91.7	20.8-19.6/9.8	146	19.47	6, 24, 68	
1800		575	213TC	YES	C391A	213TTFW16036	✓	10:1	\$1,549	F2	91.7	7.5	157	22.22	d, 6, 24, 68	
1800		575	213TC	YES	C391B	213TTFWD16036	✓	10:1	\$1,549	F2	91.7	7.9	157	19.47	6, 24	
10		3600	200	215TC		U743A	215TTFWD16018		10:1	\$1,499	E9	91.7	27.2	180	20.97	24
	3600	230/460	215TC	YES	C392A	215TTFW16005	✓	10:1	\$1,609	F2	91.7	23.6/11.8	139	22.22	d, 6, 24, 68	
	3600	208-230/460	215TC	YES	C392B	215TTFWD16005	✓	10:1	\$1,609	F2	91.7	25.9-23.6/11.8	139	19.47	6, 24, 68	
	1800	200	215TC		U718A	—		10:1	\$1,525	E9	91.7	28.4	189	22.22	24	
	1800	230/460	215TC	YES	C393A	215TTFW16041	✓	10:1	\$1,630	F2	91.7	26.0/13.0	189	22.22	d, 6, 24, 68	
	1800	208-230/460	215TC	YES	C393B	215TTFWD16041	✓	10:1	\$1,630	F2	91.7	14-26.4/13.2	189	20.97	6, 24, 68	
	1800	575	215TC	YES	C394A	215TTFW16042	✓	10:1	\$1,630	F2	91.7	10.9	208	22.22	6, 24	
15	1800	200	254TC		U721A	254TFL16041		10:1	\$1,940	E9	92.4	43.5	205	23.40	AL, 24	
	1800	230/460	254TC		U722A	—		10:1	\$1,940	E9	92.4	41.0/22.0	205	23.40	AL, 24	
	1800	575	254TC		U723A	254TFL16032		10:1	\$1,940	E9	92.4	15.1	205	23.40	AL, 24	

Catalog numbers (Cat No.) highlighted in bold blue are premium efficient.

* Requires nameplate modification.

XRI® GENERAL PURPOSE MOTORS

THREE PHASE, TOTALLY ENCLOSED MOTORS

C-FACE FOOTED (RIGID BASE) - F3 MOUNT

HP	RPM	VOLTS	FRAME	MOUNTING	CAT. NO.	MODEL NO.	STOCK	CT SPEED RANGE	LIST PRICE	MULT. SYMB.	NOM. EFF.	FL. AMPS	WT.	"C" DIM.	FOOT NOTES
1	3600	208-230/460	56C	F3	E2000	056T34F5940	√	10:1	\$944	F1	80.0	3.0-2.8/1.4	24	11.31	68
	1800	230/460	143TC	F3	E2001A	143TTFR16053	√	10:1	\$770	E9	85.5	3.2/1.6	32	13.75	68, P
	1200	230/460	145TC	F3	E2002	145TTFR6078	√	10:1	\$850	E9	82.5	3.8/1.9	42	13.75	68
1 1/2	3600	230/460	143TC	F3	E2003	143TTFR5582	√	10:1	\$689	E9	84.0	4.0/2.0	37	13.75	
	1800	230/460	145TC	F3	E2004A	145TTFR16331	√	10:1	\$810	E9	86.5	4.6/2.3	34	13.75	68, P
	1200	230/460	182TC	F3	E2005	182TTFW6076	√	10:1	\$936	E9	87.5	5.1/2.6	59	14.47	68
2	3600	230/460	145TC	F3	E2006	145TTFR3002	√	10:1	\$763	E9	85.5	4.8/2.4	44	13.75	68
	1800	230/460	145TC	F3	E2007A	145TTFR16329	√	10:1	\$870	E9	86.5	6.0/3.0	50	14.25	68, A, P
	1200	230/460	184TC	F3	E2008	184TTFW6076	√	10:1	\$1,073	E9	88.5	6.4/3.2	94	14.97	68
3	3600	230/460	182TC	F3	E2009	182TTFW6001	√	10:1	\$989	E9	87.5	7.8/3.9	83	13.97	68
	1800	230/460	182TC	F3	E2010	182TTFW6026	√	10:1	\$996	E9	89.5	7.8/3.9	87	13.97	68, P
	1200	230/460	213TC	F3	E2011	213TTFW6076	√	10:1	\$1,309	E9	89.5	8.8/4.4	115	19.47	d
	1200	208-230/460	213TC	F3	E2011A	213TTFWD6076	√	10:1	\$1,309	E9	89.5	9.2-8.8/4.4	115	19.47	
5	3600	230/460	184TC	F3	E2012	184TTFW6001	√	10:1	\$1,146	E9	88.5	12.0/6.0	95	14.97	68
	1800	230/460	184TC	F3	E2013	184TTFW6026	√	10:1	\$1,093	E9	90.2	12.6/6.3	110	14.97	68, P
	1200	230/460	215TC	F3	E2014	215TTFW6076	√	10:1	\$1,685	E9	90.2	14.0/7.0	135	20.97	d, 68
	1200	208-230/460	215TC	F3	E2014A	215TTFWD6076	√	10:1	\$1,685	E9	90.2	14.8-14.0/7.0	135	20.97	68
7 1/2	3600	230/460	213TC	F3	E2015	213TTFW6001	√	10:1	\$1,409	E9	91.7	17.8/8.9	116	20.97	d
	3600	208-230/460	213TC	F3	E2015A	213TTFWD6001	√	10:1	\$1,409	E9	91.7	19.7-18.6/9.3	116	19.47	
	1800	230/460	213TC	F3	E2016A	213TTFW16039	√	10:1	\$1,509	E9	91.7	19.4/9.7	143	20.97	d, 68, P
	1800	208-230/460	213TC	F3	E2016B	213TTFWD16039	√	10:1	\$1,509	E9	91.7	20.8-19.6/9.8	143	19.47	68, P
10	3600	230/460	215TC	F3	E2018	215TTFW6001	√	10:1	\$1,565	E9	91.7	23.6/11.8	137	22.22	68
	3600	230/460	215TC	F3	E2018A	215TTFWD6001	√	10:1	\$1,565	E9	91.7	23.6/11.8	133	19.47	d, 68, P
	1800	230/460	215TC	F3	E2019	215TTFW6026	√	10:1	\$1,535	E9	91.7	25.6/12.8	164	22.22	d
	1800	230/460	215TC	F3	E2019A	215TTFW16047	√	10:1	\$1,535	E9	91.7	25.6/12.8	164	22.22	d, P
	1800	208-230/460	215TC	F3	E2019B	215TTFWD16047	√	10:1	\$1,535	E9	91.7	14.0-26.4/13.2	170	22.22	P

Catalog numbers (Cat No.) highlighted in bold blue are premium efficient.

BRAKE KITS FOR

56-143-145 FRAMES ONLY (EXCEPT AS NOTED)

TORQUE (LB-FT)	COIL VOLTAGE	CAT. NO.	STOCK	LIST (LOOSE)	LIST (INSTALLED)	MULT. SYMB.	WT.
3	208-230/460	A301	√	\$634	\$899	S4	10
	208-230/460	A1301		\$634	\$899	S4	10
	575	A297	√	\$634	\$899	S4	10
	575	A1297		\$634	\$899	S4	3
6	208-230/460	A302	√	\$747	\$1,083	S4	11
	208-230/460	A1302		\$747	\$1,083	S4	10
	575	A298	√	\$747	\$1,083	S4	11
	575	A1298		\$747	\$1,083	S4	10
10	208-230/460	A303	√	\$924	\$1,260	S4	10
	208-230/460	A1303		\$924	\$1,260	S4	10
	575	A299	√	\$924	\$1,260	S4	10
	575	A1299		\$924	\$1,260	S4	10

DRIP COVER KITS (4-IN-1® MOTORS)

CAT. NO.	STOCK	FRAME	LIST PRICE	MULT. SYMB.	WT.
A234	√	56-143T-145T	\$38	S4	2
A197	√	182T-184T	\$43	S4	3
A199	√	213T-215T	\$49	S4	5

GLOBETROTTER® GENERAL PURPOSE MOTORS

THREE PHASE, TOTALLY ENCLOSED MOTORS

FEATURES:

- Meets or exceeds NEMA Premium® efficiencies
- NEMA Premium models are in compliance with EISA 2007
- Cast iron frame material, as noted
- Rolled steel C-face models are Hazardous Duty® Division 2 motors
- Hazardous Duty Division 2 UL certification nameplate, as noted
- Division 2 / Zone 2 Class 1 (gases), Groups A, B, C, D
- IP55 enclosure on cast iron frames, as noted
- Inverter duty 10:1 variable torque and 10:1 constant torque, 1.0 SF
- 1.15 Service factor on sinewave, 1.0 service factor on IGBT power
- Meets temperature code T2B
- Class F Insulation
- Standard assembly F1, reversible to F2 assembly
- For C-Face, D-Flange, or cast iron upgrade kits, see accessory section
- UL recognized, CSA certified, CE mark
- Three year warranty



IP55

RIGID BASE

HP	RPM	VOLTS	FRAME	DIV. II & IP55	CAT NO.	MODEL NO.	STOCK	LIST PRICE	MULT. SYMB.	NOM. EFF.	FL. AMPS	WT.	"C" DIM	FOOT NOTES	C-FACE KITS
1	1800	200	143T	N	TE104	Century®	√	\$817	E1	85.5	3.1	53	13.20		WD140TCF
	1800	208-230/460	143T	N	TE102	Century	√	\$817	E1	85.5	3-2.7/1.4	53	13.20		WD140TCF
	1800	575	143T	N	TE103	Century	√	\$817	E1	85.5	1.1	53	13.20		WD140TCF
	1200	208-230/460	145T	N	TE100	Century	√	\$938	E1	82.5	3.5-3.2/1.6	64	14.20		WD140TCF
	1200	575	145T	N	TE101	Century	√	\$938	E1	82.5	1.3	64	14.20		WD140TCF
1 1/2	3600	208-230/460	143T	N	TE110	Century	√	\$951	E1	84.0	4.3-3.9/1.9	56	13.20		WD140TCF
	3600	575	143T	N	TE111	Century	√	\$951	E1	84.0	1.6	56	13.20		WD140TCF
	1800	200	145T	N	TE107	Century	√	\$905	E1	86.5	4.5	62	14.20		WD140TCF
	1800	208-230/460	145T	N	TE108	Century	√	\$905	E1	86.5	4.3-3.9/2	62	14.20		WD140TCF
	1800	230/460	145T	N	GT1004	145TTFC6026	√	\$690	E1	86.5	4.0/2.0	62	14.20	75	—
	1800	575	145T	N	TE109	Century	√	\$905	E1	86.5	1.6	62	14.20		WD140TCF
	1200	208-230/460	182T	N	TE105	Century	√	\$1,022	E1	87.5	5.1-4.7/2.3	99	14.80	d	WD180TCFS
	1200	230/460	182T	N	GT1005	182TTFC6076	√	\$847	E1	87.5	4.8/2.4	89	14.80	d, 75	A644
	1200	230/460	182T	Y	GT1005A	182TTFCD6076	√	\$847	E1	87.5	4.8/2.4	89	14.80	75	A420
	1200	575	182T	N	TE106	Century	√	\$1022	E1	87.5	1.9	100	14.80	d	WD180TCFS
2	1200	575	182T	N	GT1105	182TTFC6080	√	\$847	E1	87.5	1.9	89	14.80	d, 75	A644
	1200	575	182T	Y	GT1105A	182TTFCD6080	√	\$847	E1	87.5	1.9	89	14.80	75	A420
	3600	208-230/460	145T	N	TE117	Century	√	\$1,014	E1	85.5	5.5-5/2.5	60	14.20		WD140TCF
	3600	575	145T	N	TE118	Century	√	\$1,014	E1	85.5	2.0	60	14.20		WD140TCF
	1800	200	145T	N	TE114	Century	√	\$963	E1	86.5	5.8	60	14.20		WD140TCF
	1800	208-230/460	145T	N	TE115	Century	√	\$963	E1	86.5	5.6-5.1/2.5	60	14.20	d	WD140TCF
	1800	230/460	145T	N	GT1007	145TTFC6027	√	\$809	E1	86.5	5.0/2.5	60	14.20	75	—
	1800	575	145T	N	TE116	Century	√	\$963	E1	86.5	2.0	60	14.20		WD140TCF
	1200	208-230/460	184T	N	TE112	Century	√	\$1,231	E1	88.5	6.7-6/3	113	15.81	d	WD180TCFS
	1200	230/460	184T	N	GT1008	184TTFC6076	√	\$1,050	E1	88.5	6.0/3.0	125	15.81	d, 75	A644
3	1200	230/460	184T	Y	GT1008A	184TTFCD6076	√	\$1,050	E1	88.5	6.0/3.0	125	15.81	75	A420
	1200	575	184T	N	TE113	Century	√	\$1,231	E1	88.5	2.4	113	15.81	d	WD180TCFS
	1200	575	184T	N	GT1108	184TTFC6080	√	\$1,050	E1	88.5	2.4	125	15.81	d, 75	A644
	1200	575	184T	Y	GT1108A	184TTFCD6080	√	\$1,050	E1	88.5	2.4	125	15.81	75	A420
	3600	208-230/460	182T	N	TE124	Century	√	\$1,193	E1	86.5	8.4-7.6/3.8	92	14.80	d	WD180TCFS
	3600	230/460	182T	N	GT1009	182TTFC6001	√	\$978	E1	86.5	7.6/3.8	94	14.80	d, 75, A	A644
	3600	230/460	182T	Y	GT1009A	182TTFCD6001	√	\$978	E1	86.5	7.6/3.8	94	14.80	75, A	A420
	3600	575	182T	N	TE125	Century	√	\$1,193	E1	86.5	3.0	95	14.80	d	WD180TCFS
	3600	575	182T	N	GT1109	182TTFC6005	√	\$978	E1	86.5	3.1	94	14.80	d, 75	A644

Catalog numbers (Cat No.) highlighted in bold blue are premium efficient.
Blue shaded areas are cast iron frames.

Continued on next page.

NEMA Premium is a trademark of National Electrical Manufacturers Association. All Rights Reserved.

Prices and specifications are subject to change without notice.

GLOBETROTTER® GENERAL PURPOSE MOTORS

THREE PHASE, TOTALLY ENCLOSED MOTORS

RIGID BASE

HP	RPM	VOLTS	FRAME	DIV. II & IP55	CAT NO.	MODEL NO.	STOCK	LIST PRICE	MULT. SYMB.	NOM. EFF.	FL. AMPS	WT.	"C" DIM	FOOT NOTES	C-FACE KITS	
3	3600	575	182T	Y	GT1109A	182TTFCD6005	✓	\$978	E1	86.5	3.1	94	14.80		A420	
	1800	200	182T	N	TE123	Century®	✓	\$1,116	E1	89.5	8.9	104	15.15		WD180TCFS	
	1800	208-230/460	182T	N	TE121	Century	✓	\$1,116	E1	89.5	8.6-7.7/3.9	99	14.80	d	WD180TCFS	
	1800	230/460	182T	N	GT1010	182TTFCD6026	✓	\$934	E1	89.5	7.8/3.9	102	14.80	d, 75	A644	
	1800	230/460	182T	Y	GT1010A	182TTFCD6026	✓	\$934	E1	89.5	7.8/3.9	102	14.80	75	A420	
	1800	575	182T	N	TE122	Century	✓	\$1,116	E1	89.5	3.1	104	14.80	d	WD180TCFS	
	1800	575	182T	N	GT1110	182TTFCD6030	✓	\$934	E1	89.5	3.1	102	14.80	d, 75	A644	
	1800	575	182T	Y	GT1110A	182TTFCD6030	✓	\$934	E1	89.5	3.1	102	14.80	75	A420	
	1200	208-230/460	213T	N	TE119	Century	✓	\$1,676	E1	89.5	9.6-8.7/4.4	178	18.23	d	WD210TCFS	
	1200	230/460	213T	N	GT1011	213TTFCD6076	✓	\$1,420	E1	89.5	8.6/4.3	173	18.23	d, 75	A206	
	1200	230/460	213T	Y	GT1011A	213TTFCD6076	✓	\$1,420	E1	89.5	8.6/4.3	173	18.53	75	A421	
	1200	575	213T	N	TE120	Century	✓	\$1,676	E1	89.5	3.5	184	18.23	d	WD210TCFS	
	1200	575	213T	N	GT1111	213TTFCD6080	✓	\$1,420	E1	89.5	3.5	173	18.23	d, 75	A206	
	1200	575	213T	Y	GT1111A	213TTFCD6080	✓	\$1,420	E1	89.5	3.5	173	18.53	75	A421	
	5	3600	208-230/460	184T	N	TE131	Century	✓	\$1,327	E1	88.5	14-12/6.2	106	15.81	d	WD180TCFS
3600		230/460	184T	N	GT1012	184TTFCD6001	✓	\$1,120	E1	88.5	12.0/6.0	109	15.81	d, A, 75	A644	
3600		230/460	184T	Y	GT1012A	184TTFCD6001	✓	\$1,120	E1	88.5	12.0/6.0	109	15.81	75, A	A420	
3600		575	184T	N	TE132	Century	✓	\$1,327	E1	88.5	4.9	106	15.81	d	WD180TCFS	
3600		575	184T	N	GT1112	184TTFCD6005	✓	\$1,120	E1	88.5	4.8	109	15.81	d, 75	A644	
3600		575	184T	Y	GT1112A	184TTFCD6005	✓	\$1,120	E1	88.5	4.8	109	15.81	75	A420	
1800		200	184T	N	TE128	Century	✓	\$1,255	E1	89.5	15.0	115	16.14		WD180TCFS	
1800		208-230/460	184T	N	TE129	Century	✓	\$1,255	E1	89.5	14-13/6.4	115	15.81	d	WD180TCFS	
1800		230/460	184T	N	GT1013	184TTFCD6026	✓	\$1,070	E1	89.5	12.4/6.2	117	15.81	d, 75, A	A644	
1800		230/460	184T	Y	GT1013A	184TTFCD6026	✓	\$1,070	E1	89.5	12.4/6.2	117	15.81	75, A	A420	
1800		575	184T	N	TE130	Century	✓	\$1,255	E1	89.5	5.1	115	15.81	d	WD180TCFS	
1800		575	184T	N	GT1113	184TTFCD6030	✓	\$1,070	E1	89.5	5.0	117	15.81	d, 75	A644	
1800		575	184T	Y	GT1113A	184TTFCD6030	✓	\$1,070	E1	89.5	5.0	117	15.81	75	A420	
1200		208-230/460	215T	N	TE126	Century	✓	\$2,079	E1	89.5	16-14/7.1	189	19.73	d	WD210TCFS	
1200		230/460	215T	N	GT1014	215TTFCD6076	✓	\$1,630	E1	89.5	14/7.0	203	19.73	d, 75	A206	
1200		230/460	215T	Y	GT1014A	215TTFCD6076	✓	\$1,630	E1	89.5	13.6/6.8	168	20.03	75	A421	
1200		575	215T	N	TE127	Century	✓	\$2,079	E1	89.5	5.7	193	19.73	d	WD210TCFS	
1200		575	215T	N	GT1114	215TTFCD6080	✓	\$1,630	E1	89.5	5.6	203	19.73	d, 75	A206	
1200		575	215T	Y	GT1114A	215TTFCD6080	✓	\$1,630	E1	89.5	5.5	158	20.03	75	A421	
7 1/2		3600	208-230/460	213T	N	TE138	Century	✓	\$1,739	E1	89.5	20-19/9.2	170	18.23	d	WD210TCFS
		3600	230/460	213T	N	GT1015	213TTFCD6001	✓	\$1,245	E1	89.5	17.8/8.9	185	18.23	d, 75, A	A206
	3600	230/460	213T	Y	GT1015A	213TTFCD6001	✓	\$1,245	E1	89.5	18.4/9.2	185	18.53	75, A	A421	
	3600	575	213T	N	TE139	Century	✓	\$1,739	E1	89.5	7.0	202	18.23	d	WD210TCFS	
	3600	575	213T	N	GT1115	213TTFCD6005	✓	\$1,245	E1	89.5	7.1	185	18.23	d, 75	A206	
	3600	575	213T	Y	GT1115A	213TTFCD6005	✓	\$1,245	E1	90.3	7.4	185	18.53	75	A421	
	1800	200	213T	N	TE135	Century	✓	\$1,651	E1	91.7	22.0	175	18.23		WD210TCFS	
	1800	208-230/460	213T	N	TE136	Century	✓	\$1,651	E1	91.7	21-19/9.6	175	18.23	d	WD210TCFS	
	1800	230/460	213T	N	GT1016	213TTFCD6026	✓	\$1,201	E1	91.7	18.6/9.3	194	18.23	d, 75	A206	
	1800	230/460	213T	Y	GT1016A	213TTFCD6026	✓	\$1,201	E1	93.3	19.0/9.5	194	18.53	75	A421	
	1800	575	213T	N	TE137	Century	✓	\$1,651	E1	91.7	7.7	1,812	18.23	d	WD210TCFS	
	1800	575	213T	N	GT1116	213TTFCD6030	✓	\$1,201	E1	91.7	7.5	194	18.23	d, 75	A206	
	1800	575	213T	Y	GT1116A	213TTFCD6030	✓	\$1,201	E1	93.3	7.6	194	18.53	75	A421	
	1200	208-230/460	254T	N	TE133	Century	✓	\$2,750	E1	91.0	23-21/10	330	26.66	d	WD250TCCFF2	
	1200	230/460	254T	N	GT1017	254TTFCA6076	✓	\$2,056	E1	91.0	20.4/10.2	223	23.70	d, 75	A173	
	1200	230/460	254T	Y	GT1017A	254TTFCD6076	✓	\$2,056	E1	91.0	19.8/9.9	223	24.15	75	A173A	
	1200	575	254T	N	TE134	Century	✓	\$2,750	E1	91.0	8.2	305	26.66	d	WD250TCCFF2	
	1200	575	254T	N	GT1117	254TTFCA6080	✓	\$2,056	E1	91.0	8.4	223	26.60	d, 75	A173	
1200	575	254T	Y	GT1117A	254TTFCD6080	✓	\$2,056	E1	91.0	7.9	223	24.15	75	A173A		
10	3600	208-230/460	215T	N	TE145	Century	✓	\$2,030	E1	90.2	26-24/12	200	19.73	d	WD210TCFS	
	3600	230/460	215T	N	GT1018	215TTFCD6001	✓	\$1,509	E1	90.2	22.8/11.4	217	19.73	d, 75	A206	
	3600	230/460	215T	Y	GT1018A	215TTFCD6001	✓	\$1,509	E1	90.2	23.6/11.8	171	20.03	75	A421	
	3600	575	215T	N	TE146	Century	✓	\$2,030	E1	90.2	9.4	218	19.73	d	WD210TCFS	
	3600	575	215T	N	GT1118	215TTFCD6005	✓	\$1,509	E1	90.2	9.1	217	19.73	d, 75	A206	
	3600	575	215T	Y	GT1118A	215TTFCD6005	✓	\$1,509	E1	90.2	9.5	220	20.03	75	A421	

Catalog numbers (Cat No.) highlighted in bold blue are premium efficient.

Blue shaded areas are cast iron frames.

Continued on next page.

GEN. PURPOSE THREE PHASE

GLOBETROTTER® GENERAL PURPOSE MOTORS

THREE PHASE, TOTALLY ENCLOSED MOTORS

RIGID BASE

HP	RPM	VOLTS	FRAME	DIV. II & IP55	CAT NO.	MODEL NO.	STOCK	LIST PRICE	MULT. SYMB.	NOM. EFF.	FL. AMPS	WT.	"C" DIM	FOOT NOTES	C-FACE KITS
10	1800	200	215T	N	TE142	Century®	✓	\$1,988	E1	91.7	28.3	200	19.73		WD210TCFS
	1800	208-230/460	215T	N	TE143	Century	✓	\$1,988	E1	91.7	27-25/12	200	19.73	d	WD210TCFS
	1800	230/460	215T	N	GT1019	215TTFC6026	✓	\$1,479	E1	91.7	24.4/12.2	225	19.73	d, 75	A206
	1800	230/460	215T	Y	GT1019A	215TTFCD6026	✓	\$1,479	E1	92.1	25.0/12.5	183	20.03	75	A421
	1800	575	215T	N	TE144	Century	✓	\$1,988	E1	91.7	9.8	209	19.73	d	WD210TCFS
	1800	575	215T	N	GT1119	215TTFC6030	✓	\$1,479	E1	91.7	9.8	225	19.73	d, 75	A206
	1800	575	215T	Y	GT1119A	215TTFCD6030	✓	\$1,479	E1	92.1	10.0	183	20.03	75	A421
	1200	208-230/460	256T	N	TE140	Century	✓	\$3,359	E1	91.0	30-27/14	360	25.43	d	WD250TCCFF2
	1200	230/460	256T	N	GT1020	256TTFCA6076	✓	\$2,585	E1	91.0	26.8/13.4	368	25.43	d, 75	A173
	1200	230/460	256T	Y	GT1020A	256TTFCD6076	✓	\$2,585	E1	91.0	25.8/12.9	368	25.89	75	A173A
	1200	575	256T	N	TE141	Century	✓	\$3,359	E1	91.0	11.0	350	27.84	d	WD250TCCFF2
	1200	575	256T	N	GT1120	256TTFCA6080	✓	\$2,585	E1	91.0	11.2	368	27.80	d, 75	A173
1200	575	256T	Y	GT1120A	256TTFCD6080	✓	\$2,585	E1	91.0	10.3	368	25.89	75	A173A	
15	3600	208-230/460	254T	N	TE153	Century	✓	\$2,718	E1	91.0	39-35/18	318	26.66	d	WD250TCCFF
	3600	230/460	254T	N	GT1021	254TTFCA6001	✓	\$1,990	E1	91.0	34.0/17.0	350	23.70	d, 75	A172
	3600	230/460	254T	Y	GT1021A	254TTFCD6001	✓	\$1,990	E1	91.0	35.5/17.8	393	24.15	75	A173A
	3600	575	254T	N	TE152	Century	✓	\$2,718	E1	91.0	14.0	317	26.66	d	WD250TCCFF
	3600	575	254T	N	GT1121	254TTFCA6005	✓	\$1,990	E1	91.0	13.6	350	26.60	d, 75	A172
	3600	575	254T	Y	GT1121A	254TTFCD6005	✓	\$1,990	E1	91.0	14.3	350	24.15	75	A173A
	1800	200	254T	N	TE151	Century	✓	\$2,552	E1	92.4	42.6	309	26.66		WD250TCCFF2
	1800	208-230/460	254T	N	TE149	Century	✓	\$2,552	E1	92.4	41-37/19	330	26.66	d	WD250TCCFF2
	1800	230/460	254T	N	GT1022	254TTFCA6026	✓	\$1,950	E1	92.4	37.0/18.5	375	23.70	d, 75	A173
	1800	230/460	254T	Y	GT1022A	254TTFCD6026	✓	\$1,950	E1	92.4	37.5/18.8	229	24.15	75	A173A
	1800	575	254T	N	TE150	Century	✓	\$2,552	E1	92.4	15.0	309	26.66	d	WD250TCCFF2
	1800	575	254T	N	GT1122	254TTFCA6030	✓	\$1,950	E1	92.4	14.8	375	26.60	d, 75	A173
	1800	575	254T	Y	GT1122A	254TTFCD6030	✓	\$1,950	E1	92.4	15.1	375	24.15	75	A173A
	1200	208-230/460	284T	N	TE147	Century	✓	\$4,370	E1	91.7	44-40/20	450	30.04	d	WD280TCCF4
	1200	230/460	284T	N	GT1023	284TTFCA6076	✓	\$3,275	E1	91.7	39.5/19.8	475	27.83	d	A175
	1200	230/460	284T	Y	GT1023A	284TTFCD6076	✓	\$3,275	E1	91.7	40.0/20.0	475	26.65		A175A
	1200	575	284T	N	TE148	Century	✓	\$4,370	E1	91.7	16.0	450	30.04	d	WD280TCCF4
	1200	575	284T	N	GT1123	284TTFCA6080	✓	\$3,275	E1	91.7	15.9	475	30.16	d	A175
1200	575	284T	Y	GT1123A	284TTFCD6080	✓	\$3,275	E1	91.7	16.0	475	26.65		A175A	
20	3600	208-230/460	256T	N	TE159	Century	✓	\$3,303	E1	91.0	52-47/23	344	27.84	d	WD250TCCFF
	3600	230/460	256T	N	GT1024	256TTFCA6001	✓	\$2,625	E1	91.0	46.0/23.0	375	27.80	d, 75	A172
	3600	230/460	256T	Y	GT1024A	256TTFCD6001	✓	\$2,625	E1	91.0	47.5/23.7	375	25.89		A173A
	3600	575	256T	N	TE160	Century	✓	\$3,303	E1	91.0	18.0	344	27.84	d	WD250TCCFF
	3600	575	256T	N	GT1124	256TTFCA6005	✓	\$2,625	E1	91.0	18.4	375	27.80	d, 75	A172
	3600	575	256T	Y	GT1124A	256TTFCD6005	✓	\$2,625	E1	91.0	19.0	375	25.89		A172A
	1800	200	256T	N	TE156	Century	✓	\$3,209	E1	93.0	55.8	350	31.22		WD250TCCFF2
	1800	208-230/460	256T	N	TE157	Century	✓	\$3,209	E1	93.0	54-49/24	374	27.84	d	WD250TCCFF2
	1800	230/460	256T	N	GT1025	256TTFCA6026	✓	\$2,454	E1	93.0	48.0/24.0	425	27.80	d, 75	A173
	1800	208-230/460	256T	Y	GT1025A	256TTFCD6026	✓	\$2,454	E1	93.0	53.0-48.5/24.2	335	25.89		A173A
	1800	575	256T	N	TE158	Century	✓	\$3,209	E1	93.0	19.0	378	27.84	d	WD250TCCFF2
	1800	575	256T	N	GT1125	256TTFCA6030	✓	\$2,454	E1	93.0	19.6	425	27.80	d, 75	A173
	1800	575	256T	Y	GT1125A	256TTFCD6030	✓	\$2,454	E1	93.0	19.4	425	25.89		A173A
	1200	208-230/460	286T	N	TE154	Century	✓	\$5,005	E1	91.7	58-52/26	527	31.22	d	WD280TCCF4
	1200	230/460	286T	N	GT1026	286TTFCA6076	✓	\$3,715	E1	91.7	52.0/26.0	550	27.83	d	A175
	1200	230/460	286T	Y	GT1026A	286TTFCD6076	✓	\$3,715	E1	91.7	52.0/26.0	550	28.14		A175A
	1200	575	286T	N	TE155	Century	✓	\$5,005	E1	91.7	21.0	509	31.22	d	WD280TCCF4
	1200	575	286T	N	GT1126	286TTFCA6080	✓	\$3,715	E1	91.7	20.8	550	31.34	d	A175
1200	575	286T	Y	GT1126A	286TTFCD6080	✓	\$3,715	E1	91.7	20.8	550	28.14		A175A	
25	3600	208-230/460	284TS	N	TE166	Century	✓	\$4,070	E1	91.7	63-57/28	510	28.67	d	WD280TCCF3
	3600	230/460	284TS	N	GT1027	284TSTFCA6001	✓	\$3,090	E1	91.7	55.5/27.7	475	28.82	d	A174
	3600	230/460	284TS	Y	GT1027A	284TSTFCD6001	✓	\$3,090	E1	91.7	60.0/30.0	386	25.28		A175A
	3600	575	284TS	N	TE167	Century	✓	\$4,070	E1	91.7	23.0	464	28.67	d	WD280TCCF3
	3600	575	284TS	N	GT1127	284TSTFCA6005	✓	\$3,090	E1	91.7	22.4	475	28.82	d	A174
	3600	575	284TS	Y	GT1127A	284TSTFCD6005	✓	\$3,090	E1	91.7	24.0	386	25.28		A175A
	1800	200	284T	N	TE163	Century	✓	\$3,748	E1	93.6	69.0	510	30.04		WD280TCCF4
	1800	208-230/460	284T	N	TE164	Century	✓	\$3,748	E1	93.6	67-60/30	510	30.04	d	WD280TCCF4
1800	230/460	284T	N	GT1028	284TTFCA6026	✓	\$2,890	E1	93.6	62.0/31.0	500	27.83	d	A175	

Catalog numbers (Cat No.) highlighted in bold blue are premium efficient.
Blue shaded areas are cast iron frames.

Continued on next page.

GLOBETROTTER® GENERAL PURPOSE MOTORS

THREE PHASE, TOTALLY ENCLOSED MOTORS

RIGID BASE

HP	RPM	VOLTS	FRAME	DIV. II & IP55	CAT NO.	MODEL NO.	STOCK	LIST PRICE	MULT. SYMB.	NOM. EFF.	FL. AMPS	WT.	"C" DIM	FOOT NOTES	C-FACE KITS	
25	1800	230/460	284T	Y	GT1028A	284TTFCD6026	✓	\$2,890	E1	93.6	61.0/30.5	400	26.65		A175A	
	1800	230/460	284TS	Y	GT1057	284TSTFC6026	✓	\$2,890	E1	93.6	61.0/30.5	400	25.28		A175A	
	1800	575	284T	N	TE165	Century®	✓	\$3,748	E1	93.6	24.0	510	30.04	d	WD280TCCF4	
	1800	575	284T	N	GT1128	284TTFCA6030	✓	\$2,890	E1	93.6	24.4	500	30.16	d	A175	
	1800	575	284T	Y	GT1128A	284TTFCD6030	✓	\$2,890	E1	93.6	24.3	500	26.65		A175A	
	1200	208-230/460	324T	N	TE161	Century	✓	\$6,584	E1	93.0	73.0-66.0/33.0	645	32.68	d	WD320TCCF	
	1200	230/460	324T	N	GT1029	324TTFCA6076	✓	\$5,204	E1	93.0	66.0/33.0	675	32.68	d	A177	
	1200	230/460	324T	Y	GT1029A	324TTFCD6076	✓	\$5,204	E1	93.0	64.0/32.0	675	29.69		A177A	
	1200	575	324T	N	TE162	Century	✓	\$6,584	E1	93.0	26.0	645	32.68	d	WD320TCCF	
	1200	575	324T	N	GT1129	324TTFCA6080	✓	\$5,204	E1	93.0	26.8	675	32.68	d	A177	
	1200	575	324T	Y	GT1129A	324TTFCD6080	✓	\$5,204	E1	93.0	25.6	675	29.69		A177A	
	30	3600	208-230/460	286TS	N	TE172	Century	✓	\$4,753	E1	91.7	75-68/34.0	535	29.85	d	WD280TCCF3
3600		230/460	286TS	N	GT1030	286TSTFCA6001	✓	\$3,404	E1	91.7	66.0/33.0	500	30.00	d	A174	
3600		230/460	286TS	Y	GT1030A	286TSTFCD6001	✓	\$3,404	E1	91.7	71.0/35.5	500	26.77		A175A	
3600		575	286TS	N	TE173	Century	✓	\$4,753	E1	91.7	27.0	501	29.85	d	WD280TCCF3	
3600		575	286TS	N	GT1130	286TSTFCA6005	✓	\$3,404	E1	91.7	27.2	500	30.00	d	A174	
3600		575	286TS	Y	GT1130A	286TSTFCD6005	✓	\$3,404	E1	91.7	28.5	500	26.77		A175A	
1800		208-230/460	286T	N	TE170	Century	✓	\$4,361	E1	93.6	80-72/36.0	566	31.22	d	WD280TCCF4	
1800		230/460	286T	N	GT1031	286TTFCA6026	✓	\$3,325	E1	93.6	73.0/36.5	525	27.83	d	A175	
1800		230/460	286T	Y	GT1031A	286TTFCD6026	✓	\$3,325	E1	93.6	72.5/36.5	492	28.14		A175A	
1800		230/460	286TS	Y	GT1058	286TSTFCD6026	✓	\$3,325	E1	93.6	72.5/36.5	492	26.77		A175A	
1800		575	286T	N	TE171	Century	✓	\$4,361	E1	93.6	29.0	523	31.22	d	WD280TCCF4	
1800		575	286T	N	GT1131	286TTFCA6030	✓	\$3,325	E1	93.6	29.2	525	31.34	d	A175	
1800		575	286T	Y	GT1131A	286TTFCD6030	✓	\$3,325	E1	93.6	29.1	492	28.14		A175A	
1200		208-230/460	326T	N	TE168	Century	✓	\$7,062	E1	93.0	88-79/40.0	735	33.86	d	WD320TCCF	
1200		230/460	326T	N	GT1032	326TTFCA6076	✓	\$5,704	E1	93.0	80.0/40.0	725	33.86	d	A177	
1200		230/460	326T	Y	GT1032A	326TTFCD6076	✓	\$5,704	E1	93.0	76.0/38.0	725	31.19		A177A	
1200		575	326T	N	TE169	Century	✓	\$7,062	E1	93.0	32.0	670	33.86	d	WD320TCCF	
1200		575	326T	N	GT1132	326TTFCA6080	✓	\$5,704	E1	93.0	32.0	725	33.86	d	A177	
1200		575	326T	Y	GT1132A	326TTFCD6080	✓	\$5,704	E1	93.0	30.5	725	31.19		A177A	
40		3600	208-230/460	324TS	N	TE177	Century	✓	\$6,268	E1	92.4	100-90/45.0	674	29.85	d	WD320TCCF2
		3600	230/460	324TS	N	GT1033	324TSTFCA6001	✓	\$4,791	E1	92.4	88.0/44.0	675	31.26	d	A176
		3600	230/460	324TS	Y	GT1033A	324TSTFCD6001	✓	\$4,791	E1	92.4	92.5/46.0	675	28.19		A177A
		3600	575	324TS	N	TE178	Century	✓	\$6,268	E1	92.4	36.0	616	31.18	d	WD320TCCF2
		3600	575	324TS	N	GT1133	324TSTFCA6005	✓	\$4,791	E1	92.4	35.0	675	31.26	d	A176
	3600	575	324TS	Y	GT1133A	324TSTFCD6005	✓	\$4,791	E1	92.4	37.0	675	28.19		A177A	
	1800	208-230/460	324T	N	TE175	Century	✓	\$5,736	E1	94.1	104-94/47	674	32.68	d	WD320TCCF	
	1800	230/460	324T	N	GT1034	324TTFCA6026	✓	\$4,538	E1	94.1	94.0/47.0	750	32.68	d	A177	
	1800	230/460	324T	Y	GT1034A	324TTFCD6026	✓	\$4,538	E1	94.1	95.0/47.5	750	29.69		A177A	
	1800	230/460	324TS	Y	GT1059	324TSTFCD6026	✓	\$4,538	E1	94.1	95.0/47.5	750	28.19		A177A	
	1800	575	324T	N	TE176	Century	✓	\$5,736	E1	94.1	37.0	646	32.68	d	WD320TCCF	
	1800	575	324T	N	GT1134	324TTFCA6030	✓	\$4,538	E1	94.1	37.5	750	32.68	d	A177	
	1800	575	324T	Y	GT1134A	324TTFCD6030	✓	\$4,538	E1	94.1	38.0	750	29.69		A177A	
	1200	208-230/460	364T	N	TE174	Century	✓	\$9,771	E1	94.1	105-95/47.0	830	36.61	d	WD360TCCF	
	1200	230/460	364T	N	GT1035	364TTFCA6086	✓	\$7,779	E1	94.1	94.0/47.0	950	36.61	d	A179	
	1200	230/460	364T	Y	GT1035A	364TTFCD6086	✓	\$7,779	E1	94.1	96.0/48.0	950	33.32		A179A	
	1200	575	364T	N	GT1135	364TTFCA6080	✓	\$7,779	E1	94.1	38.5	950	36.61	d	A179	
	1200	575	364T	Y	GT1135A	364TTFCD6080	✓	\$7,779	E1	94.1	38.5	950	33.32		A179A	
	50	3600	208-230/460	326TS	N	TE182	Century	✓	\$7,154	E1	93.0	124-112/56.0	719	32.36	d	WD320TCCF2
		3600	230/460	326TS	N	GT1036	326TSTFCA6001	✓	\$6,100	E1	93.0	109/54.5	725	32.44	d	A176
		3600	230/460	326TS	Y	GT1036A	326TSTFCD6001	✓	\$6,100	E1	93.0	113/56.5	725	29.69		A177A
		3600	575	326TS	N	TE183	Century	✓	\$7,154	E1	93.0	45.0	669	32.36	d	WD320TCCF2
		3600	575	326TS	N	GT1136	326TSTFCA6005	✓	\$6,100	E1	93.0	43.5	725	32.44	d	A176
		3600	575	326TS	Y	GT1136A	326TSTFCD6005	✓	\$6,100	E1	93.0	45.0	725	29.69		A177A
1800		208-230/460	326T	N	TE180	Century	✓	\$7,042	E1	94.5	132-119/60.0	725	33.86	d	WD320TCCF	
1800		230/460	326T	N	GT1037	326TTFCA6026	✓	\$5,532	E1	94.5	119/59.5	775	33.86	d	A177	
1800		230/460	326T	Y	GT1037A	326TTFCD6026	✓	\$5,532	E1	94.5	117/58.5	775	31.19		A177A	
1800		230/460	326TS	Y	GT1060	326TSTFCD6026	✓	\$5,532	E1	94.5	117/58.5	775	29.69		A177A	
1800		575	326T	N	TE181	Century	✓	\$7,042	E1	94.5	48.0	687	33.86	d	WD320TCCF	
1800		575	326T	N	GT1137	326TTFCA6030	✓	\$5,532	E1	94.5	47.5	775	33.86	d	A177	

Catalog numbers (Cat No.) highlighted in bold blue are premium efficient.

Blue shaded areas are cast iron frames.

Continued on next page.

GEN. PURPOSE THREE PHASE

GLOBETROTTER® GENERAL PURPOSE MOTORS

THREE PHASE, TOTALLY ENCLOSED MOTORS

RIGID BASE

HP	RPM	VOLTS	FRAME	DIV. II & IP55	CAT NO.	MODEL NO.	STOCK	LIST PRICE	MULT. SYMB.	NOM. EFF.	FL. AMPS	WT.	"C" DIM	FOOT NOTES	C-FACE KITS
50	1800	575	326T	Y	GT1137A	326TTFCD6030	√	\$5,532	E1	94.5	470	775	31.19		A177A
	1200	208-230/460	365T	N	TE179	Century®	√	\$11,106	E1	94.1	131-118/59.0	1,025	38.39	d	WD360TCCF
	1200	230/460	365T	N	GT1038	365TTFCA6086	√	\$8,841	E1	94.1	117/58.5	1000	38.39	d	A179
	1200	230/460	365T	Y	GT1038A	365TTFCD6086	√	\$8,841	E1	94.1	121/60.5	1000	34.30		A179A
	1200	575	365T	N	GT1138	365TTFCA6080	√	\$8,841	E1	94.1	470	1000	38.39	d	A179
	1200	575	365T	Y	GT1138A	365TTFCD6080	√	\$8,841	E1	94.1	48.5	1000	34.30		A179A
60	3600	208-230/460	364TS	N	TE188	Century	√	\$9,727	E1	93.6	149-135/67.0	942	34.09	d	WD360TCCF2
	3600	230/460	364TS	N	GT1039	364TTFCA6001	√	\$7,792	E1	93.6	132/66.0	925	34.57	d	A178
	3600	230/460	364TS	Y	GT1039A	364TTFCD6001	√	\$7,792	E1	93.6	135/67.5	925	31.19		A179A
	3600	575	364TS	N	GT1139	364TSTFCA6005	√	\$7,792	E1	93.6	53.0	925	34.57	d	A178
	3600	575	364TS	Y	GT1139A	364TSTFCD6005	√	\$7,792	E1	93.6	54.0	925	31.19		A179A
	1800	208-230/460	364T	N	TE185	Century	√	\$9,609	E1	95.0	152-138/69.0	993	36.61	d	WD360TCCF
	1800	230/460	364T	N	GT1040	364TTFCA6036	√	\$7,542	E1	95.0	138/69.0	1000	36.61	d	A179
	1800	230/460	364T	Y	GT1040A	364TTFCD6036	√	\$7,542	E1	95.0	138/69.0	1000	33.32		A179A
	1800	208-230/460	364TS	N	TE186	Century	√	\$9,609	E1	95.0	152-138/69.0	945	34.09	d	WD360TCCF
	1800	230/460	364TS	Y	GT1061	364TSTFCD6036	√	\$7,542	E1	95.0	138/69.0	1000	31.19		A179A
	1800	575	364T	N	TE187	Century	√	\$9,609	E1	95.0	55.0	987	36.22	d	WD360TCCF
	1800	575	364T	N	GT1140	364TTFCA6040	√	\$7,542	E1	95.0	55.0	1000	36.61	d	A179
	1800	575	364T	Y	GT1140A	364TTFCD6040	√	\$7,542	E1	95.0	55.0	1000	33.32		A179A
	1200	208-230/460	404T	N	TE184	Century	√	\$13,012	E1	94.5	158-143/72.0	1,340	42.06	d	WD400TCCF
	1200	230/460	404T	N	GT1041	404TTFCA6086	√	\$10,141	E1	94.5	140/70.0	1200	42.72	d	A425
	1200	230/460	404T	Y	GT1041A	404TTFCD6086	√	\$10,141	E1	94.5	143/71.5	1200	38.77		A425A
	1200	575	404T	N	GT1141	404TTFCA6080	√	\$10,141	E1	94.5	56.0	1200	42.72	d	A425
	1200	575	404T	Y	GT1141A	404TTFCD6080	√	\$10,141	E1	94.5	57.0	1200	38.77		A425A
75	3600	208-230/460	365TS	N	TE193	Century	√	\$12,081	E1	93.6	184-167/83.0	1,045	35.86	d	WD360TCCF2
	3600	230/460	365TS	N	GT1042	365TSTFCA6001	√	\$9,820	E1	93.6	164/82.0	1025	36.34	d	A178
	3600	230/460	365TS	Y	GT1042A	365TSTFCD6001	√	\$9,820	E1	94.1	168/84.0	1025	32.17		A179A
	3600	575	365TS	N	GT1142	365TSTFCA6002	√	\$9,820	E1	93.6	65.5	1025	36.34	d	A178
	3600	575	365TS	Y	GT1142A	365TSTFCD6002	√	\$9,820	E1	94.1	67.0	1025	32.17		A179A
	1800	208-230/460	365T	N	TE191	Century	√	\$11,805	E1	95.4	189-171/86.0	1,083	38.39	d	WD360TCCF
	1800	230/460	365T	N	GT1043	365TTFCA6036	√	\$9,402	E1	95.4	170/85.0	1100	38.39	d	A179
	1800	230/460	365T	Y	GT1043A	365TTFCD6036	√	\$9,402	E1	95.4	171/85.5	1100	34.30		A179A
	1800	208-230/460	365TS	N	TE190	Century	√	\$11,805	E1	95.4	189-171/86.0	1,045	35.86	d	WD360TCCF
	1800	230/460	365TS	Y	GT1062	365TSTFCD6036	√	\$9,402	E1	95.4	171/85.5	1100	32.17		A179A
	1800	575	365T	N	TE192	Century	√	\$11,805	E1	95.4	68.0	1,087	37.99	d	WD360TCCF
	1800	575	365T	N	GT1143	365TTFCA6040	√	\$9,402	E1	95.4	69.0	1100	38.39	d	A179
	1800	575	365T	Y	GT1143A	365TTFCD6040	√	\$9,402	E1	95.4	68.5	100	34.30		A179A
	1200	208-230/460	405T	N	TE189	Century	√	\$15,318	E1	94.5	196-177/88.0	1,436	42.06	d	WD400TCCF
	1200	230/460	405T	N	GT1044	405TTFCA6086	√	\$12,100	E1	94.5	174/87.0	1300	42.72	d	A425
	1200	230/460	405T	Y	GT1044A	405TTFCD6086	√	\$12,100	E1	94.5	178/89.0	1300	38.77		A425A
	1200	575	405T	N	GT1144	405TTFCA6080	√	\$12,100	E1	94.5	69.5	1300	42.72	d	A425
	1200	575	405T	Y	GT1144A	405TTFCD6080	√	\$12,100	E1	94.5	71.0	1300	38.77		A425A
100	3600	208-230/460	405TS	N	TE198	Century	√	\$14,657	E1	94.1	242-219/109	1,412	39.05	d	WD400TCCF2
	3600	230/460	405TS	N	GT1045	405TSTFCA6001	√	\$11,347	E1	94.1	216/108	1250	39.76	d	A424
	3600	230/460	405TS	Y	GT1045A	405TSTFCD6001	√	\$11,347	E1	94.5	222/111	1250	35.77		A424A
	3600	575	405TS	N	GT1145	405TSTFCA6005	√	\$11,347	E1	94.1	87.5	1250	39.76	d	A424
	3600	575	405TS	Y	GT1145A	405TSTFCD6005	√	\$11,347	E1	94.5	89.0	1250	35.77		A424A
	1800	208-230/460	405T	N	TE196	Century	√	\$14,429	E1	95.4	247-223/112	1,435	42.72	d	WD400TCCF
	1800	230/460	405T	N	GT1046	405TTFCA6036	√	\$11,192	E1	95.4	224/112	1375	42.72	d	A425
	1800	230/460	405T	Y	GT1046A	405TTFCD6036	√	\$11,192	E1	95.4	226/113	1375	38.77		A425A
	1800	208-230/460	405TS	N	TE197	Century	√	\$14,429	E1	95.4	247-223/112	1,435	39.05	d	WD400TCCF
	1800	230/460	405TS	Y	GT1063	405TSTFCD6036	√	\$11,192	E1	95.4	226/113	1375	35.77		A424A
	1800	575	405T	N	TE195	Century	√	\$14,429	E1	95.4	89.0	1,446	42.06	d	WD400TCCF
	1800	575	405T	N	GT1146	405TTFCA6040	√	\$11,192	E1	95.4	89.5	1375	42.72	d	A425
	1800	575	405T	Y	GT1146A	405TTFCD6040	√	\$11,192	E1	95.4	90.5	1375	38.77		A425A
	1200	208-230/460	444T	N	TE194	Century	√	\$22,588	E1	95.0	251-227/113	2,060	49.80	d	WD440TCF
	1200	230/460	444T	N	GT1047	444TTFCA6086	√	\$17,960	E1	95.0	228/114	2000	50.79	d	A427
	1200	230/460	444T	Y	GT1047A	444TTFCD6086	√	\$17,960	E1	95.0	229/115	2000	46.71		A427A
	1200	575	444T	N	GT1147	444TTFCA6080	√	\$17,960	E1	95.0	91.0	2000	50.79	d	A427
	1200	575	444T	Y	GT1147A	444TTFCD6080	√	\$17,960	E1	95.0	91.5	2000	46.71		A427A

Catalog numbers (Cat No.) highlighted in bold blue are premium efficient.
Blue shaded areas are cast iron frames.

Continued on next page.

GLOBETROTTER® GENERAL PURPOSE MOTORS

THREE PHASE, TOTALLY ENCLOSED MOTORS

RIGID BASE

HP	RPM	VOLTS	FRAME	DIV. II & IP55	CAT NO.	MODEL NO.	STOCK	LIST PRICE	MULT. SYMB.	NOM. EFF.	FL. AMPS	WT.	"C" DIM	FOOT NOTES	C-FACE KITS
125	3600	230/460	444TS	N	TE203	Century®	✓	\$20,472	E1	95.0	274/137	1925	46.05	d	WD440TCF2
	3600	460	444TS	N	GT1048	444TSTFC6001	✓	\$16,300	E1	95.0	136	1750	47.05	d	A426
	3600	460	444TS	Y	GT1048A	444TSTFCD6001	✓	\$16,300	E1	95.0	138	1750	42.96		A426A
	3600	575	444TS	N	GT1148	444TSTFC16002	✓	\$16,300	E1	95.0	109	1750	47.05	d	A426
	3600	575	444TS	Y	GT1148A	444TSTFCD16002	✓	\$16,300	E1	95.0	110	1750	42.96		A426A
	1800	230/460	444T	N	TE200	Century	✓	\$20,223	E1	95.4	279/139	1888	49.80	d	WD440TCF
	1800	460	444T	N	GT1049	444TTFC6036	✓	\$15,895	E1	95.4	140	1850	50.79	d	A427
	1800	460	444T	Y	GT1049A	444TTFCD6036	✓	\$15,895	E1	95.4	140	1850	46.71		A427A
	1800	230/460	444TS	N	TE201	Century	✓	\$20,223	E1	95.4	279/139	1888	46.05	d	WD440TCF
	1800	460	444TS	Y	GT1064	444TSTFCD6036	✓	\$15,895	E1	95.4	140	1850	42.96		A427A
	1800	575	444T	N	TE202	Century	✓	\$20,223	E1	95.4	112.0	1888	49.80	d	WD440TCF
	1800	575	444T	N	GT1149	444TTFC6044	✓	\$15,895	E1	95.4	112	1850	50.79	d	A427
	1800	575	444T	Y	GT1149A	444TTFCD6044	✓	\$15,895	E1	95.4	112	1850	46.71		A427A
	1200	230/460	445T	N	TE199	Century	✓	\$23,571	E1	95.0	287/143	2169	49.80	d	WD440TCF
	1200	460	445T	N	GT1050	445TTFC6086	✓	\$18,753	E1	95.0	142	2050	50.79	d	A427
	1200	460	445T	Y	GT1050A	445TTFCD6086	✓	\$18,753	E1	95.0	143	2050	46.71		A427A
	1200	575	445T	N	GT1150	445TTFC6080	✓	\$18,753	E1	95.0	114	2050	50.79	d	A427
	1200	575	445T	Y	GT1150A	445TTFCD6080	✓	\$18,753	E1	95.0	114	2050	46.71		A427A
150	3600	230/460	445TS	N	TE207	Century	✓	\$25,147	E1	95.0	329/164	2150	46.05	d	WD440TCF2
	3600	460	445TS	N	GT1051	445TSTFC6001	✓	\$18,995	E1	95.0	162	2050	47.05	d	A426
	3600	460	445TS	Y	GT1051A	445TSTFCD6001	✓	\$18,995	E1	95.0	167	2050	42.96		A426A
	3600	575	445TS	N	GT1151	445TSTFC6005	✓	\$18,995	E1	95.0	130	2050	47.05	d	A426
	3600	575	445TS	Y	GT1151A	445TSTFCD6005	✓	\$18,995	E1	95.0	131	2050	42.96		A426A
	1800	230/460	445T	N	TE205	Century	✓	\$23,747	E1	95.8	333/167	2161	49.80	d	WD440TCF
	1800	460	445T	N	GT1052	445TTFC6036	✓	\$17,994	E1	95.8	165	1880	50.79	d	A427
	1800	460	445T	Y	GT1052A	445TTFCD6036	✓	\$17,994	E1	95.8	169	1880	46.71		A427A
	1800	460	445TS	Y	GT1065	445TSTFCD6036	✓	\$17,994	E1	95.8	169	1880	42.96		A426A
	1800	575	445T	N	TE206	Century	✓	\$23,747	E1	95.8	133	2086	49.80	d	WD440TCF
	1800	575	445T	N	GT1152	445TTFC6037	✓	\$17,994	E1	95.8	132	1880	50.79	d	A427
	1800	575	445T	Y	GT1152A	445TTFCD6037	✓	\$17,994	E1	95.8	135	1880	46.71		A427A
	1200	230/460	447T	N	TE204	Century	✓	\$29,970	E1	95.8	337/169	2587	54.90	d	WD440TCF
	1200	460	447T	N	GT1053	447TTFC6087	✓	\$23,703	E1	95.8	170	2500	55.91	d	A429
	1200	460	447T	Y	GT1053A	447TTFCD6087	✓	\$23,703	E1	95.8	171	2500	55.21		A427A
	1200	575	447T	N	GT1153	447TTFC6080	✓	\$23,703	E1	95.8	136	2500	55.91	d	A429
	1200	575	447T	Y	GT1153A	447TTFCD6080	✓	\$23,703	E1	95.8	136	2500	55.21		A427A
	200	3600	230/460	447TS	N	TE211	Century	✓	\$29,365	E1	95.4	436/218	2580	51.16	d
3600		460	447TS	N	GT1054	447TSTFC16004	✓	\$22,900	E1	95.4	215	2300	52.17	d	A428
3600		460	447TS	Y	GT1054A	447TSTFCD6004	✓	\$22,900	E1	95.4	217	2300	51.46		A426A
3600		575	447TS	N	GT1154	447TSTFC6005	✓	\$22,900	E1	95.4	172	2300	52.17	d	A428
3600		575	447TS	Y	GT1154A	447TSTFCD6005	✓	\$22,900	E1	95.4	174	2300	51.46		A426A
1800		460	447T	N	TE209	Century	✓	\$28,881	E1	96.2	221	2461	54.90	d	WD440TCF
1800		460	447T	N	GT1055	447TTFC6038	✓	\$21,496	E1	96.2	225	2350	55.91	d, A, V	A429
1800		460	447T	Y	GT1055A	447TTFCD6038	✓	\$21,496	E1	96.2	219	2350	55.21		A427A
1800		460	447TS	Y	GT1066	447TSTFCD6038	✓	\$21,496	E1	96.2	219	2350	51.46		A427A
1800		575	447T	N	TE210	Century	✓	\$28,881	E1	96.2	177	2486	54.90	d	WD440TCF
1800		575	447T	N	GT1155	447TTFC6039	✓	\$21,496	E1	96.2	180	2350	55.91	d, V	A429
1800		575	447T	Y	GT1155A	447TTFCD6039	✓	\$21,496	E1	96.2	175	2350	55.21		A427A
1200		460	449T	N	TE208	Century	✓	\$31,918	E1	95.8	227	2650	54.90	d	WD440TCF
1200		460	449T	N	GT1056	449TTFC6088	✓	\$25,200	E1	95.8	228	2900	55.91	d, V	A429
1200		460	449T	Y	GT1056A	449TTFCD6088	✓	\$25,200	E1	95.8	227	2900	55.21		A427A
1200		575	449T	N	GT1156	449TTFC6080	✓	\$25,200	E1	95.8	182	2900	55.91	d, V	A429
1200		575	449T	Y	GT1156A	449TTFCD6080	✓	\$25,200	E1	95.8	182	2900	55.21		A427A

Catalog numbers (Cat No.) highlighted in bold blue are premium efficient.

Blue shaded areas are cast iron frames.

GEN. PURPOSE THREE PHASE

GLOBETROTTER® GENERAL PURPOSE MOTORS

THREE PHASE, TOTALLY ENCLOSED MOTORS

C-FACE FOOTLESS

HP	RPM	VOLTS	FRAME	IP55	DIV. II	CAT. NO.	MODEL NO.	STOCK	LIST PRICE	MULT. SYMB.	NOM. EFF.	FL. AMPS	WT.	"C" DIM.	FOOT NOTES	
1	1800	208-230/460	143TC	N	N	CF101	Century®	√	\$915	E1	85.5	3-2.7/1.4	53	13.70	d	
	1800	208-230/460	143TC	N	Y	GT1301	—	√	\$598	E1	85.5	3-2.7/1.4	53	13.70		
	1200	208-230/460	145TC	N	N	CF100	Century	√	\$1,308	E1	82.5	3.5-3.2/1.6	64	14.70	d	
	1200	208-230/460	145TC	N	Y	GT1302	—	√	\$678	E1	82.5	3.5-3.2/1.6	64	14.70		
1 1/2	3600	208-230/460	143TC	N	N	CF104	Century	√	\$1070	E1	84.0	4.3-3.9/1.9	56	13.70	d	
	3600	230/460	143TC	N	Y	GT1303	—	√	\$618	E1	84.0	3.9/1.9	56	13.70		
	1800	208-230/460	145TC	N	N	CF103	Century	√	\$1,017	E1	86.5	4.3-3.9/2	62	14.70	d	
	1800	230/460	145TC	N	Y	GT1304	—	√	\$695	E1	86.5	3.9/2.0	62	14.70		
	1200	208-230/460	182TC	N	N	CF102	Century	√	\$1,300	E1	87.5	5.1-4.7/2.3	91	15.75	d	
	1200	230/460	182TC	N	N	GT1305	182TTFB6079	√	\$813	E1	87.5	4.8/2.4	82	15.75	d	
	1200	230/460	182TC	N	Y	GT1305A	—	√	\$813	E1	87.5	4.8/2.4	82	15.75		
	2	3600	208-230/460	145TC	N	N	CF107	Century	√	\$1,179	E1	85.5	5.5-5/2.5	60	14.70	d
3600		230/460	145TC	N	Y	GT1306	—	√	\$719	E1	85.5	5.0/2.5	60	14.7		
1800		208-230/460	145TC	N	N	CF106	Century	√	\$1,119	E1	86.5	5.6-5.1/2.5	60	14.70	d	
1800		230/460	145TC	N	Y	GT1307	—	√	\$806	E1	86.5	5.0/2.5	60	14.70		
1200		208-230/460	184TC	N	N	CF105	Century	√	\$1,457	E1	88.5	6.7-6/3	112	16.73	d	
1200		208-230/460	184TC	N	N	GT1308	184TTFB6079	√	\$1,004	E1	88.5	6.0/3.0	94	16.73	d	
1200		230/460	184TC	N	Y	GT1308A	184TTFBD6079	√	\$1,004	E1	88.5	6.0/3.0	94	16.73		
3		3600	208-230/460	182TC	N	N	CF110	Century	√	\$1182	E1	86.5	8.4-7.6/3.8	88	15.75	d
	3600	208-230/460	182TC	N	N	GT1309	182TTFB6004	√	\$856	E1	86.5	7.6/3.8	83	15.75	d, A	
	3600	230/460	182TC	N	Y	GT1309A	182TTFBD6004	√	\$856	E1	86.5	7.6/3.8	83	15.75		
	1800	208-230/460	182TC	N	N	CF109	Century	√	\$1,168	E1	89.5	8.5-7.7/3.8	98	15.75	d	
	1800	208-230/460	182TC	N	N	GT1310	182TTFB6029	√	\$906	E1	89.5	7.8/3.9	87	15.75	d	
	1800	230/460	182TC	N	Y	GT1310A	182TTFBD6029	√	\$906	E1	89.5	7.8/3.9	87	15.75		
	1200	208-230/460	213TC	N	N	CF108	Century	√	\$1,728	E1	89.5	9.6-8.7/4.4	160	19.53	d	
	1200	208-230/460	213TC	N	N	GT1311	213TTFBA6079	√	\$1,224	E1	89.5	8.6/4.3	115	19.53	d	
	1200	230/460	213TC	N	N	GT1311A	213TTFBD6079	√	\$1,224	E1	89.5	8.6/4.3	115	19.53		
	5	3600	208-230/460	184TC	N	N	CF113	Century	√	\$1311	E1	88.5	14-12/6.2	101	16.73	d
3600		208-230/460	184TC	N	N	GT1312	184TTFB6004	√	\$998	E1	88.5	13.4/6.7	95	16.73	d, A	
3600		230/460	184TC	N	Y	GT1312A	184TTFBD6004	√	\$998	E1	88.5	13.4/6.7	95	16.73		
1800		208-230/460	184TC	N	N	CF112	Century	√	\$1,274	E1	89.5	14-13/6.3	110	16.73	d	
1800		208-230/460	184TC	N	N	GT1313	184TTFB6029	√	\$948	E1	89.5	12.4/6.2	110	16.73	d	
1800		230/460	184TC	N	Y	GT1313A	184TTFBD6029	√	\$948	E1	89.5	12.4/6.2	110	16.73		
1200		208-230/460	215TC	N	N	CF111	Century	√	\$2,162	E1	89.5	16-14/7.1	169	21.02	d	
1200		208-230/460	215TC	N	N	GT1314	215TTFBA6079	√	\$1,508	E1	89.5	14.0/7.0	135	21.02	d	
1200		230/460	215TC	N	N	GT1314A	215TTFBD6079	√	\$1,508	E1	89.5	13.6/6.8	135	21.02		
7 1/2		3600	208-230/460	213TC	N	N	CF116	Century	√	\$1,844	E1	89.5	20-18/9.2	151	19.53	d
	3600	208-230/460	213TC	N	N	GT1315	213TTFBA6004	√	\$1,131	E1	89.5	17.8/8.9	116	19.53	d	
	3600	230/460	213TC	N	N	GT1315A	213TTFBD6004	√	\$1,131	E1	89.5	18.4/9.2	242	19.53		
	1800	208-230/460	213TC	N	N	CF115	Century	√	\$1,482	E1	91.7	21-19/9.3	154	19.53	d	
	1800	230/460	213TC	N	N	GT1316	213TTFBA6029	√	\$1,081	E1	91.7	18.6/9.3	143	19.53	d	
	1800	230/460	213TC	N	N	GT1316A	213TTFBD6029	√	\$1,081	E1	91.7	19.0/9.5	153	19.53		
	1200	208-230/460	254TC	N	N	CF114	Century	√	\$2,712	E1	91.0	22-20/10	290	26.57	d	
	1200	230/460	254TC	Y	Y	GT1317	—	√	\$1,962	E1	91.0	20.0/10.0	290	26.57		
	10	3600	208-230/460	215TC	N	N	CF119	Century	√	\$1,948	E1	90.2	26-24/12	175	21.02	d
		3600	208-230/460	215TC	N	N	GT1318	215TTFBA6004	√	\$1,329	E1	90.2	22.8/11.4	137	21.02	d
3600		230/460	215TC	N	N	GT1318A	215TTFBD6004	√	\$1,329	E1	90.2	23.6/11.8	151	21.02		
1800		208-230/460	215TC	N	N	CF118	Century	√	\$1,898	E1	91.7	27-25/12	174	21.02	d	
1800		230/460	215TC	N	N	GT1319	215TTFBA6029	√	\$1,410	E1	91.7	24.4/12.2	164	21.02	d	
1800		230/460	215TC	N	N	GT1319A	215TTFBD6029	√	\$1,410	E1	91.7	25.0/12.5	165	21.02		
1200		208-230/460	256TC	N	N	CF117	Century	√	\$3,225	E1	91.0	30-27/14	295	27.76	d	
1200		230/460	256TC	Y	Y	GT1320	—	√	\$2,458	E1	91.0	27.0/14.0	295	27.76		

Catalog numbers (Cat No.) highlighted in bold blue are premium efficient.

Blue shaded areas are cast iron frames.

GLOBETROTTER® GENERAL PURPOSE MOTORS

THREE PHASE, TOTALLY ENCLOSED MOTORS

C-FACE FOOTED (RIGID BASE)

HP	RPM	VOLTS	FRAME	IP55	DIV. II	CAT. NO.	MODEL NO.	STOCK	LIST PRICE	MULT. SYMB.	NOM. EFF.	FL. AMPS	WT.	"C" DIM.	FOOT NOTES	
1	1800	208-230/460	143TC	N	N	CFR02	Century®	✓	\$701	E1	85.5	3-2.7/1.4	53	13.70	d	
	1800	230/460	143TC	N	N	GT1201	143TTFR6032	✓	\$598	E1	85.5	3.3/1.65	42	13.87	d	
	1800	230/460	143TC	N	Y	GT1201A	—	✓	\$598	E1	85.5	3.3/1.65	42	13.87		
	1800	575	143TC	N	N	GT1401	143TTFR16039	✓	\$598	E1	85.5	1.3	42	13.87	d, A	
	1800	575	143TC	N	Y	GT1401A	—	✓	\$598	E1	85.5	1.3	42	13.87		
	1200	208-230/460	145TC	N	N	CFR01	Century	✓	\$918	E1	82.5	3.5-3.2/1.6	64	14.70	d	
	1200	208-230/460	145TC	N	N	GT1202	145TTFR16079	✓	\$783	E1	82.5	3.8-3.8/1.9	49	14.87	d	
	1200	208-230/460	145TC	N	Y	GT1202A	—	✓	\$783	E1	82.5	3.8-3.8/1.9	49	14.87		
	1 1/2	3600	208-230/460	143TC	N	N	CFR05	Century	✓	\$748	E1	84.0	4.3-3.9/1.9	56	13.70	d
		3600	230/460	143TC	N	N	GT1203	143TTFR6010	✓	\$638	E1	84.0	4.0/2.0	39	13.87	d
3600		230/460	143TC	N	Y	GT1203A	—	✓	\$638	E1	84.0	4.0/2.0	39	13.87		
3600		575	143TC	N	N	GT1403	143TTFR16003	✓	\$638	E1	84.0	1.6	39	13.37	d	
3600		575	143TC	N	Y	GT1403A	—	✓	\$638	E1	84.0	1.6	39	13.37		
1800		208-230/460	145TC	N	N	CFR04	Century	✓	\$711	E1	86.5	4.3-4/2.0	62	14.70	d	
1800		230/460	145TC	N	N	GT1204	145TTFR6058	✓	\$606	E1	86.5	4.6/2.3	44	14.37	d	
1800		230/460	145TC	N	Y	GT1204A	—	✓	\$606	E1	86.5	4.6/2.3	44	14.37		
1800		575	145TC	N	N	GT1404	145TTFR16046	✓	\$606	E1	86.5	2.0	44	14.37	d, A	
1800		575	145TC	N	Y	GT1404A	—	✓	\$606	E1	86.5	2.0	44	14.37		
1200		208-230/460	182TC	N	N	CFR03	Century	✓	\$1,028	E1	87.5	5.1-4.7/2.3	91	15.75	d	
1200		230/460	182TC	N	N	GT1205	182TTFB6078	✓	\$833	E1	87.5	4.8/2.4	91	15.75	d	
1200		230/460	182TC	N	Y	GT1205A	182TTFBD6078	✓	\$833	E1	87.5	4.8/2.4	91	15.75		
2		3600	208-230/460	145TC	N	N	CFR08	Century	✓	\$819	E1	85.5	5.5-5/2.5	60	14.70	d
		3600	208-230/460	145TC	N	N	GT1206	145TTFR6009	✓	\$699	E1	85.5	5.6-5.2/2.6	46	14.37	d
		3600	230/460	145TC	N	Y	GT1206A	—	✓	\$699	E1	85.5	5.2/2.6	46	14.37	
	3600	575	145TC	N	N	GT1406	145TTFR16005	✓	\$699	E1	85.5	2.0	46	14.37	d	
	3600	575	145TC	N	Y	GT1406A	—	✓	\$699	E1	85.5	2.0	46	14.37		
	1800	208-230/460	145TC	N	N	CFR07	Century	✓	\$762	E1	86.5	5.6-5.1/2.5	60	14.70	d	
	1800	230/460	145TC	N	N	GT1207	145TTFR6040	✓	\$650	E1	86.5	6.0/3.0	49	14.87	d, A	
	1800	230/460	145TC	N	Y	GT1207A	—	✓	\$650	E1	86.5	6.0/3.0	49	14.87		
	1800	575	145TC	N	N	GT1407	145TTFR16047	✓	\$650	E1	86.5	2.4	49	14.87	d, A	
	1800	575	145TC	N	Y	GT1407A	—	✓	\$650	E1	86.5	2.4	49	14.87		
	1200	208-230/460	184TC	N	N	CFR06	Century	✓	\$1,177	E1	88.5	6.7-6/3	104	16.73	d	
	1200	230/460	184TC	N	N	GT1208	184TTFB6078	✓	\$1,004	E1	88.5	6.0/3.0	104	16.73	d	
	1200	230/460	184TC	N	Y	GT1208A	184TTFBD6078	✓	\$1,004	E1	88.5	6.0/3.0	104	16.73		
	3	3600	208-230/460	182TC	N	N	CFR11	Century	✓	\$1085	E1	86.5	8.4-7.6/3.8	83	15.75	d
		3600	230/460	182TC	N	N	GT1209	182TTFB6003	✓	\$886	E1	86.5	7.6/3.8	83	15.75	d
		3600	230/460	184TC	N	Y	GT1209A	182TTFBD6003	✓	\$886	E1	86.5	7.6/3.8	83	15.75	
3600		575	182TC	N	N	GT1409	182TTFB6007	✓	\$886	E1	86.5	3.0	83	15.75	d	
3600		575	184TC	N	Y	GT1409A	182TTFBD6007	✓	\$886	E1	86.5	3.0	83	15.75		
1800		208-230/460	182TC	N	N	CFR10	Century	✓	\$1,022	E1	89.5	8.3-7.5/3.8	92	15.75	d	
1800		230/460	182TC	N	N	GT1210	182TTFB6028	✓	\$836	E1	89.5	7.8/3.9	105	15.75	d	
1800		230/460	184TC	N	Y	GT1210A	182TTFBD6028	✓	\$836	E1	89.5	7.8/3.9	105	15.75		
1800		575	182TC	N	N	GT1410	182TTFB6032	✓	\$871	E1	89.5	3.1	108	15.75	d	
1800		575	184TC	N	Y	GT1410A	182TTFBD6032	✓	\$871	E1	89.5	3.1	108	15.75		
1200		208-230/460	213TC	N	N	CFR09	Century	✓	\$1,435	E1	89.5	9.4-8.5/4.3	164	19.53	d	
1200		230/460	213TC	N	N	GT1211	213TTFBA6078	✓	\$1,253	E1	89.5	8.6/4.3	164	19.53	d	
1200		230/460	213TC	N	Y	GT1211A	213TTFBA6078	✓	\$1,253	E1	89.5	8.6/4.3	164	19.53		
5		3600	208-230/460	184TC	N	N	CFR14	Century	✓	\$1,258	E1	88.5	13-12/6	97	16.73	d
	3600	230/460	184TC	N	N	GT1212	184TTFB6003	✓	\$1,028	E1	88.5	13.4/6.7	97	16.73	d	
	3600	230/460	184TC	N	Y	GT1212A	184TTFBD6003	✓	\$1,028	E1	88.5	13.4/6.7	97	16.73		
	3600	575	184TC	N	N	GT1412	184TTFB6007	✓	\$1,028	E1	88.5	4.8	97	16.73	d	
	3600	575	184TC	N	Y	GT1412A	184TTFBD6007	✓	\$1,028	E1	88.5	4.8	97	16.73		
	1800	208-230/460	184TC	N	N	CFR13	Century	✓	\$1,136	E1	89.5	14-13/6.3	105	16.73	d	
	1800	230/460	184TC	N	N	GT1213	184TTFB6028	✓	\$978	E1	89.5	12.4/6.2	105	16.73	d	
	1800	230/460	184TC	N	Y	GT1213A	184TTFBD6028	✓	\$978	E1	89.5	12.4/6.2	105	16.73		
	1800	575	184TC	N	N	GT1413	184TTFB6032	✓	\$978	E1	89.5	5.1	105	16.73	d	
	1800	575	184TC	N	Y	GT1413A	184TTFBD6032	✓	\$978	E1	89.5	5.1	105	16.73		
	1200	208-230/460	215TC	N	N	CFR12	Century	✓	\$1,849	E1	89.5	16-14/7.1	174	21.02	d	
	1200	230/460	215TC	N	N	GT1214	215TTFBA6078	✓	\$1,538	E1	89.5	14.0/7.0	174	21.02	d	
	1200	230/460	215TC	N	Y	GT1214A	215TTFBD6078	✓	\$1,538	E1	89.5	13.6/6.8	185	21.02		

Catalog numbers (Cat No.) highlighted in bold blue are premium efficient.

Continued on next page.

GLOBETROTTER® GENERAL PURPOSE MOTORS

THREE PHASE, TOTALLY ENCLOSED MOTORS

C-FACE FOOTED (RIGID BASE)

HP	RPM	VOLTS	FRAME	IP55	DIV. II	CAT. NO.	MODEL NO.	STOCK	LIST PRICE	MULT. SYMB.	NOM. EFF.	FL. AMPS	WT.	"C" DIM.	FOOT NOTES	
7 1/2	3600	208-230/460	213TC	N	N	CFR17	Century®	√	\$1,545	E1	89.5	20-10/9.2	152	19.53	d	
	3600	230/460	213TC	N	N	GT1215	213TTFBA6003	√	\$1,155	E1	89.5	17.8/8.9	152	19.53	A	
	3600	230/460	213TC	N	Y	GT1215A	213TTFBD6003	√	\$1,155	E1	89.5	18.4/9.2	136	19.53		
	3600	575	213TC	N	N	GT1415	213TTFBA6007	√	\$1,155	E1	89.5	7.1	152	19.53	d	
	3600	575	213TC	N	Y	GT1415A	213TTFBD6007	√	\$1,155	E1	89.5	7.4	138	19.53		
	1800	208-230/460	213TC	N	N	CFR16	Century	√	\$1,473	E1	91.7	21-19/9.6	161	19.53	d	
	1800	230/460	213TC	N	N	GT1216	213TTFBA6028	√	\$1,256	E1	91.7	18.6/9.3	161	19.53	d	
	1800	230/460	213TC	N	Y	GT1216A	213TTFBD6028	√	\$1,256	E1	91.7	19/9.5	158	19.53		
	1800	575	213TC	N	N	GT1416	213TTFBA6032	√	\$1,111	E1	91.7	8.6	161	19.53	d	
	1800	575	213TC	N	Y	GT1416A	213TTFBD6032	√	\$1,111	E1	91.7	7.6	157	19.53		
1200	208-230/460	254TC	N	N	CFR15	Century	√	\$2,851	E1	91.0	23-21/10	315	26.60	d		
	230/460	254TC	N	N	GT1217	254TTFCA6078	√	\$2,206	E1	91.0	20.4/10.2	315	26.60	d		
	230/460	254TC	Y	Y	GT1217A	254TTFCD6078	√	\$2,206	E1	91.0	19.8/9.9	315	24.65			
10	3600	208-230/460	215TC	N	N	CFR20	Century	√	\$1,727	E1	90.2	26-24/12	172	21.02	d	
	3600	230/460	215TC	N	N	GT1218	215TTFBA6003	√	\$1,454	E1	90.2	22.8/11.4	172	21.02	d	
	3600	230/460	215TC	N	Y	GT1218A	215TTFBD6003	√	\$1,454	E1	90.2	23.6/11.8	155	21.02		
	3600	575	215TC	N	N	GT1418	215TTFBA6007	√	\$1,454	E1	90.2	9.4	172	21.02	d	
	3600	575	215TC	N	Y	GT1418A	215TTFBD6007	√	\$1,454	E1	90.2	9.5	172	21.02		
	1800	208-230/460	215TC	N	N	CFR19	Century	√	\$1,676	E1	91.7	27-25/12	183	21.02	d	
	1800	230/460	215TC	N	N	GT1219	215TTFBA6028	√	\$1,401	E1	91.7	24.4/12.2	183	21.02	d	
	1800	230/460	215TC	N	Y	GT1219A	215TTFBD6028	√	\$1,401	E1	91.7	25/12.5	175	21.02		
	1800	575	215TC	N	N	GT1419	215TTFBA6032	√	\$1,401	E1	91.7	10.7	183	21.02	d	
	1800	575	215TC	N	Y	GT1419A	215TTFBD6032	√	\$1,401	E1	91.7	10.0	186	21.02		
1200	208-230/460	256TC	N	N	CFR18	Century	√	\$3,420	E1	91.0	30-27/14.0	345	27.80	d		
	230/460	256TC	N	N	GT1220	256TTFCA6078	√	\$2,665	E1	91.0	28.0/14.0	345	27.80	d		
	230/460	256TC	Y	Y	GT1220A	256TTFCD6078	√	\$2,665	E1	91.0	25.8/12.9	345	27.80	d		
15	3600	208-230/460	254TC	N	N	CFR23	Century	√	\$2,857	E1	91.0	39-35/18.0	336	26.60	d	
	3600	230/460	254TC	N	N	GT1221	254TTFCA6003	√	\$2,011	E1	91.0	34.0/17.0	336	26.60	d	
	3600	230/460	254TC	Y	Y	GT1221A	254TTFCD6003	√	\$2,011	E1	91.0	35.5/17.8	336	24.65		
	3600	575	254TC	N	N	GT1421	254TTFCA6007	√	\$2,011	E1	91.0	14.2	336	26.60	d	
	3600	575	254TC	Y	Y	GT1421A	254TTFCD6007	√	\$2,011	E1	91.0	14.3	336	24.65		
	1800	208-230/460	254TC	N	N	CFR22	Century	√	\$2,752	E1	92.4	41-37/19	325	26.60	d	
	1800	230/460	254TC	N	N	GT1222	254TTFCA6028	√	\$1,961	E1	92.4	37.0/18.5	325	26.60	d	
	1800	230/460	254TC	Y	Y	GT1222A	254TTFCD6028	√	\$1,961	E1	92.4	37.5/18.8	311	24.65		
	1800	575	254TC	N	N	GT1422	254TTFCA6032	√	\$1,961	E1	92.4	15.8	325	26.60	d	
	1800	575	254TC	Y	Y	GT1422A	254TTFCD6032	√	\$1,961	E1	92.4	15.1	325	24.65		
1200	208-230/460	284TC	N	N	CFR21	Century	√	\$4,586	E1	91.7	45-41/20.0	450	30.04	d		
	230/460	284TC	Y	Y	GT1223	—	√	\$3,705	E1	91.7	41.0/20.0	450	30.04	YD		
20	3600	208-230/460	256TC	N	N	CFR26	Century	√	\$3,369	E1	91.0	51-46/23.0	364	27.80	d	
	3600	230/460	256TC	N	N	GT1224	256TTFCA6003	√	\$2,665	E1	91.0	46.0/23.0	375	27.80	d	
	3600	230/460	256TC	Y	Y	GT1224A	256TTFCD6003	√	\$2,665	E1	91.0	47.5/23.7	123	26.39		
	1800	208-230/460	256TC	N	N	CFR25	Century	√	\$3,291	E1	93.0	54-49/24.0	414	27.80	d	
	1800	230/460	256TC	N	N	GT1225	256TTFCA6028	√	\$2,554	E1	93.0	49.0/24.5	425	27.80	d	
	1800	230/460	256TC	Y	Y	GT1225A	256TTFCD6028	√	\$2,554	E1	93.0	48.5/24.2	330	26.39		
	1200	208-230/460	286TC	N	N	CFR24	Century	√	\$5,204	E1	91.7	58-52/26.0	530	31.22	d	
	1200	230/460	286TC	Y	Y	GT1226	—	√	\$4,205	E1	91.7	52.0/26.0	530	31.22	YD	
	25	3600	208-230/460	284TSC	N	N	CFR29	Century	√	\$4,251	E1	91.7	63-57/28.0	490	28.67	d
		3600	230/460	284TSC	N	N	GT1227	284TSTFCA6003	√	\$3,198	E1	91.7	56.0/28.0	475	28.79	d, YD
3600		230/460	284TSC	Y	Y	GT1227A	284TSTFCD6003	√	\$3,198	E1	91.7	60.0/30.0	293	25.28	YD	
1800		208-230/460	284TC	N	N	CFR28	Century	√	\$3,919	E1	93.6	68-61/31	510	30.04	d	
1800		230/460	284TC	N	N	GT1228	284TTFCA6028	√	\$2,971	E1	93.6	61.0/30.5	500	30.16	d, YD	
1800		230/460	284TC	Y	Y	GT1228A	284TTFCD6028	√	\$2,971	E1	93.6	61.0/30.5	500	26.65	YD	
1200		208-230/460	324TC	N	N	CFR27	Century	√	\$6,531	E1	93.0	74-67/33	645	32.68	d	
1200		230/460	324TC	Y	Y	GT1229	—	√	\$5,277	E1	93.0	67.0/33.0	645	32.68	YD	

Catalog numbers (Cat No.) highlighted in bold blue are premium efficient.

Blue shaded areas are cast iron frames.

Continued on next page.

GLOBETROTTER® GENERAL PURPOSE MOTORS

THREE PHASE, TOTALLY ENCLOSED MOTORS

C-FACE FOOTED (RIGID BASE)

HP	RPM	VOLTS	FRAME	IP55	DIV. II	CAT. NO.	MODEL NO.	STOCK	LIST PRICE	MULT. SYMB.	NOM. EFF.	FL. AMPS	WT.	"C" DIM.	FOOT NOTES
30	3600	208-230/460	286TSC	N	N	CFR32	Century®	√	\$4,889	E1	91.7	75-68/34	516	29.85	d
	3600	230/460	286TSC	N	N	GT1230	286TSTFCA6003	√	\$3,529	E1	91.7	68.0/34.0	500	39.97	d, YD
	3600	230/460	286TSC	Y	Y	GT1230A	286TSTFCD6003	√	\$3,529	E1	91.7	71.0/35.5	500	26.77	YD
	1800	208-230/460	286TC	N	N	CFR31	Century	√	\$4,707	E1	93.6	81-73/37	541	31.22	d
	1800	230/460	286TC	N	N	GT1231	286TTFCA6028	√	\$3,450	E1	93.6	73.0/36.5	525	31.34	d, YD
	1800	230/460	286TC	Y	Y	GT1231A	286TTFCD6028	√	\$3,450	E1	93.6	72.5/36.5	504	26.77	YD
	1200	208-230/460	326TC	N	N	CFR30	Century	√	\$6,911	E1	93.0	88-79/40	730	33.86	d
	1200	230/460	326TC	Y	Y	GT1232	—	√	\$5,584	E1	93.0	79.0/40.0	730	33.86	YD
40	3600	208-230/460	324TSC	N	N	CFR35	Century	√	\$6,502	E1	92.4	100-90/45	647	31.18	d
	3600	230/460	324TSC	N	N	GT1233	324TSTFCA6003	√	\$4,998	E1	92.4	88.0/44.0	675	31.18	d, YD
	3600	230/460	324TSC	Y	Y	GT1233A	324TSTFCD6003	√	\$4,998	E1	92.4	92.5/46.0	675	28.19	YD
	1800	208-230/460	324TC	N	N	CFR34	Century	√	\$6,005	E1	94.1	106-96/48	665	32.68	d
	1800	230/460	324TC	N	N	GT1234	324TTFCA6028	√	\$4,643	E1	94.1	94.0/47.0	750	32.68	d, YD
	1800	230/460	324TC	Y	Y	GT1234A	324TTFCD6028	√	\$4,643	E1	94.1	95.0/47.5	750	29.69	YD
	1200	208-230/460	364TC	N	N	CFR33	Century	√	\$9,749	E1	94.5	107-97/48	900	36.22	d
	1200	230/460	364TC	Y	Y	GT1235	—	√	\$7,877	E1	94.5	97.0/48.0	900	36.22	YD
50	3600	208-230/460	326TSC	N	N	CFR38	Century	√	\$7,973	E1	93.0	124-112/56	704	32.36	d
	3600	230/460	326TSC	N	N	GT1236	326TSTFCA6003	√	\$6,398	E1	93.0	109/54.5	725	32.36	d, YD
	3600	230/460	326TSC	Y	Y	GT1236A	326TSTFCD6003	√	\$6,398	E1	93.0	113/56.5	725	29.69	YD
	1800	208-230/460	326TC	N	N	CFR37	Century	√	\$7,371	E1	94.5	132-119/60	702	33.86	d
	1800	230/460	326TC	N	N	GT1237	326TTFCA6028	√	\$5,798	E1	94.5	119/59.5	775	33.86	d, YD
	1800	230/460	326TC	Y	Y	GT1237A	326TTFCD6028	√	\$5,798	E1	94.5	117/58.5	775	1.63	YD
	1200	208-230/460	365TC	N	N	CFR36	Century	√	\$10,386	E1	94.1	131-118/59	1040	37.99	d
	1200	230/460	365TC	Y	Y	GT1238	—	√	\$8,392	E1	94.1	118/59.0	1040	37.99	YD
60	3600	208-230/460	364TSC	N	N	CFR41	Century	√	\$10,573	E1	93.6	149-135/67	974	34.09	d
	3600	230/460	364TSC	N	N	GT1239	364TSTFCA6003	√	\$8,116	E1	93.6	132/66.0	925	34.48	d, YD
	3600	230/460	364TSC	Y	Y	GT1239A	364TSTFCD6003	√	\$8,116	E1	93.6	135/67.5	925	31.19	YD
	1800	208-230/460	364TC	N	N	CFR40	Century	√	\$10,064	E1	95.0	152-138/69	1023	36.22	d
	1800	230/460	364TC	N	N	GT1240	364TTFCA6038	√	\$7,911	E1	95.0	138/69.0	1000	36.61	d, YD
	1800	230/460	364TC	Y	Y	GT1240A	364TTFCD6038	√	\$7,911	E1	95.0	138/69.0	1000	33.32	YD
	1200	208-230/460	404TC	N	N	CFR39	Century	√	\$13,047	E1	94.5	158-143/72	1360	42.06	d
	1200	230/460	404TC	Y	Y	GT1241	—	√	\$10,542	E1	94.5	143/72.0	1360	42.06	YD
75	3600	208-230/460	365TSC	N	N	CFR44	Century	√	\$12,370	E1	93.6	188-170/85	1084	35.86	d
	3600	230/460	365TSC	N	N	GT1242	365TSTFCA6003	√	\$10,079	E1	93.6	164/82.0	1025	36.26	d, YD
	3600	230/460	365TSC	Y	Y	GT1242A	365TSTFCD6003	√	\$10,079	E1	93.6	168/84.0	1025	32.17	YD
	1800	208-230/460	365TC	N	N	CFR43	Century	√	\$12,126	E1	95.4	191-173/86	1126	37.99	d
	1800	230/460	365TC	N	N	GT1243	365TTFCA6038	√	\$9,679	E1	95.4	173/86.5	1100	38.39	d, YD
	1800	230/460	365TC	Y	Y	GT1243A	365TTFCD6038	√	\$9,679	E1	95.4	171/85.5	1100	34.30	YD
	1200	208-230/460	405TC	N	N	CFR42	Century	√	\$14,220	E1	94.5	196-177/88	1450	42.06	d
	1200	230/460	405TC	Y	Y	GT1244	—	√	\$11,489	E1	94.5	177/88.0	1450	42.06	YD
100	3600	230/460	405TSC	N	N	GT1245	405TSTFC6003	√	\$11,870	E1	94.1	224/112	1250	39.76	d, YD
	3600	230/460	405TSC	Y	Y	GT1245A	405TSTFCD6003	√	\$11,870	E1	94.1	222/111	1250	35.77	YD
	1800	230/460	405TC	N	N	GT1246	405TTFC6038	√	\$11,712	E1	95.4	224/112	1375	42.76	d, YD
	1800	230/460	405TC	Y	Y	GT1246A	405TTFCD6038	√	\$11,712	E1	95.4	226/113	1375	38.77	YD

Catalog numbers (Cat No.) highlighted in bold blue are premium efficient.

Blue shaded areas are cast iron frames.

SEVERE DUTY, TOTALLY ENCLOSED MOTORS

WET ENVIRONMENT / CAR WASH
C-FACE FOOTLESS, THREE PHASE MOTORS

FEATURES:

- 303 Stainless steel shafts with contact lip seal & V-ring slinger
- Rolled steel construction
- Gray epoxy paint
- Class F insulation
- 1.15 service factor (except as noted)
- Automatic thermal protection



IP55



SEVERE DUTY

HP	RPM	VOLTS	FRAME	CAT. NO.	MODEL NO.	STOCK	LIST PRICE	MULT. SYMB.	NOM. EFF.	F.L. AMPS	WT.	"C" DIM.	FOOT NOTES
1/2	1800	230/460	56C	K606	5K42GN4619	√	\$752	F3	72.0	2.2/1.1	30	11.19	
3/4	1800	230/460	56C	K607	5K49MN4620	√	\$826	F3	77.0	3.0/1.5	30	11.69	
1	1800	230/460	56C	K608A	056T17W99021	√	\$972	F3	85.5	3.2/1.6	36	12.87	
1 1/2	1800	230/460	56C	K610A	056T17W99024	√	\$1,015	F3	86.5	4.8/2.4	42	13.37	
2	1800	230/460	56C	K609	5K49TN4622	√	\$1,015	F3	81.5	6.2/3.1	38	12.69	d, 17
	1800	230/460	56C	K609A	056T17W99023	√	\$1,152	F3	86.5	5.8/2.9	45	13.87	17

BLUE CHIP SERIES® SEVERE DUTY MOTORS

COOLING TOWER: SINGLE-SPEED
RIGID BASE, THREE PHASE MOTORS

FEATURES:

- Blue Chip Series quality, 100% cast iron construction for rigidity and reduced vibration
- Internal and external epoxy paint
- Class F insulation
- 1.15 service factor
- Rated 60/50 hertz, 190/380 or 380 volt at next lower horsepower
- Extended grease tubes, regreasable in service
- T-drains provided for effective drainage (Installed in both endshields)
- Suitable for shaft down mounting
- Shaft slinger
- Forsheda® seals on both ends
- Ball bearings
- Actual test and vibration data supplied with each motor
- UL recognized and CSA certified
- Suitable for 10:1 VT and CT (as noted) on VFD
- Three year warranty



IP55



HP	RPM	VOLTS	FRAME	CAT. NO.	MODEL NO.	STOCK	CT SPEED RANGE*	LIST PRICE	MULT. SYMB.	NOM. EFF.	F.L. AMPS	WT.	"C" DIM.	FOOT NOTES
3	1800	230/460	182T	U867A	182TTFN6557		10:1	\$1,571	S3	90.2	8.0/4.0	145	15.87	
5	1800	230/460	184T	U868A	184TTFN6555	√	10:1	\$1,718	S3	90.2	12.4/6.2	128	17.87	
7 1/2	1800	230/460	213T	U869A	213TTFN6550	√	10:1	\$2,168	S3	91.7	19.2/9.6	273	18.22	
10	1800	230/460	215T	U870A	215TTFN6546	√	10:1	\$2,483	S3	91.7	25/12.5	267	19.72	
15	1800	230/460	254T	U871A	254TTFNA16568	√	10:1	\$3,203	S3	92.4	37.5/18.8	349	23.52	
20	1800	230/460	256T	U872A	256TTFNA16574	√	10:1	\$3,766	S3	93.0	48.0/24.1	375	25.27	
25	1800	230/460	284T	U873A	284TTFNA16832	√	10:1	\$4,464	S3	93.6	62.0/31.0	440	26.34	
30	1800	230/460	286T	U874A	286TTFNA16572	√	10:1	\$5,224	S3	94.1	73.0/36.5	503	27.84	
40	1800	230/460	324T	U875A	324TTFN16837	√	2:1	\$6,772	S3	94.1	95.0/47.5	567	30.37	
50	1800	230/460	326T	U876A	326TTFN16574	√	2:1	\$8,369	S3	94.5	120.0/60.0	644	30.37	
60	1800	230/460	364T	U877A	364TTFN16558	√	2:1	\$11,936	S3	95.0	138.0/69.0	1078	31.50	
75	1800	230/460	365T	U878A	365TTFN16827	√	2:1	\$14,859	S3	95.4	172.0/86.0	1169	32.50	
100	1800	230/460	405T	U879A	405TTFN16834	√	2:1	\$18,400	S3	95.4	226.0/113.0	1458	37.12	
125	1800	460	444T	U880A	444TTFN16549	√	2:1	\$23,688	S3	95.4	145.0	1990	43.35	
150	1800	460	445T	U881A	445TTFN16866		2:1	\$28,206	S3	95.8	172.0	2343	43.35	
200	1800	460	445T	U882A	445TTFN16852		2:1	\$28,315	S3	96.2	226.0	2556	43.35	
250	1800	460	445T	U884A	449TTFN36649		2:1	\$45,331	S3	96.5	285.0	2409	51.84	

Catalog numbers (Cat No.) highlighted in bold blue are premium efficient.
Blue shaded areas are cast iron frames.

* Requires nameplate modification.

Forsheda is believed to be the trademark or trade name of Trelleborg Forsheda Sweden AB and is not owned or controlled by Regal Beloit Corporation.

Prices and specifications are subject to change without notice.

BLUE CHIP SERIES® SEVERE DUTY MOTORS

COOLING TOWER: SINGLE-SPEED
TEAO, RIGID BASE, THREE PHASE MOTORS

FEATURES:

- Meets or exceeds NEMA Premium® efficiencies
- Bearing Current Protection (BCP)
- Blue Chip Series® quality, 100% cast iron construction for rigidity and reduced vibration
- Internal and external epoxy paint
- MAX GUARD® motor Class F insulation system
- 1.15 service factor on sinewave, 1.0 service factor on IGBT power
- Rated 60/50 hertz, 190/380 or 380 volt at next lower horsepower
- Extended grease tubes, regreasable in service
- T-drains provided for effective drainage (Installed in both endshields)
- Suitable for all angle mounting
- Inpro/Seal® quality VBX® bearing isolators
- Ball bearings
- Actual test and vibration data supplied with each motor
- UL recognized and CSA certified
- Suitable for 10:1 VT and 20:1 CT on VFD
- Three year warranty



HP	RPM	VOLTS	FRAME	CAT. NO.	MODEL NO.	STOCK	CT SPEED RANGE	LIST PRICE	MULT. SYMB.	NOM. EFF.	FL. AMPS	WT.	"C" DIM.	FOOT NOTES
3	1800	230/460	182T	U1867	182TTN16571	✓	20:1	\$1,957	S3	90.2	8.0/4.0	124	13.74	
5	1800	230/460	184T	U1868	184TTN16545	✓	20:1	\$2,270	S3	90.2	12.4/6.2	144	15.74	
7 1/2	1800	230/460	213T	U1869	213TTN16539	✓	20:1	\$2,781	S3	91.7	19.2/9.6	212	17.51	
10	1800	230/460	215T	U1870	215TTN16541	✓	20:1	\$3,348	S3	91.7	25.0/12.5	245	20.51	
15	1800	230/460	254T	U1871	254TTN16545	✓	20:1	\$3,983	S3	92.4	37.5/18.8	309	20.61	
20	1800	230/460	256T	U1872	256TTN16544	✓	20:1	\$4,963	S3	93.0	48.0/24.1	363	22.35	
25	1800	230/460	284T	U1873	284TTN16540	✓	20:1	\$5,906	S3	93.6	62.0/31.0	443	23.42	
30	1800	230/460	286T	U1874	286TTN16541	✓	20:1	\$6,871	S3	94.1	73.0/36.5	473	24.92	
40	1800	230/460	324T	U1875	324TTS16535	✓	20:1	\$9,124	S3	94.1	95.0/47.5	637	27.72	
50	1800	230/460	326T	U1876	326TTS16533	✓	20:1	\$11,212	S3	94.5	120/60.0	732	27.72	
60	1800	230/460	364T	U1877	364TTS16534	✓	20:1	\$14,792	S3	95.0	138/69.0	862	29.64	
75	1800	230/460	365T	U1878	365TTS16536	✓	20:1	\$18,752	S3	95.4	172/86.0	930	29.89	
100	1800	230/460	405T	U1879	405TTS16537	✓	20:1	\$23,167	S3	95.4	226/113	1162	34.31	
125	1800	460	444T	U1880	444TTN16535	✓	20:1	\$30,498	S3	95.4	143	1748	40.05	
150	1800	460	445T	U1881	445TTN16536	✓	20:1	\$34,530	S3	95.8	172	1670	40.05	
200	1800	460	445T	U1882	445TTN16537	✓	20:1	\$42,094	S3	96.2	224	2042	40.05	
250	1800	460	447/449T	U1884	449TTS16539	✓	20:1	\$51,032	S3	96.5	285	2409	48.49	

Catalog numbers (Cat No.) highlighted in bold blue are premium efficient.

Blue shaded areas are cast iron frames.

Inpro/Seal and VBX are believed to be the trademarks or trade names of INPRO/SEAL LLC and are not controlled by Regal Beloit Corporation.

NEMA Premium is a trademark of National Electrical Manufacturers Association. All Rights Reserved.

BLUE CHIP SERIES® SEVERE DUTY / AUTOMOTIVE DUTY MOTORS

NEMA PREMIUM® XRI® MOTORS
TOTALLY ENCLOSED , THREE PHASE



SEVERE DUTY

APPLICATIONS

Chemical plants, paper mills, refineries, mines, food processing, foundries, and other severe duty environments where long life and ultra-high efficiency are desired. Guaranteed efficiencies offer an eXtra Return on your Investment when using these premium efficiency motors on high cycle or long run applications.

FEATURES:

Meets or exceeds NEMA Premium® efficiencies;

NEMA Premium models are in compliance with EISA 2007

- Bearing Current Protection (BCP), as noted
- Blue Chip Series® quality, 100% cast iron construction for rigidity and reduced vibration
- Provisions to add stub shaft for an encoder (182T-449T, TEFC only)
- Internal and external epoxy paint
- MAX GUARD® motor Class F insulation system
- Constant torque speed range is listed in CT speed range column
- 1.15 service factor on sinewave, 1.0 service factor on IGBT power
- Bearing caps (254T and larger)
- Precision balanced to .08"/sec
- Extended grease tubes, regreasable in service
- Brass drain and breather
- Meets IEEE45 USCG Marine Duty, IP54 construction

- Meets Ford® EM1 automotive duty specification
- **BCP (-P) models are not Hazardous Duty® motors certified for Division 2 locations**
- Hazardous Duty® motor Division 2 CSA certification nameplate
- Division 2 / Zone 2 Class I (gases), Groups A, B, C, D
- Meets temperature code T2B
- Actual test and vibration data supplied with each motor
- Ball bearings (except as noted)
- UL recognized (through 449T) and CSA certified and CE mark
- Three year warranty

MODELS THROUGH 40 HP ARE CAPABLE OF MODIFICATION AS FOLLOWS (CONTACT FACTORY TO CONFIRM):

- 1.25 service factor (sinewave only)
- Any nameplate changes are subject to modification charges (see MOD Central section)
- 50Hz at same HP, 1.0 service factor (sinewave only)
- Contact your sales representative for optional nameplate markings on 50 HP and larger

RIGID BASE

HP	RPM	VOLTS	FRAME	CAT. NO.	MODEL NO.	STOCK	CT SPEED RANGE*	LIST PRICE	MULT. SYMB.	NOM. EFF.	FL. AMPS	WT.	"C" DIM.	FOOT NOTES	C-FACE KITS
3/4	1200	460	143T	E648	143TTTN6576	√	1000:1	\$750	E9	80.0	1.4	53	10.43	75, 76, N, NE	A603
	1200	460	143T	E373	143TTFN6576		20:1	\$825	E9	80.0	1.4	53	12.92	75, 76, NE	A603
1	1800	460	143T	E649	143TTTN6526	√	1000:1	\$750	E9	85.5	1.5	55	10.43	75, 76, N	A603
	1800	460	143T	E374	143TTFN6526		20:1	\$750	E9	85.5	1.5	71	12.92	75, 76	A603
	1800	230/460	143T	E461	143TTTN6563	√	1000:1	\$750	E9	85.5	3.1/1.5	55	12.95	75, 76, N	A603
	1800	230/460	143T	E375	143TTFN6563		20:1	\$750	E9	85.5	3.1/1.5	71	12.95	75, 76	A603
	1800	575	143T	E666	143TTTN6530	√	1000:1	\$750	E9	85.5	1.2	55	10.43	75, 76, N	A603
	1800	575	143T	E376	143TTFN6539		20:1	\$750	E9	85.5	1.2	71	14.17	75, 76	A603
	1200	460	145T	E650A	—		1000:1	\$861	E9	82.5	1.7	75	11.43	75, 76, N	A655
	1200	460	145T	E858	145TTFN16593	√	20:1	\$861	E9	82.5	1.8	71	14.17	75, 76	A603
	1200	230/460	145T	E462A	145TTTN16584		1000:1	\$861	E9	82.5	3.3/1.65	60	11.43	75, 76, N	A655
	1200	230/460	145T	E499	145TTFN16592		20:1	\$861	E9	82.5	3.6/1.8	69	14.17	75, 76	A603
1 1/2	3600	460	143T	E651	143TTTN6501	√	1000:1	\$825	E9	86.5	2.0	58	10.43	75, 76, N	A603
	3600	460	143T	E377	143TTFN6501		20:1	\$841	E9	85.5	2.0	64	14.17	75, 76	A603
	3600	230/460	143T	E463	143TTTN6502		1000:1	\$825	E9	86.5	4.0/2.0	58	10.43	75, 76, N	A603
	3600	230/460	143T	E378	143TTFN6502		20:1	\$841	E9	85.5	4.0/2.0	64	14.17	75, 76	A603
	3600	575	143T	E851	143TTTN6505		1000:1	\$825	E9	86.5	1.6	58	10.43	75,76,N	A603
	3600	575	143T	E379	143TTFN6505		20:1	\$841	E9	85.5	1.6	64	14.17	75, 76, N	A603
	1800	460	145T	E652A	145TTTN16630	√	1000:1	\$810	E9	86.5	2.3	65	11.43	75, 76, N	A655
	1800	230/460	145T	E464A	145TTTN16631	√	1000:1	\$810	E9	86.5	4.6/2.3	65	11.43	75, 76, N	A655
	1800	575	145T	E667A	145TTTN16637		1000:1	\$810	E9	86.5	1.8	65	11.43	75, 76, N	A655
	1200	460	182T	E632	182TTTS6576	√	1000:1	\$985	E9	87.5	2.2	100	12.71	75, N	A644
	1200	460	182T	E380A	182TTFN16584		20:1	\$1,084	E9	87.5	2.2	110	15.19	75	A644
	1200	230/460	182T	E465	182TTTS6578		1000:1	\$985	E9	87.5	4.4/2.2	100	12.71	75, N	A644

Catalog numbers (Cat No.) highlighted in bold blue are premium efficient.

* Requires nameplate modification.

Blue shaded areas are cast iron frames.

Ford is believed to be the trademark or trade name of Ford Motor Company and is not controlled by Regal Beloit Corporation.

NEMA Premium is a trademark of National Electrical Manufacturers Association. All Rights Reserved.

Prices and specifications are subject to change without notice.

BLUE CHIP SERIES® SEVERE DUTY / AUTOMOTIVE DUTY MOTORS

NEMA PREMIUM® XRI® MOTORS

TOTALLY ENCLOSED, RIGID BASE, THREE PHASE

SEVERE DUTY

HP	RPM	VOLTS	FRAME	CAT. NO.	MODEL NO.	STOCK	CT SPEED RANGE*	LIST PRICE	MULT. SYMB.	NOM. EFF.	FL. AMPS	WT.	"C" DIM.	FOOT NOTES	C-FACE KITS
2	3600	460	145T	E653	145TTTN6501	√	1000:1	\$860	E9	85.5	2.5	68	11.43	75, 76, N	A655
	3600	460	145T	E382	145TTFN6501		20:1	\$884	E9	85.5	2.0	80	14.17	75, 76	A655
	3600	230/460	145T	E466	145TTTN6521		1000:1	\$860	E9	85.5	5.0/2.5	68	11.43	75, 76, N	A655
	3600	230/460	145T	E383	145TTFN6521		20:1	\$884	E9	85.5	4.0/2.0	80	14.17	75, 76	A655
	3600	575	145T	E852	145TTTN6505		1000:1	\$860	E9	85.5	2.0	68	11.43	75, 76, N	A655
	1800	460	145T	E654A	145TTTN16629	√	1000:1	\$850	E9	86.5	3.0	65	11.43	N, 75, 76	A655
	1800	230/460	145T	E467A	145TTTN16628	√	1000:1	\$850	E9	86.5	6.0/3.0	65	11.43	N, 75, 76	A655
	1800	230/460	145T	E386A	145TTFN16632		20:1	\$850	E9	86.5	6.0/3.0	76	14.17	75, 76	A655
	1800	575	145T	E668A	145TTTN16632		1000:1	\$850	E9	86.5	2.4	65	11.43	N, 75, 76	A655
	1200	460	184T	E633	184TTTS6576	√	1000:1	\$1,218	E9	88.5	3.0	112	13.71	75, N	A644
	1200	460	184T	E388A	184TTFN6576		20:1	\$1,339	E9	88.5	3.0	171	17.87	75	A641
	1200	230/460	184T	E468	184TTTS6582	√	1000:1	\$1,218	E9	88.5	6.0/3.0	112	13.71	75, N	A644
3	3600	460	182T	E601	182TTTS6501	√	1000:1	\$1,103	E9	87.5	3.8	98	12.71	75, N	A644
	3600	230/460	182T	E390	182TTF6501		20:1	\$1,214	E9	87.5	3.8	105	15.19	75	A644
	3600	575	182T	E853	182TTTS6505		1000:1	\$1,103	E9	87.5	3.0	105	12.71	75, N	A644
	3600	575	182T	E392	182TTF6505		20:1	\$1,214	E9	87.5	3.0	105	21.57	75	A644
	1800	460	182T	E616	182TTTS6526	√	1000:1	\$989	E9	90.2	4.0	102	12.71	75, N	A644
	1800	230/460	182T	E470	182TTTS6538	√	1000:1	\$989	E9	90.2	8.0/4.0	102	12.71	75, N	A644
	1800	575	182T	E669	182TTTS6530	√	1000:1	\$989	E9	90.2	3.2	102	12.71	75, N	A644
	1200	460	213T	E634	213TTF6576	√	20:1	\$1,499	E9	89.5	4.4	176	18.22	d, 75	A206
	1200	460	213T	E634A	213TTFND6576	√	20:1	\$1,499	E9	89.5	4.4	208	19.63	75	A646
	5	3600	460	184T	E602	184TTF6501	√	2:1	\$1,225	E9	89.5	5.9	142	16.19	75
3600		230/460	184T	E472	184TTF6810	√	2:1	\$1,225	E9	89.5	11.8/5.9	142	16.19	75	A644
3600		575	184T	E655	184TTF6505	√	20:1	\$1,225	E9	89.5	4.7	142	16.19	75	A644
1800		460	184T	E617	184TTF6526	√	20:1	\$1,146	E9	90.2	6.2	130	16.19	75	A644
1800		230/460	184T	E473	184TTF6844	√	20:1	\$1,146	E9	90.2	12.4/6.2	130	16.19	75	A644
1800		575	184T	E670	184TTF6530	√	20:1	\$1,146	E9	90.2	5.0	130	16.19	75	A644
1200		460	215T	E635	215TTF6576	√	20:1	\$1,841	E9	89.5	6.9	202	19.72	75	A206
1200		460	215T	E635A	215TTFND6576	√	20:1	\$1,841	E9	89.5	6.9	202	19.63	75	A646
1200		230/460	215T	E474	215TTF6881	√	20:1	\$1,841	E9	89.5	13.8/6.9	202	19.72	d, 75	A206
1200		230/460	215T	E474A	215TTFND6881	√	20:1	\$1,841	E9	89.5	13.8/6.9	215	19.63	75	A646
1200		575	215T	E683	215TTF6580		20:1	\$1,841	E9	89.5	5.5	202	19.72	d, 75	A206
7 1/2		3600	460	213T	E603	213TTTS6501	√	1000:1	\$1,480	E9	91.7	8.9	200	17.19	d, 75, N
	3600	460	213T	E603A	—	√	1000:1	\$1,480	E9	91.7	8.9	200	17.19	75	A646
	3600	460	213T	E396	213TTF6501		2:1	\$1,480	E9	89.5	8.9	175	19.72	d, 75	A206
	3600	230/460	213T	E475	213TTTS6502	√	1000:1	\$1,480	E9	91.7	17.8/8.9	200	17.19	d, 75, N	A206
	3600	230/460	213T	E475A	—	√	1000:1	\$1,480	E9	91.7	17.8/8.9	200	17.19	75, N	A646
	3600	575	213T	E656	213TTTS6505	√	1000:1	\$1,480	E9	91.7	7.1	200	17.19	75, N	A206
	1800	460	213T	E618	213TTF6526	√	20:1	\$1,405	E9	91.7	9.6	200	19.72	d, 75	A206
	1800	460	213T	E618A	213TTFND6526	√	20:1	\$1,405	E9	91.7	9.6	225	19.63	75	A646
	1800	230/460	213T	E476	213TTF6531	√	20:1	\$1,405	E9	91.7	19.2/9.6	200	19.72	d, 75	A206
	1800	230/460	213T	E476A	213TTFND6531	√	20:1	\$1,405	E9	91.7	19.2/9.6	220	19.63	75	A646
	1800	575	213T	E671	213TTF6530	√	20:1	\$1,405	E9	91.7	7.7	200	19.72	d, 75	A206
	1800	575	213T	E671A	213TTFND6530	√	20:1	\$1,405	E9	91.7	7.7	221	19.63	75	A646
	1200	460	254T	E636	254TTFNA6576	√	20:1	\$2,386	E9	91.0	9.9	326	23.52	75	A284
	1200	230/460	254T	E477	254TTFNA6590	√	20:1	\$2,386	E9	91.0	19.8/9.9	326	23.52	75	A284
	1200	575	254T	E684	254TTFNA6578		20:1	\$2,386	E9	91.0	7.9	326	23.52	75	A284
	10	3600	460	215T	E604A	215TTFND6501	√	2:1	\$1,728	E9	91.7	11.9	215	19.63	75
3600		230/460	215T	E478	215TTF6807	√	2:1	\$1,728	E9	91.7	23.6/11.8	218	19.72	75	A206
3600		575	215T	E657	215TTF6505		2:1	\$1,728	E9	91.7	9.5	218	19.72	75	A206
1800		460	215T	E619	215TTF6526	√	20:1	\$1,691	E9	91.7	12.5	225	19.72	d, 75	A206
1800		460	215T	E619A	215TTFND6526	√	20:11	\$1,691	E9	91.7	13.3	240	19.63	75	A646
1800		230/460	215T	E479	215TTF6527	√	20:1	\$1,691	E9	91.7	25.0/12.5	225	19.72	d, 75	A206
1800		230/460	215T	E479A	215TTFND6527	√	20:1	\$1,691	E9	91.7	26.6/13.13	252	22.63	75	A646
1800		230/460	215T	E479-P	215TTFN16847	√	20:1	\$2,003	E9	91.7	25.0/12.5	254	22.63	75, P	A646
1800		575	215T	E672	215TTF6530	√	20:1	\$1,691	E9	91.7	10.0	225	19.72	d, 75	A206
1800		575	215T	E672A	215TTFND6530	√	20:1	\$1,691	E9	91.7	10.7	175	22.63	75	A646
1200		460	256T	E637	256TTFNA6576	√	20:1	\$2,914	E9	91.0	13.1	405	25.27	75	A284
1200		230/460	256T	E480	256TTFNA6596	√	20:1	\$2,914	E9	91.0	26.2/13.1	405	25.27	75	A284
1200		575	256T	E685	256TTFNA6578		20:1	\$2,914	E9	91.0	10.5	405	25.27	75	A284

Catalog numbers (Cat No.) highlighted in bold blue are premium efficient.

* Requires nameplate modification.

Continued on next page.

Blue shaded areas are cast iron frames.

NEMA Premium is a trademark of National Electrical Manufacturers Association. All Rights Reserved.

BLUE CHIP SERIES® SEVERE DUTY / AUTOMOTIVE DUTY MOTORS

NEMA PREMIUM® XRI® MOTORS

TOTALLY ENCLOSED, RIGID BASE, THREE PHASE

SEVERE DUTY

HP	RPM	VOLTS	FRAME	CAT. NO.	MODEL NO.	STOCK	CT SPEED RANGE*	LIST PRICE	MULT. SYMB.	NOM. EFF.	FL. AMPS	WT.	"C" DIM.	FOOT NOTES	C-FACE KITS	
15	3600	460	254T	E605	254TTFNA6501	√	2:1	\$2,315	E9	91.7	17.5	345	23.52	75	A284	
	3600	230/460	254T	E481	254TTFNA6515	√	2:1	\$2,315	E9	91.7	35.0/17.5	345	23.52	75	A284	
	3600	575	254T	E658	254TTFNA6503		2:1	\$2,315	E9	91.7	14.2	345	23.52	75	A284	
	1800	460	254T	E620	254TTFNA6526	√	20:1	\$2,173	E9	92.4	18.8	350	23.52	75	A284	
	1800	460	254T	E620-P	254TTFNA16838	√	20:1	\$2,390	E9	92.4	18.8	330	23.52	75	A284	
	1800	230/460	254T	E482	254TTFNA6529	√	20:1	\$2,173	E9	92.4	37.6/18.8	350	23.52	75	A284	
	1800	575	254T	E673	254TTFNA6528	√	20:1	\$2,173	E9	92.4	15.0	350	23.52	75	A284	
	1200	460	284T	E638	284TTFNA6576	√	20:1	\$3,870	E9	91.7	20.4	479	26.34		A618	
	1200	230/460	284T	E483	284TTFNA6876	√	20:1	\$3,870	E9	91.7	40.8/20.4	479	26.34		A618	
	1200	575	284T	E694	284TTFNA6580	√	20:1	\$3,870	E9	91.7	16.3	479	26.34		A618	
20	3600	460	256T	E606	256TTFNA6501	√	2:1	\$2,868	E9	92.4	23.4	375	25.27	75	A284	
	3600	230/460	256T	E484	256TTFNA6523		2:1	\$2,868	E9	92.4	47.0/23.4	375	25.27	75	A284	
	3600	575	256T	E659	256TTFNA6503	√	2:1	\$2,868	E9	92.4	18.7	375	25.27	75	A284	
	1800	460	256T	E621	256TTFNA6526	√	20:1	\$2,708	E9	93.0	24.1	425	25.27	75	A284	
	1800	460	256T	E621-P	256TTFNA16855	√	20:1	\$2,979	E9	93.0	24.1	425	25.27	75, P	A284	
	1800	230/460	256T	E485	256TTFNA6529	√	20:1	\$2,708	E9	93.0	48.2/24.1	425	25.27	75	A284	
	1800	575	256T	E674	256TTFNA6528	√	20:1	\$2,708	E9	93.0	19.3	425	25.27	75	A284	
	1200	460	286T	E639	286TTFNA6576	√	20:1	\$4,714	E9	91.7	26.8	550	27.84		A618	
	1200	230/460	286T	E486	286TTFNA6876		20:1	\$4,714	E9	91.7	53.5/26.8	550	27.84		A618	
	1200	575	286T	E695	286TTFNA6580		20:1	\$4,714	E9	91.7	21.4	550	27.84		A618	
25	3600	460	284TS	E607	284TSTFNA6501	√	2:1	\$3,533	E9	93.6	28.1	481	24.97		A618	
	3600	575	284TS	E660	284TSTFNA6502		2:1	\$3,533	E9	93.6	22.5	481	24.97		A618	
	1800	460	284T	E622	284TTFNA6526	√	20:1	\$3,224	E9	93.6	31.0	478	26.34		A618	
	1800	460	284T	E622-P	284TTFNA16851	√	20:1	\$3,546	E9	93.6	31.0	478	26.34	P	A618	
	1800	230/460	284T	E488	284TTFNA6837	√	20:1	\$3,224	E9	93.6	62.0/31.0	478	26.34		A618	
	1800	575	284T	E675	284TTFNA6527	√	20:1	\$3,224	E9	93.6	24.8	478	26.34		A618	
	1200	460	324T	E640	324TTFS6576	√	20:1	\$5,714	E9	93.0	32.5	675	28.87		A214	
	1200	575	324T	E696	324TTFS6577		20:1	\$5,714	E9	93.0	26.0	675	28.87		A214	
	30	3600	460	286TS	E608	286TSTFNA6501	√	2:1	\$4,125	E9	93.6	34.1	500	26.47		A618
		3600	230/460	286TS	E490	286TSTFNA6804	√	2:1	\$4,125	E9	93.6	67.5/34.0	500	26.47		A618
1800		460	286T	E623	286TTFNA6526	√	20:1	\$3,749	E9	94.1	36.5	525	27.84		A618	
1800		460	286T	E623-P	286TTFNA16847	√	20:1	\$4,124	E9	94.1	36.5	525	27.84	P	A618	
1800		230/460	286T	E491	286TTFNA6570	√	20:1	\$3,749	E9	94.1	73.0/36.5	525	27.84		A618	
1800		575	286T	E676	286TTFNA6527	√	20:1	\$3,749	E9	94.1	29.2	525	27.84		A618	
1200		460	326T	E641	326TTFS6576	√	20:1	\$6,583	E9	93.0	38.5	725	30.37		A214	
1200		575	326T	E400	326TTFS6580		20:1	\$6,583	E9	93.0	31.0	725	30.37		A214	
40		3600	460	324TS	E609	324TSTFS6501	√	2:1	\$5,441	E9	93.6	47.0	656	27.37		A214
		3600	575	324TS	E662	324TSTFS6505		2:1	\$5,441	E9	93.6	37.5	656	27.37		A214
	1800	460	324T	E624	324TTFS6526	√	2:1	\$4,979	E9	94.1	47.5	700	30.37		A214	
	1800	460	324T	E624-P	324TTFS16860	√	2:1	\$5,476	E9	94.1	47.5	700	30.37	P	A214	
	1800	575	324T	E677	324TTFS6527	√	2:1	\$4,979	E9	94.1	38.0	700	30.37		A214	
	1200	460	364T	E642A	364TTFS16584	√	2:1	\$9,588	E9	94.1	50.0	882	31.50		A395	
	1200	575	364T	E401A	364TTFS16585		2:1	\$9,588	E9	94.1	40.0	882	31.50		A395	
	50	3600	460	326TS	E610	326TSTFS6501	√	2:1	\$7,039	E9	93.6	58.0	725	28.87		A214
		3600	575	326TS	E663	326TSTFS6502		2:1	\$7,039	E9	93.6	46.5	725	28.87		A214
		1800	460	326T	E625	326TTFS6526	√	2:1	\$6,115	E9	94.5	60.0	775	31.87		A214
1800		460	326T	E625-P	326TTFS16844	√	2:1	\$6,726	E9	94.5	60.0	775	31.87	P	A214	
1800		460	326TS	E453	326TSTFS6536		2:1	\$6,115	E9	94.5	60.0	775	28.87		A214	
1800		575	326T	E678	326TTFS6527	√	2:1	\$6,115	E9	94.5	48.0	775	30.37		A214	
1200		460	365T	E643A	365TTFS16591	√	2:1	\$10,779	E9	94.1	61.5	946	32.50		A395	
1200		575	365T	E402A	365TTFS16592		2:1	\$10,779	E9	94.1	49.0	946	32.50		A395	
60		3600	460	364TS	E611	364TSTFS6501	√	2:1	\$9,259	E9	94.5	67.0	954	29.38		A396
		3600	575	364TS	E664	364TSTFS6505		2:1	\$9,259	E9	94.5	53.5	954	29.38		A396
	1800	460	364T	E626	364TTFS6536	√	2:1	\$8,773	E9	95.0	69.0	980	31.50		A395	
	1800	460	364T	E626-P	364TTFS16833	√	2:1	\$11,301	E9	95.0	69.0	980	31.50	P	A395	
	1800	460	364TS	E454	364TSTFS6526		2:1	\$8,773	E9	95.0	69.0	980	29.38		A396	
	1800	575	364T	E679	364TTFS6537	√	2:1	\$8,773	E9	95.0	55.0	980	31.50		A395	
	1200	460	404T	E644	404TTFS6586	√	2:1	\$12,003	E9	94.5	72.0	1156	35.62		A223	
	1200	575	404T	E403	404TTFS6592		2:1	\$12,003	E9	94.5	57.5	1156	35.62		A223	

Catalog numbers (Cat No.) highlighted in bold blue are premium efficient.

Blue shaded areas are cast iron frames.

* Requires nameplate modification.

Continued on next page.

BLUE CHIP SERIES® SEVERE DUTY / AUTOMOTIVE DUTY MOTORS

NEMA PREMIUM® XRI® MOTORS

TOTALLY ENCLOSED, RIGID BASE, THREE PHASE

SEVERE DUTY

HP	RPM	VOLTS	FRAME	CAT. NO.	MODEL NO.	STOCK	CT SPEED RANGE*	LIST PRICE	MULT. SYMB.	NOM. EFF.	FL. AMPS	WT.	"C" DIM.	FOOT NOTES	C-FACE KITS
75	3600	460	365TS	E612	365TSTFS6501	√	2:1	\$11,628	E9	94.5	84.0	1002	30.38		A396
	3600	575	365TS	E665	365TSTFS6502	√	2:1	\$11,628	E9	94.5	67.0	1002	30.38		A396
	1800	460	365T	E627	365TTFS6536	√	2:1	\$11,120	E9	95.4	86.0	1100	32.50		A395
	1800	460	365T	E627-P	365TTFS16862	√	2:1	\$13,344	E9	95.4	86.0	1100	32.50	P	A395
	1800	460	365TS	E455	365TSTFS6526	√	2:1	\$11,120	E9	95.4	86.0	1100	30.38		A396
	1800	575	365T	E680	365TTFS6537	√	2:1	\$11,120	E9	95.4	69.0	1100	32.50		A395
	1200	460	405T	E645	405TTFS6586	√	2:1	\$14,130	E9	94.5	90.0	1280	37.12		A223
	1200	575	405T	E404	405TTFS6587	√	2:1	\$14,130	E9	94.5	71.5	1280	37.12		A223
100	3600	460	405TS	E613	405TSTFS6501	√	2:1	\$15,581	E9	95.0	108.0	1295	34.12		A226
	3600	575	405TS	E493	405TSTFS6502	√	2:1	\$15,581	E9	95.0	87.0	1295	34.12		A226
	1800	460	405T	E628	405TTFS6536	√	2:1	\$13,739	E9	95.4	113.0	1330	37.12		A223
	1800	460	405T	E628-P	405TTFS16865	√	2:1	\$16,485	E9	95.4	113.0	1330	37.12	P	A223
	1800	460	405TS	E456	405TSTFS6526	√	2:1	\$13,739	E9	95.4	113.0	1330	34.12		A226
	1800	575	405T	E681	405TTFS6538	√	2:1	\$13,739	E9	95.4	90.5	1330	37.12		A223
	1200	460	444T	E327	444TTFN16577	√	2:1	\$21,219	E9	95.0	124.0	1970	41.34		A620
	1200	460	444T	E646A	444TTFN16581	√	2:1	\$21,219	E9	95.0	124.0	1806	43.35		A620
1200	575	444T	E405A	444TTFN16582	√	2:1	\$21,219	E9	95.0	94.5	1690	41.25		A229	
125	3600	460	444TS	E614	444TSTFS6501	√	2:1	\$20,369	E9	95.4	136.0	1725	37.50		A232
	3600	575	444TS	E494	444TSTFS6505	√	2:1	\$20,369	E9	95.4	109.0	1725	37.50		A232
	1800	460	444T	E629	444TTFS6536	√	2:1	\$18,086	E9	95.4	141.0	1725	41.25		A229
	1800	460	444T	E629-P	444TTFN16574	√	2:1	\$21,832	E9	95.4	141.0	1725	41.25	P	A229
	1800	460	444TS	E457	444TSTFS6526	√	2:1	\$18,086	E9	95.4	141.0	1725	37.50		A232
	1800	575	444T	E697	444TTFS6540	√	2:1	\$18,086	E9	95.4	113.0	1725	41.25		A229
	1200	460	445T	E647	445TTFN6586	√	2:1	\$23,719	E9	95.0	155.0	2000	43.26		A620
	1200	575	445T	E406	445TTFN6590	√	2:1	\$23,719	E9	95.0	124.0	2000	43.26		A620
150	3600	460	445TS	E615	445TSTFN6501	√	2:1	\$24,468	E9	95.8	165.0	2187	39.44		A621
	3600	575	445TS	E495	445TSTFN6502	√	2:1	\$24,468	E9	95.8	132.0	2187	39.44		A621
	1800	460	445T	E630	445TTFN6536	√	2:1	\$21,028	E9	95.8	172.0	2070	43.26		A620
	1800	460	445TS	E458	445TSTFN6526	√	2:1	\$21,028	E9	95.8	172.0	2070	39.44		A621
	1800	575	445T	E682	445TTFN6537	√	2:1	\$21,028	E9	95.8	138.0	2070	43.26		A620
	1200	460	445T	E448	445TTFN6587	√	2:1	\$26,536	E9	95.8	180.0	2500	43.26	H, RB	N/A
	1200	575	445T	E407	445TTFN6591	√	2:1	\$26,536	E9	95.8	145.0	2500	43.26	RB	N/A
	200	3600	460	445TS	E449	445TSTFN6505	√	2:1	\$30,953	E9	95.8	222.0	2300	39.44	H
3600		575	445TS	E496	445TSTFN6506	√	2:1	\$30,953	E9	95.8	178.0	2300	39.44		A621
1800		460	445T	E631	445TTFN6538	√	2:1	\$25,574	E9	96.2	226.0	2437	43.26	RB	N/A
1800		460	445TS	E459	445TSTFN6528	√	2:1	\$25,574	E9	96.2	226.0	2437	39.44	H	A621
1800		460	447/9T	E770	449TTFS6530	√	2:1	\$29,410	E9	96.5	225.0	2700	51.69	H	A623
1800		460	447/9T	E854	449TTFS6540	√	2:1	\$29,410	E9	96.5	225.0	2700	51.69	d, H, RB	N/A
1800		575	447/9T	E856	449TTFS6564	√	2:1	\$29,410	E9	96.5	180.0	2700	51.69	H, RB	N/A
1200		460	447/9T	E773	449TTFS6578	√	2:1	\$32,485	E9	95.8	240.0	2927	51.69	H	A623
1200		460	447/9T	E687	449TTFS6588	√	2:1	\$32,485	E9	95.8	240.0	2927	51.69	H, RB	N/A
1200		575	447/9T	E408	449TTFS6582	√	2:1	\$32,485	E9	95.8	192.0	2927	51.69	H, RB	N/A
250	3600	460	447/9TS	E699	449TSTFS6503	√	2:1	\$39,038	E9	95.8	275.0	2700	47.88	H	A624
	1800	460	447/9T	E771	449TTFS6528	√	2:1	\$36,896	E9	96.5	285.0	2830	51.69	H	A623
	1800	460	447/9T	E690	449TTFS6538	√	2:1	\$36,896	E9	96.5	285.0	2830	51.69	H, RB	N/A
	1200	460	L447/9T	E774	449TTFS6577	√	2:1	\$37,343	E9	95.8	300.0	3415	51.69	H	A623
	1200	460	L447/9T	E688	449TTFS6587	√	2:1	\$37,343	E9	95.8	300.0	3415	51.69	H, RB	N/A
300	3600	460	447/9TS	E698	449TSTFS6502	√	2:1	\$50,599	E9	96.2	330.0	2700	47.88	H	A624
	1800	460	447/9T	E691	449TTFS6537	√	2:1	\$40,959	E9	96.5	339.0	3211	51.69	H, RB	N/A
	1800	460	447/9T	E772	449TTFS6527	√	2:1	\$40,959	E9	96.5	339.0	3211	51.69	H	A623
	1800	575	447/9T	E345	449TTFS16534	√	2:1	\$40,959	E9	96.5	271.0	3211	51.69	H, RB	N/A
350	3600	460	447/9TS	E769	449TSTFS6501	√	2:1	\$58,025	E9	95.8	380.0	3064	47.88	H	A624
	1800	460	447/9T	E692	449TTFS6536	√	2:1	\$47,843	E9	96.2	395.0	3350	51.69	H, RB	N/A
400	3600	460	5011S	E369	—	√	N/A	\$100,508	S6	95.8	432.0	5500	67.19	90	N/A
	1800	460	L447/9T	E776	449TTFS16553	√	2:1	\$49,119	E9	96.2	448.0	3800	56.71	79, H	N/A
	1200	460	5011LS	E362	—	√	N/A	\$141,125	S6	95.8	468.0	5500	67.19	77, 79, 90	N/A
450	1800	460	L447/9T	E777	—	√	N/A	\$50,369	E9	96.5	515.0	3800	56.71	79, H	N/A
	1200	460	5013LS	E363	5013LSTFS6595	√	N/A	\$146,493	S6	96.2	525.0	7200	67.19	77, 79, 90, A	N/A
500	1800	460	5011LS	E364	5011LSTFS16031	√	N/A	\$100,967	S6	96.2	555.0	5500	67.19	77, 79, 90	N/A
	1200	460	5013LS	E365	—	√	N/A	\$155,470	S6	96.2	580.0	7200	76.19	78, 79, 90	N/A
600	1800	460	5011LS	E366	5011LSTFS16033	√	N/A	\$119,632	S6	96.2	655.0	5500	67.19	77, 79, 90, A	N/A

Catalog numbers (Cat No.) highlighted in bold blue are premium efficient.

Blue shaded areas are cast iron frames.

* Requires nameplate modification.

NEMA Premium is a trademark of National Electrical Manufacturers Association. All Rights Reserved.

BLUE CHIP SERIES® SEVERE DUTY / AUTOMOTIVE DUTY MOTORS

NEMA PREMIUM® XRI® MOTORS IEEE-841
TOTALLY ENCLOSED, RIGID BASE, THREE PHASE



SEVERE DUTY

APPLICATIONS:

For extreme applications in the process industries such as chemical plants, pulp and paper mills, refineries, above-ground mines, food processing, foundries, and other severe duty environments where long life and ultra-high efficiency are required. Guaranteed efficiencies offer an eXtra return on your investment when using these premium efficiency motors on high cycle or long run time applications.

FEATURES:

- Meets or exceeds NEMA Premium® efficiencies
- NEMA Premium models are in compliance with EISA 2007
- Meets IEEE-841 standard for severe duty motor applications
- Bearing current protection (BCP), as noted
- Blue Chip Series® motor quality, 100% cast iron construction for rigidity and reduced vibration
- Inpro/Seal® VBX® bearing isolators on drive end shaft extension TENV and on both ends of TEFC
- Provisions to add stub shaft for an encoder (182T-449T, TEFC only)
- Internal and external epoxy paint
- MAX GUARD® motor Class F insulation system
- Constant torque speed range is listed in CT speed range column
- 1.15 service factor on sinewave, 1.0 service factor on IGBT power
- Bearing caps (254T and larger)
- Precision balanced to .08"/sec
- Extended grease tubes, regreasable in service
- Brass drain and breather



- Meets General Motors® GM® 7E-TA automotive duty specification
- Meets IEEE45 USCG marine duty, API RPI4F for offshore platforms, IP56
- Meets NEMA® MG1 - 1.26.6 waterproof specification
- **BCP (-P) models are not Hazardous Duty® motors certified for Division 2 locations**
- Hazardous Duty® motor division 2 CSA certification nameplate
- Division 2 / zone 2 class I (gases), groups A, B, C, D
- Meets temperature code T2B
- Actual test and vibration data supplied with each motor
- Ball bearings (except as noted)
- UL recognized (through 449T) and CSA certified and CE marked
- Five year warranty

MODELS THROUGH 40 HP ARE CAPABLE OF MODIFICATION AS FOLLOWS (CONTACT FACTORY TO CONFIRM):

- 1.25 service factor (sinewave only)
- 50Hz at same HP, 1.0 service factor (sinewave only)
- Any nameplate changes are subject to modification charges (see MOD central section)
- Contact your sales representative for optional nameplate markings on 50 HP and larger

HP	RPM	VOLTS	FRAME	CAT. NO.	MODEL NO.	STOCK	CT SPEED RANGE*	LIST PRICE	MULT. SYMB.	NOM. EFF.	F.L. AMPS	WT.	"C" DIM.	FOOT NOTES	C-FACE KITS
1	1800	460	143T	W501	143THTN9026	√	1000:1	\$826	E9	85.5	1.5	58	10.43	75, 76, N	A181
	1800	575	143T	W502	143THTN19033		1000:1	\$826	E9	85.5	1.2	58	10.43	75, 76, N	A181
	1200	460	145T	W503A	—		1000:1	\$1,040	E9	82.5	1.6	48	13.99	75, 76, N	A262
	1200	575	145T	W638A	—		1000:1	\$1,040	E9	82.5	1.4	48	13.99	75, 76, N	A262
	900	460	182T	W504	182THFS19101		20:1	\$1,826	E9	78.5	1.9	81	15.40	75	A182
1 1/2	3600	460	143T	W505	143THTN9001		1000:1	\$1,034	E9	86.5	2.0	62	10.43	75, 76, N	A181
	3600	575	143T	W506	143THTN9005		1000:1	\$1,034	E9	86.5	1.6	57	10.43	75, 76, N	A181
	1800	460	145T	W507A	145THTN19059	√	1000:1	\$895	E9	86.5	2.3	70	11.43	75, 76, N	A262
	1800	575	145T	W508A	—		1000:1	\$895	E9	86.5	1.8	70	11.43	75, 76, N	A262
	1200	460	182T	W509	182THTS9076		1000:1	\$1,331	E9	87.5	2.2	130	12.71	75, N	A182
2	3600	460	145T	W511	145THTN9001		1000:1	\$1,084	E9	85.5	2.5	67	11.43	75, 76, N	A262
	3600	575	145T	W512	145THTN19002		1000:1	\$1,084	E9	86.5	2.1	68	11.43	75, 76, N	A262
	1800	460	145T	W513A	145THTN19058	√	1000:1	\$984	E9	86.5	3.0	100	11.43	75, 76, N	A262
	1800	575	145T	W514A	—		1000:1	\$984	E9	86.5	2.4	100	11.43	75, 76, N	A262
	1200	460	184T	W515	184THTS9076		1000:1	\$1,644	E9	88.5	3.0	135	13.71	75, N	A182

Catalog numbers (Cat No.) highlighted in bold blue are premium efficient.

* Requires nameplate modification.

Continued on next page.

Blue shaded areas are cast iron frames.

Inpro/Seal and VBX are believed to be the trademarks or trade names of INPRO/SEAL LLC and are not controlled by Regal Beloit Corporation.

General Motors and GM are believed to be trademarks or trade names of General Motors LLC and are not controlled by Regal Beloit Corporation.

NEMA and NEMA Premium are trademarks of National Electrical Manufacturers Association. All Rights Reserved.

Prices and specifications are subject to change without notice.

BLUE CHIP SERIES® SEVERE DUTY / AUTOMOTIVE DUTY MOTORS

NEMA PREMIUM® XRI® MOTORS IEEE-841

TOTALLY ENCLOSED, RIGID BASE, THREE PHASE

SEVERE DUTY

HP	RPM	VOLTS	FRAME	CAT. NO.	MODEL NO.	STOCK	CT SPEED RANGE*	LIST PRICE	MULT. SYMB.	NOM. EFF.	F.L. AMPS	WT.	"C" DIM.	FOOT NOTES	C-FACE KITS	
3	3600	460	182T	W517	182THTS9001		1000:1	\$1,489	E9	89.5	3.8	103	12.71	75, N	A182	
	1800	460	182T	W519	182THTS9026	√	1000:1	\$1,335	E9	90.2	4.0	104	12.71	75, N	A182	
	1800	575	182T	W520	182THTS19033		1000:1	\$1,335	E9	90.2	3.2	110	12.71	75, N	A182	
	1200	460	213T	W521	213THFS9076	√	20:1	\$2,025	E9	89.5	4.4	181	18.22	d, 75	A183	
	1200	460	213T	W521A	213THFND9076	√	20:1	\$2,025	E9	89.5	4.4	206	19.63	75	A183A	
	900	460	215T	W522	215THFS9101		20:1	\$3,033	E9	86.5	5.0	167	19.72	75	A183	
5	3600	460	184T	W523	184THFS9001	√	2:1	\$1,654	E9	88.5	5.9	126	16.18	75	A182	
	3600	575	184T	W524	184THFS19006		2:1	\$1,654	E9	88.5	4.7	126	16.18	75	A182	
	1800	460	184T	W525	184THFS9026	√	20:1	\$1,548	E9	90.2	6.2	131	16.18	75	A182	
	1800	575	184T	W526	184THFS9030	√	20:1	\$1,548	E9	90.2	5.0	130	16.18	75	A182	
	1200	460	215T	W527	215THFS9076	√	20:1	\$2,485	E9	89.5	6.9	215	19.72	d, 75	A183	
	1200	460	215T	W527A	215THFND9076	√	20:1	\$2,485	E9	89.5	6.9	220	19.63	75	A183A	
	1200	575	215T	W528	215THFS19077		20:1	\$2,485	E9	89.5	5.5	215	19.72	75	A183	
	900	460	254T	W529	254THFNA9101		10:1	\$3,953	E9	88.5	7.5	370	23.65	75	A184	
	7 1/2	3600	460	213T	W530	213THTS9001	√	2:1	\$1,998	E9	91.7	8.9	191	17.18	75, N	A183
3600		575	213T	W531	213THTS19005		2:1	\$1,998	E9	91.7	7.1	191	17.18	75, N	A183	
1800		460	213T	W532	213THFS9026	√	20:1	\$1,896	E9	91.7	9.6	200	19.73	d, 75	A183	
1800		460	213T	W532A	213THFND9026	√	20:1	\$1,896	E9	91.7	9.6	222	19.63	75	A183A	
1800		575	213T	W533	213THFS9030	√	20:1	\$1,896	E9	91.7	7.7	204	19.72	75	A183	
1200		460	254T	W534	254THFNA9076	√	20:1	\$2,984	E9	91.0	9.9	260	23.65	75	A184	
900		460	256T	W536	256THFNA9101		20:1	\$4,901	E9	88.5	11.0	340	25.40	75	A184	
10		3600	460	215T	W537	215THFS9001	√	2:1	\$2,333	E9	91.7	11.8	234	19.72	d, 75	A183
		3600	460	215T	W537A	215THFND9001	√	2:1	\$2,333	E9	90.2	11.9	258	19.63	75	A183A
	3600	575	215T	W538	215THFS19006		2:1	\$2,333	E9	91.7	9.5	225	19.72	75	A183	
	1800	460	215T	W539	215THFS9026	√	20:1	\$2,284	E9	91.7	12.5	243	19.73	d, 75	A183	
	1800	460	215T	W539A	215THFND9026	√	20:1	\$2,284	E9	91.7	13.3	250	22.63	75	A183A	
	1800	575	215T	W540	215THFS19033	√	20:1	\$2,284	E9	91.7	10.0	257	19.73	75	A183	
	1200	460	256T	W541	256THFNA9076	√	20:1	\$3,644	E9	91.0	13.1	383	25.40	75	A184	
	1200	575	256T	W542	256THFNA19081	√	20:1	\$3,644	E9	91.0	10.5	265	25.40	75	A184	
	900	460	284T	W543	284THFNA19102		20:1	\$5,959	E9	90.2	15.5	524	26.21		A186	
	15	3600	460	254T	W544	254THFNA9001	√	20:1	\$2,893	E9	91.7	17.5	349	23.65	75	A184
1800		460	254T	W546	254THFNA9026	√	20:1	\$2,716	E9	92.4	18.8	319	23.65	75	A184	
1800		460	254T	W546-P	254THFNA19065	√	20:1	\$3,124	E9	92.4	18.8	410	25.40	P, 75	A184	
1800		575	254T	W547	254THFNA9030	√	20:1	\$2,716	E9	92.4	15.0	362	23.65	75	A184	
1200		460	284T	W548	284THFNA9076	√	20:1	\$4,838	E9	91.7	20.4	489	26.21		A186	
1200		575	284T	W549	284THFNA19084	√	20:1	\$4,838	E9	91.7	16.3	460	26.34		A186	
900		460	286T	W550	286THFNA19101	√	20:1	\$7,475	E9	90.2	22.0	326	27.71		A186	
20		3600	460	256T	W551	256THFNA9001	√	2:1	\$3,585	E9	92.4	23.4	366	25.40	75	A184
	1800	460	256T	W553	256THFNA9026	√	20:1	\$3,385	E9	93.0	24.1	406	25.40	75	A184	
	1800	460	256T	W553-P	256THFNA19056	√	20:1	\$3,893	E9	93.0	24.1	392	25.40	75, P	A184	
	1800	575	256T	W554	256THFNA19033	√	20:1	\$3,385	E9	93.0	19.5	355	25.40	75	A184	
	1200	460	286T	W555	286THFNA9076	√	20:1	\$5,893	E9	91.7	26.8	550	27.71		A186	
	1200	575	286T	W556	286THFNA19077	√	20:1	\$5,893	E9	91.7	21.5	468	27.71		A186	
	25	3600	460	284TS	W558	284TSHFNA9001	√	2:1	\$4,416	E9	93.0	28.8	472	25.06		A186
3600		575	284TS	W559	284TSHFNA9005		2:1	\$4,416	E9	93.0	23.1	461	25.06		A186	
1800		460	284T	W560	284THFNA9026	√	20:1	\$4,029	E9	93.6	31.0	489	26.21		A186	
1800		460	284T	W560-P	284THFNA19048	√	20:1	\$4,633	E9	93.6	31.0	458	26.21	P	A186	
1800		575	284T	W561	284THFNA19033	√	20:1	\$4,029	E9	93.6	24.8	635	26.21		A186	
1200		460	324T	W562	324THFS9076	√	20:1	\$7,144	E9	93.0	32.5	671	28.87		A187	
1200		575	324T	W563	324THFS9080		20:1	\$7,144	E9	93.0	26.0	715	28.87		A187	
30		3600	460	286TS	W565	286TSHFNA9001	√	2:1	\$5,158	E9	93.6	34.0	368	26.56		A186
	1800	460	286T	W567	286THFNA9026	√	20:1	\$4,686	E9	94.1	36.5	528	27.71		A186	
	1800	460	286T	W567-P	286THFNA19066	√	20:1	\$5,389	E9	94.1	36.5	490	27.71	P	A186	
	1800	575	286T	W568	286THFNA19033		20:1	\$4,686	E9	94.1	29.2	650	27.71		A186	
	1200	460	326T	W569	326THFS9076	√	2:1	\$8,228	E9	93.0	38.5	700	30.37		A187	
	1200	575	326T	W643	326THFS19078	√	2:1	\$8,228	E9	93.0	31.0	752	30.37		A187	

Catalog numbers (Cat No.) highlighted in bold blue are premium efficient.

* Requires nameplate modification.

Continued on next page.

Blue shaded areas are cast iron frames.

BLUE CHIP SERIES® SEVERE DUTY / AUTOMOTIVE DUTY MOTORS

NEMA PREMIUM® XRI® MOTORS IEEE-841

TOTALLY ENCLOSED, RIGID BASE, THREE PHASE

SEVERE DUTY

HP	RPM	VOLTS	FRAME	CAT. NO.	MODEL NO.	STOCK	CT SPEED RANGE*	LIST PRICE	MULT. SYMB.	NOM. EFF.	FL. AMPS	WT.	"C" DIM.	FOOT NOTES	C-FACE KITS	
40	3600	460	324TS	W571	324TSHFS9001	√	2:1	\$6,801	E9	93.6	470	656	27.37		A187	
	1800	460	324T	W573	324THFS9026	√	2:1	\$6,223	E9	94.1	475	700	28.87		A187	
	1800	460	324T	W573-P	324THFS19058	√	2:1	\$7,156	E9	94.1	475	700	28.87	P	A187	
	1800	575	324T	W574	324THFS19033		2:1	\$6,223	E9	94.1	38.0	700	30.37		A187	
	1200	460	364T	W575A	364THFS19087	√	2:1	\$10,259	E9	94.1	50.0	950	31.50		A188	
	1200	575	364T	W639	364THFS19077		2:1	\$10,259	E9	94.1	40.0	950	31.50		A188	
	900	460	365T	W576	365THFS19101		2:1	\$14,626	E9	91.7	53.0	975	32.50		A188	
50	3600	460	326TS	W577	326TSHFS9001	√	2:1	\$8,798	E9	93.6	58.0	725	28.87		A187	
	3600	575	326TS	W578	326TSHFS9005		2:1	\$8,798	E9	93.6	46.5	725	28.87		A187	
	1800	460	326T	W580	326THFS9026	√	2:1	\$7,644	E9	94.5	60.0	775	30.37		A187	
	1800	460	326T	W580-P	326THFS19071	√	2:1	\$8,790	E9	94.5	60.0	775	30.37	P	A187	
	1800	460	326TS	W579	326TSHFS9036		2:1	\$7,644	E9	94.5	60.0	775	28.87		A187	
	1800	575	326T	W581	326THFS19033		2:1	\$7,644	E9	94.5	48.0	775	30.37		A187	
	1200	460	365T	W582A	365THFS19086	√	2:1	\$12,583	E9	94.1	61.5	975	32.50		A188	
	1200	575	365T	W640	365THFS19077		2:1	\$12,583	E9	94.1	49.0	975	32.50	NP	A188	
	900	460	404T	W583	404THFS9101		2:1	\$16,458	E9	93.6	66.0	1264	35.62		A190	
60	3600	460	364TS	W584	364TSHFS9001	√	2:1	\$10,649	E9	94.5	67.0	925	29.38		A189	
	1800	460	364T	W587	364THFS9036	√	2:1	\$10,088	E9	95.0	69.0	1000	31.50		A188	
	1800	460	364T	W587-P	364THFS19061	√	2:1	\$10,895	E9	95.0	69.0	1000	31.50	P	A188	
	1800	460	364TS	W286	364TSHFS9026		2:1	\$10,088	E9	95.0	69.0	1000	29.38		A189	
	1800	575	364T	W588	364THFS19033		2:1	\$10,088	E9	95.0	55.0	1000	31.50		A188	
	1200	460	404T	W589	404THFS9086		2:1	\$13,804	E9	94.5	72.0	1156	35.62		A190	
	900	460	405T	W590	405THFS19101		2:1	\$18,466	E9	93.6	80.0	1350	37.12		A190	
	75	3600	460	365TS	W591	365TSHFS9001	√	2:1	\$13,371	E9	94.5	84.0	1002	30.38		A189
		3600	575	365TS	W592	365TSHFS19002		2:1	\$13,371	E9	94.5	67.0	1002	30.38		A189
1800		460	365T	W594	365THFS9036	√	2:1	\$12,789	E9	95.4	86.0	1100	32.50		A188	
1800		460	365T	W594-P	365THFS19065	√	2:1	\$13,934	E9	95.4	86.0	1100	32.50	P	A188	
1800		460	365TS	W593A	365TSHFS19034		2:1	\$12,789	E9	95.4	86.0	1100	30.38		A189	
1800		575	365T	W595	365THFS9044		2:1	\$12,789	E9	95.4	69.0	1100	32.50		A188	
1200		460	405T	W596	405THFS9086		2:1	\$16,248	E9	95.0	90.0	1280	37.12		A190	
900		460	444T	W597	444THFS9101		2:1	\$24,544	E9	93.6	100.0	1734	41.25		A192	
100		3600	460	405TS	W598	405TSHFS9001	√	2:1	\$17,918	E9	95.0	108.0	1295	34.12		A191
	1800	460	405T	W600	405THFS9036	√	2:1	\$15,800	E9	95.4	113.0	1330	37.12		A190	
	1800	460	405T	W600-P	405THFS19327	√	2:1	\$17,064	E9	95.4	113.0	1330	37.12	P	A190	
	1800	460	405TS	W599	405TSHFS9026		2:1	\$15,800	E9	95.4	113.0	1330	34.12		A191	
	1800	575	405T	W601	405THFS9040	√	2:1	\$15,800	E9	95.4	90.0	1330	37.12	d	A190	
	1200	460	444T	W636	444THFN19081		2:1	\$23,960	E9	95.0	124.0	2100	41.25		A194	
	900	460	445T	W603	445THFN9106		2:1	\$30,090	E9	94.1	142.0	2350	43.19		A194	
	125	3600	460	444TS	W604	444TSHFS9001		2:1	\$23,425	E9	95.4	136.0	1725	37.50		A193
3600		460	444TS	W604A	444TSHFN19002		2:1	\$23,425	E9	95.0	142.0	1725	39.60		A195	
1800		460	444T	W606	444THFS9036	√	2:1	\$20,800	E9	95.4	141.0	1725	41.25		A192	
1800		460	444T	W606-P	444THFN19044	√	2:1	\$22,464	E9	95.4	141.0	1725	41.25	P	A194	
1800		575	444T	W607	444THFS9040		2:1	\$20,800	E9	95.4	113.0	1725	41.25		A192	
1200		460	445T	W608	445THFN9086		2:1	\$27,275	E9	95.0	155.0	2000	43.19		A194	
900		460	445T	W609	445THFN9102		2:1	\$30,905	E9	94.5	172.0	2515	43.19		A194	
150		3600	460	445TS	W610	445TSHFN9001		2:1	\$28,139	E9	95.8	165.0	2187	39.37		A195
	1800	575	445TS	W611	445TSHFN9026		2:1	\$24,181	E9	95.8	172.0	2070	39.37		A195	
	1800	460	445T	W612	445THFN9036	√	2:1	\$24,181	E9	95.8	172.0	2070	43.19		A194	
	1800	460	445T	W612-P	445THFN19071	√	2:1	\$26,115	E9	95.8	172.0	2070	43.19	P	A194	
	1800	575	445T	W641	445THFN19033		2:1	\$24,181	E9	95.8	138.0	2070	43.19	RB	A194	
	1800	575	445T	W613	445THFN9037		2:1	\$24,181	E9	95.8	138.0	2070	43.19		A194	
	1200	460	445T	W614	445THFN9087		2:1	\$30,519	E9	95.8	181.0	2500	43.19	H, RB	A194	
	900	460	L447/9T	W615	449THFS9101		2:1	\$39,306	E9	95.4	205.0	3150	51.88		N/A	

Catalog numbers (Cat No.) highlighted in bold blue are premium efficient.

* Requires nameplate modification.

Continued on next page.

Blue shaded areas are cast iron frames.

BLUE CHIP SERIES® SEVERE DUTY / AUTOMOTIVE DUTY MOTORS

NEMA PREMIUM® XRI® MOTORS IEEE-841

TOTALLY ENCLOSED, RIGID BASE, THREE PHASE

HP	RPM	VOLTS	FRAME	CAT. NO.	MODEL NO.	STOCK	CT SPEED RANGE*	LIST PRICE	MULT. SYMB.	NOM. EFF.	FL. AMPS	WT.	"C" DIM.	FOOT NOTES	C-FACE KITS
200	3600	460	445TS	W616	445TSHFN9005		2:1	\$35,596	E9	95.4	224	2276	39.60	H, SL	A195
	1800	460	445T	W618	445THFN9038		2:1	\$29,410	E9	96.2	226	2355	43.35	RB	A194
	1800	460	445T	W618-P	445THFN19070	√	2:1	\$31,763	E9	96.2	226	2202	43.35	P, RB	A194
	1800	460	445TS	W617	445TSHFN9028		2:1	\$29,410	E9	96.2	226	2200	39.60		A195
	1800	460	447/449T	W619	449THFS9030		2:1	\$33,820	E9	96.5	225	2538	51.84		N/A
	1800	575	445T	W642	445THFN19034	√	2:1	\$33,820	E9	96.2	181	2376	43.19		A194
	1200	460	447/449T	W621	449THFS19092		2:1	\$37,358	E9	95.8	240	2950	51.84		N/A
	1200	460	447/449T	W622	449THFS9088		2:1	\$37,358	E9	95.8	240	2930	51.84	RB	N/A
	1200	575	447/449T	W630	449THFS19079		2:1	\$37,358	E9	95.8	192	2882	51.69	RB	N/A
	250	3600	460	447/449TS	W624	449TSHFS9003		2:1	\$44,893	E9	96.2	270	2635	47.88	
1800		460	447/449T	W626	449THFS9028		2:1	\$42,433	E9	96.5	285	2834	51.84		N/A
1800		460	447/449T	W626-P	449THFS19342	√	2:1	\$45,828	E9	96.5	285	2736	51.84	P	N/A
300	1800	460	447/449T	W632	449THFS9027		2:1	\$43,281	E9	96.5	339	3039	51.84		N/A
350	3600	460	447/449TS	W634	449TSHFS9001		2:1	\$66,730	E9	95.8	380	2888	47.94	SL	N/A
	1800	460	447/449T	W635	449THFS9036		2:1	\$55,019	E9	96.2	395	3082	51.84	RB, SL	N/A

Catalog numbers (Cat No.) highlighted in bold blue are premium efficient.

Blue shaded areas are cast iron frames.

* Requires nameplate modification.

HAZARDOUS DUTY® DIVISION 1 EXPLOSION PROOF MOTORS

CLASS I AND II, GROUPS D, F & G

BLUE CHIP SERIES® SEVERE DUTY, NEMA® PREMIUM EFFICIENCY, THREE PHASE MOTORS

FEATURES:

- 10:1 variable torque, constant torque, as noted
- CR²⁰⁰ corona resistant, 200°C rated magnet wire
- 1.15 service factor
- Normally closed thermostats (must be connected to control circuit)
- Meets temperature code T3B
- All cast iron construction (except as noted)
- External surface treated with epoxy paint
- Nameplated 60/50 hertz, 190/380 volts, at next lower horsepower, as noted
- UL listed file no. E12044
- CSA certified file no. LR47504
- Three year warranty



IP54

C-FACE FOOTED (RIGID BASE)

HP	RPM	VOLTS	FRAME	CAT. NO.	MODEL NO.	STOCK	CT SPEED RANGE	LIST PRICE	MULT. SYMB.	NOM. EFF.	F.L. AMPS	WT.	"C" DIM.	FOOT NOTES
1	1800	208-230/460	143TC	C361A	143TTGN6551	√	10:1	\$1,108	E7	85.5	3.0-3.0/1.5	72	15.23	68, 80
1 1/2	1800	230/460	145TC	C362A	145TTGN6536	√	10:1	\$1,173	E7	86.5	4.6/2.3	88	15.23	68, 80
2	1800	230/460	145TC	C363A	145TTGN6549	√	10:1	\$1,233	E7	86.5	6.0/3.0	90	15.23	68, 80
3	1800	230/460	182TC	C364A	182TTGN6569	√	10:1	\$1,433	E7	90.2	8.0/4.0	154	16.62	68
	1800	575	182TC	C368A	182TTGN6536	√	10:1	\$1,433	E7	90.2	3.2	119	16.62	
5	1800	230/460	184TC	C365A	184TTGN6575	√	10:1	\$1,561	E7	90.2	12.4/6.2	168	18.62	68
	1800	575	184TC	C369A	184TTGN6537	√	10:1	\$1,561	E7	90.2	5.0	167	18.62	
7 1/2	1800	230/460	213TC	C366A	213TTGN6528	√	10:1	\$2,123	E7	91.7	20.0/10.0	236	20.45	d, 68
	1800	230/460	213TC	C366B	213TTGND6528	√	10:1	\$2,123	E7	91.7	19.2/9.6	256	20.45	68
	1800	575	213TC	C370A	213TTGN6536	√	10:1	\$2,123	E7	91.7	8.0	260	20.45	d
	1800	575	213TC	C370B	213TTGND6536	√	10:1	\$2,123	E7	91.7	7.7	250	20.45	
10	1800	230/460	215TC	C367A	215TTGN6528	√	2:1	\$2,441	E7	91.7	25.0/12.5	274	23.45	d, 68, CD
	1800	230/460	215TC	C367B	215TTGND6528	√	2:1	\$2,441	E7	91.7	26.6/13.3	268	23.45	68, CD
	1800	575	215TC	C371A	215TTGN16534	√	2:1	\$2,441	E7	91.7	10.0	280	23.45	

Catalog numbers (Cat No.) highlighted in bold blue are premium efficient.
Blue shaded areas are cast iron frames.

EXPLOSION PROOF

HAZARDOUS DUTY® DIVISION 1 EXPLOSION PROOF MOTORS

CLASS I AND II, GROUPS C, D, E (AS NOTED), F & G

STEEL FRAME, STANDARD AND NEMA® PREMIUM EFFICIENCIES, THREE PHASE MOTORS

FEATURES:

- 1.0 service factor (except as noted)
- Meets temperature code T3B
- Explosion proof conduit box included, shipped loose
- UL listed file no. E12044
- CSA certified file no. LR47504
- K717 is rated for Class I Group D, Class II Groups F & G only
- Automatic overload (except as noted)



RIGID BASE

HP	RPM	VOLTS	FRAME	GROUP E	CAT. NO.	MODEL NO.	STOCK	LIST PRICE	MULT. SYMB.	NOM. EFF.	FL. AMPS	APPX. WT.	"C" DIM.	FOOT NOTES
1/4	1800	230/460	48	N	K717	5K32GNB249	✓	\$921	F1	62.5	1.2/0.6	19	9.68	
	1800	208-230/460	56	N	G646	056T17E5308	✓	\$869	F1	71.0	1.1-1.1/.55	25	11.97	N
	1800	575	56	N	G664	056T17E5314	✓	\$869	F1	71.0	0.43	25	11.97	N
1/3	1800	208-230/460	56	N	G647	056T17E5309	✓	\$924	F1	74.0	1.3-1.2/.60	25	11.97	N
	1800	575	56	N	G665	056T17E5315		\$924	F1	74.0	0.5	25	11.97	N
	1200	230/460	56	N	K2101	5K49FN6381	✓	\$1,248	F1	62.0	2.2/1.1	29	13.44	
1/2	3600	208-230/460	56	N	G648	056T34G5303		\$849	F1	66.5	2.1-2.4/1.2	30	13.44	
	1800	208-230/460	56	N	G649	056T17G5312	✓	\$977	F1	68.0	2.3-2.4/1.2	28	13.94	
	1800	200	56	N	K2102	5K49JN4582		\$1,117	F1	68.0	2.75	29	13.94	
	1800	575	56	N	G666	056T17G5321	✓	\$977	F1	68.0	1.0	28	13.94	
	1200	230/460	56	N	K2104	5K49HN6385	✓	\$1,315	F1	68.0	2.7/1.35	34	13.44	
3/4	3600	208-230/460	56	N	G660	056T34G5304		\$932	F1	74.0	3.0-3.2/1.6	30	13.44	
	1800	208-230/460	56	N	G661	143TTGR16026	✓	\$1,031	F1	75.5	2.9-3.0/1.5	30	13.94	
	1800	200	56	N	K2105	5K49JN4574		\$1,191	F1	75.5	3.45	31	13.94	18
	1800	575	56	N	G667	056T17G5322	✓	\$1,031	F1	75.5	1.2	29	13.94	
	1200	208-230/460	143T	N	K2107	5K49MN8349	✓	\$1,407	F1	74.0	3.2-3.2/1.6	42	14.00	
	1200	208-230/460	56	N	K2116	5K49MN6382	✓	\$1,399	F1	74.0	3.2-3.2/1.6	42	13.94	
1	3600	230/460	56	N	G662A	056T34G15577	✓	\$1,069	F1	80.0	3.0/1.5	33	13.94	
	1800	230/460	56	N	G663A	056T17G15600	✓	\$1,124	F1	85.5	3.2/1.6	67	15.58	A
	1800	230/460	143T	Y	I502	143TTGR16026	✓	\$1,270	E7	85.5	3.3/1.65	49	16.00	TS
	1800	575	56	N	G668A	056T17G15598	✓	\$1,124	F1	85.5	1.3	75	15.58	A
	1800	575	143T	Y	I503	143TTGR16030		\$1,270	E7	85.5	1.3	48	16.00	A, TS
	1200	230/460	56H	N	K2110	5K49TN6383	✓	\$1,468	F1	80.0	3.4/1.7	43	15.50	d
	1200	230/460	56H	N	K2110A	056T11G15528	✓	\$1,584	F1	82.5	3.8/1.9	50	16.08	
	1200	230/460	145T	Y	I504	145TTGR16076	✓	\$1,538	E7	82.5	3.8/1.9	53	16.50	TS
	1200	575	145T	Y	I505	145TTGR16080		\$1,538	E7	82.5	1.5	58	16.50	TS
1 1/2	3600	230/460	143T	Y	I506	143TTGR16001	✓	\$1,176	E7	84.0	4.0/2.0	44	14.50	TS
	3600	575	143T	Y	I507	143TTGR16005	✓	\$1,176	E7	84.0	1.6	44	14.50	TS
	1800	230/460	56H	N	K2111A	056T17G15602	✓	\$1,415	F1	86.5	4.6/2.3	50	15.58	18
	1800	230/460	145T	Y	I508	145TTGR16038	✓	\$1,204	E7	86.5	4.6/2.3	51	16.00	18, TS
	1800	575	145T	Y	I509	145TTGR16030	✓	\$1,204	E7	86.5	1.85	42	16.00	TS
2	3600	230/460	145T	Y	I512	145TTGR16002	✓	\$1,764	E7	85.5	5.0/2.5	55	16.50	18, TS
	3600	575	145T	Y	I513	145TTGR16004	✓	\$1,764	E7	85.5	2.0	47	16.50	TS
	1800	230/460	145T	Y	I514	145TTGR16040	✓	\$1,470	E7	86.5	5.6/2.8	55	16.50	18, TS
	1800	575	145T	Y	I515	145TTGR16039	✓	\$1,470	E7	86.5	2.4	55	16.50	A, TS

Catalog numbers (Cat No.) highlighted in bold blue are premium efficient.

HAZARDOUS DUTY® DIVISION I EXPLOSION PROOF MOTORS

CLASS I AND II, GROUPS C, D, F & G
SEVERE DUTY, THREE PHASE MOTORS

FEATURES:

- 56 frame rolled steel, 143-256TC cast iron “Blue Chip®” thermal protection
- Thermal protection, 56 frame auto overload, 143-256TC T-stats
- Conduit box shipped loose on 56 frame, installed on 143-256TC
- Service factor 1.0 unless otherwise noted
- 56 frame class I, groups C & D, class II, groups F & G
- 143-256TC class I, group D, group C as noted, class II, groups F & G
- T3B temperature code
- UL file # E12044
- CSA file #LR47504



C-FACE FOOTLESS

HP	RPM	VOLTS	FRAME	CAT. NO.	MODEL NO.	STOCK	CT SPEED RANGE	LIST PRICE	MULT. SYMB.	NOM. EFF.	FL. AMPS	WT.	“C” DIM.	FOOT NOTES
1/4	1800	208-230/460	56C	G827	056T17E5310	√	—	\$816	F1	71.0	1.1-1.1/0.55	25	11.97	CD, N
	1800	575	56C	G842	056T17E5312		—	\$816	F1	71.0	0.43	25	11.97	CD, N
1/3	1800	208-230/460	56C	G828	056T17E5311	√	—	\$862	F1	74.5	1.3-1.2/0.6	25	11.97	CD, N
	1800	575	56C	G843	056T17E5313	√	—	\$862	F1	74.5	0.50	25	11.97	CD, N
1/2	1800	208-230/460	56C	G829	056T17G5315	√	—	\$908	F1	68.0	2.3-2.4/1.2	28	13.94	CD
	1800	575	56C	G844	056T17G5318		—	\$908	F1	68.0	1.0	32	13.94	CD
3/4	1800	208-230/460	56C	G840	056T17G5316	√	—	\$958	F1	75.5	2.9-3.0/1.5	29	13.94	CD
	1800	575	56C	G845	056T17G5319	√	—	\$958	F1	75.5	1.2	29	13.94	CD
1	1800	230/460	56C	G841A	056T17G15599	√	—	\$1,068	F1	85.5	3.3/1.65	44	15.94	CD
	1800	575	56C	G846A	056T17G15615		—	\$1,068	F1	85.5	1.3	47	15.94	CD
	1800	230/460	143TC	C320B	143TTGN16539	√	10:1	\$1,025	E7	85.5	3.3/1.65	83	15.18	18, 68
1 1/2	3600	230/460	143TC	C301B	143TTGN14011		10:1	\$1,058	E7	85.5	4.0/2.0	70	13.98	18, 68
	1800	230/460	56C	K2115A	056T17G15601		—	\$1,493	F1	86.5	4.6/2.3	57	15.94	18, CD
	1800	230/460	145TC	C321B	145TTGN16036	√	—	\$1,086	E7	86.5	4.6/2.3	87	15.18	18, 68
2	3600	230/460	145TC	C302B	145TTGN16504	√	—	\$1,199	E7	86.5	230/460	72	15.18	18, 68
	1800	230/460	145TC	C322B	145TTGN16034	√	—	\$1,138	E7	86.5	6.0/3.0	85	15.18	18, 68
3	3600	230/460	182TC	C303B	182TTGN16003	√	—	\$1,569	E7	87.5	7.6/3.8	165	18.62	68
	1800	230/460	182TC	C323A	182TTGN4068	√	—	\$1,240	E7	90.2	8.8-8.0/4.0	164	18.62	68
5	1800	230/460	184TC	C304B	184TTGN16004	√	—	\$1,874	E7	88.5	12.4/6.2	175	18.62	68
	1800	230/460	184TC	C324B	184TTGN16027	√	—	\$1,484	E7	90.2	12.4/6.2	220	18.62	68
7 1/2	3600	230/460	213TC	C305	213TTGS14015	√	10:1	\$1,929	E7	88.5	19.0/9.5	241	22.25	d, 68
	3600	230/460	213TC	C305B	213TTGND16001	√	10:1	\$2,086	E7	89.5	18.2/9.1	245	23.45	68
	1800	230/460	213TC	C325B	213TTGN16027	√	—	\$2,039	E7	91.7	19.2/9.6	272	23.45	d, 68
	1800	230/460	213TC	C325C	213TTGND16027	√	—	\$2,039	E7	91.7	19.2/9.6	261	23.45	68
10	1800	230/460	215TC	C306B	215TTGND16006	√	10:1	\$2,373	E7	90.2	23.8/11.9	260	23.45	68
	1800	230/460	215TC	C326B	215TTGND16029	√	—	\$2,386	E7	91.7	26.6/13.3	266	23.45	68, CD
15	3600	230/460	254TC	C307B	254TTGN16524		2:1	\$3,323	E7	91.0	36.0/18.0	376	25.77	68, CD
	1800	230/460	254TC	C327A	254TTGN14042	√	—	\$2,720	E7	91.0	39/19.5	411	25.77	d, 68, CD
	1800	230/460	254TC	C327B	254TTGN16034	√	10:1	\$3,164	E7	92.4	37.5/18.8	399	25.77	68, CD
20	3600	230/460	256TC	C308B	256TTGN16004		10:1	\$3,680	E7	92.4	47.0/23.4	436	25.77	68, CD
	1800	230/460	256TC	C328B	256TTGN16034		2:1	\$3,876	E7	93.0	48.0/24.1	441	25.77	68, CD

Catalog numbers (Cat No.) highlighted in bold blue are premium efficient. Blue shaded areas are cast iron frames.

EXPLOSION PROOF

HAZARDOUS DUTY® DIVISION 1 EXPLOSION PROOF MOTORS

NEMA® PREMIUM XRI® MOTOR, CLASS I AND II, GROUPS C, D, F & G
BLUE CHIP SERIES® SEVERE DUTY, THREE PHASE MOTORS

FEATURES:

☛ Meets NEMA Premium efficiencies

- Bearing Current Protection (BCP), as noted
- 10:1 variable torque, see Inverter Duty column for constant torque
- MAX GUARD® Class F insulation
- Blue Chip Series® motor quality, 100% cast iron construction for rigidity and reduced vibration
- Internal and external surfaces treated with epoxy paint
- 1.15 service factor on sinewave or 1.0 service factor on IGBT power
- Precision balanced to .08"/sec.
- Extended grease tubes
- Normally closed thermostats (must be connected to control circuit)
- Meets temperature code T3B
- Shaft slinger
- Nameplated 60/50 Hz, 190/380 volts, at next lower HP, as noted

SEE MOD CENTRAL FOR:

C-Face kit modifications
F2 mounting

- Ball bearings (except as noted)
- UL listed file no. E12044
- CSA certified file no. LR47504
- Three year warranty



RIGID BASE

HP	RPM	VOLTS	FRAME	GROUP C	CAT. NO.	MODEL NO.	STOCK	CT SPEED RANGE	LIST PRICE	MULT. SYMB.	NOM. EFF.	FL. AMPS	APP WT.	"C" DIM.	FOOT NOTES	
3/4	1200	230/460	143T	N	H350	143TTGN7076	√	10:1	\$901	E7	74.0	3.2/1.6	55	12.48	25, 68, 80, 91	
	1	1800	230/460	143T	N	U001A	143TTGN6526	√	10:1	\$1,005	E7	85.5	3.0/1.5	68	13.48	25, 68, 80, 91
		1800	230/460	143T	Y	U986A	143TTGN6532		10:1	\$1,211	E7	85.5	3.0/1.5	68	13.48	25, 80, 91
		1800	575	143T	N	U020A	143TTGN6530	√	10:1	\$1,005	E7	85.5	1.3	68	14.73	25, 80
1 1/2	1200	230/460	145T	N	U039A	145TTGN6576	√	10:1	\$1,211	E7	82.5	3.6/1.8	76	14.73	25, 68, 80, 91	
	3600	230/460	143T	N	U058A	143TTGN6501	√	10:1	\$1,076	E7	84.0	4.0/2.0	70	13.48	25, 68, 80, 91	
	1800	230/460	145T	N	U002A	145TTGN6526	√	10:1	\$1,073	E7	86.5	4.6/2.3	83	14.73	25, 68, 80, 91	
	1800	230/460	145T	Y	U987A	145TTGN16532		10:1	\$1,289	E7	86.5	4.6/2.3	81	14.73	25, 68, 80, 91	
	1800	575	145T	N	U021A	145TTGN6537	√	10:1	\$1,073	E7	86.5	1.8	85	14.73	25, 80	
	1200	230/460	182T	N	U040A	182TTGN6576	√	10:1	\$1,263	E7	87.5	4.4/2.2	147	15.87	25, 68, 80, 91	
2	3600	230/460	145T	N	U059A	145TTGN6501	√	10:1	\$1,263	E7	85.5	5.2/2.6	70	13.48	25, 68, 80, 91	
	1800	230/460	145T	N	U003A	145TTGN6527	√	10:1	\$1,135	E7	86.5	6.0/3.0	86	14.73	25, 68, 80, 91	
	1800	575	145T	N	U022A	145TTGN6540	√	10:1	\$1,135	E7	86.5	2.4	86	14.73	25, 80	
	1800	230/460	145T	Y	U988A	145TTGN6550		10:1	\$1,366	E7	86.5	6.0/3.0	83	14.73	25, 80, 91	
	1200	230/460	184T	Y	U041A	184TTGN6576	√	10:1	\$1,429	E7	88.5	6.0/3.0	154	17.87	25, 68, 91	
3	3600	230/460	182T	Y	U060A	182TTGN6501	√	10:1	\$1,306	E7	87.5	7.6/3.8	141	15.87	25, 68, 91	
	1800	230/460	182T	Y	U004A	182TTGN6526	√	10:1	\$1,294	E7	89.5	8.0/4.0	143	15.87	25, 68, 91	
	1800	230/460	182T	Y	U989-P	182TTGN6541	√	10:1	\$1,743	E7	89.5	8.0/4.0	161	15.87	25, 68, 91, P	
	1800	575	182T	N	U023A	182TTGN6530	√	10:1	\$1,294	E7	89.5	3.2	141	15.87	25	
	1200	230/460	213T	N	U042A	213TTGN6576	√	10:1	\$1,830	E7	89.5	8.8/4.4	244	22.63	25, 68	
5	3600	230/460	184T	N	U061A	184TTGN6501	√	10:1	\$1,588	E7	88.5	12.0/6.0	161	17.87	25, 68, 91	
	1800	230/460	184T	Y	U005A	184TTGN6526	√	10:1	\$1,419	E7	89.5	12.4/6.2	155	17.87	25, 68, 91	
	1800	230/460	184T	Y	U990-P	184TTGN6544	√	10:1	\$1,913	E7	89.5	12.4/6.2	150	17.87	25, 68, 91, P	
	1800	575	184T	Y	U024A	184TTGN6530	√	10:1	\$1,419	E7	89.5	5.0	156	17.87	25	
	1200	230/460	215T	N	U043A	215TTGN6576	√	10:1	\$2,345	E7	89.5	13.8/6.9	206	22.63	d, 25, 68	
1200	230/460	215T	N	U043B	215TTGND6576	√	10:1	\$2,345	E7	89.5	13.8/6.9	206	22.63	25, 68		

Catalog numbers (Cat No.) highlighted in bold blue are premium efficient.
Blue shaded areas are cast iron frames.

Continued on next page.

HAZARDOUS DUTY® DIVISION 1 EXPLOSION PROOF MOTORS

NEMA® PREMIUM XRI® MOTOR, CLASS I AND II, GROUPS C, D, F & G

BLUE CHIP SERIES® SEVERE DUTY, THREE PHASE MOTORS

RIGID BASE

HP	RPM	VOLTS	FRAME	GROUP C	CAT. NO.	MODEL NO.	STOCK	CT SPEED RANGE	LIST PRICE	MULT. SYMB.	NOM. EFF.	FL. AMPS	WT.	"C" DIM.	FOOT NOTES
7 1/2	3600	230/460	213T	N	U062A	213TTGN6501	✓	10:1	\$2,024	E7	89.5	19.0/9.5	256	22.63	d, 25, 68, 91
	3600	230/460	213T	N	U062B	213TTGND6501	✓	10:1	\$2,024	E7	89.5	18.2/9.1	220	19.63	25, 68, 91
	1800	230/460	213T	Y	U006A	213TTGN6526	✓	10:1	\$1,920	E7	91.7	19.2/9.6	248	22.63	d, 25, 68, 91
	1800	230/460	213T	Y	U006B	213TTGND6526	✓	10:1	\$1,920	E7	91.7	19.2/9.6	240	19.63	25, 68, 91
	1800	230/460	213T	Y	U991A	213TTGN6540	✓	10:1	\$2,311	E7	91.7	19.2/9.6	251	22.63	d, 25, 68, 91
	1800	230/460	213T	Y	U991B	213TTGND6540	✓	10:1	\$2,311	E7	91.7	19.2/9.6	250	19.63	25, 68, 91
	1800	230/460	213T	Y	U991A-P	213TTGN16548	✓	10:1	\$2,589	E7	91.7	19.2/9.6	251	22.63	d, 25, 68, 91, P
	1800	230/460	213T	Y	U991B-P	213TTGND16548	✓	10:1	\$2,589	E7	91.7	19.2/9.6	250	19.63	25, 68, 91, P
	1800	575	213T	N	U025A	213TTGN16537	✓	10:1	\$1,920	E7	91.7	7.7	243	22.63	d, 25
	1800	575	213T	N	U025B	213TTGND16537	✓	10:1	\$1,920	E7	91.7	7.7	234	19.63	25
	1200	230/460	254T	Y	E500	254TTGN6576	✓	10:1	\$2,808	E7	91.0	19.8/9.9	345	23.52	68
	10	3600	230/460	215T	Y	U063A	215TTGN6501	✓	10:1	\$2,298	E7	90.2	23.6/11.8	265	22.63
3600		230/460	215T	Y	U063B	215TTGND6501	✓	10:1	\$2,298	E7	90.2	23.8/11.9	252	19.63	25, 68
1800		230/460	215T	Y	U007A	215TTGN6526	✓	10:1	\$2,239	E7	91.7	25.0/12.5	263	22.63	d, 25, 68, 91
1800		230/460	215T	Y	U007B	215TTGND6526	✓	10:1	\$2,239	E7	91.7	26.6/13.3	257	22.63	25, 68, 91
1800		230/460	215T	Y	U992A	215TTGN6539	✓	2:1	\$3,019	E7	91.7	25.0/12.5	253	22.63	d, 25, 68
1800		230/460	215T	Y	U992B	215TTGND6539	✓	2:1	\$3,019	E7	91.7	26.6/13.3	264	22.63	25, 68
1800		230/460	215T	Y	U992A-P	215TTGN16539	✓	2:1	\$3,019	E7	91.7	25.0/12.5	253	22.63	d, 25, 68, P
1800		230/460	215T	Y	U992B-P	215TTGND16539	✓	2:1	\$3,019	E7	91.7	26.6/13.3	270	22.63	25, 68, P
1800		575	215T	N	U026A	215TTGN16532	✓	10:1	\$2,239	E7	91.7	10.0	248	22.63	d, 25
1800		575	215T	N	U026B	215TTGN16532	✓	10:1	\$2,239	E7	91.7	10.7	220	22.63	25
1200		230/460	256T	Y	E501	256TTGN6576	✓	10:1	\$3,386	E7	91.0	26.2/13.1	360	25.27	68
15		3600	230/460	254T	Y	E502	254TTGN6507	✓	10:1	\$2,745	E7	91.7	35.0/17.5	253	23.52
	1800	230/460	254T	Y	E503	254TTGN6531	✓	10:1	\$2,729	E7	92.4	37.5/18.8	385	23.52	68
	1800	230/460	254T	Y	E503-P	254TTGN16549	✓	10:1	\$3,873	E7	92.4	37.5/18.8	385	23.52	68, P
	1800	575	254T	Y	U027A	254TTGN16541	✓	10:1	\$2,729	E7	92.4	15.1	402	23.52	
	1200	230/460	284T	Y	E504	284TTGN6576	✓	10:1	\$4,704	E7	91.7	41.0/20.4	536	26.34	68
20	3600	230/460	256T	Y	E505	256TTGN16509	✓	10:1	\$4,029	E7	92.4	47.0/23.4	275	25.27	68
	1800	230/460	256T	Y	E506	256TTGN6531	✓	10:1	\$3,230	E7	93.0	48.0/24.1	409	25.27	68
	1800	230/460	256T	Y	E506-P	256TTGN16552	✓	10:1	\$3,618	E7	93.0	48.0/24.1	409	25.27	68, P
	1800	575	256T	Y	U028A	256TTGN16540	✓	2:1	\$3,230	E7	93.0	19.3	417	25.27	
	1200	230/460	286T	Y	E507	286TTGN16577	✓	10:1	\$5,485	E7	91.7	53.6/26.8	593	27.69	
25	3600	230/460	284TS	Y	E546	284TSTGN6503	✓	10:1	\$4,465	E7	93.6	56.0/28.1	412	24.97	68
	1800	230/460	284TS	Y	U076A	284TSTGN16531		10:1	\$4,109	E7	93.6	62.0/31.0	484	24.97	68
	1800	230/460	284T	Y	E547	284TTGN6533	✓	10:1	\$4,109	E7	93.6	62.0/31.0	536	26.34	68
	1800	230/460	284T	Y	E547-P	284TTGN16550	✓	10:1	\$4,601	E7	93.6	62.0/31.0	536	26.34	68, P
	1800	575	284T	Y	U029A	284TTGN16539	✓	2:1	\$4,109	E7	93.6	24.8	358	26.34	
	1200	230/460	324T	Y	U048A	324TTGS16577	✓	10:1	\$8,073	E7	93.0	65.0/32.5	681	28.87	68
30	3600	230/460	286TS	Y	E563	286TSTGN6501	✓	10:1	\$4,811	E7	93.6	67.5/34.0	487	26.47	68
	1800	230/460	286TS	Y	U077A	286TSTGN16531		2:1	\$4,764	E7	93.6	73.0/36.5	462	26.47	68
	1800	230/460	286T	Y	E564	286TTGN6537	✓	10:1	\$4,764	E7	94.1	73.0/36.5	588	27.84	68
	1800	230/460	286T	Y	E564-P	286TTGN16546	✓	10:1	\$5,335	E7	94.1	73.0/36.5	588	27.84	68, P
	1800	575	286T	Y	U030A	286TTGN16533	✓	10:1	\$4,764	E7	93.6	29.2	546	27.84	
	1200	230/460	326T	Y	E565	326TTGS6578	✓	10:1	\$8,776	E7	93.0	77.0/38.5	900	30.37	68
40	3600	230/460	324TS	Y	E566	324TSTGS6501	✓	10:1	\$6,476	E7	93.6	94.0/47.0	734	28.87	68
	1800	230/460	324TS	Y	U078A	324TSTGS16531		10:1	\$6,340	E7	94.1	95.0/47.5	770	28.87	17, 68
	1800	230/460	324T	Y	E567	324TTGS6529	✓	10:1	\$6,340	E7	94.1	95.0/47.5	749	30.37	68
	1800	230/460	324T	Y	E567-P	324TTGS16541	✓	10:1	\$7,101	E7	94.1	95.0/47.5	749	30.37	68, P
	1800	575	324T	Y	U031A	324TTGS16535	✓	10:1	\$6,340	E7	94.1	38.0	572	30.37	17
1200	230/460	364T	Y	E568A	364TTGS16577	✓	10:1	\$10,554	E7	93.6	100.0/50.0	1151	31.50	68	

Catalog numbers (Cat No.) highlighted in bold blue are premium efficient.
Blue shaded areas are cast iron frames.

Continued on next page.

HAZARDOUS DUTY® DIVISION 1 EXPLOSION PROOF MOTORS

NEMA® PREMIUM XRI® MOTOR, CLASS I AND II, GROUPS C, D, F & G

BLUE CHIP SERIES® SEVERE DUTY, THREE PHASE MOTORS

RIGID BASE

HP	RPM	VOLTS	FRAME	GROUP C	CAT. NO.	MODEL NO.	STOCK	CT SPEED RANGE	LIST PRICE	MULT. SYMB.	NOM. EFF.	FL. AMPS	WT.	"C" DIM.	FOOT NOTES
50	3600	230/460	326TS	Y	E569	326TSTGS6501	√	10:1	\$8,213	E7	93.6	118.0/59.0	831	30.37	68
	1800	230/460	326TS	Y	U079A	326TSTGS16532		2:1	\$7,721	E7	94.5	120.0/60.0	688	28.87	68
	1800	230/460	326T	Y	E570	326TTGS6532	√	2:1	\$7,721	E7	94.5	123.0/61.5	791	30.37	68
	1800	230/460	326T	Y	E570-P	326TTGS16546	√	2:1	\$8,648	E7	94.5	123.0/61.5	791	30.37	68, P
	1800	575	326T	Y	U032A	326TTGS16539	√	2:1	\$7,721	E7	94.5	49.0	572	30.37	17, 68
	1200	230/460	365T	Y	E571	365TTGS16577	√	2:1	\$11,419	E7	94.5	123.0/61.5	1099	32.50	87
60	3600	230/460	364TS	Y	E572	364TSTGS6506	√	2:1	\$11,930	E7	94.5	134.0/67.0	1033	29.38	87
	1800	230/460	364TS	Y	U080A	364TSTGS16531		2:1	\$11,855	E7	95.0	138.0/69.0	1145	29.38	17, 68
	1800	230/460	364T	Y	E573A	364TTGS16536	√	10:1	\$11,855	E7	95.0	138.0/69.0	1178	31.50	17, 87
	1800	575	364T	Y	U033A	364TTGS16537	√	2:1	\$11,855	E7	95.0	55.0	1161	31.50	
	1200	230/460	404T	Y	E574	404TTGS6588	√	10:1	\$14,259	E7	94.5	144.0/72.0	1295	35.62	
	75	3600	230/460	365TS	Y	E575	365TSTGS16503	√	2:1	\$13,825	E7	94.1	169.0/84.5	1097	30.38
1800		230/460	365T	Y	E576A	365TTGS16540	√	2:1	\$13,759	E7	95.4	174.0/87.0	1124	32.50	68, A
1800		575	365T	Y	U034A	365TTGS16542	√	2:1	\$13,759	E7	95.4	69.0	1094	32.50	A
1800		230/460	365TS	Y	U081A	365TSTGS16532		2:1	\$13,759	E7	95.4	174.0/87.0	1087	30.38	68, A
1200		230/460	405T	Y	E577	405TTGS6589	√	2:1	\$16,604	E7	94.5	180.0/90.0	1388	37.12	87
100		3600	230/460	405TS	Y	E578	405TSTGS6503		10:1	\$18,703	E7	94.5	216.0/108.0	1349	34.12
	1800	230/460	405T	Y	E594	405TTGS6548	√	2:1	\$16,971	E7	95.4	226.0/113.0	1479	37.12	68
	1800	575	405T	Y	U035A	405TTGS16539	√	2:1	\$16,971	E7	95.4	90.5	1365	37.12	68, 87
	1800	230/460	405TS	Y	U082A	405TSTGS16531		2:1	\$16,971	E7	95.4	226.0/113.0	1333	34.12	68, 87
	1200	230/460	444T	Y	E580A	444TTGN16580	√	—	\$23,725	E7	95.0	248.0/124.0	1813	41.35	68, 87
	125	3600	460	444TS	Y	U073A	444TSTGN16502		2:1	\$30,071	E7	94.5	139.0	1824	36.70
1800		460	444T	Y	E582A	444TTGN16532	√	2:1	\$24,908	E7	95.4	143.0	1845	41.35	68
1800		575	444T	Y	U036A	444TTGN16533	√	2:1	\$24,908	E7	95.4	114.0	1808	41.35	
1800		460	444TS	Y	U083A	444TSTGN16531		2:1	\$24,908	E7	95.4	143.0	1835	37.60	
1200		460	445T	Y	E583	445TTGN6597		—	\$27,275	E7	95.0	155.0	2200	43.25	
150		3600	460	445TS	Y	E584	445TSTGN16505		2:1	\$35,199	E7	95.0	168.0	1941	39.60
	1800	460	445T	Y	E585	445TTGN6542	√	2:1	\$25,911	E7	95.4	172.0	2173	43.35	68
	1800	575	445T	Y	U037A	445TTGN16544	√	10:1	\$25,911	E7	95.4	138.0	2236	43.35	
	1800	460	445TS	Y	U084A	445TSTGN16531		10:1	\$25,911	E7	95.4	172.0	2163	39.60	68
	1200	460	445T	Y	U090A	445TTGN16588	√	10:1	\$29,318	E7	95.8	181.0	2384	43.35	68, RB
	200	3600	460	445TS	Y	U075A	445TSTFN16033		—	\$42,949	E7	95.4	226.0	2395	39.60
1800		460	445T	Y	E588	445TTGN6538	√	2:1	\$29,375	E7	96.2	224.0	2500	43.19	68
1800		575	445T	Y	U038A	445TTGN16543	√	2:1	\$29,375	E7	96.2	179.0	2384	43.35	68, RB
1200		460	449T	Y	U091A	449TTGS16585		10:1	\$41,686	E7	95.8	240.0	2878	51.85	68, RB
250	3600	460	449TS	Y	E595A	449TSTGS16506		2:1	\$48,056	E7	95.8	270.0	2750	48.19	17, 68
	1800	460	449T	Y	E591	449TTGS16537	√	10:1	\$36,038	E7	96.5	285.0	3012	51.85	RB
300	1800	460	449T	Y	E596	449TTGS16554		2:1	\$44,308	E7	96.5	339.0	3240	51.85	17, 68, RB
350	1800	460	449T	Y	H504A	449TTGS16557	√	2:1	\$49,719	E7	69.2	395.0	3300	51.85	17, RB

Catalog numbers (Cat No.) highlighted in bold blue are premium efficient.

Blue shaded areas are cast iron frames.

"R164 REWORK" TABLE:

R-164 Rework for 10:1 Constant Torque: Fan Change* & Re-Nameplate

FRAME	LIST PRICE
143-215	\$367
254-286	\$419
324-326	\$472
364-365	\$472
404-449	\$524

MULTIPLIER SYMBOL S4

* Fan change to allow 10:1 constant torque may reduce motor full load efficiency below EAct levels.

Operation of motor on non-sinusoidal wave form exempts motor from EAct mandated efficiency levels.

MEDIUM VOLTAGE MOTORS

Medium Voltage motors are available through 6000 horsepower, and through 13.2 kV (13,200 volts). Enclosures include Dripproof (ODP), WPI, WP11, Totally Enclosed Fan Cooled (TEFC), Totally Enclosed Air-to-Air Cooled (TEAAC) and Totally Enclosed Water-to-Air Cooled (TEWAC). Contact your sales representative for a quotation on any ratings or configurations not listed below.



Medium Voltage ODP / TEFC

Range:
TEFC: 125-2500HP, 90-185 kW
ODP: 125-500HP, 90-3700kW
Voltage: 2300 - 13,800V
Pole: 2-, 4-, 6-, 8-pole
Hertz: 50 or 60 Hertz
Frame: 449T-5013 NEMA®
355-560 IEC
Protection: IP22 to IP56
Insulation: Class F & H VPI
Construction: Fabricated steel or cast iron
Performance: NEMA / IEC
Bearings: Anti-Friction
Service Factor: 1.15
Inverter: Yes
Warranty: 12/18 & 12/24 mo.
UL / CSA

Above NEMA ODP / WPI

Range: 250-3000HP, 185-4600kW
Voltage: 2300 - 13,800V
Pole: 2-, 4-, 6-, pole
Hertz: 50 or 60 Hertz
Frame: 5000-5800 NEMA
355-630 IEC
Protection: IP23
Insulation: Class F VPI
Construction: Fabricated steel
Performance: NEMA / IEC
Bearings: Anti-Friction,
Optional sleeve
Service Factor: 1.15
Inverter: Yes
Warranty: 12/24 mo.
UL / CSA

Above NEMA WP11

Range: 250-6000HP, 185-4600kW
Voltage: 2300 - 13,800V
Pole: 2-, 4-, 6- pole
Hertz: 50 - 60 Hertz
Frame: 5000-5800 NEMA
355-630 IEC
Protection: IPW23
Insulation: Class F VPI
Construction: Fabricated steel
Performance: NEMA / IEC
Bearings: Anti-Friction,
Optional sleeve
Service Factor: 1.15
Inverter: Yes
Warranty: 12/24 mo.
UL / CSA

Above NEMA TEAAC / TEWAC

Range: 300-6000HP, 225-4600kW
Voltage: 2300 - 13,800V
Pole: 2-, 4-, 6- pole
Hertz: 50 - 60 Hertz
Frame: 355-900 IEC
Protection: IP44
Ambient: 40° C
Insulation: Class F VPI
Construction: Fabricated steel
Performance: IEC
Bearings: Anti-Friction
Optional sleeve
Service Factor: 1.15
Inverter: Yes
Warranty: 12/24 mo.
UL / CSA

FEATURES

	DRIPPROOF, 449-510 FRAME	TOTALLY ENCLOSED, 449 FRAME	TOTALLY ENCLOSED, 5000 FRAME
NEMA Premium® efficiencies as noted (Table 12-13)	X	X	X
Cast iron construction B-10 life on direct-coupled loads	X	X	X
Open conrad radial ball bearings rated for 100,000 hour B-10 life on direct-coupled loads	X	X	X
Roller bearing for belted loads	optional	optional	optional
Oversized, fabricated steel conduit box	X		
Oversized, cast iron conduit box		X	X
1.15 Service factor as available (consult factory)	optional	optional	optional
Class H insulation and form wound coils	X	X	X
Epoxy, 100% solids, Vacuum Pressure Impregnation (VPI) resin	X	X	X
Grease fittings with extended grease tubes		X	X
Internal and external epoxy finish		X	X
Front and rear cast iron bearing caps		X	X
Actual test and vibration data included with each order		X	X
CSA Certified for Div. 2/Zone 2, Group A, B, C, D and Group IIA, IIB, IIC		X	X
Temp Code T3 @ 1.0 Service Factor		X	
Temp Code T2C @ 1.0 Service Factor			X
Temp Code T2B @ 1.15 Service Factor		X	X
IEEE-841 features		optional	optional
Provisions for jacking bolts in all four feet			X
Rotating shaft seals, Inpro® Smart Rings on each end			X
Provisions for dowel pins in drive end feet			X
Ground provisions on foot and in the conduit box			X
Dedicated 5009 frame for vertical applications			X
Frames drilled with four sets of footholes, 5009, 5010, 5011, 5012			X

Inpro is believed to be the trademark or trade name of INPRO/SEAL LLC and is not owned or controlled by Regal Beloit Corporation.

NEMA and NEMA Premium are trademarks of National Electrical Manufacturers Association. All Rights Reserved.

Prices and specifications are subject to change without notice.

MEDIUM VOLTAGE MOTORS

MULTIPLIER SYMBOL S6

HP	RPM	DRIPPROOF				TOTALLY ENCLOSED			
		NEMA PREMIUM®	FRAME	CAT. NO.	LIST PRICE	NEMA PREMIUM	FRAME	CAT. NO.	LIST PRICE
100	900	N/A	—	—	—	N/A	447/9T	Y255	\$70,159
125	1800	N/A	—	—	—	N/A	L447/9T	Y256	\$58,716
	1200	N/A	—	—	—	N/A	447/9T	Y257	\$74,330
150	900	N/A	449T	Y948	\$50,610	N/A	5011LS	Y913	\$81,049
	3600	N/A	—	—	—	N/A	447/9TS	Y903	\$64,019
	1800	N/A	—	—	—	N/A	L447/9T	Y900	\$61,145
	1200	N/A	—	—	—	N/A	447/9T	Y904	\$76,964
200	900	N/A	508U	Y949	\$58,394	N/A	5011LS	Y914	\$88,088
	3600	N/A	—	—	—	N/A	L447/9TS	Y905	\$68,107
	1800	N/A	449T	Y950	\$48,788	N/A	L447/9T	Y901	\$65,023
	1200	N/A	449T	Y958	\$53,244	N/A	L447/9T	Y906	\$77,859
250	1200	N/A	—	—	—	N/A	5011LS	Y920	\$79,309
	900	N/A	508U	Y250	\$67,520	N/A	5011LS	Y915	\$92,984
	3600	N/A	449TS	Y954	\$58,893		5011S	Y258	\$84,490
	1800	N/A	449T	Y951	\$51,350	Y	L447/9T	Y902	\$70,685
300	1200	N/A	508U	Y955	\$56,055	Y	L447/9T	Y907	\$86,095
	1200	—	—	—	—	Y	5011LX	Y921	\$88,332
	900	N/A	510U	Y251	\$73,389	N/A	5011LS	Y916	\$95,681
	3600	N/A	449TS	Y956	\$61,224		5011S	Y259	\$87,057
350	1800	—	—	—	—	Y	L447/9T	Y908	\$79,571
	1800	N/A	508U	Y952	\$56,042	Y	5011LS	Y922	\$82,939
	1200	N/A	508U	Y942	\$60,785	Y	5011LS	Y923	\$93,682
	900	N/A	510U	Y252	\$95,078	N/A	5013LS	Y917	\$110,274
400	3600	N/A	449TS	Y957	\$63,578		5011S	Y260	\$88,341
	1800	N/A	508U	Y953	\$58,069	Y	5011LS	Y924	\$84,102
	1200	N/A	508U	Y943	\$65,612	Y	5011LS	Y925	\$97,468
	1200	—	—	—	—	Y	5011LX	Y935	\$102,863
450	900	—	—	—	—	N/A	5013LS	Y918	\$123,565
	3600	N/A	508U	Y910	\$69,897		5011S	Y261	\$97,378
	1800	Y	508U	Y940	\$60,059	Y	5011LS	Y926	\$89,956
	1800	—	—	—	—	Y	5011LX	Y936	\$95,306
500	1200	Y	510U	Y944	\$81,585	Y	5011LS	Y927	\$106,942
	900	—	—	—	—	N/A	5013LS	Y912	\$148,818
	3600	—	—	—	—		5011S	Y263	\$100,639
	1800	Y	508US	Y911	\$71,282	Y	5011LS	Y928	\$95,814
600	1800	Y	510U	Y941	\$64,802	Y	5011LX	Y937	\$101,161
	1200	Y	510U	Y945	\$95,709	Y	5013LS	Y929	\$116,109
	900	—	—	—	—	N/A	5013LS	Y262	\$154,077
	1800	Y	510U	Y946	\$78,843	Y	5011LS	Y930	\$105,393
700	1800	—	—	—	—	Y	5011LX	Y938	\$110,744
	1200	Y	510U	Y947	\$116,650	Y	5013LS	Y931	\$123,912
	1800	N/A	510U	Y253	\$96,208	N/A	5011LS	Y932	\$138,393
800	1800	—	—	—	—	N/A	5011LX	Y939	\$143,743
	1800	N/A	510U	Y254	\$101,226	N/A	5013LS	Y933	\$148,010
800	1800	—	—	—	—	N/A	5013LS	Y934	\$158,773

MEDIUM VOLTAGE

NEMA Premium is a trademark of National Electrical Manufacturers Association. All Rights Reserved.

Prices and specifications are subject to change without notice.

INVERTER (VECTOR) DUTY: MICROMAX® MOTORS

1000:1 CONSTANT TORQUE (TENV),
 20:1 CONSTANT TORQUE (TEFC)
 TOTALLY ENCLOSED, THREE PHASE MOTORS

APPLICATIONS:

Designed for direct replacement of PMDC or any other variable speed application where up to a 1000:1 constant torque speed range is required. Typical uses include: machine tools, conveyors, packaging machines, batching machines, and printing equipment.



FEATURES:

- Designed to replace PMDC motors (when used with a VFD)
- Constant horsepower to twice base speed (RPM)
- Class H insulation with CR200 corona resistant magnet wire
- Removable base for C-Face footless mounting, as noted
- Continuous duty at 40°C ambient
- “Quick Connect” terminal board, as noted
- Top mounted conduit box as found on PMDC motors
- Eliminates brush and commutator maintenance
- UL recognized, CSA certified, and CE mark
- Three year warranty

C-FACE FOOTLESS

HP	RPM	VOLTS	FRAME	CAT. NO.	MODEL NO.	STOCK	LIST PRICE	MULT. SYMB.	FL. AMPS	WT.	“C” DIM.	FOOT NOTES
1/8	1800	230	56C	Y606	056H17T2022	√	\$375	E3	0.7	15	9.16	N, Q
1/4	1800	230	56C	Y501	056H17T2012	√	\$405	E3	1.0	16	9.91	N, Q
1/3	1800	230	56C	Y503	056H17T2014	√	\$437	E3	1.2	17	9.91	N, Q
1/2	1800	230	56C	Y505	056H17T2016	√	\$513	E3	1.8	24	9.91	N, Q
	1800	230/460	56C	Y374	056H17T2018	√	\$513	E3	1.8/0.9	24	9.91	N
	1800	575	56C	Y375	056H17T2020		\$513	E3	0.7	24	9.91	N, Q
3/4	1800	230	56C	Y507	056H17F2012		\$634	E3	2.8	21	11.19	
	1800	230/460	56C	Y376	056H17F2018	√	\$634	E3	2.8/1.4	21	11.19	
	1800	575	56C	Y377	056H17F2016		\$634	E3	1.1	21	11.19	
1	1800	230	56C	Y521	056H17F2014		\$714	E3	3.2	27	12.44	
	1800	230/460	56C	Y378	056H17F2022	√	\$714	E3	3.2/1.6	27	12.44	
	1800	575	56C	Y379	056H17F2020		\$714	E3	1.3	27	12.44	

C-FACE FOOTED (RIGID BASE)

HP	RPM	VOLTS	FRAME	CAT. NO.	MODEL NO.	STOCK	LIST PRICE	MULT. SYMB.	FL. AMPS	WT.	“C” DIM.	FOOT NOTES
1/8	1800	230	56C	Y605	056H17T2021	√	\$375	E3	0.7	18	9.16	N, Q
1/4	1800	230	56C	Y500	056H17T2011	√	\$405	E3	1.0	17	9.91	N, Q
1/3	1800	230	56C	Y502	056H17T2013	√	\$437	E3	1.2	17	9.91	N, Q
1/2	1800	230	56C	Y504	056H17T2015	√	\$513	E3	1.8	22	9.91	N, Q
	1800	230/460	56C	Y360	056H17T2017	√	\$513	E3	1.8/0.9	22	9.91	N
	1800	575	56C	Y361	056H17T2019		\$513	E3	0.7	22	9.91	N, Q
3/4	1800	230	56C	Y506	056H17F2011	√	\$634	E3	2.8	24	11.19	
	1800	230/460	56C	Y362	056H17F2017	√	\$634	E3	2.8/1.4	24	11.19	
	1800	575	56C	Y363	056H17F2015	√	\$634	E3	1.1	24	11.19	
1	1800	230	56C	Y508	056H17F2013		\$714	E3	3.2	28	12.44	
	1800	230/460	56C	Y364	056H17F2021	√	\$714	E3	3.2/1.6	28	12.44	
	1800	575	56C	Y365	056H17F2019	√	\$714	E3	1.3	28	12.44	
1 1/2	1800	230	145TC	Y522	145THTR5328	√	\$888	E3	4.8	48	13.48	N, 6
	1800	230/460	145TC	Y366	145THTR5329	√	\$888	E3	4.8/2.4	48	13.48	N, 6
	1800	575	145TC	Y367	145THTR5330		\$888	E3	1.9	48	13.48	N, 6
2	1800	230	145TC	Y523	145THFR5326		\$1,178	E3	5.8	53	14.95	6
	1800	230/460	145TC	Y368	145THFR5329	√	\$1,178	E3	5.8/2.9	53	14.95	6
	1800	575	145TC	Y369	145THFR5330	√	\$1,178	E3	2.3	53	14.95	6

Continued on next page.

INVERTER (VECTOR) DUTY: MICROMAX™ MOTORS

1000:1 CONSTANT TORQUE (TENV),
20:1 CONSTANT TORQUE (TEFC)
TOTALLY ENCLOSED, THREE PHASE MOTORS

C-FACE FOOTED (RIGID BASE)

HP	RPM	VOLTS	FRAME	CAT. NO.	MODEL NO.	STOCK	LIST PRICE	MULT. SYMB.	F.L. AMPS	WT.	"C" DIM.	FOOT NOTES
3	1800	230/460	182TCZ	Y370	182THFR5329	√	\$1,388	E3	8.4/4.2	52	14.87	88, 99
	1800	230/460	182TC	Y1999	182THFW7729	√	\$1,449	E3	8.4/4.2	64	13.97	6, 13
	1800	575	182TCZ	Y371	182THFR5330		\$1,388	E3	3.4	52	14.87	88, 99
	1800	575	182TC	Y270A	182THFW7730		\$1,449	E3	2.9	86	14.97	6, 13
5	1800	230/460	184TC	Y1372	184THFW7726	√	\$1,648	E3	13.0/6.5	92	13.97	6, 13
	1800	575	184TC	373A	184THFW7736	√	\$1,648	E3	5.2	95	13.97	6, 13
7 1/2	1800	230/460	213TC	Y994	213THFW7726	√	\$2,107	E3	21.4/10.7	128	20.97	6
	1800	575	213TC	Y995	213THFW7736		\$2,107	E3	8.5	128	20.97	6
10	1800	230/460	215TC	Y996	215THFW7726	√	\$2,695	E3	27.6/13.8	157	22.22	6
	1800	575	215TC	Y997	215THFW7736		\$2,695	E3	11.1	157	22.22	6

INVERTER (VECTOR) DUTY: MICROMAX PLUS MOTORS

1000:1 CONSTANT TORQUE (TENV), WITH ENCODER

ADDITIONAL FEATURES:

- Integrated Dynapar® HS20 1024 ppr encoder
- Class F insulation with CR²⁰⁰ corona resistant magnet wire
- Constant torque operation from 0 to base speed on vector drive
- F1 conduit box, field reversible to F2 (except as noted)

MAX 



C-FACE FOOTED (RIGID BASE)

HP	RPM	VOLTS	FRAME	CAT. NO.	MODEL NO.	STOCK	LIST PRICE	MULT. SYMB.	F.L. AMPS	ENCODER PPR	WT.	"C" DIM.	FOOT NOTES
1/2	1800	230/460	56C	Y280	056H17T15526	√	\$1,581	E3	1.6/8	1024	29	13.74	
3/4	1800	230/460	56C	Y281	056H17T15528	√	\$1,654	E3	2.4/1.2	1024	35	14.24	
1	1800	230/460	56C	Y282	056H17T15527	√	\$1,752	E3	3.0/1.5	1024	41	15.24	
	1800	230/460	143TC	Y283	143THTR15535	√	\$1,885	E3	3.0/1.5	1024	42	15.04	
1 1/2	1800	230/460	145TC	Y284	145THTR15540	√	\$2,085	E3	4.8/2.4	1024	50	16.04	
2	1800	230/460	145TC	Y285	145HTN17034	√	\$2,797	E3	6.0/3.0	1024	75	14.93	
3	1800	230/460	182TC	Y286A	182THTY17041	√	\$3,143	E3	8.2/4.1	1024	80	16.19	AL
5	1800	230/460	184TC	Y287A	184THTY17038	√	\$3,422	E3	13.4/6.7	1024	93	17.69	AL

Blue shaded areas are cast iron frames.

INVERTER DUTY

INVERTER (VECTOR) DUTY: BLACK MAX® MOTORS

1000:1 CONSTANT TORQUE TENV, THREE PHASE MOTORS



APPLICATIONS:

Designed for inverter or vector applications where up to a 1000:1 constant torque speed range is required. Typical uses include: material handling, machine tools, conveyors, crane and hoist, metal processing, test stands, pumps compressors, textile processing, and other industrial machinery installed in dusty or dirty environments.

FEATURES:

- MAX GUARD® Class F insulation system
- Constant torque operation from 0 to base speed on vector drive
- Constant horsepower operation up to twice base RPM
- Continuous duty at 40°C ambient
- Optimized for operation with IGBT inverter (NEMA® Design A)
- Normally closed thermostats (one per phase, Class F)
- Removable rigid base, as noted
- Ball bearings
- Field reversible to F2 (except as noted)
- Encoder and brake provisions included on opposite drive end (maximum 10 lb-ft brake, see modifications and/or accessory kits sections)
- UL recognized, CSA certified, and CE mark
- Three year warranty

C-FACE FOOTED (RIGID BASE)

HP	RPM	VOLTS	FRAME	OVER LOAD	CAT. NO.	MODEL NO.	STOCK	LIST PRICE	MULT. SYMB.	FL. AMPS	WT.	"C" DIM.	FOOT NOTES
1/4	1800	230/460	56C	TSTAT	Y592	056H17T2001	√	\$594	E3	1.2/0.6	19	11.88	S, 13
1/2	1800	230/460	56C	TSTAT	Y534	056H17T5301	√	\$744	E3	1.6/0.8	35	13.48	S, 6, 13
	1800	575	56C	TSTAT	Y555	056H17T5311	√	\$744	E3	0.6	35	13.48	S, 6, 13
1	1800	230/460	56C	TSTAT	Y535	056H17T5302	√	\$888	E3	3.0/1.5	39	14.98	S, 6, 13
	1800	575	56C	TSTAT	Y556	056H17T5312	√	\$888	E3	1.2	39	14.98	S, 6, 13
	1800	230/460	143TC	TSTAT	Y536	143THTR5326	√	\$912	E3	3.0/1.5	48	15.04	S, 6, 13
	1200	230/460	145TC	TSTAT	Y537	145THTR5376	√	\$1,057	E3	3.8/1.9	49	16.04	S, 6, 13
1 1/2	1800	230/460	145TC	TSTAT	Y538	145THTR5326	√	\$1,108	E3	4.8/2.4	50	16.04	S, 6, 13
2	1800	230/460	145TC	TSTAT	Y612	145THTR16032	√	\$1,426	E3	6.0/3.0	65	16.04	S, 6, 13
	1800	230/460	145TC	TSTAT	Y551	145THTN6046	√	\$1,530	E3	6.0/3.0	73	14.68	
	1800	575	145TC	TSTAT	Y611	145THTR16031	√	\$1,426	E3	2.4	65	16.04	S, 6, 13
	1800	575	145TC	TSTAT	Y557	145THTN6060	√	\$1,530	E3	2.4	73	14.68	
3	1200	230/460	184TC	TSTAT	Y540	184THTL7776	√	\$2,188	E3	6.6/3.3	88	16.93	AL
	1800	230/460	182TC	TSTAT	Y541A	182THTY7726	√	\$1,897	E3	8.2/4.1	77	16.19	AL
	1800	575	182TC	TSTAT	Y558	182THTL7736	√	\$1,897	E3	3.4	95	17.39	d, AL
	1800	575	182TC	TSTAT	Y558A	182THTY7736	√	\$1,897	E3	3.4	89	16.19	AL
	1200	230/460	213TC	TSTAT	Y542	213THTL7776	√	\$2,695	E3	9.4/4.7	118	19.04	AL
5	1800	230/460	184TC	TSTAT	Y543	184THTL7726	√	\$2,265	E3	14.0/7.0	110	18.93	d, AL
	1800	230/460	184TC	TSTAT	Y543A	184THTY7726	√	\$2,265	E3	13.4/6.7	92	17.69	AL
	1800	575	184TC	TSTAT	Y559A	184THTY7736	√	\$2,265	E3	5.4	96	17.69	AL
	1200	230/460	215TC	TSTAT	Y544	215THTL7776	√	\$3,278	E3	15.4/7.7	146	20.54	AL
7 1/2	1800	230/460	213TC	TSTAT	Y545	213THTL7726	√	\$2,972	E3	21.0/10.5	146	20.54	AL
	1800	575	213TC	TSTAT	Y560	213THTL7736	√	\$2,972	E3	8.4	146	20.54	AL
	1200	230/460	254TC	TSTAT	Y546	254THTL5776	√	\$4,410	E3	22.0/11.0	223	25.37	AL, I
10	1800	230/460	215TC	TSTAT	Y547	215THTL7726	√	\$3,556	E3	27.0/13.5	219	23.04	AL
	1800	575	215TC	TSTAT	Y561	215THTL7736	√	\$3,556	E3	10.8	219	23.04	AL
	1200	230/460	256TC	TSTAT	Y548	256THTL5776	√	\$4,992	E3	28.0/14.0	229	26.87	AL, I
15	1800	230/460	254TC	TSTAT	Y549	254THTL5726	√	\$4,231	E3	40.0/20.0	260	26.87	AL, I
	1800	575	254TC	TSTAT	Y562	254THTL5736	√	\$4,231	E3	16.0	260	26.87	AL, I

Contact Regal for other base speeds and options not shown in this catalog.
Blue shaded areas are cast iron frames.

Continued on next page.

INVERTER (VECTOR) DUTY: BLACK MAX® MOTORS

1000:1 CONSTANT TORQUE TENV, THREE PHASE

C-FACE FOOTED (RIGID BASE)

HP	RPM	VOLTS	FRAME	OVER LOAD	CAT. NO.	MODEL NO.	STOCK	LIST PRICE	MULT. SYMB.	F.L. AMPS	WT.	"C" DIM.	FOOT NOTES
20	1800	230/460	256TC	TSTAT	Y552	256THTNA7026	√	\$6,177	E3	52.0/26.0	300	27.13	
	1800	575	256TC	TSTAT	Y563	256THTNA7036	√	\$6,177	E3	20.8	300	27.13	
25	1800	230/460	284TC	TSTAT	Y553	284THTNA7026	√	\$6,719	E3	62.0/31.0	379	27.08	I
	1800	575	284TC	TSTAT	Y567	284THTNA7036	√	\$6,719	E3	24.8	379	27.08	I
30	1800	230/460	286TC	TSTAT	Y393	286THTNA7026	√	\$7,577	E3	74.0/37.0	575	28.58	I
	1800	575	286TC	TSTAT	Y394	286THTNA7036	√	\$7,577	E3	29.6	575	28.58	I

Contact Regal for other base speeds and options not shown in this catalog.
Blue shaded areas are cast iron frames.

INVERTER (VECTOR) DUTY: BLACK MAX HAZARDOUS DUTY® MOTORS

1000:1 CONSTANT TORQUE, EXPLOSION PROOF, THREE PHASE CLASS I AND II (GASES AND DUST), GROUPS C, D, F & G, TENV MOTORS

APPLICATIONS:

For use in material handling, machine tools, conveyors, crane & hoist, and other variable speed applications requiring up to 1000:1 constant torque speed range, to be installed in hazardous environments as defined by the motor's explosion proof class and group rating. Refer to the General Information sections contained in this catalog for information on explosion proof classifications. Consult the National Electrical Code and your local regulations for the proper selection of motors in hazardous locations.



FEATURES:

- MAX GUARD® Class F insulation system
- Constant torque operation from 0 to base speed on vector drive
- Constant horsepower operation up to twice base RPM
- Continuous duty at 40°C ambient
- Optimized for operation with IGBT inverter (NEMA® Design A)
- Normally closed thermostats (one per phase, Class F)
- Ball bearings
- Top mount (F3) conduit box included, shipped loose
- No encoder provisions provided
- Meets temperature code T3B
- UL listed, under file #E12044
- CSA certified, under file numbers LR47504 and LR21839
- Three year warranty

C-FACE FOOTED (RIGID BASE)

HP	RPM	VOLTS	FRAME	OVER LOAD	CAT. NO.	MODEL NO.	STOCK	LIST PRICE	MULT. SYMB.	F.L. AMPS	WT.	"C" DIM.	FOOT NOTES
1/4	1800	230/460	56C	TSTAT	Y600	056H17E5301	√	\$886	E3	1.1/0.55	26	11.97	
1/3	1800	230/460	56C	TSTAT	Y601	056H17E5302	√	\$1,039	E3	1.2/0.6	26	11.97	
1/2	1800	230/460	56C	TSTAT	Y602	056H17E5303	√	\$1,120	E3	1.6/0.8	31	12.47	
3/4	1800	230/460	56C	TSTAT	Y603	056H17E5304	√	\$1,240	E3	2.4/1.2	38	13.47	
1	1800	230/460	56C	TSTAT	Y604	056H17E5305	√	\$1,358	E3	3.0/1.5	43	13.97	

Contact Regal for other base speeds and options not shown in this catalog.

INVERTER (VECTOR) DUTY: BLUE MAX® 2000 MOTORS

2000:1 CONSTANT TORQUE, TOTALLY ENCLOSED, THREE PHASE MOTORS

APPLICATIONS:

Designed for inverter or vector applications where up to a 2000:1 constant torque speed range is required. Typical uses include: material handling, machine tools, conveyors, crane and hoist, metal processing, test stands, pumps compressors, textile processing, and other industrial machinery installed in dusty or dirty environments where cast iron construction is required.



FEATURES:

- MAX GUARD® Class F insulation system
- Constant torque operation from 0 to base speed on vector drive, including TEFC (On volts/hertz drives, TEFC motors are limited to 20:1 constant torque)
- Constant HP operation to twice base speed (143-256 frame); 1.5 times base (all others)
- Optimized for operation with IGBT inverter
- Bearing current protection (BCP), mounted internally
- C-Face foot mount through 100 HP, as noted
- Normally closed thermostats (one per phase, Class F)
- Continuous duty at 40° C ambient
- 1.0 service factor ("B" rise on TEBC motors)
- Blue Chip Series® quality, cast iron frame and brackets
- Patented "fracket" design (TEBC enclosure)
- Ball bearings (roller bearing available 360 frame & larger)
- Field reversible to F2
- Encoder provisions included on opposite drive end (see modification and/or accessory kits sections)
- UL recognized, CSA certified, and CE mark
- Three year warranty

RIGID BASE AND C-FACE FOOTED (RIGID BASE)

HP	RPM	VOLTS	ENCL.	FRAME	CAT. NO.	MODEL NO.	STOCK	LIST PRICE	MULT. SYMB.	FL. AMPS	WT.	"C" DIM.	FOOT NOTES
1	1800	230/460	TENV	143TC	Y525	143THTN8028	✓	\$1,599	E3	3.0/1.5	61	13.68	B
1 1/2	1800	230/460	TENV	145TC	Y590	145THTN8037	✓	\$1,607	E3	4.6/2.3	65	14.68	
2	1800	230/460	TENV	145TC	Y526	145THTN8029	✓	\$1,731	E3	6.0/3.0	71	14.68	
3	1800	230/460	TENV	182TC	Y527	182THTS8028	✓	\$2,174	E3	8.0/4.0	113	16.68	
5	1800	230/460	TENV	184TC	Y564	184THTS8028	✓	\$2,430	E3	13.4/6.7	147	17.68	
7 1/2	1800	230/460	TEFC	213TC	Y595	213THFS8028	✓	\$2,843	E3	19.4/9.7	192	21.03	
	1800	230/460	TENV	213TC	Y565	213THTS8038	✓	\$3,275	E3	21.0/10.5	212	20.56	
10	1800	230/460	TEFC	215TC	Y596	215THFS8029	✓	\$3,393	E3	25.4/12.7	212	22.53	
	1800	230/460	TENV	215TC	Y566	215THTS8038	✓	\$3,884	E3	26.0/13.0	272	22.74	
15	1800	230/460	TEFC	254TC	Y597	254THFNA8038	✓	\$4,093	E3	37.0/18.5	350	26.34	
	1800	230/460	TENV	254TC	Y509	254THTNA8058	✓	\$4,649	E3	40.4/20.2	334	23.38	
	1200	230/460	TEBC	284TC	Y395	284THFPA8086	✓	\$9,121	E3	40.0/20.0	500	37.48	BP
20	1800	230/460	TEFC	256TC	Y598	256THFNA8038	✓	\$4,528	E3	52.0/26.0	377	28.09	
	1800	230/460	TENV	256TC	Y510	256THTNA8038	✓	\$4,649	E3	52.0/26.0	425	27.13	
	1200	230/460	TEBC	286TC	Y582	286THFPA8086	✓	\$11,792	E3	52.4/26.2	660	38.98	BP
25	1800	230/460	TEFC	284T	Y569	284THFPA8028	✓	\$5,655	E3	63.0/31.5	393	28.58	
	1800	230/460	TEBC	284TC	Y511	284THFPA8038	✓	\$7,903	E3	63.0/31.5	470	37.48	BP
	1200	230/460	TEBC	324TC	Y583	324THFPA8086	✓	\$13,870	E3	67.0/33.5	633	40.41	B, BP
30	1800	230/460	TEFC	286T	Y570	286THFNA8028	✓	\$6,464	E3	77.0/38.5	371	29.91	
	1800	230/460	TEBC	286TC	Y512	286THFPA8038	✓	\$8,713	E3	74.0/37.0	507	38.98	BP
	1200	230/460	TEBC	326TC	Y584	326THFPA8086	✓	\$15,259	E3	80.4/40.2	550	41.91	B, BP
40	1800	230/460	TEFC	324T	Y571	324THFPA8028	✓	\$8,370	E3	100.0/50.0	545	30.71	
	1800	230/460	TEBC	324TC	Y513	324THFPA8038	✓	\$10,437	E3	100.0/50.0	531	40.41	BP
	1200	230/460	TEBC	364TC	Y585	364THFS8391	✓	\$18,406	E3	107.0/53.5	1011	42.67	BP
50	1800	230/460	TEFC	326T	Y572	326THFS8028	✓	\$10,355	E3	121.0/60.5	765	32.44	
	1800	230/460	TEBC	326TC	Y514	326THFPA8038	✓	\$11,966	E3	120.0/60.0	686	41.91	BP
	1200	230/460	TEBC	365TC	Y586	365THFS8380	✓	\$22,065	E3	130.0/65.0	1081	43.78	BP
60	1800	230/460	TEFC	364T	Y573	364THFS8036	✓	\$13,348	E3	147.0/73.5	987	33.7	
	1800	230/460	TEBC	364TC	Y515	364THFS8046	✓	\$14,648	E3	147.0/73.5	1062	42.67	BP
	1200	230/460	TEBC	404TC	Y587	404THFS8092	✓	\$24,477	E3	142.0/71.0	1339	48.22	BP
75	1800	230/460	TEFC	365T	Y574	365THFS8036	✓	\$15,120	E3	184.0/92.0	1061	34.69	
	1800	230/460	TEBC	365TC	Y516	365THFS8046	✓	\$17,511	E3	180.0/90.0	1129	43.67	BP
	1200	230/460	TEBC	405TC	Y588	405THFS8378	✓	\$29,284	E3	180.0/90.0	1387	49.72	B, BP

Blue shaded areas are cast iron frames.

Continued on next page.

INVERTER (VECTOR) DUTY: BLUE MAX® 2000 MOTORS

2000:1 CONSTANT TORQUE, TOTALLY ENCLOSED, THREE PHASE MOTORS

RIGID BASE AND C-FACE FOOTED (RIGID BASE)

HP	RPM	VOLTS	ENCL	FRAME	CAT. NO.	MODEL NO.	STOCK	LIST PRICE	MULT. SYMB.	FL. AMPS	WT.	"C" DIM.	FOOT NOTES
100	1800	230/460	TEFC	405T	Y575	405THFS8036	✓	\$20,461	E3	230/115	1308	39.32	
	1800	230/460	TEBC	405TC	Y517	405THFS8046	✓	\$24,443	E3	230/115	1529	49.72	BP
	1200	230/460	TEBC	444TC	Y589	444THFN8384	✓	\$34,231	E3	250/125	2117	52.72	BP
125	1800	460	TEFC	444T	Y576	444THFN8036	✓	\$26,928	E3	143	2053	43.27	
	1800	460	TEBC	444T	Y518	444THFN8046	✓	\$31,150	E3	138	2010	52.72	B, BP
150	1800	460	TEFC	445T	Y577	445THFN8036	✓	\$31,089	E3	170	2247	45.27	
	1800	460	TEBC	445T	Y519	445THFN8046	✓	\$35,310	E3	170	2310	54.72	BP
200	1800	460	TEFC	445T	Y578	445THFN8040	✓	\$37,528	E3	230	2388	45.27	
	1800	460	TEBC	445T	Y520	445THFN8050	✓	\$41,748	E3	230	2430	54.72	BP
250	1800	460	TEFC	449T	Y579	449THFS8036	✓	\$46,745	E3	280	2900	53.89	CT
	1800	460	TEBC	449T	Y531	449THFS8046	✓	\$52,293	E3	295	2991	63.21	BP
300	1800	460	TEFC	449T	Y580	449THFS8037	✓	\$53,225	E3	330	3077	53.89	CT
	1800	460	TEBC	449T	Y532	449THFS8047	✓	\$58,771	E3	327	2950	63.21	BP
350	1800	460	TEBC	449T	Y533	449THFS8048	✓	\$64,321	E3	385	3099	63.21	BP

Blue shaded areas are cast iron frames.

INVERTER (VECTOR) DUTY: BLUE MAX® 2000 HAZARDOUS DUTY® (WITH ENCODER) 2000:1 CONSTANT TORQUE MOTORS

EXPLOSION PROOF, THREE PHASE

CLASS I AND II (GASES AND DUST), GROUPS C (AS NOTED), D, F & G, TENV MOTORS

APPLICATIONS:

Designed for industrial applications with vector drives where up to a 2000:1 constant torque speed range and/or precise speed or torque regulation is required, including positioning equipment. Used in dirty, dusty or caustic environments where cast iron construction is required, and installed in hazardous environments as defined by the motor's explosion proof class and group rating. Consult the National Electrical Code and your local regulations for the proper selection of motors in hazardous locations.

FEATURES:

- BEI* H38 explosion proof encoder 1024 ppr, Class I Groups C & D, Class II Groups E, F, G included
- MAX GUARD® Class F insulation system
- Constant torque operation from 0 to base speed on vector drive
- Constant HP operation up to twice base speed
- Continuous duty at 40°C ambient
- Optimized for operation with IGBT inverter (NEMA® design A)
- Normally closed thermostats (one per phase, Class F)
- Ball bearings
- Cast iron frame and brackets
- F1 standard, NOT field reversible to F2
- UL listed file no. E12044, MC228275
- CSA certified file no. LR47504, MC236833
- Meets temperature code T3B
- Three year warranty



C-FACE FOOTED (RIGID BASE)

HP	RPM	VOLTS	FRAME	OVER LOAD	CAT. NO.	MODEL NO.	STOCK	LIST PRICE	MULT. SYMB.	FL. AMPS	WT.	"C" DIM.	FOOT NOTES
1	1800	230/460	143TC	TSTAT	Y978	143THEN8034	✓	\$9,260	E3	3.0/1.5	86	21.44	CD
2	1800	230/460	145TC	TSTAT	Y979	145THEN8034	✓	\$9,454	E3	5.8/2.9	90	21.44	CD
3	1800	230/460	182TC	TSTAT	Y980	182THES8048	✓	\$9,759	E3	8.2/4.1	117	24.82	CD
5	1800	230/460	213TC	TSTAT	Y981	213THES8053	✓	\$10,267	E3	13.0/6.5	240	26.17	
7 1/2	1800	230/460	254TC	TSTAT	Y982	254THEN8058	✓	\$11,676	E3	22.0/11.0	344	30.20	CD
10	1800	230/460	254TC	TSTAT	Y983	254THEN8059	✓	\$12,232	E3	27.0/13.5	376	30.20	CD
15	1800	230/460	256TC	TSTAT	Y984	256THEN17031	✓	\$12,788	E3	36.0/18.0	432	31.95	CD
20	1800	230/460	284TC	TSTAT	Y985	284THEN8032	✓	\$14,116	E3	53.0/26.5	555	33.16	CD

Blue shaded areas are cast iron frames.

*BEI is believed to be the trademark or trade name of Custom Sensors & Technology, Inc. and is not owned or controlled by Regal Beloit Corporation.
NEMA is a trademark of National Electrical Manufacturers Association. All Rights Reserved.

Prices and specifications are subject to change without notice.

INVERTER (VECTOR) DUTY: BLUE MAX® 2000 BRAKE MOTORS

2000:1 CONSTANT TORQUE, TENV, THREE PHASE MOTORS

APPLICATIONS:

Designed for vector applications where up to a 2000:1 constant torque speed range is required. For use on conveyors, machine tools, cranes, hoists, and other industrial machinery requiring quick stop and/or holding torque.



FEATURES:

- MAX GUARD® Class F insulation system
- Constant torque operation from 0 to base speed on vector drive
- Constant HP operation to twice base speed
- Optimized for operation with IGBT inverter (NEMA® design A)
- Normally closed thermostats (one per phase, Class F)
- Ball bearings
- Continuous duty at 40°C ambient
- Will accept encoder through Mod Central (see mod 24 for encoder mounting)
- Stearns* brakes, 56 series through 15 Lb-Ft, 87 series, 25 Lb-Ft and larger
- Includes 140% rated spring-set self-adjusting NEMA 2 disk brake (Brake coil voltage matches motor)
- Universal mounting up to 15 Lb-Ft, (see comment below and Mod Central for vertical mounting)
- Horizontal mounting (see comment below and Mod Central for vertical mounting)
- UL recognized, CSA certified, and CE mark
- Three year warranty (brake disks are exempt)

C-FACE FOOTED (RIGID BASE)

HP	RPM	VOLTS	FRAME	CAT. NO.	MODEL NO.	STOCK	LIST PRICE	MULT. SYMB.	F.L. AMPS	WT.	"C" DIM.	TORQUE RATING (LB/FT)
1	1800	230/460	143TC	Y986	143THTN8036	✓	\$2,889	E3	3.0/1.5	72	17.00	6
2	1800	230/460	145TC	Y987	145THTN8043	✓	\$3,218	E3	6.0/3.0	83	18.00	10
3	1800	230/460	182TC	Y988	182THTS8048	✓	\$4,214	E3	8.2/4.1	118	19.67	15
5	1800	230/460	184TC	Y989	184THTS8056	✓	\$5,079	E3	13.4/6.7	161	25.58	25
7 1/2	1800	230/460	213TC	Y990	213THTS8071	✓	\$6,365	E3	21.0/10.5	256	27.58	35
10	1800	230/460	254TC	Y991	215THTS8071	✓	\$7,564	E3	26.0/13.0	302	28.83	50
15	1800	230/460	254TC	Y992	254THTNA8071	✓	\$9,612	E3	40.5/20.2	384	31.53	75
20	1800	230/460	256TC	Y993	256THTNA8071	✓	\$12,740	E3	52.0/26.0	427	33.28	105

Blue shaded areas are cast iron frames.

1024 PPR ENCODERS THROUGH MOD CENTRAL

Multiplier Symbol E3

BRAND	MODEL	CAT. NO.	KIT NUMBER	STOCK	LIST (KIT ONLY)	LIST (INSTALLED)	FITS BRAKEMOTOR CAT. NO.	WT.
Avtron*	AV56	A748	KIT M561024BRK-140	✓	\$3,639	\$3,975	Y986, Y987	4
		A749	KIT M561024BRK-182	✓	\$3,639	\$3,975	Y988	4
	AV85	A750	KIT M851024BRK-184	✓	\$4,909	\$5,245	Y989	5
		A751	KIT M851024BRK-210	✓	\$4,909	\$5,245	Y990, Y991	8
		A752	KIT M851024BRK-250	✓	\$4,909	\$5,245	Y992, Y993	8
		NorthStar*	ST56	A786	KIT LKSR-CFACE	✓	\$4,000	\$4,336
A789	KIT SL561024-182NV			✓	\$4,000	\$4,336	Y988	4
ST85	A790		KIT SL851024-184NV	✓	\$4,909	\$5,245	Y989	8
	A791		KIT SL851024-210NV	✓	\$4,909	\$5,245	Y990, Y991	8
	A792		KIT SL851024-250NV	✓	\$4,909	\$5,245	Y992, Y993	8

VERTICAL MODIFICATION KIT (STEARNS 87,000 SERIES)

- Includes required hardware to accommodate vertical above (shaft down) or vertical below (shaft up) mounting.

TORQUE RATING (LB/FT)	MOUNTING		CAT. NO.	STOCK	MODEL NO.	LIST (KITS ONLY)	LIST INSTALLED	W.T
	SHAFT UP	SHAFT DOWN						
25,35	Not req'd	Required	A157	✓	KIT VRT87BRK	\$669	\$1005	3
50,75,105	Required	Required						

Multiplier Symbol E3

*Northstar is believed to be a registered trade name of Danaher Corporation and is not owned or controlled by Regal Beloit Corporation.

*Avtron is believed to be a registered trade name of Avtron Manufacturing and is not owned or controlled by Regal Beloit Corporation.

*Stearns is believed to be the trademark or trade name of Rexnord Industries, LLC and is not owned or controlled by Regal Beloit Corporation.

NEMA is a trademark of National Electrical Manufacturers Association. All Rights Reserved.

Prices and specifications are subject to change without notice.

SYMAX®-I PMAC MOTORS

TEAO, THREE PHASE

APPLICATIONS:

Condenser fan. These motors need to be mounted within the airflow of the fan for proper cooling.

FEATURES:

- High efficiency over wide RPM range
- Integrated electronic control programmed for constant speed
- Built-in intelligence and electronic protection
- Multiple speed/HP operations (3-Speeds)
- Class F insulation system
- UL and CSA recognition
- Permanent magnet rotor
- IP54 ingress protection
- Reliable ball bearings (6205 on both ends)
- 60° degrees C ambient
- Heavy duty rolled steel construction
- Accommodates smaller frame size, lighter weight
- 4 Locating screws 90 degrees apart



BENEFITS:

- Drop in replacement for 56-Frame induction motors
- Suitable for outdoor environments, longer service life
- Noise reduction
- Easy installation
- Lower operation cost

ROUND FRAME

HP	RPM	VOLTS	FRAME	CAT. NO.	MODEL NO.	STOCK	LIST PRICE	MULT. SYMB.	NOM. EFF.	F.L. AMPS	WT.	"C" DIM.
3/4	850	200-230	56Y	SI202	E56Y22TFC2050	√	\$1,856.00	PM1	82.2 - 81.9	2.4 - 2.2	25	16.02
1	1025								83.1 - 83.0	3.0 - 2.8		
1	1140								84.3 - 84.1	3.0 - 2.8		
3/4	850	460	56Y	SI402	E56Y42TFC2050	√	\$1,856.00	PM1	81.3	1.0	25	16.02
1	1025								83.7	1.3		
1	1140								84.9	1.3		
1	850	200-230	56Y	SI203	E56Y22TFC2051	√	\$2,025.00	PM1	84.6 - 84.3	3 - 2.8	30	16.52
1 1/3	1025								85.5 - 85.3	3.8 - 3.5		
1 1/2	1140								86.2 - 85.8	4.2 - 3.9		
1	850	460	56Y	SI403	E56Y42TFC2051	√	\$2,025.00	PM1	84.7	1.3	30	16.52
1 1/3	1025								87.0	1.6		
1 1/2	1140								87.6	1.9		
2	850	200-230	56Y	SI204	E56Y22TFC2052	√	\$2,137.00	PM1	84.8 - 84.5	5.5 - 5.0	38	17.77
2	1025								86.9 - 86.6	5.4 - 4.9		
2	1140								87.6 - 87.4	5.3 - 4.8		
2	850	460	56Y	SI404	E56Y42TFC2052	√	\$2,137.00	PM1	85.9	2.4	38	17.77
2	1025								87.6	2.3		
2	1140								87.8	2.3		

PERMANENT MAGNET AC

SYMAX® PERMANENT MAGNET AC MOTORS

TENV AND TEFC THREE PHASE MOTORS

FEATURES:

- TENV - Operational to 20:1 constant torque open-loop (1000:1 closed-loop)
- TEFC - Operational to 20:1 constant torque open-loop or closed-loop
- Totally enclosed non-ventilated (TENV), as noted
- High power density, low weight design
- Three year warranty
- Ball bearing
- Requires drive for operation



COMMERCIAL, ROLLED STEEL FRAME (NEMA 56-215 FRAME MODELS)

ADDITIONAL FEATURES:

- Meets or exceeds NEMA Premium® (IE3)
- Class F MAX GUARD® insulation system
- IP43 ingress protection

INDUSTRIAL, CAST IRON FRAME (NEMA 182-286T FRAME MODELS)

ADDITIONAL FEATURES:

- Ultra Efficient Premium-Plus exceeds NEMA Premium (IE4)
- Class H MAX GUARD insulation system
- IP54 ingress protection
- Cast iron construction for rigidity and reduced vibration, as shown
- Premium severe duty
- Normally closed thermostats (one per phase, Class F)
- Provisions for "BCP" (Bearing Current Protection)
- UL, CSA and CE

C-FACE WITH RIGID BASE

HP	RPM	VOLTS	NEMA FRAME	TORQUE (LB-FT)	CAT. NO.	MODEL NO.	STOCK	LIST PRICE	MULT. SYMB.	NOM. EFF.	FL. AMPS	WT.	"C" DIM.	FOOT NOTES
1/2	1800	230/460	56C	1.5	SY001	056PNRA10100	✓	\$755	PM1	82.2	1.9/0.93	15	7.68	N
1	1800	230/460	56C	2.9	SY003	056PNRA10101	✓	\$878	PM1	87.5	3.6/1.8	18	8.68	N
1 1/2	1800	230/460	56C	4.4	SY004	056PNRA10102	✓	\$1,069	PM1	87.5	5.5/2.1	23	9.68	N
2	1800	230/460	56C	5.8	SY005	056PNRA10103	✓	\$1,434	PM1	89.0	6.3/3.2	28	10.68	N
	1200	230/460	56C	8.7	SY035	056PFRA10161	✓	\$2,261	PM1	89.5	5.1/2.6	30	6.18	
3	1800	230/460	182TC	8.8	SY006A	182TPNSB10237	✓	\$2,897	PM1	92.9	6.8/3.4	137	17.50	N
	1800	230/460	182TC	8.8	SY066	182TPFRB10194	✓	\$2,081	PM1	91.4	6.6/3.3	110	16.42	
	1200	230/460	182TC	13.1	SY036	182TPFRB10181	✓	\$4,303	PM1	93.0	7.0/3.5	116	14.97	
5	1800	460	184TC	14.6	SY007	184TPFSA10095	✓	\$2,566	PM1	91.7	6.4	143	16.63	d
	1800	230/460	184TC	14.6	SY007A	184TPNSB10236	✓	\$3,137	PM1	94.9	11.6/5.8	140	17.50	N
	1800	230/460	184TC	14.6	SY067	184TPFRB10214	✓	\$2,310	PM1	93.9	11.7/5.8	130	16.42	
7 1/2	1800	460	213TC	21.9	SY008	213TPFSA10096	✓	\$2,979	PM1	93.0	9.4	152	20.16	d
	1800	230/460	213TC	21.9	SY008A	213TPNSB10234	✓	\$3,583	PM1	94.3	18.2/9.3	190	20.41	N
	1800	230/460	213TC	21.9	SY068	213TPFRB10230	✓	\$2,681	PM1	93.8	17.2/8.6	125	19.47	
10	1800	460	215TC	29.2	SY009	215TPFSA10097	✓	\$3,528	PM1	93.6	11.7	200	20.16	d
	1800	230/460	215TC	29.2	SY009A	215TPNSB10235	✓	\$4,176	PM1	93.9	24.6/12.3	208	20.41	N
	1800	230/460	215TC	29.2	SY069	215TPFRB10219	✓	\$3,242	PM1	94.5	24.7/12.4	139	20.97	
15	1800	460	254TC	43.8	SY010	254TPFSA10088	✓	\$4,273	PM1	94.0	18.0	392	25.68	
20	1800	460	256TC	58.4	SY011	256TPFSA10087	✓	\$4,889	PM1	94.5	24.0	386	25.68	
25	1800	460	284TC	72.9	SY012	284TPFSA10112	✓	\$5,949	PM1	94.5	30.0	408	26.21	
30	1800	460	286TC	87.5	SY013	286TPFSA10090	✓	\$6,751	PM1	95.4	35.5	456	27.71	

Catalog numbers (Cat No.) highlighted in bold blue are premium efficient.

Blue shaded areas are cast iron frames.

NEMA Premium is a trademark of National Electrical Manufacturers Association. All Rights Reserved.

Prices and specifications are subject to change without notice.

DC PERMANENT MAGNET MOTOR

SCR RATED, TOTALLY ENCLOSED

C-FACE FOOTED (REMOVABLE BASE AND NO BASE)

FEATURES:

- Class F insulation (Class H as noted)
- NEMA® C-face with removable rigid base, as noted
- Oversized brushes for extra long life
- Permanently lubricated sealed ball bearings
- Linear speed/torque characteristics over entire speed range
- High starting torque, high peak current capability
- Usable on PWM type DC adjustable speed drives at higher HP rating
- Easy brush access with unique brush holder design
- UL recognized and CSA certified



HP	RPM	DC VOLTS	FRAME	ENCL.	CAT. NO.	MODEL NO.	STOCK	LIST PRICE	MULT. SYMB.	C.T. SPEED RANGE	FL. AMPS	PWM HP RATING	WT.	"C" DIM.	FOOT NOTES
1/4	1750	90	56C	TEFC	Z602	056E17F1001	√	\$794	D1	20:1	2.5	0.4	22	10.81	
	1750	180	56C	TEFC	Z603	056E17F1002	√	\$794	D1	20:1	1.4	0.5	22	11.31	
1/3	1750	90	56C	TEFC	Z604	056E17F1003	√	\$842	D1	20:1	3.5	0.5	24	11.31	
	1750	180	56C	TEFC	Z605	056E17F1004	√	\$842	D1	20:1	1.7	0.5	22	11.31	
1/2	1750	90	56C	TEFC	Z606	056E17F1005	√	\$937	D1	20:1	5.0	0.7	26	11.81	
	1750	180	56C	TEFC	Z607	056E17F1006	√	\$937	D1	20:1	2.5	0.6	25	11.81	
3/4	1750	90	56C	TEFC	Z610	056E17F1007	√	\$1,138	D1	20:1	7.6	1.0	34	13.81	
	1750	180	56C	TEFC	Z611	056E17F1008	√	\$1,138	D1	20:1	3.8	1.0	34	13.81	
1	1750	90	56C	TEFC	Z612	056E17F2005	√	\$1,390	D1	20:1	10.0	1.25	45	14.81	
	1750	180	56C	TEFC	Z613	056E17F2006	√	\$1,390	D1	20:1	5.0	1.25	41	14.81	
1 1/2	1750	180	56C	TEFC	Z614	056E17F2007	√	\$1,737	D1	20:1	7.6	1.75	52	16.81	
	1750	180	145TC	TEFC	Z615	145TEFR5326	√	\$2,639	D1	20:1	7.5	1.5	74	18.34	H
2	1750	180	145TC	TEFC	Z616	145TEFR5327	√	\$3,148	D1	20:1	9.5	2.0	86	19.34	H
	1750	180	182/145TC	TEFC	Z617	182TEFR5326	√	\$3,148	D1	20:1	9.5	2.0	83	19.34	H, 84

CENTURY® DC PERMANENT MAGNET MOTOR

SCR RATED, TOTALLY ENCLOSED

C-FACE FOOTED (REMOVABLE BASE AND NO BASE)

20:1 SPEED RANGE AT CONSTANT TORQUE – 1/8 THRU 3 HP

FEATURES:

- 40°C Ambient
- NEMA® C-Face with removable rigid base (no base as noted)
- UL class H Insulation file #E46316
- CE approved
- UL recognized construction file #55476
- CSA certified file #LR39033
- Continuous duty
- Skewed armature for smooth quiet operation
- No base on DC111, DC112, DC113, DC114, DC116, DC161

If base bolts are removed, bolt holes must be plugged in order to maintain NEMA totally-enclosed standards.

If base bolts are used without base, use a 1/4" thick washer to prevent interference with motor rotation.

HP	RPM	DC VOLTS	FRAME	ENCL.	CAT. NO.	MODEL NO.	STOCK	LIST PRICE	MULT. SYMB.	FL. AMPS	INSUL. CLASS	BASE / MOUNTING	"C" DIM.
90 Volt Armature • Permanent Magnet Field													
1/8	1750	90	48C	TENV	DC106	Century	√	\$729	D1	1.4	H	Removable Rigid	8.12
	1750	90	56C	TENV	DC109	Century	√	\$717	D1	1.4	H	No Base	8.43
	1750	90	56C	TENV	DC117	Century	√	\$729	D1	1.4	H	Removable Rigid	8.43
1/6	1750	90	42CZ	TENV	DC104	Century	√	\$787	D1	1.7	H	No Base	8.31
	1750	90	48C	TEFC	DC107	Century	√	\$778	D1	1.9	H	Removable Rigid	9.33
1/4	1750	90	42CZ	TEFC	DC105	Century	√	\$851	D1	2.7	H	No Base	10.02
	1750	90	48C	TEFC	DC108	Century	√	\$866	D1	2.7	H	Removable Rigid	10.33
	1750	90	56C	TEFC	DC110	Century	√	\$875	D1	2.7	H	No Base	10.65
	1750	90	56C	TEFC	DC118	Century	√	\$899	D1	2.7	H	Removable Rigid	10.65
	1750	90	56C	TENV	DC111	Century	√	\$951	D1	2.7	H	No Base	9.71
	1750	90	56C	TENV	DC119	Century	√	\$981	D1	2.7	H	Removable Rigid	9.71
1/3	1750	90	56C	TENV	DC112	Century	√	\$1,006	D1	3.7	H	No Base	10.21
	1725	90	56C	TENV	DC120	Century	√	\$1,036	D1	3.7	H	Removable Rigid	10.21
1/2	2500	90	56C	TENV	DC133	Century	√	\$1,036	D1	5.0	H	No Base	11.71
	1750	90	56C	TEFC	DC113	Century	√	\$1,048	D1	5.0	H	No Base	11.81
	1750	90	56C	TEFC	DC121	Century	√	\$1,390	D1	5.0	H	Removable Rigid	11.81
	1750	90	56C	TENV	DC114	Century	√	\$1,133	D1	5.0	H	No Base	11.71
	1750	90	56C	TENV	DC122	Century	√	\$1,161	D1	5.0	H	Removable Rigid	11.71
	2500	90	56C	TEFC	DC129	Century	√	\$1,200	D1	7.6	H	Removable Rigid	11.81
	1750	90	56C	TEFC	DC115	Century	√	\$1,373	D1	7.6	H	No Base	13.81
	1750	90	56C	TEFC	DC123	Century	√	\$1,404	D1	7.6	H	Removable Rigid	13.81
1	2500	90	56C	TEFC	DC165	Century	√	\$1,404	D1	10.0	H	No Base	13.32
	1750	90	56C	TEFC	DC116	Century	√	\$1,651	D1	10.0	H	No Base	14.82
	1750	90	56C	TEFC	DC124	Century	√	\$1,680	D1	10.0	H	Removable Rigid	14.82
180 Volt Armature • Permanent Magnet Field													
1/3	1750	180	56C	TENV	DC145	Century	√	\$1,006	D1	1.8	H	No Base	10.71
1/2	2500	180	56C	TENV	DC126	Century	√	\$1,006	D1	2.8	H	No Base	11.71
	1750	180	56C	TEFC	DC125	Century	√	\$1,048	D1	2.5	H	No Base	11.81
3/4	1750	180	56C	TEFC	DC130	Century	√	\$1,079	D1	2.5	H	Removable Rigid	11.81
	1750	180	56C	TENV	DC134	Century	√	\$1,133	D1	2.8	H	No Base	11.71
	1750	180	56C	TEFC	DC127	Century	√	\$1,373	D1	3.8	H	No Base	13.81
1	1750	180	56C	TEFC	DC131	Century	√	\$1,404	D1	3.8	H	Removable Rigid	13.81
	2500	180	56C	TEFC	DC162	Century	√	\$1,404	D1	5.0	H	Removable Rigid	13.82
1 1/2	1750	180	56C	TEFC	DC128	Century	√	\$1,653	D1	5.0	H	No Base	14.82
	1750	180	56C	TEFC	DC132	Century	√	\$1,680	D1	5.0	H	Removable Rigid	14.82
2	2500	180	143/145TC	TEFC	DC163	Century	√	\$3,023	D1	8.7	H	Removable Rigid	16.34
	1750	180	143/145TC	TEFC	DC135	Century	√	\$3,035	D1	7.5	H	No Base	18.34
	1750	180	143/145TC	TEFC	DC142	Century	√	\$3,126	D1	7.5	H	Removable Rigid	18.34
3	2500	180	143/145TC	TEFC	DC164	Century	√	\$3,126	D1	10.5	H	Removable Rigid	17.34
	1750	180	143/145TC	TEFC	DC136	Century	√	\$3,728	D1	9.5	H	No Base	19.34
	1750	180	143/145TC	TEFC	DC166	Century	√	\$3,819	D1	9.5	H	Removable Rigid	19.34
3	1750	180	143/145TCY	TEFC	DC158	Century	√	\$3,883	D1	9.5	H	Removable Rigid	19.34
	1750	180	143/145TC	TEFC	DC161	Century	√	\$4,564	D1	15.0	H	No Base	22.34
	1750	180	143/145TC	TEFC	DC144	Century	√	\$4,649	D1	15.0	H	Removable Rigid	22.34

NEMA is a trademark of National Electrical Manufacturers Association. All Rights Reserved.

Prices and specifications are subject to change without notice.

WASH DOWN DUTY® DC PERMANENT MAGNET MOTOR

SCR RATED, TOTALLY ENCLOSED
C-FACE FOOTED (REMOVABLE BASE)

FEATURES:

- Class F insulation
- NEMA® C-face with removable rigid base
- Oversized brushes for extra long life
- Double sealed, oversized ball bearings
- Corrosion resistant 303 stainless steel shaft
- "V" ring Forsheda® seals
- High temperature, moisture resistant lubricant
- Exterior and interior components protected with enamel & polyester compounds
- Aluminum conduit box, threaded and gasketed
- Drains at 3:00, 6:00, 9:00 and 12:00 locations
- Sealed machine fits
- Stainless steel nameplate
- USDA approved white epoxy paint
- UL recognized and CSA certified



HP	RPM	DC VOLTS	FRAME	ENCL.	CAT. NO.	MODEL NO.	STOCK	LIST PRICE	MULT. SYMB.	C.T. SPEED RANGE	FL. AMPS	PWM HP RATING	WT.	"C" DIM.	FOOT NOTES
1/4	1750	90	56C	TENV	Z630	056E17V2001	√	\$1,018	D1	20:1	2.7	0.30	24	10.69	
1/3	1750	90	56C	TENV	Z631	056E17V2002		\$1,077	D1	20:1	3.5	0.56	30	11.69	
1/2	1750	90	56C	TENV	Z634	056E17V2003	√	\$1,206	D1	20:1	4.9	0.75	37	13.69	
	1750	180	56C	TENV	Z635	056E17V2004	√	\$1,206	D1	20:1	2.4	0.70	41	13.69	
3/4	1750	90	56C	TENV	Z636	056E17V2005	√	\$1,463	D1	20:1	7.0	1.25	51	14.67	
	1750	180	56C	TENV	Z637	056E17V2006	√	\$1,463	D1	20:1	3.5	1.25	50	14.17	
1	1750	90	56C	TEFC	Z638	056E17W2001	√	\$1,785	D1	2:1	10.0	1.25	45	14.81	
	1750	180	56C	TEFC	Z639	056E17W2002	√	\$1,785	D1	2:1	5.0	1.25	41	14.81	
1 1/2	1750	180	56C	TEFC	Z641	056E17W2003		\$2,279	D1	2:1	7.6	1.75	51	16.81	

CENTURY® INDUSTRIAL PMDC WASHDOWN MOTORS

PMDC WASHDOWN MOTOR – 90 AND 180 VOLTS – 1725 RPM – TEFC – 1/4 THRU 1 HP REMOVABLE RIGID BASE

FEATURES:

- Double sealed ball bearings
- USDA approved epoxy primer and paint
- Stainless steel shaft and drain plugs
- Treated interior surfaces
- Continuous duty
- SCR rated
- Skewed armature for smooth, quiet operation
- Shaft seals
- Gasketed construction
- 40°C ambient
- UL/CSA/CE approved

HP	RPM	DC VOLTS	FRAME	ENCL.	CAT. NO.	MODEL NO.	STOCK	LIST PRICE	MULT. SYMB.	FL. AMPS	NSUL. CLASS	WT.	"C" DIM.	FOOT NOTES
1/4	1750	90	56C	TEFC	DC148	Century	√	\$1,170	D1	2.5	H	21	10.81	
1/3	1750	90	56C	TEFC	DC149	Century	√	\$1,297	D1	3.5	H	23	11.31	
1/2	1750	90	56C	TEFC	DC150	Century	√	\$1,413	D1	5.0	H	26	11.81	
	1750	180	56C	TEFC	DC151	Century	√	\$1,413	D1	2.5	H	26	11.81	
3/4	1750	90	56C	TEFC	DC152	Century	√	\$1,714	D1	7.6	H	33	13.81	
	1750	180	56C	TEFC	DC153	Century	√	\$1,714	D1	3.8	H	33	13.81	
1	1750	90	56C	TEFC	DC154	Century	√	\$1,984	D1	10.0	H	40	14.81	
	1750	180	56C	TEFC	DC155	Century	√	\$1,984	D1	5.0	H	41	14.81	

Forsheda is believed to be the trademark or trade name of Trelleborg Forsheda Sweden AB and is not owned or controlled by Regal Beloit Corporation.
NEMA is a trademark of National Electrical Manufacturers Association.
All Rights Reserved.

LOW VOLTAGE, DC PERMANENT MAGNET MOTOR TENV AND TEFC

C-FACE FOOTED (REMOVABLE BASE)

APPLICATIONS:

Low voltage permanent magnet DC motors are suitable for installations having batteries or generator supplied low voltage DC.

FEATURES:

- Permanently lubricated sealed ball bearings
- NEMA® C-face with removable base
- Class H insulation
- Easy brush access with unique brush holder design
- Oversized brushes for extra long life
- High starting torque
- U.L. recognized and CSA certified



HP	RPM	DC VOLTS	FRAME	ENCL.	CAT. NO.	MODEL NO.	STOCK	LIST PRICE	MULT. SYMB.	FL. AMPS	WT.	"C" DIM.	FOOT NOTES
1/4	1750	12	56C	TENV	Z660	056E17T2001	√	\$853	D1	21.0	22	10.27	85
1/3	1750	12	56C	TENV	Z662	056E17T2002	√	\$939	D1	27.0	24	10.77	85
	1750	24	56C	TENV	Z663	056E17T2003	√	\$897	D1	13.5	23	10.77	85
1/2	1750	12	56C	TENV	Z664	056E17T2004	√	\$975	D1	39.0	30	11.77	85
	1750	24	56C	TENV	Z665	056E17T2005	√	\$932	D1	20.0	28	11.77	d, 85
3/4	1750	12	56C	TEFC	Z666	056E17F2008	√	\$1,077	D1	58.0	35	13.81	85
	1750	24	56C	TEFC	Z667	056E17F2009	√	\$974	D1	29.0	32	12.81	85
1	1750	12	56C	TEFC	Z668	056E17F2010	√	\$1,283	D1	80.0	39	13.81	85
	1750	24	56C	TEFC	Z669	056E17F2011	√	\$1,183	D1	39.0	34	13.81	85
1 1/2	1750	24	56CZ	TEFC	Z670	056E17F2014	√	\$1,430	D1	60.0	53	17.38	85
2	1750	24	56CZ	TEFC	Z671	056E17F2015	√	\$1,731	D1	70.0	68	16.74	85



SCR PMDC MOTORS ON PWM POWER SUPPLIES

Pulse width modulated DC controls have a voltage output similar to pure direct current which has a form factor of 1.05. SCR thyristor drives have a form factor of 1.40. Marathon® Non-Explosion Proof PMDC, SCR-rated motors can also be used with PWM controls, and due to the lower form factor and the resultant lower heating in the motor, their rating can be increased as indicated above. Operation on PWM controls will also result in quieter operation and longer brush life.

GLOBETROTTER® IEC (METRIC) FRAME, THREE PHASE MOTORS

TOTALLY ENCLOSED, B3 MOUNTING, RIGID BASE MOTORS

APPLICATIONS:

For use on fans, pumps, compressors, conveyors, and other equipment requiring IEC dimensions and electrical standards. The Globetrotter motor is not only designed to International standards but meets NEMA® performance and efficiency standards making it suitable for requirements worldwide.



CONSULT REGAL FOR SPECIAL IEC MOTORS

FEATURES:

- Meets IE3 European and NEMA premium efficiency standards
- Aluminum (63-90 frame) or cast iron (100-315 frame) frame construction
- Nameplated 60/50 hertz at same HP, above 90 frame is 60/50 Hz at next lower HP
- MAX GUARD® Class F insulation, class B rise @ rated KW
- IP55 weatherproof enclosure
- Rotatable/removable base (63-90 frame)
- Wye Start-Delta Run on 160 frame and larger
- 10:1 variable torque, constant torque speed range as noted
- Top mounted/oversized gasketed terminal box
- Meets IEEE45, IEC60092 & USCG CFR46 Marine Duty (63-90 frame "below deck")
- 1.15 service factor on 60 Hz sine wave, 1.0 SF or VFD
- IEC design "N" with NEMA "B" torques
- Terminal blocks, stud type, zero creepage
- Kits or MOD central for B3/B14 mounting, see accessories section
- Meets IEC 34 electrical standards
- Meets IEC 72 dimensions and tolerances
- CE marked
- 1 year warranty

MULTIPLIER SYMBOL F4

HP/KW	RPM 60/50 HZ	60 HZ VOLTS	50 HZ VOLTS	IEC FRAME	CAT. NO.	MODEL NO.	STOCK	CT SPEED RANGE*	LIST PRICE	NOM. EFF.	60 HZ FL. AMPS	WT.	IEC "L" DIM. (MM)	FOOT NOTES	B5/FF FLANGE
1/4-19	3600/3000	230/460	200/400	63	R300	063T34FH5301	✓	20:1	\$298	72.0	0.8/0.4	11	217		A569
	3600/3000	575	480	63	R400	063T34FH5303	✓	20:1	\$298	72.0	0.3	11	217		A569
	1800/1500	230/460	200/400	63	R301	063T17FH5326	✓	20:1	\$311	68.0	1.0/0.5	12	217		A569
	1800/1500	575	480	63	R401	063T17FH5327	✓	20:1	\$311	68.0	0.4	12	217		A569
	1200/1000	230/460	200/400	71	R302	071T11FH5376	✓	20:1	\$529	64.0	1.2/0.6	13	240		A570
1/3-25	3600/3000	230/460	200/400	63	R303	063T34FH5302	✓	20:1	\$349	72.0	1.1/55	12	217		A569
	3600/3000	575	480	63	R403	063T34FH5304	✓	20:1	\$349	72.0	0.4	12	217		A569
	1800/1500	230/460	200/400	71	R304	071T17FH5326	✓	20:1	\$363	68.0	1.4/7	14	240		A570
	1800/1500	575	480	71	R404	071T17FH5330	✓	20:1	\$363	68.0	0.6	14	240		A570
	1200/1000	230/460	200/400	80	R305	080T11FH5376	✓	20:1	\$569	70.0	1.3/65	20	282		A571
1/2-37	3600/3000	230/460	200/400	71	R306	071T34FH5301	✓	20:1	\$371	74.0	1.6/8	15	240		A570
	3600/3000	575	480	71	R406	071T34FH5303	✓	20:1	\$371	74.0	0.7	14	240		A570
	1800/1500	230/460	200/400	71	R307	071T17FH5327	✓	20:1	\$378	74.0	1.8/9	15	240		A570
	1800/1500	575	480	71	R407	071T17FH5331	✓	20:1	\$378	74.0	0.7	16	240		A570
	1200/1000	230/460	200/400	80	R308	080T11FH5377	✓	20:1	\$593	72.0	1.9/95	22	282		A571
3/4-56	3600/3000	230/460	200/400	71	R309	071T34FH5302	✓	20:1	\$390	74.0	2.4/1.2	17	240		A570
	3600/3000	575	480	71	R409	071T34FH5304	✓	20:1	\$390	74.0	0.9	17	240		A570
	1800/1500	230/460	200/400	80	R310	080T17FH5326	✓	20:1	\$411	74.0	2.5/1.25	23	282		A571
	1800/1500	575	480	80	R410	080T17FH5330	✓	20:1	\$411	74.0	1.0	22	282		A571
	1200/1000	230/460	200/400	80	R311	080T11FH5378	✓	20:1	\$638	72.0	2.7/1.35	25	282		A571
1-75	3600/3000	230/460	200/400	80	R312	080T34FH5301	✓	20:1	\$477	75.5	2.8/1.4	24	282	d	A571
	3600/3000	230/460	200/400	80	R312A	080T34FH15301	✓	20:1	\$443	77.0	2.8/1.4	31	282		A571
	3600/3000	575	480	80	R412	080T34FH5305	✓	20:1	\$443	75.5	1.1	24	282	d	A571
	3600/3000	575	480	80	R412A	080T34FH15305	✓	20:1	\$477	77.0	1.2	31	282		A571
	1800/1500	230/460	200/400	80	R313A	080T17FH15327	✓	20:1	\$502	85.5	3.0/1.5	34	302		A571
	1800/1500	575	480	80	R413	080T17FH5331	✓	20:1	\$449	80.0	1.4	28	282	d	A571
	1800/1500	575	480	80	R413A	080T17FH15331	✓	20:1	\$502	85.5	1.2	34	302		A571
	1200/1000	230/460	200/400	90S	R314A	090ST11FH6376	✓	20:1	\$775	82.5	3.3/1.7	39	326		A572
1 1/2-1.1	3600/3000	230/460	200/400	80	R315	080T34FH5302	✓	20:1	\$457	84.0	4.0/2.0	30	282		A571
	3600/3000	575	480	80	R415	080T34FH5303	✓	20:1	\$457	84.0	1.6	29	282		A571
	1800/1500	230/460	200/400	90S	R316A	090ST17FH6326	✓	20:1	\$588	88.5	4.2/2.1	40	326		A572
	1800/1500	575	480	90S	R416A	090ST17FH6327	✓	20:1	\$588	86.5	1.8	39	326		A572
1200/1000	230/460	200/400	100L	R317	100LTF6586	✓	2:1	\$918	87.5	4.6/2.3	90	380		A554A	

Catalog numbers (Cat No.) highlighted in bold blue are premium efficient. Blue shaded areas are cast iron frames.

* Requires nameplate modification

Continued on next page.

GLOBETROTTER® IEC (METRIC) FRAME, THREE PHASE MOTORS

TOTALLY ENCLOSED, B3 MOUNTING, RIGID BASE MOTORS

IEC MOTORS

HP/KW	RPM 60/50 HZ	60 HZ VOLTS	50 HZ VOLTS	IEC FRAME	CAT. NO.	MODEL NO.	STOCK	CT SPEED RANGE*	LIST PRICE	NOM. EFF.	60 HZ FL. AMPS	WT.	IEC "L" DIM. (MM)	FOOT NOTES	B5/FF FLANGE
2-1.5	3600/3000	230/460	200/400	90S	R318A	090ST34FH6301	√	20:1	\$612	85.5	5.0/2.5	37	326		A572
	3600/3000	575	480	90S	R418A	090ST34FH6302	√	20:1	\$612	85.5	2.1	37	326		A572
	1800/1500	230/460	200/400	90L	R319A	090LT17FH6326	√	20:1	\$631	87.5	5.4/2.7	44	341		A572
	1800/1500	575	480	90L	R419A	090LT17FH6327	√	20:1	\$631	87.5	2.3	44	341		A572
	1200/1000	230/460	200/400	100L	R320A	100LTFC6576	√	2:1	\$987	88.5	6.0/3.0	99	415		A554A
	1200/1000	575	480	100L	R420A	100LTFC6577	√	2:1	\$987	87.5	1.9	98	415		A554A
3-2.2	3600/3000	230/460	200/400	90L	R321A	090LT34FH6301	√	20:1	\$881	87.5	7.2/3.6	42	341		A572
	3600/3000	575	480	90L	R421A	090LT34FH6302	√	20:1	\$881	87.5	3.0	42	341		A572
	1800/1500	230/460	200/400	100L	R322A	100LTFC6526	√	20:1	\$956	90.2	8.0/4.0	107	415		A554A
	1800/1500	575	480	100L	R422A	100LTFC6527	√	20:1	\$956	90.2	3.2	105	415		A554A
	1200/1000	230/460	200/400	112M	R323A	112MTFC6576	√	20:1	\$1,393	89.5	9.6/4.8	146	468		A554A
	3600/3000	230/460	200/400	100L	R351A	100LTFC6501	√	20:1	\$1,020	89.5	9.2/4.6	96	415		A554A
4-3	3600/3000	575	480	100L	R451A	100LTFC6502	√	20:1	\$1,020	89.5	3.7	96	415		A554A
	1800/1500	230/460	200/400	100L	R352A	100LTFC6536	√	20:1	\$1,038	89.5	10.0/5.0	105	415		A554A
	1800/1500	575	480	100L	R452A	100LTFC6537	√	20:1	\$1,038	89.5	4.4	105	415		A554A
	1200/1000	230/460	200/400	132S	R353A	132STFC6586	√	2:1	\$1,686	89.5	12.4/6.2	175	464		A556A
5 1/2-4.1	3600/3000	230/460	200/400	112M	R324A	112MTFC6511	√	20:1	\$1,313	89.5	12.6/6.3	123	410		A555B
	3600/3000	575	480	112M	R424A	112MTFC6512	√	20:1	\$1,313	89.5	5.1	122	410		A555B
	1800/1500	230/460	200/400	112M	R325A	112MTFC6536	√	20:1	\$1,265	89.5	14.0/7.0	122	410		A555B
	1800/1500	575	480	112M	R425A	112MTFC6537	√	20:1	\$1,265	91.7	9.6	122	410		A555B
	1200/1000	230/460	200/400	132M	R326A	132MTFC6586	√	2:1	\$1,946	89.5	17/8.5	258	502		A556A
	3600/3000	230/460	200/400	132S	R327A	132STFC6501	√	20:1	\$1,646	89.5	17.6/8.8	275	464		A550
7 1/2-5.5	3600/3000	575	480	132S	R427A	132STFC6503	√	20:1	\$1,646	91.0	7.0	171	464		A550
	1800/1500	230/460	200/400	132S	R328A	132STFC6526	√	20:1	\$1,591	92.4	18.4/9.2	178	464		A556A
	1800/1500	575	480	132S	R428A	132STFC6527	√	20:1	\$1,591	91.7	7.8	178	464		A556A
	1200/1000	230/460	200/400	132M	R329A	132MTFC6587	√	2:1	\$2,341	91.0	21.6/10.8	230	502		A556A
10-7.5	3600/3000	230/460	200/400	132S	R330A	132STFC6502	√	20:1	\$1,761	90.2	24.0/12.0	192	464		A550
	3600/3000	575	480	132S	R430A	132STFC6504	√	20:1	\$1,761	91.0	9.6	200	464		A550
	1800/1500	230/460	200/400	132M	R331A	132MTFC6536	√	2:1	\$1,952	91.7	24.0/12.0	199	502		A556A
	1800/1500	575	480	132M	R431A	132MTFC6537	√	2:1	\$1,952	91.7	9.6	192	502		A556A
	1200/1000	230/460	200/400	160M	R332A	160MTFC6586	√	2:1	\$3,036	92.1	28.8/14.4	295	615	YD	A557
	3600/3000	230/460	200/400	160M	R333A	160MTFC6511	√	2:1	\$2,853	91.0	35.0/17.5	260	600	YD	A551
15-11	1800/1500	230/460	200/400	160M	R334A	160MTFC6536	√	10:1	\$2,799	92.4	37.0/18.5	291	600	YD	A557
	1200/1000	230/460	200/400	160L	R335A	160LTFC6588	√	2:1	\$3,897	91.7	40.0/20.0	362	675	YD	A557
20-15	3600/3000	230/460	200/400	160M	R336A	160MTFC6512	√	10:1	\$3,347	91.7	47.0/23.5	301	600	YD	A551
	1800/1500	230/460	200/400	160L	R337A	160LTFC6538	√	2:1	\$3,529	93.0	49.0/24.6	354	600	YD	A557
	1200/1000	230/460	200/400	180L	R338A	180LTFC6588	√	2:1	\$5,465	92.4	54.0/27.0	385	718	YD	A558
	3600/3000	230/460	200/400	160L	R339A	160LTFC6513	√	2:1	\$4,074	91.7	58.0/29.0	329	645	YD	A551
25-18.5	1800/1500	230/460	200/400	180M	R340A	180MTFC6536	√	20:1	\$4,485	93.6	59.2/29.6	454	680	YD	A558
	1200/1000	230/460	200/400	200L	R341A	200LTFC6588	√	2:1	\$6,853	93.0	63.0/31.5	622	775	YD	A559
30-22	3600/3000	230/460	200/400	180M	R342A	180MTFC6511	√	2:1	\$4,842	93.0	69.0/34.5	432	680	YD	A552
	1800/1500	230/460	200/400	180L	R343A	180LTFC6538	√	20:1	\$5,041	94.1	70.0/35.0	497	718	YD	A558
	1200/1000	230/460	200/400	200L	R344A	200LTFC6589	√	2:1	\$7,763	93.6	77.0/38.5	668	750	YD	A559
40-30	3600/3000	230/460	200/400	200L	R345A	200LTFC6511	√	20:1	\$6,893	93.0	91.0/45.5	595	750	YD	A553
	1800/1500	230/460	200/400	200L	R346A	200LTFC6538	√	2:1	\$7,421	94.1	92.0/46.0	607	750	YD	A559
	1200/1000	230/460	200/400	225M	R347A	225MTFC6586	√	2:1	\$11,665	94.1	100.0/50.0	847	837	YD	A580
50-37	3600/3000	230/460	200/400	200L	R348A	200LTFC6513	√	10:1	\$9,041	94.1	112.0/56.0	655	750	YD	A553
	1800/1500	230/460	200/400	225S	R349A	225STFC6526	√	10:1	\$10,296	94.5	118.0/59.0	782	812	YD	A580
	1200/1000	230/460	200/400	250M	R350A	250MTFC6586	√	2:1	\$16,350	94.1	120.0/60.0	1073	1350	YD	A594
60-45	3600/3000	230/460	200/400	225M	R500	225MTFC6501	√	10:1	\$14,015	94.1	134.0/67.0	833	837	YD	A580
	1800/1500	230/460	200/400	225M	R501	225MTFC6526	√	10:1	\$15,472	95.0	138.0/69.0	847	837	YD	A580
	1200/1000	230/460	200/400	280S	R502	280STFC6586	√	2:1	\$20,645	95.0	152.0/76.0	1303	975	YD	A596
75-55	3600/3000	230/460	200/400	250M	R503	250MTFC6501	√	10:1	\$19,235	93.6	166.0/83.0	1064	1350	YD	A594
	1800/1500	230/460	200/400	250M	R504	250MTFC6526	√	10:1	\$18,107	95.4	174.0/87.0	1157	922	YD	A594
	1200/1000	230/460	200/400	280M	R505	280MTFC6588	√	2:1	\$22,756	94.5	190.0/95.0	1445	1026	YD	A596
100-75	3600/3000	230/460	200/400	280S	R506	280STFC6501	√	10:1	\$23,006	94.1	222.0/111.0	1349	975	YD	A596
	1800/1500	230/460	200/400	280S	R507	280STFC6526	√	10:1	\$20,907	95.4	226.0/113.0	1435	975	YD	A596
	1200/1000	230/460	200/400	315S	R508	315STFC6588	√	2:1	\$28,499	95.0	226.0/113.0	2200	1240	YD	A598

Catalog numbers (Cat No.) highlighted in bold blue are premium efficient. Blue shaded areas are cast iron frames.

* Requires nameplate modification

Continued on next page.

GLOBETROTTER® IEC (METRIC) FRAME, THREE PHASE MOTORS

TOTALLY ENCLOSED, B3 MOUNTING, RIGID BASE MOTORS



B3/B5 "F" (D-FLANGE)

HP/KW	RPM 60/50 HZ	60 HZ VOLTS	50 HZ VOLTS	IEC FRAME	CAT. NO.	MODEL NO.	STOCK	CT SPEED RANGE*	LIST PRICE	NOM. EFF.	60 HZ FL. AMPS	WT.	IEC "L" DIM. (MM)	FOOT NOTES	B5/FF FLANGE
1/4-19	3600/3000	230/460	200/400	63D	R380	063T34FH5501	√	20:1	\$343	72.0	0.8/0.4	10	217		
	1800/1500	230/460	200/400	63D	R381	063T17FH5502	√	20:1	\$354	68.0	1.0/0.5	11	217		
	1200/1000	230/460	200/400	71D	R382	071T11FH5503	√	20:1	\$609	64.0	1.2/0.6	12	240		
1/3-25	3600/3000	230/460	200/400	63D	R383	063T34FH5504	√	20:1	\$397	72.0	1.1/1.55	11	217		
	1800/1500	230/460	200/400	71D	R384	071T17FH5505	√	20:1	\$410	68.0	1.4/1.7	13	240		
	1200/1000	230/460	200/400	80D	R385	080T11FH5506	√	20:1	\$653	70.0	1.3/1.65	17	282		
1/2-37	3600/3000	230/460	200/400	71D	R386	071T34FH5507	√	20:1	\$406	74.0	1.6/1.8	15	240		
	1800/1500	230/460	200/400	71D	R387	071T17FH5508	√	20:1	\$421	74.0	1.8/1.9	17	282		
	1200/1000	230/460	200/400	80D	R388	080T11FH5509	√	20:1	\$681	72.0	1.9/1.95	21	282		
3/4-56	3600/3000	230/460	200/400	71D	R389	071T34FH5510	√	20:1	\$430	74.0	2.4/1.2	17	282		
	1800/1500	230/460	200/400	80D	R390	080T17FH5511	√	20:1	\$459	74.0	2.5/1.25	23	282		
	1200/1000	230/460	200/400	80D	R391	080T11FH5512	√	20:1	\$720	72.0	2.7/1.35	22	282		
1-75	3600/3000	230/460	200/400	80D	R392	080T34FH5513	√	20:1	\$473	75.5	2.8/1.4	21	282	d	
	3600/3000	230/460	200/400	80D	R392A	080T34FH15513	√	20:1	\$524	77.0	2.8/1.4	23	282		
	1800/1500	230/460	200/400	80D	R393A	080T17FH15514	√	20:1	\$548	85.5	3.0/1.5	26	302		
	1200/1000	230/460	200/400	90SD	R394A	090ST11FH6515	√	20:1	\$886	82.5	3.2/1.6	35	326		
1 1/2-1.1	3600/3000	230/460	200/400	80D	R395	080T34FH5516	√	20:1	\$540	84.0	4.0/2.0	30	282		
	1800/1500	230/460	200/400	90SD	R396A	090ST17FH6517	√	20:1	\$642	88.5	4.2/2.1	37	326		
2-1.5	3600/3000	230/460	200/400	90SD	R397A	090ST34FH6518	√	20:1	\$700	85.5	5.0/2.5	38	326		
	1800/1500	230/460	200/400	90LD	R398A	090LT17FH6519	√	20:1	\$719	87.5	5.4/2.7	45	326		
3-2.2	3600/3000	230/460	200/400	90LD	R399A	090LT34FH6520	√	20:1	\$990	87.5	7.2/3.6	42	326		

Catalog numbers (Cat No.) highlighted in bold blue are premium efficient



B3/B14 "FT" (C-FACE)

HP/KW	RPM 60/50 HZ	60 HZ VOLTS	50 HZ VOLTS	IEC FRAME	CAT. NO.	MODEL NO.	STOCK	CT SPEED RANGE*	LIST PRICE	NOM. EFF.	60 HZ FL. AMPS	WT.	IEC "L" DIM. (MM)	FOOT NOTES	B5/FF FLANGE
1/4-19	3600/3000	230/460	200/400	63C	R360	063T34FH5401	√	20:1	\$336	72.0	0.8/0.4	10	217		
	1800/1500	230/460	200/400	63C	R361	063T17FH5402	√	20:1	\$349	68.0	1.0/0.5	11	217		
	1200/1000	230/460	200/400	71C	R362	071T11FH5403	√	20:1	\$609	64.0	1.2/0.6	12	240		
1/3-25	3600/3000	230/460	200/400	63C	R363	063T34FH5404	√	20:1	\$394	72.0	1.1/1.55	12	217		
	1800/1500	230/460	200/400	71C	R364	071T17FH5405	√	20:1	\$398	68.0	1.4/1.7	13	240		
	1200/1000	230/460	200/400	80C	R365	080T11FH5406	√	20:1	\$653	70.0	1.3/1.65	17	282		
1/2-37	3600/3000	230/460	200/400	71C	R366	071T34FH5407	√	20:1	\$400	74.0	1.6/1.8	17	240		
	1800/1500	230/460	200/400	71C	R367	071T17FH5408	√	20:1	\$416	74.0	1.8/1.9	16	240		
	1200/1000	230/460	200/400	80C	R368	080T11FH5409	√	20:1	\$681	72.0	1.9/1.95	19	282		
3/4-56	3600/3000	230/460	200/400	71C	R369	071T34FH5410	√	20:1	\$421	74.0	2.4/1.2	16	282		
	1800/1500	230/460	200/400	80C	R370	080T17FH5411	√	20:1	\$451	74.0	2.5/1.25	23	282		
	1200/1000	230/460	200/400	80C	R371	080T11FH5412	√	20:1	\$720	72.0	2.7/1.35	25	282		
1-75	3600/3000	230/460	200/400	80C	R372	080T34FH5413	√	20:1	\$464	75.5	2.8/1.4	21	282	d	
	3600/3000	230/460	200/400	80C	R372A	080T34FH15413	√	20:1	\$512	77.0	2.8/1.4	23	282		
	1800/1500	230/460	200/400	80C	R373	080T17FH5414	√	20:1	\$485	80.0	3.2/1.6	28	282	d	
	1800/1500	230/460	200/400	80C	R373A	080T17FH15414	√	20:1	\$536	85.5	3.0/1.5	30	302		
1 1/2-1.1	3600/3000	230/460	200/400	90SC	R374A	090ST11FH6415	√	20:1	\$886	82.5	3.2/1.6	35	326		
	1800/1500	230/460	200/400	90SC	R375	080T34FH5416	√	20:1	\$528	84.0	4.0/2.0	28	282		
2-1.5	3600/3000	230/460	200/400	90SC	R376A	090ST17FH6417	√	20:1	\$630	86.5	4.2/2.1	37	326		
	1800/1500	230/460	200/400	90SC	R377A	090ST34FH6418	√	20:1	\$685	85.5	5.0/2.5	38	326		
3-2.2	3600/3000	230/460	200/400	90LC	R378A	090LT17FH6419	√	20:1	\$700	87.5	5.4/2.7	44	326		
	3600/3000	230/460	200/400	90LC	R379A	090LT34FH6420	√	20:1	\$990	87.5	7.2/3.6	41	326		

Catalog numbers (Cat No.) highlighted in bold blue are premium efficient.

* Requires nameplate modification

BRAKE MOTORS, SINGLE PHASE

TOTALLY ENCLOSED, C-FACE FOOTED (REMOVABLE BASE)

FEATURES:

- Fail-safe, spring set Stearns® 56,000 series brake for holding or stopping
- Brake has manual wear adjustment for longer pad life
- Manual release lever on rear of brake housing
- Brake leads are terminated at the brake
- Universal mounting, no modifications needed
- Brake coil voltage matches motor voltages, see mod section for other brake coils
- Ball bearings, mechanically locked on shaft end
- 1.15 service factor (1.0 service factor as noted)
- Nameplated 60/50 hertz at next lowest horsepower
- UL recognized and CSA certified



HP	RPM	VOLTS	FRAME	CAT. NO.	MODEL NO.	STOCK	LIST PRICE	MULT. SYMB.	F.L. AMPS	WT.	"C" DIM.	BRAKE RATING (LB/FT)	FOOT NOTES
1/3	1800	115/208-230	56C	D400	056C17F5352	√	\$1,022	E5	6.6/3.1-3.3	33	16.20	3	2, 6
1/2	1800	115/208-230	56C	D401	056C17F5353	√	\$1,127	E5	8.8/4.2-4.4	34	16.20	3	2, 6
3/4	1800	115/208-230	56C	D402	056C17F5354	√	\$1,460	E5	11.0/5.4-5.5	38	16.70	6	2, 6
1	1800	115/208-230	56C	D403	056C17F5355	√	\$1,552	E5	13.4/6.8-6.7	40	17.20	6	2, 6
1 1/2	1800	115/208-230	56C	D404	056B17F5330	√	\$1,638	E5	15.2/8.2-7.6	50	19.04	10	1, 6

BRAKE MOTORS

Stearns is believed to be a trademark or trade name of Rexnord Corporation and is not owned or controlled by Regal Beloit Corporation.

Prices and specifications are subject to change without notice.

BRAKE MOTORS, THREE PHASE

TOTALLY ENCLOSED

FEATURES

In addition to the single phase features on page 107:

- Meets or exceeds NEMA Premium® efficiencies. NEMA Premium models are in compliance with EISA 2007
- Brake has manual wear adjustment for longer pad life
- Brake leads routed through motor conduit box (TENV only)
- Universal mounting, no modifications needed
- CR²⁰⁰ corona resistant magnet wire (motor can be operated 10:1 variable torque)



RIGID BASE

HP	RPM	VOLTS	FRAME	CAT. NO.	MODEL NO.	STOCK	LIST PRICE	MULT. SYMB.	FL. AMPS	WT.	"C" DIM.	BRAKE RATING (LB/FT)	FOOT NOTES
1/2	1800	230/460	56	K456	05K49KN4573	✓	\$1,307	E5	1.8/0.9	31	14.06	3	17, N
	1800	208-230/460	56	K455	056T17F15921	✓	\$1,355	E5	2.3-2.4/1.2	30	16.23	3	68
	1200	208-230/460	56	K435	056T11F15533	✓	\$1,585	E5	2.4-2.7/1.35	32	16.23	6	68
	1200	230/460	56	K526	5K49MN6369	✓	\$1,803	E5	2.4/1.2	33	15.56	3	17, N
3/4	1800	230/460	56	K458	5K49PN4564	✓	\$1,616	E5	2.5/1.25	36	14.56	6	17, N
	1800	208-230/460	56	K436	056T17F15920	✓	\$1,664	E5	2.9-3/1.5	33	16.23	6	68
	1200	208-230/460	56	K437	056T11F15534	✓	\$1,894	E5	3.2-3.2/1.6	36	16.73	6	68
1	1800	230/460	56	K459A	056T17F99015	✓	\$2,109	E5	3.2/1.6	45	17.23	6	17
	1800	230/460	56	K438	056T17F15919	✓	\$2,109	E5	3.3/1.65	54	18.81	6	68
	1800	230/460	143T	K461A	143TTFR16065	✓	\$2,109	E5	3.2/1.6	48	17.66	6	17
	1200	230/460	145T	K2044	145TTFR16096	✓	\$2,339	E5	3.8/1.9	60	19.26	10	68
1 1/2	1800	230/460	56H	K440	056T17F15915	✓	\$2,117	E5	4.6/2.3	62	18.72	10	68
	1800	230/460	145T	K441	145TTFR16431	✓	\$2,117	E5	4.6/2.3	62	18.76	10	68
2	1800	230/460	145T	K2045	5KE49WN4571	✓	\$1,933	E5	5.6/2.8	54	18.00	10	d, 17
	1800	230/460	145T	K2045A	145TTFR16361	✓	\$2,126	E5	5.8/2.9	56	18.66	10	17



C-FACE FOOTLESS

HP	RPM	VOLTS	FRAME	CAT. NO.	MODEL NO.	STOCK	LIST PRICE	MULT. SYMB.	FL. AMPS	WT.	"C" DIM.	BRAKE RATING (LB/FT)	FOOT NOTES
1/4	1800	208-230/460	56C	K463	056T17F15916	✓	\$985	E5	1.4-1.4/0.7	30	15.73	3	20, 50, 17
1/3	1800	208-230/460	56C	K465	056T17F15918	✓	\$1,009	E5	1.5-1.6/0.8	30	15.73	3	68
	1200	208-230/460	56C	K466	056T11F15532	✓	\$1,103	E5	1.9-2.2/1.1	30	15.73	3	68
1/2	1800	230/460	56C	K457	5K49KN4563	✓	\$1,081	E5	1.8/0.9	31	14.06	3	N, 17
	1800	208-230/460	56C	K467	056T17F15914	✓	\$1,122	E5	2.3-2.4/1.2	31	16.23	3	68
	1200	208-230/460	56C	K468	056T11F15535	✓	\$1,315	E5	2.4-2.7/1.3	32	16.23	6	68
3/4	1800	230/460	56C	K460	5K49PN4565	✓	\$1,270	E5	2.5/1.25	37	14.56	6	N, 17
	1800	208-230/460	56C	K470	056T17F15913	✓	\$1,459	E5	2.9-3.0/1.5	32	16.23	6	68
	1200	208-230/460	56C	K471	056T11F15531	✓	\$1,672	E5	3.2-3.2/1.6	36	16.73	6	68
1	1800	230/460	143TC	K462A	143TTFR16066	✓	\$1,646	E5	3.2/1.6	45	17.73	6	17
	1800	230/460	56C	K472	056T17F15917	✓	\$1,646	E5	3.3/1.6	50	18.81	6	68
	1200	230/460	145TC	K473	145TTFR16095	✓	\$1,894	E5	3.8/1.9	58	19.26	10	68
1 1/2	1800	208-230/460	56C	K1494	5K49RN4570A	✓	\$1,673	E5	5.0/2.5	35	16.56	10	d, 17
	1800	230/460	56C	K1494A	056T17F99014	✓	\$1,909	E5	4.8/2.4	48	17.54	10	17
	1800	230/460	145TC	K474	145TTFR16430	✓	\$1,909	E5	4.6/2.3	55	18.76	10	68
2	1800	230/460	145TC	K2046	5KE49WN4572	✓	\$1,758	E5	5.6/2.8	44	18.00	10	d, 17
	1800	230/460	145TC	K2046A	145TTFR16362	✓	\$1,978	E5	5.8/2.9	46	18.73	10	17
	1800	230/460	145TC	K476	145TTFR16429	✓	\$1,978	E5	6.0/3.0	57	20.32	10	68

Catalog numbers (Cat No.) highlighted in bold blue are premium efficient.

NEMA Premium is a trademark of National Electrical Manufacturers Association. All Rights Reserved. Prices and specifications are subject to change without notice.

BRAKE MOTORS, THREE PHASE

C-FACE FOOTED, C-FACE FOOTED (REMOVABLE BASE FOR ROLLED STEEL FRAMES)

FEATURES

In addition to the single phase features on page 107:

- Meets or exceeds NEMA Premium® efficiencies. NEMA Premium models are in compliance with EISA 2007
- Brake has manual wear adjustment up to 25 lb-ft. for longer pad life
- Stearns® brakes, 56,000 series through 25 Lb-Ft, 87 series above 35 Lb-Ft and larger
- Brake leads routed through motor conduit box (TENV only)
- Universal mounting up to 15 Lb-Ft, C406 has verticle springs included, for larger brakes, see mod section
- CR²⁰⁰ corona resistant magnet wire (motor can be operated 10:1 variable torque and 2:1 constant torque)
- 1.15 service factor, 1.0 service factor where foot noted

HP	RPM	VOLTS	FRAME	CAT. NO.	MODEL NO.	STOCK	LIST PRICE	MULT. SYMB.	F.L. AMPS	WT.	"C" DIM.	BRAKE RATING (LB/FT)	FOOT NOTES
1/3	1800	208-230/460	56C	D450	056T17F5348	√	\$961	E5	1.5-1.6/0.8	30	15.73	3	6
	1200	208-230/460	56C	D451	056T11F5325	√	\$1,273	E5	1.9-2.2/1.1	30	15.73	3	6
1/2	1800	208-230/460	56C	D452	056T17F5349	√	\$1,081	E5	2.3-2.4/1.2	32	16.23	3	6
	1200	208-230/460	56C	D453	056T11F5326	√	\$1,589	E5	2.4-2.7/1.4	33	16.23	6	6
3/4	1800	208-230/460	56C	D454	056T17F5350	√	\$1,270	E5	2.9-3.0/1.5	33	16.23	6	6
	1200	208-230/460	56C	D455	056T11F5327	√	\$1,866	E5	3.1-3.2/1.6	37	16.73	6	6
1	1800	208-230/460	56C	D456	056T17F5357	√	\$1,508	E5	3.5-3.6/1.8	35	16.73	6	d, 6
	1800	230/460	56C	D456A	056T17F15655	√	\$1,710	E5	3.3/1.65	35	16.73	6	6
	1200	230/460	145TC	C400A	145TTFR16092	√	\$2,268	E5	3.8/1.9	60	19.26	10	6
1 1/2	1800	208-230/460	56HC	D457	56T17F5358	√	\$1,673	E5	5.0-4.8/2.4	39	16.72	10	d, 6
	1800	230/460	56HC	D457A	056T17F15677	√	\$1,900	E5	4.6/2.3	38	18.72	10	6
	1800	230/460	145TC	C401A	145TTFR16360	√	\$1,900	E5	4.6/2.3	62	18.76	10	6
	1200	230/460	184TC	C402A	184TTTTY16076	√	\$2,529	E5	5.2/2.6	80	18.39	15	AL, F, N
2	1800	208-230/460	145TC	C403	145TTFR5359	√	\$1,758	E5	6.0-5.8/2.9	68	18.77	10	d, 6
	1800	230/460	145TC	C403A	145TTFR16359	√	\$1,999	E5	6.0/3.0	62	18.77	10	6
	1200	230/460	184TC	C404A	184TTTTY16033	√	\$2,647	E5	6.4/3.2	90	19.23	15	AL, F, N
3	1800	230/460	182TC	C405	182TTTTL7034	√	\$2,327	E5	8.0/4.0	100	19.68	15	AL, F, N
5	1800	230/460	184TC	C406	184TTTTL7041	√	\$3,146	E5	12.4/6.2	115	20.68	25	AL, F, N, 17
7 1/2	1800	230/460	213TC	C407A	213TTTTL16038	√	\$4,697	E5	19.2/9.6	200	27.64	35	AL, F, N, 17
10	1800	230/460	215TC	C408	215TTTTL7050	√	\$5,164	E5	25.0/12.5	211	28.64	50	AL, F, N, 17

Catalog numbers (Cat No.) highlighted in bold blue are premium efficient.

Stearns is believed to be a trademark or trade name of Rexnord Corporation and is not owned or controlled by Regal Beloit Corporation.

NEMA Premium is a trademark of National Electrical Manufacturers Association. All Rights Reserved.

Prices and specifications are subject to change without notice.

FARM DUTY / AGRICULTURE, HIGH TORQUE MOTORS

SINGLE PHASE, TEFC MOTORS

FEATURES:

- Shaft end mechanically locked on C-face models (excludes 5K models)
- Ball bearings
- 1.15 service factor (except as noted)
- Capacitor start design for high starting torque
- Capacitor start/capacitor run design for higher efficiency, as noted
- Low temperature manual reset thermal protector
- Totally enclosed and fully gasketed construction for dirty environments
- Condensate drains
- Shaft slinger
- UL recognized and CSA certified



RIGID BASE

HP	RPM	VOLTS	FRAME	CAT. NO.	MODEL NO.	STOCK	LIST PRICE	MULT. SYMB.	FL. AMPS	WT.	"C" DIM.	FOOT NOTES
1/3	1800	115/208-230	56	F101	056C17F5324	√	\$456	F1	6.6/3.1-3.3	24	11.82	
	1800	115/230	56	C310	Century®	√	\$456	F1	5.2/2.6	27	11.10	N,19
1/2	1800	115/208-230	56	F102	056C17F5325	√	\$521	F1	8.8/4.2-4.4	25	11.82	
	1800	115/208-230	56	C661	5KC46GN0569Y	√	\$496	F1	0.0/4.5-4.5	44	11.83	
	1800	115/230	56	C311	Century	√	\$521	F1	7.2/3.6	28	12.20	19
	3600	115/230	56	C664	5KC36LN4003Y	√	\$363	F1	7.4/3.7	17	11.36	
3/4	1800	115/208-230	56	F103	056C17F5326	√	\$622	F1	11.0/5.4-5.5	29	12.32	
	1800	230/115	56	C312	Century	√	\$622	F1	5.2/10.4	32	12.60	19
1	1800	115/208-230	143T	Z123	143TCFR5328	√	\$720	S1	13.4/6.8-6.7	31	12.87	
	1800	115/230	56	F10E1	5KC49TN0063Y	√	\$677	F1	13.2/6.6	37	12.96	d,17
	1800	115/208-230	56	F104	056C17F5327	√	\$677	F1	13.4/6.8-6.7	30	12.82	
	1800	230/115	56	C313	Century	√	\$677	F1	6.0/12.0	36	13.40	19
	3600	115/230	56	C663	5KC49NN2419Y	√	\$499	F1	13.2/6.6	29	12.43	19
1 1/2	1800	115/208-230	145T	F15E1	5KCR48WN0292Y	√	\$848	S1	14.5/7.1-7.3	44	14.07	ES, 1
	1800	115/208-230	145T	Z118	145TBFR5328	√	\$848	S1	15.2/8.2-7.6	40	13.87	1
	1800	230/115	145T	K104	Century	√	\$848	S1	7.5/15.0	43	15.00	1
	1800	115/208-230	56H	F105	056B17F5307	√	\$832	F1	15.2/8.2-7.6	41	13.82	ES, 1
	1800	115/208-230	56H	C659	5KCR48WN0566Y	√	\$732	F1	14.5/7.1-7.3	44	13.82	ES, 1
	1800	115/230	56	C660	5KC49TN0568Y	√	\$638	F1	13.2/6.6	38	12.96	ES
	1800	230/115	56	C314	Century	√	\$832	F1	7.5/15.0	28	13.90	1
	3600	115/230	56	C662	5KC49SN2418U	√	\$653	F1	16.4/8.2	35	12.96	ES
2	1800	115/230	145T	Z128	145TBFR5341	√	\$942	S1	18.8/9.4	49	14.87	1
	1800	115/230	182T	Z119	182TCFW7072	√	\$1,026	S1	24.0/12.0	66	14.46	F, 2, 13
	1800	115/230	182T	K213M2	Century	√	\$1,026	S1	24.0/12.0	91	14.46	F, 2, 13
	1800	230/115	182TZ	K119	Century	√	\$1,026	S1	8.7/17.4	50	15.50	1
	1800	230	56HZ	C319	Century	√	\$942	F1	9.0	48	15.00	1
3	1800	230	184T	Z120A	184TBFW17045	√	\$1,278	S1	14.2	92	14.96	1, 13
	1800	230	184T	K214M2	Century	√	\$1,278	S1	19.0	90	16.46	2, 13
5	1800	230	184T	Z121A	184TBFW7737	√	\$1,556	S1	19.5	103	17.45	1, 13
	1800	230	184T	K215M2	Century	√	\$1,556	S1	19.5	105	17.46	1, 13, F
	1800	230	213T	K310M2	Century	√	\$1,740	S1	23.0	125	17.62	1, AL
7 1/2	1800	230	215T	Z122	215TBFW7029	√	\$2,308	S1	30.0	138	21.48	1
	1800	230	215T	K311M2	Century	√	\$2,308	S1	34.0	154	19.10	ES, AL
10	1800	230	215T	K312M2	Century	√	\$3,046	S1	38.0	163	19.10	ES, AL
16	1800	230	256TZ	Z319	256TBDX17035	√	\$4,960	S1	61.0	308	25.52	ES

C-FACE FOOTED (RIGID BASE)

HP	RPM	VOLTS	FRAME	CAT. NO.	MODEL NO.	STOCK	LIST PRICE	MULT. SYMB.	FL. AMPS	WT.	"C" DIM.	FOOT NOTES
1/3	1800	115/208-230	56C	F131	056C17F5358	√	\$553	F1	6.6/3.1-3.3	23	11.82	
	1800	115/230	56C	C310C	Century	√	\$553	F1	5.2/2.6	29	11.10	N, 19
1/2	1800	115/208-230	56C	F132	056C17F5912	√	\$618	F1	8.8/4.2-4.4	25	11.82	
	1800	115/230	56C	C311C	Century	√	\$618	F1	7.2/3.6	28	12.20	19
3/4	1800	115/208-230	56C	F133	056C17F5913	√	\$719	F1	11.5/4.5-5.5	29	12.32	
	1800	115/230	56C	C312C	Century	√	\$719	F1	10.4/5.2	34	12.60	
1	1800	115/208-230	56C	F134	056C17F5914	√	\$773	F1	13.4/6.8-6.7	31	12.82	
	1800	115/230	56C	C313C	Century	√	\$773	F1	12.0/6.0	38	13.40	
1 1/2	1800	115/208-230	56HC	F135	056B17F5584	√	\$929	F1	15.2/8.2-7.6	41	13.82	1, 5
	1800	115/230	56C	C314C	Century	√	\$929	F1	15.0/7.5	44	13.90	1
2	1800	115/230	56HC	K319	056B17F5319	√	\$953	F1	18.8/9.4	50	14.82	1, 5
3	1800	230	184TC	I314A	184TBFW7041	√	\$1,428	S1	12.8	86	14.96	1, 13
5	1800	230	184TC	I315A	184TBFW7034	√	\$1,704	S1	19.5	101	17.47	1, 13

FARM DUTY / AGRICULTURE, EXTRA-HIGH TORQUE CHORE MOTOR®

SINGLE PHASE, TEFC, RIGID BASE MOTORS

FEATURES:

- Class F insulation
- 1.15 Service factor (except as noted)
- Ball bearings
- 300% and greater starting torque for hard-to-start applications
- Totally enclosed and fully gasketed for dirty environments
- 213/215TZ models have 1-1/8" shaft, 182TZ model has 7/8" shaft
- Manual reset thermal protector
- Condensate drains
- Shaft slinger
- UL recognized and CSA certified



HP	RPM	VOLTS	FRAME	CAT. NO.	MODEL NO.	STOCK	LIST PRICE	MULT. SYMB.	FL. AMPS	WT.	"C" DIM.	FOOT NOTES
2	1800	115/230	182TZ	Z112A	182TCFW9061	√	\$1,087	S1	24.0/12.0	68	14.46	2, 13
3	1800	230	184T	Z113A	184TCFW9057	√	\$1,352	S1	19.0	90	16.46	2, 13
5	1800	208-230	184T	Z114A	184TBFW7070	√	\$1,648	S1	23.8/21.8	98	14.46	1, 13
	1800	230	213TZ	Z117	213TBFW7027	√	\$1,833	S1	23.0	119	18.73	1
7.5	1800	230	215TZ	Z115	215TBFW7028	√	\$2,446	S1	32.0	155	21.48	1
10	1800	230	215T	Z116	215TBFW7044	√	\$3,046	S1	40.0	133	21.48	1, 17
15	1800	230	256T	Z129	256TBF17026	√	\$5,320	S1	64.0	309	27.65	1, 17

CENTURY® FARM RATED® MOTORS

EXTRA HIGH TORQUE, SINGLE PHASE, TEFC RIGID BASE & RIGID BASE WITH C-FACE

FEATURES:

- High starting torque
- 1.00 service factor
- Ball bearings
- Class B or F insulation, as noted
- Reversible
- Removable condensate drain plugs
- Manual reset thermal protector
- All parts are corrosion resistant
- UL recognized and CSA certified



HP	RPM	VOLTS	FRAME	CAT. NO.	MODEL NO.	STOCK	LIST PRICE	MULT. SYMB.	FL. AMPS	WT.	"C" DIM.	FOOT NOTES
1	1800	230/115	143T	K102V1	Century®	√	\$720	S1	14.6/7.3	38	14.20	2, 17
	1800	230/115	143TC	K102C	Century	√	\$720	S1	14.6/7.3	40	14.40	2, 17
1.5	1800	230/115	145T	K103	Century	√	\$848	S1	16.2/8.1	42	14.20	ES, 17
	1800	230/115	145TC	K103C	Century	√	\$848	S1	16.2/8.1	44	14.40	ES, 17
2	1800	115/230	182TZ	K204M2	Century	√	\$1,196	S1	24.8/12.4	65	14.50	2
3	1800	230	184T	K205M2	Century	√	\$1,443	S1	13.0	93	15.50	ES
	1800	230	184TC	K205CM2	Century	√	\$1,604	S1	13.0	96	15.50	ES
5	1800	230	184T	K208M2	Century	√	\$1,648	S1	21.5	106	17.50	ES
	1800	230	184TC	K208CM2	Century	√	\$1,765	S1	21.7	106	17.50	ES
	1800	230	215TZ	K300M2	Century	√	\$1,880	S1	26.0	132	19.20	ES, 17, AL
7.5	1800	230	215TZ	K301M2	Century	√	\$2,446	S1	38.0	131	19.20	ES, 17, AL
	1800	230	215TCZ	K301CM2	Century	√	\$2,446	S1	38.0	131	19.90	ES, 17, AL
10	1800	230	215T	K302M2	Century	√	\$3,046	S1	39.0	146	19.20	ES, 17, AL
	1800	230	215TCZ	K302CM2	Century	√	\$3,046	S1	39.0	149	19.90	ES, 17, AL

FARM DUTY / AGRICULTURE, AUGER DRIVE MOTORS

SINGLE PHASE, TEFC, N FLANGE MOTORS

FEATURES:

- NEMA® N flange mounting
- Manual reset thermal protector
- 48NZ: 1/2" dia. X 1.5" long shaft with flat
- 56NZ: 5/8" dia. X 2.06" long shaft with flat
- Extended (ODE) shaft with flats for manual jogging
- F1201, F1202, F1203, F1204, and F1205 utilize a solid state electronic starting switch
- Ball bearings
- UL recognized and CSA certified



HP	RPM	VOLTS	FRAME	CAT. NO.	MODEL NO.	STOCK	LIST PRICE	MULT. SYMB.	FL. AMPS	WT.	"C" DIM.	FOOT NOTES
1/3	1800	115/230	48NY	HG646	5KH39QN9508Y	√	\$489	F1	5.3/2.7	22	11.07	N, 3, 83
	1800	115/208-230	56NY	C1291	5KC46GN0075U	√	\$408	F1	5.8/2.8-2.9	21	12.00	
	1800	115/230	48NZ	F1201	048C17F11005	√	\$542	F1	6.2/3.1	22	10.31	E, 2
1/2	1800/1500	115/208-230	56NY	C1292	5KC46JN0076U	√	\$539	F1	8.4/4.0-4.2	23	12.00	2, 49, 50
	1800	115/208-230	48NZ	F1202	048C17F11006	√	\$590	F1	8.0/3.8-4.0	22	10.56	E, 2
3/4	1800	115/208-230	56NY	C1293	5KCR49PN0077U	√	\$636	F1	8.4/4.5-4.2	31	13.13	ES, 1
	1800	115/208-230	48NZ	F1203	048C17F11007	√	\$687	F1	10.8/5.3-5.4	20	11.31	E, 2
1	1800/1500	115/208-230	56NY	C1294	5KCR49UN0079U	√	\$712	F1	10.8/6.0-5.4	40	14.51	ES, 1, 50, 83
	1800	115/230	56NZ	F1204	056C17F15537	√	\$763	F1	13.4/6.7	36	13.38	E, 2
1.5	1800	115/208-230	56NY	C1295	5KCR49VWN0295U	√	\$859	F1	14.5/7.1-7.3	44	14.51	ES, 1, 83
	1800	115/230	56NZ	F1205	056B17F15516	√	\$918	F1	15.2/7.6	45	14.38	E, 1

FARM DUTY / AUGER DRIVE MOTORS

SINGLE PHASE & THREE PHASE, TEFC OR AS NOTED, N FLANGE MOTORS

FEATURES:

- High starting torque
- Manual reset thermal protector
- 1.0 service factor
- Double sealed ball bearings
- Reversible
- Torque switch and governor
- UL recognized and CSA certified



HP	RPM	VOLTS	FRAME	CAT. NO.	MODEL NO.	STOCK	LIST PRICE	MULT. SYMB.	FL. AMPS	WT.	"C" DIM.	FOOT NOTES
Single Phase												
1/3	1800	115/230	56N	C330	Century®	√	\$487	F1	5.5/2.8	27	9.60	N, 17
1/2	1800	115/230	56N	C331	Century	√	\$539	F1	7.2/3.6	30	12.40	17
3/4	1800	230/115	56N	C332	Century	√	\$652	F1	5.2/10.4	32	12.40	17
1	1800	230/115	56N	C333	Century	√	\$741	F1	6.0/12.0	36	13.30	17
1 1/2	1800	230/115	56N	C340	Century	√	\$1019	F1	6.6/13.2	45	14.50	17
Three Phase												
1/3	1800	208-230/460	56N	C345	Century	√	\$516	F1	1.2-1.2/0.6	23	8.99	N
1/2	1800	208-230/460	56N	C346	Century	√	\$590	F1	1.7-1.7/0.85	27	10.78	17
3/4	1800	208-230/460	56N	C347	Century	√	\$687	F1	2.4-2.4/1.2	25	10.78	17
1	1800	200-230/460	56N	C348ES	Century	√	\$898	F1	3.3-3.3/1.65	29	14.30	17
1 1/2	1800	200-230/460	56N	C349ES	Century	√	\$1,183	F1	4.6/2.3	38	14.80	17

GRAIN STIRRING, SINGLE PHASE MOTORS

TEFC, RIGID BASE MOTORS

APPLICATIONS:

Definite purpose for grain stirring systems inside grain bins.

FEATURES:

- 1.15 service factor
- Fully gasketed construction to keep grain dust out
- 7/8" diameter shaft
- Fan/fan guard on shaft end keeps grain dust out of motor
- Durable powder coat paint
- Manual reset thermal protector
- Ball bearings
- UL recognized and CSA certified



HP	RPM	VOLTS	FRAME	CAT. NO.	MODEL NO.	STOCK	LIST PRICE	MULT. SYMB.	F.L. AMPS	WT.	"C" DIM.	FOOT NOTES
1 1/2	1800	115/208-230	56HZ	X902	056B17F5324		\$728	F1	15.2/8.2-7.6	46	13.21	1, 5
	1800	230	56Y	C317V1	Century®	√	\$780	F1	7.4	32	13.28	1, 301

FARM DUTY, CAPACITOR START OR SPLIT PHASE MOTORS AS NOTED

TEAO, RIGID OR RESILIENT BASE AS NOTED - HIGH EFFICIENCY MOTORS

APPLICATIONS:

Designed for demanding agricultural belt drive fan applications such as poultry house fans and barn exhaust fans. **Totally Enclosed Air Over models must be mounted within the airstream for proper cooling.**

FEATURES:

- Capacitor start/capacitor run design for higher efficiency, as noted
- Suitable for belted loads
- Ball bearings
- Continuous duty
- Automatic reset thermal protector
- Fully gasketed
- UL recognized and CSA certified



FARM DUTY / AGRICULTURAL

HP	RPM	VOLTS	FRAME	CAT. NO.	MODEL NO.	STOCK	LIST PRICE	MULT. SYMB.	F.L. AMPS	WT.	"C" DIM.	FOOT NOTES
1/3	1800	230/115	48Z	F500L	Century	√	\$461	F1	2.2/4.4	13	11.21	3, 127
1/2	1800	115/230	56	X913	056B17T20	√	\$486	F1	4.6/2.3	22	10.47	1
	1800	230/115	56Z	F501	Century	√	\$450	F1	3.5/7.0	24	11.07	3, 127
	1800	230/115	56	F502	Century	√	\$386	F1	3.5/7.0	25	11.07	3
	900	208-230	56Y	F781	5KCP49UN9838S	√	\$497	F1	3.7-3.6	40	11.91	93
	1800	230/115	56	C580	Century	√	\$558	F1	3.2/6.4	30	11.44	1
3/4	1800	230/115	56	C581	Century	√	\$683	F1	3.6/7.2	35	11.94	1
1	1800	230/115	56	C582	Century	√	\$767	F1	4.8/9.6	39	12.44	1
	1800	115/230	56	X912	056B17T5303	√	\$636	F1	9.2/4.6	32	11.44	1
	1725/1425	230/115	56	C782RB	Century	√	\$699	F1	4.3/8.6-5.2/10.4	41	12.20	1, 6, 68

FARM DUTY, PSC MOTORS

TEAO, RESILIENT BASE - THRU BOLT

VARIABLE SPEED MOTORS

APPLICATIONS:

Designed for demanding agricultural fan applications such as poultry houses and barn exhaust fans. Must be mounted within the airstream for proper cooling. Variable speed capabilities when used with a single phase speed control unit – NOT supplied. Super variable speed motors, catalog X030, X031, and X032, are designed for lower temperature rise throughout a greater speed range.

FEATURES:

- Ball bearings
- Continuous duty
- Extended thru-bolts
- Automatic reset thermal protector
- Fully gasketed
- 48/56 Frame mounting holes
- 1/2" dia. x 2-1/2" long shaft with two flats, 90° apart
- UL recognized and CSA certified



HP	RPM	VOLTS	FRAME	CAT. NO.	MODEL NO.	STOCK	LIST PRICE	MULT. SYMB.	FL. AMPS	WT.	"C" DIM.	FOOT NOTES
1/4	1625	115/230	48YZ	X030	048A17T118	√	\$347	F1	3.6/1.8	20	11.06	
	1625	115/230	48YZ	X024	048A17T2002	√	\$284	F1	3.2/1.6	18	10.09	
	1075	115/230	48YZ	X027	048A11T2021	√	\$309	F1	3.2/1.6	15	10.09	
1/3	1625	115/230	48YZ	X031	048A17T237	√	\$384	F1	3.8/1.9	23	11.81	
	1625	115/230	48YZ	X025	048A17T2003	√	\$316	F1	4.4/2.2	18	10.09	
	1075	115/230	48YZ	X028	048A11T2022	√	\$335	F1	4.2/2.1	21	10.84	
1/2	1625	115/230	48YZ	X032	048A17T119	√	\$424	F1	5.4/2.7	24	11.81	
	1625	115/230	48YZ	X026	048A17T2004	√	\$343	F1	6.0/3.0	22	10.84	
	1075	115/230	48YZ	X029	048A11T2023	√	\$359	F1	6.4/3.2	22	10.84	

CENTURY® INSTANT REVERSE FARM MOTORS

SINGLE PHASE – CAPACITOR START

TEFC – RIGID BASE

APPLICATIONS:

Reversing feeders, door openers, gates, machine tools.

FEATURES:

- Solid state switching
- Low temperature grease
- Manual reset overload protector



HP	RPM	VOLTS	FRAME	CAT. NO.	MODEL NO.	STOCK	LIST PRICE	MULT. SYMB.	FL. AMPS	WT.	"C" DIM.	FOOT NOTES
1/2	1800	115/230	56	C337	Century®	√	\$778	F1	7.2/3.6	28	12.60	
3/4	1800	115/230	56	C338	Century	√	\$825	F1	10.4/5.2	36	13.40	
1	1800	115/230	56	C339	Century	√	\$888	F1	13.0/6.5	35	13.40	

FARM DUTY / AGRICULTURAL MOTORS

SINGLE PHASE, TEAO, RESILIENT BASE-THRU BOLT MOTORS

Features:

- Split phase and PSC, as noted
- Ball bearings
- Extended thru-bolts on X1903, X1904, P250, and P251
- 48Z frame has 1/2" dia. x 2-1/2" long shaft with two flats
- 56Z frame has 1/2" dia. x 1-7/8" long with 1-5/8" flat
- 48Y & 48YZ have 48/56 fr. mounting holes
- 1.0 service factor (except as noted)
- Thermal protection, as noted
- Fully gasketed



HP	RPM	VOLTS	FRAME	OVER LOAD	CAT. NO.	MODEL NO.	STOCK	LIST PRICE	MULT. SYMB.	FL. AMPS	WT.	"C" DIM.	FOOT NOTES	
1/6	1800	115	48	AUTO	HG196	5KH32GN42S	✓	\$324	F1	3.5	13	8.94	3	
	1800	115	48	NONE	H195	5KH32GN42	✓	\$316	F1	3.5	13	8.94	3	
	1200	115	48	AUTO	H198	5KH35MN132S	✓	\$485	F1	3.7	17	9.57	3	
	1200	115	48	NONE	H197	5KH35MN132	✓	\$467	F1	3.7	17	9.57	3	
1/4	1800	115	48Z	AUTO	X1903	5KHC32FNA499S	✓	\$252	F1	5.1	14	9.68	3, 9	
	1800	115/208-230	48	AUTO	H649	5KHC39QN9575T	✓	\$524	F1	3.0/1.6-1.5	16	10.40	3	
	1800	115	48	AUTO	H135	5KH32FN3122S	✓	\$343	F1	5.1	15	8.94	3	
	1800	115/230	48Z	AUTO	P250	5KCP35KNB057S	✓	\$333	F1	3.6/1.8	16	10.57	93	
	1800	115	48	NONE	H134	5KH32FN3122	✓	\$325	F1	5.1	15	8.94	3	
	1800	230	48	AUTO	H277	5KH33KN20S	✓	\$383	F1	2.3	15	9.19	3	
	1800/1200	115	48	NONE	H203	5KH36PN106	✓	\$398	F1	4.2/2.7	20	10.00	3	
	1200	115	56	AUTO	H137	5KH49MN6057S	✓	\$571	F1	5.6	22	10.48	3	
	1200	115	56	NONE	H136	5KH49MN6057	✓	\$555	F1	5.6	23	10.48	3	
	1/3	1800	115	48Z	AUTO	X1904	5KH33JNA500S	✓	\$284	F1	6.2	15	9.93	3, 9
1800		115	48	AUTO	H139	5KH33JN3121S	✓	\$406	F1	6.2	18	9.19	3	
1800		115	48	NONE	HG138	5KH33JN3121	✓	\$389	F1	6.2	18	9.19	3	
1800		115/208-230	48	AUTO	HG648	5KHC39QN9581T	✓	\$567	F1	4.1/2.1-2.0	17	10.40	3	
1800		230	48	NONE	HG140	5KH36NN37	✓	\$408	F1	2.5	18	10.00	3	
1800		230	48	AUTO	HG141	5KH36NN37S	✓	\$416	F1	2.5	18	10.00	3	
1200		115/230	56	AUTO	HG699	5KH49PN6056S	✓	\$663	F1	7.0/3.5	26	11.48	3	
1200		115/230	56	NONE	HG142	5KH49PN6056	✓	\$644	F1	7.0/3.5	27	11.48	3	
1/2		1800	115/208-230	56	AUTO	H247	5KH42JN0328S	✓	\$386	F1	8.0/4.0-4.0	21	10.05	3
		1200	115/230	48Z	AUTO	P251	5KCP36NNB059S	✓	\$429	F1	7.2/3.6	18	11.00	93
	1800	115/208-230	56	NONE	H276	5KH42JN0328	✓	\$545	F1	8.0/4.0-4.0	21	10.05	3	
	1800	115/208-230	56	AUTO	H647	5KHC39QN9584X	✓	\$601	F1	5.2/2.7-2.6	19	10.05	3	
	1800	115	56	NONE	HG143	5KH42GN0337	✓	\$518	F1	8.0	21	10.05	3, 19	
3/4	1800	115/208-230	56	AUTO	C1314	5KCR49PN0492S	✓	\$499	F1	7.0/3.8-3.5	30	11.38	1, 50, 55, 111	
	1800	115/208-230	56	AUTO	C1303	5KCR46NN0264T	✓	\$638	F1	8.2/4.0-4.1	28	10.78	1, 19	
1	1800	115/208-230	56	AUTO	C1315	5KCR49SN0493S	✓	\$585	F1	10.6/5.5-5.3	34	11.85	1, 111	
	1800	115/208-230	56	AUTO	C1302	5KCR49SN0042S	✓	\$668	F1	9.6/5.2-4.8	35	11.91	1, 50, 55, 11	
1 1/2	1800	115/208-230	56	AUTO	C1909	5KCR49ZN0785S	✓	\$687	F1	14.0/7.2-7.0	49	13.96	1, 50, 55, 111	

FARM DUTY / AGRICULTURAL

CENTURY® FARM BUILDING DIRECT DRIVE FAN MOTORS

SPLIT PHASE DESIGN, TEAO MOTORS

FEATURES:

- Double sealed ball bearings
- Fully gasketed

HP	RPM	VOLTS	FRAME	OVER LOAD	CAT. NO.	MODEL NO.	STOCK	LIST PRICE	MULT. SYMB.	FL. AMPS	WT.	"C" DIM.	FOOT NOTES
Thru-bolt Mount (10-32 UNF-2A)													
1/3	1725	115	56Z	AUTO	F683	Century®	√	\$450	F1	4.8	25	11.10	3
1/3~.07	1725/850	115	56Y	AUTO	F684	Century	√	\$591	F1	5.5/3.1	27	11.10	3
1/2	900	115/230	56Z	AUTO	C048	Century	√	\$567	F1	6.6/3.3	33	12.10	93, 104
1	850/725	230	56CZ	AUTO	C783	Century	√	\$915	F1	5.1	44	14.20	12, 16, 68, 93

CENTURY® COW COOLER FARM MOTORS

CAPACITOR START, CAPACITOR RUN, TEAO MOTORS

FEATURES:

- Low starting torque
- Single phase
- Energy efficient
- Rigid base



HP	RPM	VOLTS	FRAME	OVER LOAD	CAT. NO.	MODEL NO.	STOCK	LIST PRICE	MULT. SYMB.	FL. AMPS	WT.	"C" DIM.	FOOT NOTES
1	1725	115/230	56H	MANUAL	C593	Century	√	\$621	F1	9.6/4.8	38	12.70	ES
1-1/2	1725	115/230	56H	MANUAL	C594	Century	√	\$668	F1	17.0/8.5	38	12.70	ES
1.0 ~.29	1725/1140	115	56H	MANUAL	C596	Century	√	\$852	F1	11.4/6.4	35	12.70	ES
1.0 ~.29	1725/1140	230	56H	MANUAL	C597	Century	√	\$852	F1	5.3/3.0	35	12.20	ES
1.5 ~.44	1725/1140	115	56H	MANUAL	C595	Century	√	\$948	F1	15.6/9.1	43	13.90	ES
1.5 ~.44	1725/1140	230	56H	MANUAL	C598	Century	√	\$948	F1	7.4/4.4	45	13.20	ES

CENTURY POULTRY DUTY MOTORS

CAPACITOR START, CAPACITOR RUN, TEAO MOTORS

FEATURES:

- High starting torque
- Gasketed conduit box
- Energy efficient
- 1.30 service factor
- 50/60 Hz
- Resilient or rigid base as noted



HP	RPM	VOLTS	FRAME	OVER LOAD	CAT. NO.	MODEL NO.	STOCK	LIST PRICE	MULT. SYMB.	FL. AMPS	WT.	"C" DIM.	FOOT NOTES
1/2	1725/1425	115/208-230	56	AUTO	PD1050AV1	Century	√	\$442	F1	4.8/2.4	26	10.80	ES, 59
1	1725/1425	115/230	56	AUTO	PD6104AV2	Century	√	\$733	F1	9.0/4.5	42	12.70	ES, 59
	1725/1425	115/230	56	AUTO	PD6104AV3	Century	√	\$699	F1	9.0/4.5	40	12.80	ES, 12, 59

CROP DRYER, SINGLE PHASE MOTORS

DRIPPROOF/AIR OVER, RIGID BASE MOTORS

APPLICATIONS:

Crop dryers with air over/fan on shaft designs.

FEATURES:

- Double sealed ball bearings
- Continuous duty
- Class F insulation system
- Thermostats for thermal overload protection (auto reset protector on Z304)
- 34" long leads for ease of installation
- Keyed shafts with 1/4"-20 UNC tapped hole in end
- Capacitors included, shipped loose on catalog Z307 and Z308, mounted on all other models
- Extra nameplate included, loose, for remote mounting



HP	RPM	VOLTS	FRAME	OVER LOAD	CAT. NO.	MODEL NO.	STOCK	LIST PRICE	MULT. SYMB.	FL. AMPS	WT.	"C" DIM.	FOOT NOTES
3-4.5	3600	230	145TZ	AUTO	Z304	145TBDR5309	√	\$974	S1	13.0-19.0	43	13.74	1
3-5	3600	230	182TZ	TSTAT	Z309	182TCDR7013		\$1,170	S1	15.8-25.3	67	15.00	2
5-7	3600	200-230	184TZ	TSTAT	K220M2	Century®	√	\$1,425	S1	23.0-21.3/33.0-29.0	107	17.38	69, 93
5-7.5	3600	230	184TZ	TSTAT	Z305A	184TCDW7615	√	\$1,425	S1	27.2-35.0	98	15.88	2
7-9	3600	230	184TZ	TSTAT	Z306A	184TCDW7617	√	\$1,608	S1	36.5-46.0	83	14.88	2
7-10	3600	230	184TZ	TSTAT	Z307A	184TBDW7009	√	\$1,795	S1	31.0-42.0	95	15.88	1
7-10.5	3600	200-230	184TZ	TSTAT	K221M2	Century	√	\$1,795	S1	31.5-27.0/47.4-40.0	84	16.88	69, 93
7.5-10	3600	230	184TZ	TSTAT	Z313	184TBDR7324		\$1,795	S1	30.0-42.0	89	16.43	1
7.5-10.5	3600	230	215TZ	TSTAT	Z314	215TCDW7012		\$2,097	S1	37.0-49.5	139	19.16	2
		200-230	215TZ	TSTAT	K320M2	Century	√	\$2,097	S1	33.4-34.5/46.0-44.0	147	19.08	69, 93
10-12	1800	230	215TZ	TSTAT	K327M2	Century	√	\$2,670	S1	39.6/47.6	147	21.32	93
10-14	3600	200-230	215TZ	TSTAT	K321M2	Century	√	\$2,311	S1	44.5-40.5/62.5-53.8	147	20.32	69, 93
10-15	3600	230	215TZ	TSTAT	Z315	215TBDW7013		\$2,415	S1	39.5-61.5	159	20.42	1
	3600	230	215TZ	TSTAT	Z308	215TCDW7003	√	\$2,415	S1	46.0-71.0	135	18.16	2

TOTALLY ENCLOSED AIR OVER

HP	RPM	VOLTS	FRAME	OVER LOAD	CAT. NO.	MODEL NO.	STOCK	LIST PRICE	MULT. SYMB.	FL. AMPS	WT.	"C" DIM.	FOOT NOTES
7-10.5	3600	200-230	184TZ	TSTAT	K236M2	Century	√	\$1,805	S1	35.0-31.0/47.0-41.0	109	18.38	69, 93

FARM DUTY/AGRICULTURAL MOTORS

SINGLE PHASE, TEAO, DIRECT DRIVE-THRU BOLT MOTORS

FEATURES:

- Economical split phase design
- X909 has 1/2" diameter x 1.5" shaft with flat
- X910 and X911 have 1/2" dia. X2-1/2" long shaft with two flats, 90 degrees apart
- Thermal protection, as noted
- Ball bearings



SINGLE SPEED

HP	RPM	VOLTS	FRAME	OVER LOAD	CAT. NO.	MODEL NO.	STOCK	LIST PRICE	MULT. SYMB.	FL. AMPS	WT.	"C" DIM.	FOOT NOTES
1/4	1725	115	48Y	MANUAL	X909	048S17T2004	√	\$249	F1	4.0	10	7.62	3
1/2	900	208-230	56Y	AUTO	F780	5KCP49UN9837S	√	\$486	F1	3.7-3.6	40	11.91	93

TWO SPEED

HP	RPM	VOLTS	FRAME	OVER LOAD	CAT. NO.	MODEL NO.	STOCK	LIST PRICE	MULT. SYMB.	FL. AMPS	WT.	"C" DIM.	FOOT NOTES
1/4	1725/1140	115	48YZ	AUTO	X910	048S17T366	√	\$322	F1	4.1/2.5	17	11.09	3
1/3	1725/1140	115	48YZ	AUTO	X911	048S17T365	√	\$405	F1	5.3/2.9	18	11.34	3

INCUBATOR/HATCHERY VENT FAN

SINGLE PHASE (PSC), TEAO, THRU-BOLT

HP	RPM	VOLTS	FRAME	CAT. NO.	MODEL NO.	STOCK	LIST PRICE	MULT. SYMB.	FL. AMPS @ LOW SPEED	WT.	"C" DIM.	FOOT NOTES
1/3	1800	115/230	48Z	P239	5KCP33GNA471S	√	\$561	F1	4.0/2.0	15	10.18	d



CENTER PIVOT IRRIGATION

THREE PHASE, TEFC, C-FACE FOOTLESS

HP	RPM	VOLTS	FRAME	CAT. NO.	MODEL NO.	STOCK	LIST PRICE	MULT. SYMB.	FL. AMPS	WT.	"C" DIM.	FOOT NOTES
1	1800/1500	460/380	56C	K1476	5K49JN4051T	√	\$615	F1	2.0/2.1	23	12.08	50
1 1/2	1800/1500	460/380	56C	K1438	5K49NN4052T	√	\$695	F1	2.4/2.7	29	12.08	50

FARM DUTY / AGRICULTURAL

CROP DRYER, THREE PHASE MOTORS

OPEN/AIR OVER, RIGID BASE MOTORS

APPLICATIONS:

Crop dryers with air over/fan on shaft designs where three phase power is available.

FEATURES:

- Ball bearings
- Thermostats for thermal overload protection
- 34" long leads exit elbow connector in bracket
- Keyed shafts with 1/4"-20 UNC tapped hole in end
- Extra nameplate included, loose, for remote mounting
- Continuous duty
- Class F insulation



OPEN/AIR OVER

HP	RPM	VOLTS	FRAME	CAT. NO.	MODEL NO.	STOCK	LIST PRICE	MULT. SYMB.	FL. AMPS @ LOW SPEED	WT.	"C" DIM.	FOOT NOTES
5-7	3600	208-220/440	184TZ	Y302A	184TTDW7611	√	\$1,194	E6	13.8-13.2/6.6	71	13.16	13
7-10	3600	208-220/440	184TZ	Y1303	184TTDW7612	√	\$1,265	E6	20.0-19.2/9.6	69	16.19	13
10-15	3600	208-220/440	215TZ	Y304	215TTDW7301	√	\$1,670	E6	28-26.1/13.1	95	17.41	2,13

TOTALLY ENCLOSED AIR OVER

HP	RPM	VOLTS	FRAME	CAT. NO.	MODEL NO.	STOCK	LIST PRICE	MULT. SYMB.	FL. AMPS @ LOW SPEED	WT.	"C" DIM.	FOOT NOTES
5-7	3600	208-230/460	184TZ	R244M2	Century®	√	\$1,304	E6	13.1-12.0/6.0	74	15.38	69
7.5-10.5	3600	208-230/460	184TZ	R243M2	Century	√	\$1,456	E6	19.4-17.2/8.7	105	17.38	69
10-14	3600	230/460	215TZ	R327M2	Century	√	\$1,770	E6	29.0/15.2	109	19.98	69, AL

CENTURY® REPLACEMENT ZERO MILK TANK FARM MOTORS

PMDC MOTOR – TOTALLY ENCLOSED NON-VENTILATED – 95 VDC 950 RPM
INTERMITTENT-DUTY – 1/2 THRU 1 HP MOTORS

FEATURES:

- Double Sealed Ball Bearings
- Round frame
- Non-toxic, white epoxy paint, FDA approved for contact with food
- Shaft seal
- All bracket to frame fits and terminal cover have internal o-ring
- Gasketed brush access covers
- 1/2" - 14 tapped conduit hole
- Stainless steel shaft, with or without o-ring grooves on shaft



HP	RPM	VOLTS	FRAME	CAT. NO.	MODEL NO.	STOCK	LIST PRICE	MULT. SYMB.	F.L. AMPS	WT.	"C" DIM.	O-RING GROOVES
1/2	950	95	42	DC146	Century®	√	\$1,475	D1	5.6	33	14.10	No
1/2	950	95	42	DC156	Century	√	\$1,521	D1	5.6	33	14.10	Yes
1	950	95	42	DC147	Century	√	\$2,028	D1	11.0	39	15.60	No
1	950	95	42	DC157	Century	√	\$2,074	D1	11.0	39	15.60	Yes

CENTURY MILK PUMP FARM MOTORS

SINGLE PHASE & THREE PHASE – PERMANENT SPLIT CAPACITOR
TOTALLY-ENCLOSED NON-VENTILATED – RIGID BASE – 3600 RPM – 1/2 THRU 1 HP MOTORS

FEATURES:

- Weatherproof features for washdown
- Cast iron NEMA® "C" end bracket
- Stainless steel shaft
- Non-reversible, CW rotation facing end opposite shaft
- Auto overload protector
- ACME right hand threads - applies to only - B587, B584, B585, B586, B596, B599



HP	RPM	VOLTS	FRAME	CAT. NO.	MODEL NO.	STOCK	LIST PRICE	MULT. SYMB.	F.L. AMPS	WT.	"C" DIM.	FOOT NOTES
Single Phase												
1/2	3450	115/230	56CZ	B587	Century	√	\$616	F1	6.6/3.3	11.30		
		208-230	56HCZ	B584	Century	√	\$624	F1	2.8-2.7			
3/4	3450	208-230	56HCZ	B582	Century	√	\$610	F1	4.0-3.8	12.20		
		208-230	56HCZ	B585	Century	√	\$654	F1	4.0-3.8			
		208-230	56HCZ	B592	Century	√	\$795	F1	4.0-3.8			
1	3450	208-230	56HCZ	B583	Century	√	\$687	F1	4.8-4.5	12.20		
		208-230	56HCZ	B586	Century	√	\$734	F1	4.8-4.5			
Three Phase												
1/2	3450	208-230/460	56HCZ	B596	Century	√	\$657	F1	1.9-1.8/0.9	11.93		
3/4	3450	208-230/460	56HCZ	B597	Century	√	\$885	F1	2.5-2.4/1.2	13.40		
		208-230	56HCZ	B598	Century	√	\$698	F1	2.5-2.4			
1	3450	208-230/460	56HCZ	B595	Century	√	\$745	F1	3.3-3.2/1.6	12.20		
		208-230/460	56HCZ	B599	Century	√	\$813	F1	3.3-3.2/1.6			

NEMA is a trademark of National Electrical Manufacturers Association. All Rights Reserved.

Prices and specifications are subject to change without notice.

CENTURY® SINGLE PHASE FARM RATED MOTORS

TOTALLY ENCLOSED, FAN COOLED MOTORS

FEATURES:

- Cast aluminum construction
- Rigid base
- Reversible
- Energy Efficient Design

HP	RPM	VOLTS	FRAME	CAT. NO.	MODEL NO.	STOCK	LIST PRICE	MULT. SYMB.	FL. AMPS	WT.	"C" DIM.	FOOT NOTES
7 1/2	3450	230	215T	K314M2	Century®	√	\$3,020	S1	33.0	125	19.12	1, ES
10	1800	230/460	215T	K313M2	Century	√	\$3,046	S1	39.0/19.5	151	19.12	1, ES

CENTURY SURGE PUMP REPLACEMENT MOTORS

ROLLED STEEL CONSTRUCTION, OPEN DRIP PROOF MOTORS

FEATURES:

- Capacitor start, capacitor run design
- Double shield ball bearings
- Manual overload protector
- Class F insulation

HP	RPM	VOLTS	FRAME	CAT. NO.	MODEL NO.	STOCK	LIST PRICE	MULT. SYMB.	FL. AMPS	WT.	"C" DIM.	FOOT NOTES
5 1/2	1200	230	215T	V308M2	Century	√	\$2,814	S1	23.6	136	19.31	1, ES, F2

FARM DUTY / AGRICULTURAL

POWERWASH™ XT WASH DOWN DUTY®, SINGLE PHASE MOTORS

WHITE EPOXY, TOTALLY ENCLOSED MOTORS

FEATURES:

- Encapsulated electronic starting switch is impervious to moisture
- Capacitor start induction run design for high starting torque unless otherwise noted
- Class F insulation
- 1.15 service factor
- Double sealed ball bearings
- 303 stainless steel shaft with spring loaded contact seals in each endshield
- Stainless steel conduit box cover, nameplate, fan guard (TEFC) and hardware
- Cast oversized conduit box with high temperature nitrile gaskets and threaded entrance
- Plugged drain holes in each endshield for all angle mounting
- Internal corrosion resistant coatings on frame, base, endshields, rotor and stator
- USDA-approved, white epoxy RUST-OLEUM® paint
- UL recognized, CSA certified and CE mark



IP55

RIGID BASE

HP	RPM	VOLTS	FRAME	CAT. NO.	MODEL NO.	STOCK	LIST PRICE	MULT. SYMB.	FL. AMPS	WT.	"C" DIM.	FOOT NOTES
1/2	1800	115/208-230	56	N680	056C17W5336	√	\$816	F3	8.8/4.4-4.4	30	10.81	13
3/4	1800	115/208-230	56	N681	056C17W5337	√	\$958	F3	10.8/5.4-5.4	25	11.31	13
1	1800	115/208-230	56	N682	056C17W5338	√	\$1,087	F3	12.8/6.4-6.4	34	11.81	13
	1800	115/208-230	143T	N685	143TCWR17031	√	\$1,033	F3	12.8/6.4-6.4	78	12.43	13
1 1/2	1800	115/208-230	145T	N683	145TCWR5326	√	\$1,396	F3	19.0/9.5-9.5	50	13.75	13
2	1800	115/208-230	182T	N684A	182TCWW7026	√	\$2,029	F3	25.2/12.6-2.6	65	13.46	13

C-FACE FOOTLESS

HP	RPM	VOLTS	FRAME	CAT. NO.	MODEL NO.	STOCK	LIST PRICE	MULT. SYMB.	FL. AMPS	WT.	"C" DIM.	FOOT NOTES
1/3	3600	115/208-230	56C	N530	056C34W5301	√	\$669	F3	5.2/2.8-2.6	28	10.69	13
	1800	115/208-230	56C	N531	056C17W5326	√	\$727	F3	6.4/3.2-3.2	23	10.69	13
1/2	3600	115/208-230	56C	N532	056C34W5302	√	\$727	F3	7.6/4.0-3.8	27	10.69	13
	1800	115/208-230	56C	N523	056C17W5327	√	\$746	F3	8.8/4.4-4.4	26	11.19	13
3/4	3600	115/208-230	56C	N524	056C34W5303	√	\$732	F3	10.0/5.2-5.0	30	11.69	13
	1800	115/208-230	56C	N525	056C17W5328	√	\$862	F3	10.8/5.4-5.4	31	11.69	13
1	3600	115/208-230	56C	N526	056C34W5304	√	\$735	F3	12.0/6.2-6.0	32	12.19	13
	1800	115/208-230	56C	N527	056C17W5329	√	\$977	F3	12.8/6.4-6.4	33	12.19	13
1 1/2	3600	115/208-230	56C	N528	056C34W5305	√	\$1,084	F3	17.0/8.5-8.5	50	12.69	13
	1800	115/208-230	56C	N529	056C17W5330	√	\$1,251	F3	19.0/9.5-9.5	23	13.69	13

C-FACE FOOTED (RIGID BASE)

HP	RPM	VOLTS	FRAME	CAT. NO.	MODEL NO.	STOCK	LIST PRICE	MULT. SYMB.	FL. AMPS	WT.	"C" DIM.	FOOT NOTES
1/3	3600	115/208-230	56C	N556	056C34W5306	√	\$674	F3	5.2/2.7-2.6	50	10.41	13
	1800	115/208-230	56C	N557	056C17W5331	√	\$732	F3	6.4/3.2-3.2	25	10.69	13
1/2	3600	115/208-230	56C	N558	056C34W5307	√	\$732	F3	7.6/4.0-3.8	26	10.69	13
	1800	115/208-230	56C	N559	056C17W5332	√	\$775	F3	8.8/4.4-4.4	27	11.19	13
3/4	3600	115/208-230	56C	N540	056C34W5308	√	\$738	F3	10.0/5.2-5.0	31	11.69	13
	1800	115/208-230	56C	N541	056C17W5333	√	\$857	F3	10.8/5.4-5.4	31	11.69	13
1	3600	115/208-230	56C	N542	056C34W5309	√	\$741	F3	12.0/6.2-6.0	33	12.19	13
	1800	115/208-230	56C	N543	056C17W5334	√	\$985	F3	12.8/6.4-6.4	34	12.19	13
1 1/2	3600	115/208-230	56C	N544	056C34W5310	√	\$1,087	F3	17.0/8.5-8.5	36	12.69	13
	1800	115/208-230	56HC	N545	056C17W5335	√	\$1,257	F3	19.0/9.5-9.5	43	13.69	5, 13
2	3600	115/208-230	56HC	N546	056C34W99003	√	\$1,312	F3	20.0/11.4-10.0	55	12.87	5, 13

Rust-oleum is believed to be the trademark or trade name of Rust-oleum Corporation and is not owned or controlled by Regal Beloit Corporation.

Prices and specifications are subject to change without notice.

POWERWASH™ XT WASH DOWN DUTY®, THREE PHASE MOTORS

WHITE EPOXY, TOTALLY ENCLOSED MOTORS

FEATURES:

- 10:1 variable torque, constant torque speed range as listed below
- MAX GUARD® class F insulation system
- 1.15 service factor on sinewave, 1.0 service factor on IGBT power
- Double sealed ball bearings
- 303 stainless steel shaft with spring loaded contact seals in each endshield (Drive end only on TENV motors)
- Stainless steel conduit box cover, nameplate, fan guard (TEFC only) and hardware
- Cast oversized conduit box with high temperature nitrile gaskets and threaded entrance
- Plugged drain holes in each endshield for all angle mounting
- Internal corrosion resistant coatings on frame, base, endshields, rotor and stator
- USDA-approved, white epoxy RUST-OLEUM® paint
- UL recognized, CSA certified and CE mark



IP55



RIGID BASE

HP	RPM	VOLTS	FRAME	CAT. NO.	MODEL NO.	STOCK	CT SPEED RANGE*	LIST PRICE	MULT. SYMB.	NOM. EFF.	FL. AMPS	WT.	"C" DIM.	FOOT NOTES
1/3	1800	208-230/460	56	E286	5KS49HN4595	√	10:1	\$717	F3	75.5	1.2-1.6/8	24	9.68	ES, N, 20, 50
1/2	1800	208-230/460	56	N322	056T17W5344	√	10:1	\$736	F3	74.0	2.0-2.0/1.0	25	10.81	V
3/4	1800	208-230/460	56	N320	056T17W5340	√	10:1	\$784	F3	77.0	2.8-2.8/1.4	25	10.81	V
1	1800	208-230/460	56	N326	056T17W99025	√	10:1	\$1,014	F3	85.5	3.2/1.6	37	12.25	V
	1800	230/460	143T	N310A	143TTWR16028	√	10:1	\$1,016	F3	85.5	3.2/1.6	39	12.75	V
	1200	230/460	145T	N323	145TTWR6076	√	10:1	\$1,409	F3	82.5	4.2/2.1	45	13.25	V
1 1/2	1800	230/460	145T	N321A	145TTWR6029	√	10:1	\$1,050	F3	86.5	4.4/2.2	51	12.75	V
2	1800	230/460	145T	N312A	145TTWR6027	√	10:1	\$1,305	F3	86.5	5.6/2.8	46	13.75	V
	3600	230/460	145T	N324	145TTWR16002	√	10:1	\$1,589	F3	86.5	8.0/4.0	52	13.68	V
3	1800	230/460	182T	N314B	182TTWW6027	√	10:1	\$1,726	F3	89.5	8.2/4.1	69	13.96	V, 13
	3600	230/460	184T	N315A	184TTWW6004	√	10:1	\$2,172	F3	88.5	12.0/6.0	75	14.46	V, 13
5	1800	230/460	184T	N316B	184TTWW6027	√	10:1	\$1,973	F3	89.5	13.0/6.5	85	14.96	V, 13
	3600	230/460	184T	N317A	184TTWW6003	√	10:1	\$2,741	F3	89.5	16.8/8.4	87	15.96	V, 13
7 1/2	3600	230/460	213T	N325	213TTWW16002	√	10:1	\$3,060	F3	89.5	17.6/8.8	87	16.59	V, 68
	1800	230/460	213T	N318A	213TTWR6027	√	10:1	\$2,462	F3	91.7	20.4/10.2	131	17.21	d, V
	1800	208-230/460	213T	N318B	213TTWRD6027	√	10:1	\$2,462	F3	91.7	20.8-19.6/9.8	137	18.04	V
	1800	230/460	215T	N319A	215TTWR6027	√	10:1	\$2,947	F3	91.7	26.0/13.0	165	18.71	d, V
10	1800	230/460	215T	N319B	215TTWRD6027	√	10:1	\$2,947	F3	91.7	14.0-26.4/13.2	165	19.54	V

Catalog numbers (Cat No.) highlighted in bold blue are premium efficient.

* Requires nameplate modification.

WASHDOWN

Rust-oleum is believed to be the trademark or trade name of Rust-oleum Corporation and is not owned or controlled by Regal Beloit Corporation.

Prices and specifications are subject to change without notice.

POWERWASH™ XT WASH DOWN DUTY®, THREE PHASE MOTORS

WHITE EPOXY, TOTALLY ENCLOSED MOTORS



C-FACE FOOTLESS

Same features as shown on page 122

HP	RPM	VOLTS	FRAME	CAT. NO.	MODEL NO.	STOCK	CT SPEED RANGE*	LIST PRICE	MULT. SYMB.	NOM. EFF.	FL. AMPS	WT.	"C" DIM.	FOOT NOTES
1/4	1800	208-230/460	56C	N640	056T17V5326	√	1000:1	\$695	F3	68.0	1.1-1.1/.55	21	9.56	N
1/3	3600	208-230/460	56C	N665	056T34V99001	√	1000:1	\$606	F3	77.0	1.1-1.1/.55	19	10.06	N
	1800	208-230/460	56C	N641	056T17V5327	√	1000:1	\$738	F3	72.0	1.3-1.3/.65	21	9.56	N
	1800	208-230/460	56C	N666	056T17W99003	√	10:1	\$738	F3	68.0	1.7-1.7/.85	21	10.69	V
1/2	3600	208-230/460	56C	N667	056T34V99002	√	1000:1	\$712	F3	82.5	1.7-1.6/.80	22	10.06	N
	1800	208-230/460	56C	N642	056T17V5328	√	1000:1	\$762	F3	78.5	1.8-1.8/.9	25	10.06	N
	1800	208-230/460	56C	N668	056T17W99006	√	10:1	\$762	F3	74.0	2.7-2.8/1.4	25	11.19	V
3/4	3600	208-230/460	56C	N643	056T34V5301	√	1000:1	\$768	F3	84.0	2.6-2.4/1.2	50	11.06	N
	1800	208-230/460	56C	N644	056T17V5329	√	1000:1	\$881	F3	80.0	2.5-2.5/1.25	30	10.56	N
	1800	208-230/460	56C	N669	056T17W99002	√	10:1	\$881	F3	77.0	2.7-2.8/1.4	28	11.69	V
1	3600	208-230/460	56C	N645	056T34V5302	√	1000:1	\$897	F3	78.5	2.8-2.6/1.3	34	11.56	N
	1800	230/460	56C	N646A	056T17W99015	√	1000:1	\$985	F3	85.5	3.1/1.55	39	12.87	V
	1800	230/460	143TC	N647A	143TTWR16026	√	10:1	\$985	F3	85.5	3.2/1.6	39	12.72	V
1 1/2	3600	208-230/460	56C	N648	056T34V5303	√	1000:1	\$951	F3	84.0	4.2-3.8/1.9	42	12.56	N
	1800	208-230/460	56C	N649	056T17V5331	√	1000:1	\$958	F3	84.0	4.2-4.2/2.1	46	13.06	d, N
	1800	230/460	56C	N649A	056T17W99018	√	10:1	\$1,028	F3	86.5	4.3/2.15	51	13.37	V
	1800	230/460	145TC	N650A	143TTWR16030	√	10:1	\$1,028	F3	86.5	4.8/2.4	51	13.22	V
2	3600	230/460	56C	N651A	056T34W99020	√	10:1	\$1,203	F3	85.5	4.8/2.4	51	13.37	V
	3600	230/460	145TC	N652A	145TTWR16XXX	√	10:1	\$1,203	F3	85.5	4.8/2.4	51	16.62	V
	1800	230/460	56C	N653A	056T17W99022	√	10:1	\$1,227	F3	86.5	5.8/2.9	45	13.87	V
	1800	230/460	145TC	N654B	145TTWR16028	√	10:1	\$1,227	F3	86.5	5.8/2.9	47	13.72	V
3	3600	230/460	56C	N662A	056T34W99016	√	10:1	\$1,573	F3	86.5	8.0/4.0	56	13.87	V
	3600	208-230/460	145TC	N655A	145TTWR4301	√	10:1	\$1,573	F3	85.5	8.4-7.6/3.8	48	13.75	d, V
	3600	230/460	145TC	N655B	145TTWR16005	√	10:1	\$1,573	F3	86.5	8.0/4.0	56	13.47	V
	1800	208-230/460	182TC	N656B	182TTWW4028	√	10:1	\$1,573	F3	87.5	8.4-7.6/3.8	81	14.47	d, V
	1800	230/460	182TC	N656C	182TTWW16026	√	10:1	\$1,743	F3	89.5	7.8/3.9	79	14.47	V
5	3600	230/460	184TC	N657B	184TTWW4002	√	10:1	\$1,994	F3	87.5	12.0/6.0	75	14.47	d, V
	3600	230/460	184TC	N657C	184TTWW16004	√	10:1	\$2,073	F3	88.5	12.0/6.0	81	14.97	V
	1800	230/460	184TC	N658C	184TTWW16026	√	10:1	\$1,925	F3	89.5	12.6/6.3	108	14.97	V
7 1/2	3600	230/460	213TC	N659A	213TTWR4001	√	10:1	\$2,472	F3	88.5	16.8/8.4	102	17.47	d, V
	3600	230/460	213TC	N659B	213TTWWD16003	√	10:1	\$2,780	F3	89.5	18.6/9.3	110	18.77	V
	1800	208-230/460	213TC	N660	213TTWR7026	√	10:1	\$2,117	F3	89.5	24.0-22.0/11.0	125	17.71	d, V
	1800	230/460	213TC	N660A	213TTWWD16028	√	10:1	\$2,287	F3	91.7	19.6/9.8	130	18.77	V
10	3600	230/460	215TC	N663	215TTWW16002	√	10:1	\$3,184	F3	91.7	23.6/11.8	170	21.83	V
	1800	230/460	215TC	N661A	215TTWWD16027	√	10:1	\$2,690	F3	91.7	26.4/13.2	174	20.27	V
15	3600	230/460	215TC	N664	215TTWW14008	√	10:1	\$3,267	F3	90.2	36.0/18.0	140	20.57	d, V
	3600	230/460	215TC	N664A	215TTWWD16006	√	10:1	\$3,631	F3	91.0	35.0/17.6	152	20.96	V

Catalog numbers (Cat No.) highlighted in bold blue are premium efficient.

* Requires nameplate modification.

Continued on next page.

POWERWASH™ XT WASH DOWN DUTY®, THREE PHASE MOTORS

WHITE EPOXY, TOTALLY ENCLOSED MOTORS



Same features as shown on page122

C-FACE FOOTED (RIGID BASE)

HP	RPM	VOLTS	FRAME	CAT. NO.	MODEL NO.	STOCK	CT SPEED RANGE*	LIST PRICE	MULT. SYMB.	NOM. EFF.	FL. AMPS	WT.	"C" DIM.	FOOT NOTES
1/4	1800	208-230/460	56C	N564	056T17V5332	√	1000:1	\$698	F3	68.0	1.1-1.1/55	24	10.08	13, N
	1800	575	56C	N620A	056T17V15501	√	1000:1	\$698	F3	68.0	0.44	23	10.06	13, N
1/3	3600	208-230/460	56C	N631	056T34W99002	√	10:1	\$593	F3	77.0	1.1-1.1/55	22	10.08	13, V
	1800	208-230/460	56C	N628	056T17W5334	√	10:1	\$767	F3	68.0	1.7-1.7/85	23	10.69	13, V
	1800	575	56C	N621	056T17W5335	√	10:1	\$767	F3	68.0	0.68	20	10.69	13, V
1/2	3600	208-230/460	56C	N566	056T34V5305	√	1000:1	\$686	F3	76.0	1.7-1.6/8	27	10.58	13, N
	1800	208-230/460	56C	N567	056T17V5336	√	1000:1	\$781	F3	78.5	1.8-1.8/9	26	10.06	13, N
	1800	208-230/460	56C	N632	056T17W99005	√	10:1	\$781	F3	74.0	1.9-2.0/1.0	22	11.19	13, V
	1800	575	56C	N622	056T17V5337	√	1000:1	\$781	F3	78.5	0.8	25	10.08	13, N
	1200	208-230/460	56C	N568	056T11V5376	√	1000:1	\$974	F3	77.0	2.3-2.3/1.15	23	11.56	13, N
3/4	3600	208-230/460	56C	N569	056T34V5306	√	1000:1	\$765	F3	75.5	2.6-2.4/1.2	50	11.08	13, N
	1800	208-230/460	56C	N599	056T17V5338	√	1000:1	\$904	F3	80.0	2.5-2.5/1.25	31	10.56	13, N
	1800	208-230/460	56C	N633	056T17W99004	√	10:1	\$904	F3	77.0	2.9-2.8/1.4	26	11.19	13, V
	1800	575	56C	N623	056T17W5339	√	10:1	\$904	F3	77.0	1.1	31	11.19	13, V
	1200	208-230/460	56C	N600	056T11V5377	√	1000:1	\$1,060	F3	78.5	3.0-3.0/1.5	25	13.06	13, N
1	3600	208-230/460	56C	N601	056T34V5307	√	1000:1	\$894	F3	78.5	2.8-2.6/1.3	35	11.56	13, N
	1800	230/460	56C	N602A	056T17W99016	√	10:1	\$1,101	F3	85.5	3.1/1.6	42	12.62	13, V
	1800	575	56C	N627	056T17W5341	√	10:1	\$942	F3	77.0	1.5	29	11.69	d, V
	1800	575	56C	N627A	056T17W99035	√	10:1	\$1,101	F3	85.5	1.3	42	12.41	13, V
	1800	230/460	143TC	N626A	143TTWR6028	√	10:1	\$1,101	F3	85.5	3.2/1.6	42	12.75	13, V
	1200	208-230/460	56HC	N604	056T11W5377	√	10:1	\$1,136	F3	78.5	4.0-4.0/2.0	36	13.06	d, 13, V
	1200	230/460	56HC	N604A	056T11W99003	√	10:1	\$1,308	F3	82.5	3.8/1.9	42	13.16	13, V
1 1/2	3600	208-230/460	56C	N605	056T34V5308	√	1000:1	\$988	F3	84.0	4.2-3.8/1.9	43	12.56	13, N
	1800	230/460	56C	N606A	056T17W99044	√	10:1	\$1,187	F3	86.5	4.8/2.4	47	13.37	13, V
	1800	208-230/460	145TC	N607	145TTVR5326	√	1000:1	\$983	F3	84.0	4.2-4.2/2.1	48	13.12	d, N, 13
	1800	230/406	145TC	N607A	145TTWR16026	√	10:1	\$1,187	F3	86.5	4.3/2.1	47	13.22	13, V
	1800	575	145TC	N629	145TTVR5030	√	1000:1	\$1,235	F3	84.0	1.8	42	13.12	d, N, 13
	1800	575	145TC	N629A	145TTWR16029	√	10:1	\$1,187	F3	86.5	1.9	47	13.22	13, V
	1200	230/460	56HC	N608A	182TTWW16087	√	10:1	\$1,677	F3	87.5	5.2/2.6	80	14.97	V
2	3600	230/460	56HC	N609A	056T34W99022	√	10:1	\$1,191	F3	85.5	4.8/2.4	49	13.62	5, 17, V
	3600	230/460	145TC	N610A	145TTWR16003	√	10:1	\$1,191	F3	85.5	4.8/2.4	49	13.22	13, V
	1800	230/460	56C	N611A	056T17W99020	√	10:1	\$1,358	F3	86.5	6.0/3.0	49	13.66	13, V
	1800	575	145TC	N630	145TTWR6033	√	10:1	\$1,358	F3	86.5	2.3	46	13.75	13, V
	1800	230/460	145TC	N612A	145TTWR6026	√	10:1	\$1,358	F3	86.5	5.6/2.8	46	13.75	13, V
3	3600	230/460	145TC	N613A	145TTWR6001	√	10:1	\$1,795	F3	86.5	8.0/4.0	46	13.75	13, V
	3600	230/460	182TC	N634	182TTWW16002	√	10:1	\$2,131	F3	86.5	7.6/3.8	80	14.97	13, 19, V
	1800	230/460	182TC	N614B	182TTWW6026	√	10:1	\$2,000	F3	89.5	7.8/3.9	80	14.47	V
5	3600	230/460	184TC	N615B	184TTWW6001	√	10:1	\$2,502	F3	88.5	12.0/6.0	79	14.47	V
	1800	230/460	184TC	N616B	184TTWW6026	√	10:1	\$2,258	F3	88.5	12.8/6.4	84	14.97	V
7 1/2	3600	230/460	213TC	N617A	213TTWR6002	√	10:1	\$3,108	F3	89.5	17.8/8.9	140	17.47	d, V
	3600	208-230/460	213TC	N617B	213TTWRD6002	√	10:1	\$3,108	F3	89.5	19.7-18.6/9.3	145	18.77	V
	3600	230/460	184TC	N635	184TTWW16002	√	10:1	\$2,877	F3	89.5	17.6/8.8	94	15.97	V
	1800	230/460	213TC	N618A	213TTWR6026	√	10:1	\$2,864	F3	91.7	21.4/10.7	135	17.71	d, V
	1800	208-230/460	213TC	N618B	213TTWRD6026	√	10:1	\$2,864	F3	91.7	20.8-19.6/9.8	150	18.77	V
10	3600	230/460	215TC	N637	215TTWW16003	√	10:1	\$3,570	F3	90.2	23.6/11.8	129	20.57	d, V
	3600	230/460	215TC	N637A	215TTWW16003	√	10:1	\$3,570	F3	90.2	23.6/11.8	143	20.27	V
	1800	230/460	215TC	N619A	215TTWR6026	√	10:1	\$3,256	F3	91.7	26.6/13.3	145	18.71	V
	1800	208-230/460	215TC	N619B	215TTWRD6026	√	10:1	\$3,256	F3	91.7	14.0-26.4/13.2	162	20.27	V

Catalog numbers (Cat No.) highlighted in bold blue are premium efficient.

* Requires nameplate modification.

WASHDOWN

POWERWASH™ XT WASH DOWN DUTY®, THREE PHASE MOTORS

WHITE EPOXY, TOTALLY ENCLOSED MOTORS

CLOSE COUPLED PUMP, JM, RIGID BASE

Same features as shown on page 122

HP	RPM	VOLTS	FRAME	CAT. NO.	MODEL NO.	STOCK	CT SPEED RANGE*	LIST PRICE	MULT. SYMB.	NOM. EFF.	FL. AMPS	WT.	"C" DIM.	FOOT NOTES
1	1800	208-230/460	143JM	N201	143TTWR14032	✓	10:1	\$1,195	F3	82.5	3.2-3.1/1.55	41	16.25	d
	1800	230/460	143JM	N201A	143TTWR16029	✓	10:1	\$1,291	F3	85.5	3.2/1.6	45	15.43	
1 1/2	3600	208-230/460	143JM	N202	143TTWR14002	✓	10:1	\$1,234	F3	82.5	4.4-4.0/2.0	33	16.25	d
	3600	230/460	143JM	N202A	—	✓	10:1	\$1,234	F3	84.0	4.0/2.0	38	15.93	
	1800	208-230/460	145JM	N203	143TTWR14031	✓	10:1	\$1,262	F3	84.0	4.5-4.4/2.2	47	16.25	d
	1800	230/460	145JM	N203A	143TTWR16027	✓	10:1	\$1,364	F3	86.5	4.8/2.4	52	15.93	
2	3600	208-230/460	145JM	N204	145TTWR14003	✓	10:1	\$1,285	F3	84.0	5.6-5.2/2.6	50	16.25	d
	3600	230/460	145JM	N204A	145TTWR16007	✓	10:1	\$1,387	F3	85.5	4.8/2.4	55	15.93	
	1800	208-230/460	145JM	N205	145TTWR14031	✓	10:1	\$1,313	F3	84.0	6.0-5.6/2.8	49	16.75	d
	1800	230/460	145JM	N205A	145TTWR16030	✓	10:1	\$1,418	F3	86.5	5.8/2.9	54	16.43	
3	3600	208-230/460	145JM	N206	145TTWR14004	✓	10:1	\$1,333	F3	85.5	8.4-7.6/3.8	54	16.75	d
	3600	230/460	145JM	N206A	145TTWR16006	✓	10:1	\$1,441	F3	86.5	8.0/4.0	54	16.43	
	1800	208-230/460	182JM	N207	182TTWW14031	✓	10:1	\$2,188	F3	87.5	8.0-8.6/4.3	79	16.75	d, 13
	1800	230/460	182JM	N207A	182TTWW16027	✓	10:1	\$2,364	F3	89.5	7.8/3.9	84	16.13	13
5	3600	208-230/460	184JM	N208	184TTWW14005	✓	10:1	\$2,395	F3	87.5	13.0-12.0/6.0	81	16.75	d, 13
	3600	230/460	184JM	N208A	184TTWW16005	✓	10:1	\$2,588	F3	88.5	12.0/6.0	86	16.63	13
	1800	230/460	184JM	N209A	184TTWW16027	✓	10:1	\$2,456	F3	89.5	12.6/6.3	84	16.63	13
	3600	208-230/460	184JM	N210A	184TTWW16006	✓	10:1	\$2,410	F3	90.1	17.6/8.8	120	17.13	13
7 1/2	1800	208-230/460	213JM	N211	213TTWW14031	✓	10:1	\$3,844	F3	89.5	24.0-22.0/11.0	135	19.50	d
	1800	230/460	213JM	N211A	213TTWW16026	✓	10:1	\$4,152	F3	91.7	19.6/9.8	145	21.40	
10	3600	208-230/460	215JM	N212	215TTWW14009	✓	10:1	\$3,737	F3	89.5	27.0-24.0/12.0	142	22.20	d
	3600	230/460	215JM	N212A	215TTWW16005	✓	10:1	\$4,037	F3	90.2	23.6/11.8	152	21.40	
	1800	208-230/460	215JM	N213	215TTWW14031	✓	10:1	\$3,669	F3	89.5	29.0-28.0/14.0	150	21.70	d
	1800	230/460	215JM	N213A	215TTWW16026	✓	10:1	\$3,964	F3	91.7	26.4/13.2	160	21.40	
15	3600	208-230/460	215JM	N214	215TTWW14007	✓	10:1	\$4,329	F3	90.2	37.0-36.0/18.0	160	22.20	d
	3600	230/460	215JM	N214A	215TTWW16007	✓	10:1	\$4,676	F3	91.0	35/17.6	165	21.40	

CENTRIFUGAL PUMP (JET PUMP), C-FACE FOOTLESS, 56J

HP	RPM	VOLTS	FRAME	CAT. NO.	MODEL NO.	STOCK	CT SPEED RANGE*	LIST PRICE	MULT. SYMB.	NOM. EFF.	FL. AMPS	WT.	"C" DIM.	FOOT NOTES
3/4	3600	208-230/460	56J	N230	056T34W99007	✓	10:1	\$834	F3	75.5	2.5-2.4/1.2	23	10.81	
1	3600	208-230/460	56J	N232	056T34W99010	✓	10:1	\$915	F3	77.0	3.4-3.2/1.6	35	10.81	
1 1/2	3600	208-230/460	56J	N234	056T34W99011	✓	10:1	\$987	F3	81.5	4.4-4.2/2.1	42	11.81	d
	3600	230/460	56J	N234A	056T34W99018	✓	10:1	\$1,066	F3	84.0	4.0/2.0	47	12.87	
2	3600	208-230/460	56J	N236	056T34W99008	✓	10:1	\$1,055	F3	82.5	5.8-5.6/2.8	47	12.31	d
	3600	230/460	56J	N236A	056T34W99019	✓	10:1	\$1,235	F3	85.5	4.8/2.4	52	13.87	
3	3600	230/460	56J	N238A	056T34W99024	✓	10:1	\$1,312	F3	86.5	8.0/4.0	53	14.37	

CENTRIFUGAL PUMP (JET PUMP), C-FACE FOOTED (RIGID BASE), 56J

HP	RPM	VOLTS	FRAME	CAT. NO.	MODEL NO.	STOCK	CT SPEED RANGE*	LIST PRICE	MULT. SYMB.	NOM. EFF.	FL. AMPS	WT.	"C" DIM.	FOOT NOTES
3/4	3600	208-230/460	56J	N220	056T34W99003	✓	10:1	\$883	F3	75.5	2.5-2.4/1.2	24	10.81	
1	3600	208-230/460	56J	N222	056T34W99004	✓	10:1	\$955	F3	77.0	3.4-3.2/1.6	36	10.81	
1 1/2	3600	208-230/460	56J	N224	056T34W99005	✓	10:1	\$1,007	F3	81.5	4.4-4.2/2.1	43	11.81	d
	3600	230/460	56J	N224A	056T34W99021	✓	10:1	\$1,089	F3	84.0	4.0/2.0	31	12.87	
2	3600	208-230/460	56J	N226	056T34W99006	✓	10:1	\$1,098	F3	82.5	5.8-5.6/2.8	48	12.31	d
	3600	230/460	56J	N226A	056T34W99023	✓	10:1	\$1,286	F3	85.5	4.8/2.4	53	13.87	
3	3600	208-230/460	56J	N228	056T34W99009	✓	10:1	\$1,171	F3	84.0	8.4-7.6/3.8	50	13.25	d
	3600	230/460	56J	N228A	056T34W99017	✓	10:1	\$1,348	F3	86.5	8.0/4.0	55	14.37	

Catalog numbers (Cat No.) highlighted in bold blue are premium efficient.

* Requires nameplate modification.

Continued on next page.

POWERWASH™ XT WASH DOWN DUTY®, THREE PHASE MOTORS

WHITE EPOXY, TOTALLY ENCLOSED MOTORS

BRAKEMOTOR C-FACE FOOTLESS

HP	RPM	VOLTS	FRAME	CAT. NO.	MODEL NO.	STOCK	CT SPEED RANGE*	LIST PRICE	MULT. SYMB.	NOM. EFF.	FL. AMPS	WT.	"C" DIM.	BRAKE RATING (LB/FT)	FOOT NOTES
1/3	1800	208-230/460	56C	N371	056T17V99003	√	1000:1	\$1,191	F3	72.0	1.4-1.3/65	39	14.00	3.00	N
1/2	1800	208-230/460	56C	N373	056T17V99004	√	1000:1	\$1,221	F3	78.5	2.0-1.8/9	41	14.50	3.00	N
3/4	1800	208-230/460	56C	N375	056T17V99002	√	1000:1	\$1,452	F3	80.0	2.7-2.5/1.25	43	15.00	6.00	N
1	1800	208-230/460	56C	N377	056T17V99009	√	1000:1	\$1,505	F3	80.0	3.3-3.2/1.6	45	15.50	6.00	d, N
	1800	230/460	56J	N383	056T17W99046	√	10:1	\$1,624	F3	85.5	3.2/1.6	50	17.50	6.00	
	1800	208-230/460	143TC	N378	143TTVR5330	√	1000:1	\$1,505	F3	80.0	3.3-3.2/1.6	46	15.56	6.00	d, N
	1800	230/460	143TC	N384	143TTWR16031	√	10:1	\$1,624	F3	85.5	3.2/1.6	51	18.00	6.00	
1 1/2	1800	208-230/460	145TC	N380A	145TTWR16031	√	10:1	\$2,247	F3	86.5	4.8/2.4	49	18.50	10.00	V, 5
2	1800	208-230/460	145TC	N382	145TTWR17032	√	10:1	\$2,144	F3	81.5	6.2-6.2/3.1	61	18.51	10.00	d, V, 5
	1800	230/460	145TC	N382A	145TTWR16032	√	10:1	\$2,313	F3	86.5	5.8/2.9	66	19.00	10.00	V

BRAKEMOTOR C-FACE FOOTED (RIGID BASE)

HP	RPM	VOLTS	FRAME	CAT. NO.	MODEL NO.	STOCK	CT SPEED RANGE*	LIST PRICE	MULT. SYMB.	NOM. EFF.	FL. AMPS	WT.	"C" DIM.	BRAKE RATING (LB/FT)	FOOT NOTES
1/3	1800	208-230/460	56C	N351	056T17V99006	√	1000:1	\$1,234	F3	72.0	1.4-1.3/65	40	14.00	3.00	N
1/2	1800	208-230/460	56C	N353	056T17V99007	√	1000:1	\$1,257	F3	78.5	2.0-1.8/9	42	14.50	3.00	N
3/4	1800	208-230/460	56C	N355	056T17V99008	√	1000:1	\$1,493	F3	80.0	2.7-2.5/1.25	44	15.00	6.00	N
1	1800	230/460	56C	N363	056T17W99047	√	10:1	\$1,543	F3	86.5	3.2/1.6	48	17.50	6.00	
	1800	208-230/460	143TC	N358A	143TTVR16026	√	1000:1	\$1,543	F3	86.5	3.0-2.8/1.4	49	17.06	6.00	N
1 1/2	1800	208-230/460	145TC	N360	145TTWR14032	√	10:1	\$2,139	F3	84.0	4.5-4.4/2.2	50	19.01	10.00	d, V, 5
	1800	230/460	145TC	N360A	145TTWR16033	√	10:1	\$2,308	F3	86.5	4.8/2.4	55	18.50	10.00	V
2	1800	208-230/460	145TC	N362	145TTWR14033	√	10:1	\$2,217	F3	84.0	6-5.6/2.8	62	19.01	10.00	d, V, 5
	1800	230/460	145TC	N362A	145TTWR16034	√	10:1	\$2,392	F3	86.5	5.8/2.9	67	19.00	10.00	V

Catalog numbers (Cat No.) highlighted in bold blue are premium efficient.

* Requires nameplate modification.

POWERWASH™ SXT WASH DOWN DUTY®, SINGLE PHASE MOTORS

ALL STAINLESS STEEL, TOTALLY ENCLOSED MOTORS

FEATURES:

- Capacitor start induction run design for high starting torque unless otherwise noted
- 1.15 service factor on sinewave
- Double sealed ball bearings
- 303 stainless steel shaft with spring loaded contact seals in each end
- 300 series stainless steel external construction: frame, endshields, conduit box, fan guard, mounting base and hardware for superior corrosion resistance
- Internal corrosion resistant coatings on rotor and heavy polyester varnish on the stator
- 100% paint-free constructions
- One way condensation drains in each endshield and conduit box for all angle mounting
- Nitrile Buna - N gaskets and seals on conduit box, through bolts and endshields
- Nameplate information laser etched on frame
- UL recognized, CSA certified and CE mark



C-FACE FOOTED (RIGID BASE)

HP	RPM	VOLTS	FRAME	CAT. NO.	MODEL NO.	STOCK	LIST PRICE	MULT. SYMB.	F.L. AMPS	WT.	"C" DIM.	FOOT NOTES
1/2	3600	115/208-230	56C	N340	056C34WD5301	√	\$751	F3	7.4/3.7	29.5	11.10	
	1800	115/208-230	56C	N341	056C17WD5327	√	\$846	F3	8.2/4.1	31.5	11.10	
3/4	3600	115/208-230	56C	N342	056C34WD5302	√	\$826	F3	9.2/4.6	31.5	11.80	
	1800	115/208-230	56C	N343	056C17WD5328	√	\$977	F3	9.8/4.9	39.0	11.80	
1	3600	115/208-230	56C	N344	056C34WD5303	√	\$971	F3	12.4/6.2	39.0	12.30	
	1800	115/208-230	56C	N345	056C17WD5329	√	\$1,018	F3	13.6/6.8	42.5	12.30	
1 1/2	3600	115/208-230	56C	N346	056C34WD5304	√	\$1,068	F3	16.4/8.5-8.2	42.5	13.20	
	1800	115/208-230	56C	N347	056C17WD5330	√	\$1,065	F3	15.8/7.9	52.5	13.20	
2	3600	115/208-230	145TC	N348	145TBWD5305	√	\$1,379	F3	19.0/9.5	64.5	14.20	
	1800	115/208-230	145TC	N349	145TBWD5335	√	\$1,350	F3	16.4/8.2	64.5	14.20	

POWERWASH™ SXT WASH DOWN DUTY®, THREE PHASE MOTORS

ALL STAINLESS STEEL, TOTALLY ENCLOSED MOTORS

FEATURES:

- Suitable for use on VFD 10:1 variable torque, 10:1 (TEFC) or 1000:1 (TENV) constant torque
- MAX GUARD® Class F insulation system
- 1.15 service factor on sinewave, 1.0 service factor on IGBT power
- Double sealed ball bearings
- 303 stainless steel shaft with spring loaded contact seals in each end. (Drive end only on TENV)
- 300 series stainless steel external construction: frame, endshields, conduit box, mounting base and hardware for superior corrosion resistance
- Internal corrosion resistant coatings on rotor and heavy polyester varnish on the stator
- 100% Paint-free construction
- One way condensation drains in each endshield and conduit box for all angle mounting
- Nitrile Buna - N gaskets and seals on conduit box, through bolts and endshields
- Rated 60/50 hertz, 190/380 volt at next lower horsepower
- Nameplate information laser etched on frame
- UL recognized, CSA certified and CE mark



IP55



C-FACE FOOTLESS

HP	RPM	VOLTS	FRAME	CAT. NO.	MODEL NO.	STOCK	LIST PRICE	MULT. SYMB.	NOM. EFF.	FL. AMPS	WT.	"C" DIM.	FOOT NOTES
1/3	1800	208-230/460	56C	N430	056T17VD5329	✓	\$816	F3	78.5	1.2-1.3/.65	30	9.78	N
1/2	1800	208-230/460	56C	N431	056T17VD5330	✓	\$837	F3	81.5	1.5-1.6/.8	30	9.78	N
	1200	208-230/460	56C	N426	056T11VD5378	✓	\$974	F3	80.0	2.1-2/1	33	9.76	N
3/4	1800	208-230/460	56C	N432	056T17VD5331	✓	\$972	F3	82.5	2.4-2.3/1.15	35	9.78	N
	1200	208-230/460	56C	N427	056T11VD5379	✓	\$1,098	F3	80.0	3-3/1.5	46	9.78	N
1	1800	208-230/460	56C	N428A	056T17VD15332	✓	\$1,163	F3	85.5	3.0/1.5	42	11.00	N
	1800	208-230/460	56C	N433A	056T17WD15330	✓	\$1,163	F3	85.5	3.2-3/1.5	43	13.77	
	1800	208-230/460	143TC	N434B	143TTWD6527	✓	\$1,163	F3	85.5	3.2-3/1.5	43	13.62	
	1200	208-230/460	56C	N429	056T11WD5379	✓	\$1,144	F3	82.5	3.8-3.8/1.9	44	13.10	
1 1/2	1800	208-230/460	56C	N435A	056T17WD15331	✓	\$1,216	F3	86.5	4.8-4.4/2.2	46	13.77	
	1800	208-230/460	145TC	N436A	145TTWD6031	✓	\$1,202	F3	86.5	4.8-4.4/2.2	48	13.62	
2	1800	208-230/460	56C	N437A	056T17WD15332	✓	\$1,387	F3	86.5	5.8-5.4/2.7	52	13.77	
	1800	208-230/460	145TC	N438B	145TTWD6528	✓	\$1,688	F3	86.5	5.8-5.4/2.7	52	13.62	

Catalog numbers (Cat No.) highlighted in bold blue are premium efficient.

Continued on next page

WASHDOWN

POWERWASH™ SXT WASH DOWN DUTY®, THREE PHASE MOTORS

ALL STAINLESS STEEL, TOTALLY ENCLOSED MOTORS

C-FACE FOOTED (RIGID BASE)

Same features as shown on page 128

HP	RPM	VOLTS	FRAME	CAT. NO.	MODEL NO.	STOCK	LIST PRICE	MULT. SYMB.	NOM. EFF.	F.L. AMPS	WT.	"C" DIM.	FOOT NOTES
1/3	3600	208-230/460	56C	N450	056T34VD5301	√	\$735	F3	74.0	1.1-1/5	20	9.78	N
	1800	208-230/460	56C	N410	056T17VD5326	√	\$821	F3	78.5	1.2-1.3/65	30	9.78	N
1/2	3600	208-230/460	56C	N451	056T34VD5302	√	\$751	F3	77.0	1.6-1.5/75	25	9.78	N
	1800	208-230/460	56C	N411	056T17VD5328	√	\$845	F3	81.5	1.5-1.6/8	31	9.78	N
	1800	208-230/460	56C	N494	056T17WD5338	√	\$845	F3	72.0	1.9-2.0/1.0	31	13.77	
	1200	208-230/460	56C	N495	056T11VD5385	√	\$1,034	F3	80.0	2.1-2/1	31	9.78	N
3/4	3600	208-230/460	56C	N452	056T34VD5303	√	\$824	F3	78.5	2.2-2/1	31	9.78	N
	1800	208-230/460	56C	N412	056T17VD5327	√	\$977	F3	82.5	2.4-2.3/1.15	34	9.78	N
	1800	208-230/460	56HC	N496	056T17WD5337	√	\$977	F3	84.0	6-5.6/2.8	32	13.77	
	1200	208-230/460	56C	N497	056T11WD5386	√	\$1,160	F3	80.0	3-3/1.5	46	11.30	N
1	3600	208-230/460	56C	N453	056T34WD5301	√	\$969	F3	80.0	2.9-2.6/1.3	25	13.77	5
	3600	230/460	143TC	N454A	143TTWD6001	√	\$1,218	F3	80.0	2.6/1.3	44	13.62	
	1800	208-230/460	56HC	N419A	056T17WD15336	√	\$1,367	F3	85.5	3.2-3/1.5	46	13.77	
	1800	230/460	143TC	N414A	143TTWD6026	√	\$1,367	F3	85.5	3.0/1.5	45	13.62	
	1200	230/460	56HC	N498	056T11WD5387	√	\$1,293	F3	82.5	3.8/1.9	46	9.78	5
	1200	230/460	145TC	N499	145TTWD6077	√	\$1,627	F3	82.5	3.8/1.9	46	13.20	
1 1/2	3600	208-230/460	56HC	N455A	056T34WD15302	√	\$1,438	F3	84.0	4.2-3.8/1.9	42	13.77	
	3600	230/460	143TC	N456A	143TTWD6002	√	\$1,438	F3	84.0	3.8/1.9	45	13.62	
	1800	208-230/460	56HC	N415A	056T17WD15329	√	\$1,422	F3	86.5	4.8-4.4/2.2	46	13.77	
	1800	230/460	145 C	N416A	145TTWD6028	√	\$1,422	F3	86.5	4.8-4.4/2.2	47	13.62	
2	3600	208-230/460	56HC	N457A	056T34WD15303	√	\$1,163	F3	85.5	5.3-5/2.5	45	13.77	
	3600	230/460	145TC	N458A	145TTWD6001	√	\$1,723	F3	85.5	5.3-5/2.5	47	13.62	
	1800	208-230/460	56HC	N417A	056T17WD15328	√	\$1,688	F3	86.5	5.8-5.4/2.7	52	13.77	
	1800	230/460	145TC	N418A	145TTWD6029	√	\$1,688	F3	86.5	5.8-5.4/2.7	57	13.62	
3	3600	230/460	145TC	N459	145TTWD6030	√	\$1,987	F3	86.5	7.2/3.6	57	14.12	

Catalog numbers (Cat No.) highlighted in bold blue are premium efficient.

POWERWASH™ SXT-PLUS WASH DOWN DUTY®, SINGLE PHASE MOTORS

STAINLESS/BISSC, TOTALLY ENCLOSED MOTORS

FEATURES:

- Encapsulated electronic starting switch is impervious to moisture
- Capacitor start induction run design for high starting torque, except as noted
- 1.15 service factor on sinewave
- Double sealed ball bearings with moisture resistant, high temperature grease
- 303 stainless steel shaft with spring loaded contact seals in each end.
- 300 series stainless steel external construction: frame, endshields, conduit box, fan guard, mounting base and hardware for superior corrosion resistance
- Internal corrosion resistant coatings on rotor and heavy polyester varnish on the stator.
- 100% Paint-free constructions
- Viton® o-rings, shaft seals, and gaskets for superior sealing against chemicals
- Hydrophobic breather in opposite endshield and conduit box equalize air pressure
- Nameplate information laser etched on frame
- BISSC certified for baking industry
- UL recognized, CSA certified and CE mark



IP56

C-FACE FOOTLESS

HP	RPM	VOLTS	FRAME	CAT. NO.	MODEL NO.		LIST PRICE	MULT. SYMB.	FL. AMPS	WT.	"C" DIM.	FOOT NOTES
1/3	1800	115/208-230	56C	N270	056C17V5304	√	\$1,098	F3	5.4/3.0-2.7	35	11.70	N
1/2	1800	115/208-230	56C	N271	056C17V5302	√	\$1,326	F3	6.6/3.5-3.3	38	12.70	N
3/4	1800	115/208-230	56C	N272	056B17V5301	√	\$1,481	F3	7.6/4.2-3.8	42	12.70	N, 1
1	1800	115/208-230	56C	N273	056B17V5302	√	\$1,512	F3	9.0/5.0-4.5	49	13.70	N, 1
1 1/2	1800	115/208-230	145TC	N274	145TBWD5327	√	\$1,613	F3	14.8/7.8-7.4	53	14.87	1
2	1800	115/208-230	145TC	N275	145TBWD5326	√	\$1,981	F3	20.0/10.2-10.0	57	14.87	1

C-FACE FOOTED (RIGID BASE)

HP	RPM	VOLTS	FRAME	CAT. NO.	MODEL NO.		LIST PRICE	MULT. SYMB.	FL. AMPS	WT.	"C" DIM.	FOOT NOTES
1/3	1800	115/208-230	56HC	N280	056C17V5303	√	\$1,103	F3	5.4/3.0-2.7	35	12.20	N, 5
1/2	3600	115/208-230	56HC	N281	056C34V5302	√	\$1,286	F3	7.6/4.0-3.8	38	12.20	N, 5
	1800	115/208-230	56HC	N282	056C17V5301	√	\$1,339	F3	6.6/3.5-3.3	38	12.70	N, 5
3/4	1800	115/208-230	56HC	N283	056B17V5303	√	\$1,493	F3	7.6/4.2-3.8	42	12.70	N, 1, 5
1	3600	115/208-230	56HC	N284	056C34V5301	√	\$1,433	F3	12.0/6.8-6.0	49	13.70	N, 5
	1800	115/208-230	56HC	N285	056B17V5304	√	\$1,533	F3	9.0/5.0-4.5	49	13.70	N, 1, 5
1 1/2	3600	115/208-230	56HC	N286	056B34W5301	√	\$1,509	F3	13.6/7.2-6.8	49	13.81	V, 1
	1800	115/208-230	145TC	N287	145TBWD5329	√	\$1,626	F3	14.8/7.8-7.4	53	14.81	V, 1
2	3600	115/208-230	145TC	N288	145TBWD5301	√	\$1,798	F3	17.6/9.8-8.8	57	14.81	V, 1
	1800	115/208-230	145TC	N289	145TBWD5328	√	\$1,994	F3	20.0/10.2-10.0	57	14.81	V, 1

WASHDOWN

Viton is believed to be the trademark or trade name of The Chemours Company FC and is not owned or controlled by Regal Beloit Corporation.

Prices and specifications are subject to change without notice.

POWERWASH™ SXT-PLUS WASH DOWN DUTY®, THREE PHASE MOTORS

STAINLESS/BISSC, TOTALLY ENCLOSED MOTORS

FEATURES:

- Suitable for use on VFD 10:1 variable torque, 10:1 (TEFC) or 1000:1 (TENV) constant torque, 1.0 service factor
- MAX GUARD® Class F insulation system
- 1.15 service factor on sinewave, 1.0 service factor on IGBT power
- Double sealed ball bearings with moisture resistant, high temperature grease
- 300 series stainless steel external construction: frame, endshields, shaft, conduit box, mounting base and hardware for superior corrosion resistance
- Internal corrosion resistant coatings on rotor and heavy polyester varnish on the stator
- 100% paint-free construction
- Viton® o-rings, shaft seals, and gaskets for superior sealing against chemicals
- Hydrophobic breather in OP endshield and conduit box equalize air pressure
- Nameplate information laser etched on frame
- BISSC certified for baking industry
- UL recognized, CSA certified and CE mark



C-FACE FOOTLESS

HP	RPM	VOLTS	FRAME	CAT. NO.	MODEL NO.	STOCK	LIST PRICE	MULT. SYMB.	NOM. EFF.	F.L. AMPS	WT.	"C" DIM.	FOOT NOTES
1/3	1800	208-230/460	48C	N460	048T17V2001	√	\$1,428	F3	72.0	1.4-1.4/7	37	9.83	N, 13
1/2	3600	208-230/460	56C	N480A	056T34V5316	√	\$1,340	F3	82.5	1.8-1.7/85	31	10.47	N, 13
	1800	208-230/460	48C	N461	048T17V2002	√	\$1,465	F3	76.0	2.3-2.2/1	35	11.58	N, 13
3/4	1800	208-230/460	56C	N462A	056T17V5353	√	\$1,554	F3	78.5	1.9-1.8/9	36	11.22	N, 13
	3600	208-230/460	56C	N481A	056T34V5317	√	\$1,474	F3	84.0	2.8-2.6/1.3	35	10.97	N, 13
1	1800	208-230/460	56C	N463A	056T17V5352	√	\$1,591	F3	80.0	2.7-2.5/1.25	41	11.72	N, 13
	3600	208-230/460	56C	N482A	056T34V5313	√	\$1,565	F3	85.5	3.2-3/1.5	45	12.22	N, 13
1 1/2	1800	230/460	56C	N464B	056T17W99037	√	\$2,032	F3	85.5	3.6/1.8	44	11.94	
	1800	230/460	56C	N465B	056T17W99040	√	\$2,032	F3	85.5	3.6/1.8	49	11.94	
	1800	230/460	143TC	N466A	143TTWD16037	√	\$2,032	F3	85.5	3.6/1.8	45	12.00	
	1800	230/460	143TC	N467	143TTWD14032	√	\$2,027	F3	82.5	3.4/1.7	36	13.19	d, V, 13
	1800	230/460	143TC	N467A	143TTWD16036	√	\$2,032	F3	85.5	3.6/1.8	46	12.00	13
	3600	230/460	143TC	N483A	143TTWD16005	√	\$1,898	F3	84.0	5.0/2.5	43	12.00	
2	1800	208-230/460	56C	N468A	056T17W5330	√	\$1,852	F3	84.0	4.9-4.8/2.4	41	13.63	d, V, 13
	1800	230/460	56C	N468B	056T17W99028	√	\$2,212	F3	86.5	5.4/2.7	49	12.69	
	1800	230/460	145TC	N469	145TTWD14034	√	\$2,109	F3	84.0	4.8/2.4	54	13.69	d, V, 13
	1800	230/460	145TC	N469A	145TTWD16034	√	\$2,212	F3	86.5	5.4/2.7	54	12.75	
	3600	230/460	145TC	N484	145TTWD14005	√	\$1,752	F3	84.0	5.8/2.9	44	13.69	d, V, 13
3	3600	230/460	145TC	N484A	145TTWD16007	√	\$2,030	F3	85.5	5.4/2.7	40	12.75	13
	1800	208-230/460	56C	N470A	056T17W5332	√	\$1,892	F3	84.0	6.8-6.4/3.2	47	13.63	d, V, 13
	1800	230/460	56C	N470B	056T17W99034	√	\$2,228	F3	86.5	6.4/3.2	53	13.19	13
	1800	230/460	145TC	N471A	145TTWD16036	√	\$2,228	F3	86.5	6.4/3.2	82	13.25	
5	3600	230/460	145TC	N485A	145TTWD16008	√	\$2,228	F3	86.5	9.2/4.6	56	13.00	13
	1800	230/460	182TC	N448B	182TTWD16026	√	\$3,450	F3	89.5	8.8/4.4	65	14.77	13
5	3600	230/460	184TC	N486	184TTWD14002	√	\$2,529	F3	87.5	14.0/7.0	92	14.77	d, V, 13
	3600	230/460	184TC	N486A	184TTWD16004	√	\$3,057	F3	88.5	13.6/6.8	97	15.27	13
	1800	230/460	184TC	N449B	184TTWD16032	√	\$3,736	F3	89.5	14.4/7.2	75	15.77	

Catalog numbers (Cat No.) highlighted in bold blue are premium efficient.

Continued on next page.

Viton is believed to be the trademark or trade name of The Chemours Company FC and is not owned or controlled by Regal Beloit Corporation.

Prices and specifications are subject to change without notice.

POWERWASH™ SXT-PLUS WASH DOWN DUTY®, THREE PHASE MOTORS

STAINLESS/BISSC, TOTALLY ENCLOSED MOTORS

C-FACE FOOTED (RIGID BASE)

Same features as shown on page 131

HP	RPM	VOLTS	FRAME	CAT. NO.	MODEL NO.	STOCK	LIST PRICE	MULT. SYMB.	NOM. EFF.	F.L. AMPS	WT.	"C" DIM.	FOOT NOTES
1/2	3600	208-230/460	56HC	N439A	056T34V5314	✓	\$1,366	F3	82.5	1.8-1.7/.85&2/1	34	10.47	N, 5, 13
	1800	208-230/460	56HC	N400	056T17V5347	✓	\$1,540	F3	78.5	1.8/.9	37	12.54	N, 5, 13
	1200	208-230/460	56HC	N180A	056T11V5379	✓	\$1,535	F3	77.0	2.45-2.4/1.2&2/1	41	11.47	N, 5, 13
3/4	3600	208-230/460	56HC	N440A	056T34V5312	✓	\$1,500	F3	84.0	2.8-2.6/1.3&2.2/1.1	35	10.97	N, 5, 13
	1800	208-230/460	56HC	N401	056T17V5348	✓	\$1,599	F3	80.0	2.7-2.5/1.25	42	13.04	N, 5, 13
	1200	208-230/460	56HC	N181A	056T11V5380	✓	\$1,613	F3	78.5	3.4-3.2/1.6&2.6/1.3	51	13.22	N, 5, 13
1	3600	208-230/460	56C	N441A	056T34V5315	✓	\$1,764	F3	85.5	3.2-3/1.5&2.8/1.4	46	13.22	N, 5, 13
	1800	208-230/460	56HC	N402	056T17V5349		\$1,635	F3	81.5	3.5-3.3/1.65	47	13.54	d, N, 5, 13
	1800	230/460	56HC	N402A	056T17W99041	✓	\$1,635	F3	85.5	3.6/1.8	45	13.81	
	1800	208-230/460	56C	N291	056T17W5329		\$1,635	F3	82.5	3.5-3.4/1.7&4/2	36	13.13	d, V, 5, 13
	1800	230/460	56C	N291A	056T17W99039	✓	\$1,635	F3	85.5	3.6/1.8&3.8/1.9	38	11.94	
	1800	230/460	143TC	N403A	143TTWD16039	✓	\$1,635	F3	85.5	3.6/1.8	44	12.37	
	1800	230/460	143TC	N292	143TTWD16031	✓	\$1,635	F3	85.5	3.6/1.8&4.0/2.0	44	12.00	13
	1200	208-230/460	56HC	N182A	056T11W5379		\$1,697	F3	77.0	4.1-4.2/2.1&4.0/2.0	43	13.13	d, 5, 13
	1200	230/460	56HC	N182B	056T11W99004	✓	\$1,844	F3	82.5	4.2/2.0/1.0&4.0/2.0	50	12.69	13
	1 1/2	3600	230/460	143TC	N442A	143TTWD16002	✓	\$2,105	F3	84.0	5.0/2.5&4.0/2.0	41	11.75
1800		208-230/460	56HC	N293	056T17W5336		\$1,750	F3	84.0	4.9-4.8/2.4&4.0/2.0	43	13.63	d, 5, 13
1800		230/460	56HC	N293A	056T17W99029	✓	\$1,913	F3	86.5	5.4/2.7&4.0/2.0	50	12.69	
1800		230/460	145TC	N404A	145TTWD6026	✓	\$1,913	F3	86.5	5.4/2.7&6.1-6.3	49	12.75	
1200		208-230/460	56HC	N183A	056T11W5380		\$2,051	F3	80.0	6.2-6/3.0&5.0/2.5	52	14.13	d, 5, 13
1200		230/460	182TC	N183B	182TTWD16076	✓	\$2,509	F3	87.5	6.4/3.2&5.6/2.8	89	14.77	13
2	3600	230/460	145TC	N443A	145TTWD16003	✓	\$3,135	F3	85.5	5.6/2.8&6.8/3.4	58	12.75	13
	1800	208-230/460	56HC	N294	056T17W5337		\$2,204	F3	84.0	6.8-6.4/3.2&5.8/2.9	50	13.63	d, 5, 13
	1800	230/460	56HC	N294A	056T17W99033	✓	\$2,376	F3	86.5	6.4/3.2&6.2/3.1	56	13.19	13
	1800	230/460	145TC	N405A	145TTWD6027	✓	\$2,376	F3	86.5	7.0/3.5&8.0/4.0	49	13.25	
3	3600	230/460	145TC	N444	145TTWD16002	✓	\$3,199	F3	86.5	9.2/4.6&7.8/3.0	52	13.00	13
	1800	230/460	182TC	N406A	182TTWD6031	✓	\$2,854	F3	89.5	8.8/4.0	88	14.77	13
5	3600	230/460	184TC	N445A	184TTWD16002	✓	\$3,581	F3	88.5	14.0/7.0&16.0/8.0	99	15.27	13
	1800	230/460	184TC	N407A	184TTWD6031	✓	\$3,256	F3	89.5	14.4/7.2	96	15.77	
7 1/2	3600	230/460	213TC	N446A	213TTWD16002	✓	\$4,711	F3	90.2	20.0/10.0&16.6/8.3	145	18.69	13
	1800	230/460	213TC	N408A	213TTWD6031	✓	\$4,871	F3	91.7	25.2/12.6&24.8/12.4	174	18.69	13
10	3600	230/460	215TC	N447A	215TTWD16002	✓	\$4,920	F3	91.7	26.0/13.0&24.8/12.4	192	18.69	13
	1800	230/460	213TC	N409A	215TTWD6031	✓	\$5,017	F3	91.7	32.4/16.2&31.2/15.6	189	18.69	13

Catalog numbers (Cat No.) highlighted in bold blue are premium efficient.

POWERWASH™ COUPLER BRAKE KITS

PowerWash™ coupler brakes are specifically designed for use with PowerWash Wash Down Duty Motors. Rated for NEMA® 4X/IP55, these brakes are suitable for applications with high moisture or pressure washdown. Painted with a special white epoxy food-safe paint, these brakes are BISSC certified.

ENCLOSURE NEMA 4X/IP55	CAT. NO.	KIT NO.	STOCK	LIST PRICE	MULT. SYMB.	WEIGHT
3 Lb/Ft	A909	KIT 909	✓	\$1,203	S4	12
6 Lb/Ft	A910	KIT 910	✓	\$1,301	S4	12
10 Lb/Ft	A911	KIT 911	✓	\$1,430	S4	13

POWERWASH™ SXT-PLUS WASH DOWN DUTY®, THREE PHASE MOTORS

STAINLESS/BISSC, TOTALLY ENCLOSED MOTORS

CLOSE COUPLED PUMP, JM, RIGID BASE

Same features as shown on page 131

HP	RPM	VOLTS	FRAME	CAT. NO.	MODEL NO.	STOCK	LIST PRICE	MULT. SYMB.	NOM. EFF.	FL. AMPS	WT.	"C" DIM.	FOOT NOTES
1	1800	230/460	143JM	N151	143TTWD14031		\$1,312	F3	82.5	3.1/1.55	45	16.00	d, V
	1800	230/460	143JM	N151A	143TTWD16038	√	\$1,431	F3	85.5	3.2/1.6	35	16.00	
1 1/2	3600	230/460	143JM	N152A	143TTWD16006	√	\$1,431	F3	84.0	4.4-4/2	47	16.00	
	1800	230/460	145JM	N153	145TTWD14031		\$1,339	F3	84.0	4.4/2.2	50	16.00	d, V
2	1800	230/460	145JM	N153A	145TTWD16035	√	\$1,465	F3	86.5	4.8/2.4	50	16.50	
	3600	230/460	145JM	N154	145TTWD14002		\$1,559	F3	84.0	5.2/2.6	57	16.00	d, V
3	3600	230/460	145JM	N154A	145TTWD16009	√	\$1,701	F3	85.5	4.8/2.4	50	16.50	
	1800	230/460	145JM	N155A	145TTWD16037	√	\$1,721	F3	86.5	5.8/2.9	57	17.00	
5	3600	230/460	145JM	N156	145TTWD14003		\$1,874	F3	85.5	7.6/3.8	62	16.50	d, V
	3600	230/460	145JM	N156A	145TTWD16006	√	\$2,045	F3	86.5	8.8-8/4	58	16.50	
7 1/2	1800	230/460	182JM	N157	182TTWD14033		\$1,983	F3	87.5	8.6/4.3	79	16.20	d, V, 13
	1800	230/460	182JM	N157A	182TTWD16027	√	\$2,191	F3	89.5	7.8/3.9	79	16.20	
10	3600	230/460	184JM	N158A	184TTWD16003	√	\$2,389	F3	88.5	12.0/6.	100	16.77	
	1800	230/460	184JM	N159	184TTWD14033		\$2,198	F3	87.5	12.0/6.0	88	16.77	d, V, 13
13	1800	230/460	184JM	N159A	184TTWD16033	√	\$2,410	F3	89.5	12.6/6.3	118	17.27	
	3600	230/460	213JM	N160	213TTWD14002		\$3,329	F3	88.5	18.4/9.2	200	16.81	d, V
16	3600	230/460	213JM	N160A	213TTWD16003	√	\$3,702	F3	89.5	18.6/9.3	170	19.81	
	1800	230/460	213JM	N161	213TTWD14032		\$3,403	F3	89.5	22.0/11.0	157	19.81	d, V
19	1800	230/460	213JM	N161A	213TTWDD16026	√	\$3,753	F3	91.7	19.6/9.8	153	19.81	
	3600	230/460	215JM	N162A	215TTWD16003	√	\$3,881	F3	90.2	23.6/11.8	182	19.81	
22	1800	230/460	215JM	N163	215TTWD14032		\$3,509	F3	89.5	28.0/14.0	170	19.81	d, V
	1800	230/460	215JM	N163A	215TTWD16026	√	\$3,863	F3	91.7	26.4/13.2	200	19.81	

Catalog numbers (Cat No.) highlighted in bold blue are premium efficient.

BRAKEMOTOR, C-FACE FOOTED (RIGID BASE)

HP	RPM	VOLTS	FRAME	CAT. NO.	MODEL NO.	STOCK	LIST PRICE	MULT. SYMB.	NOM. EFF.	FL. AMPS	WT.	BRAKE RATING (Lb/Ft)	"C" DIM.	FOOT NOTES
1/2	1800	208-230/460	56HC	N388A	056T17V5354	√	\$4,413	F3	78.5	1.7-1.6/8	59	3	16.51	N, 13
1	1800	208-230/460	56HC	N389A	056T17V5355		\$4,649	F3	81.5	3.1-3/1.5	69	6	15.85	d, N, 13
	1800	230/460	56HC	N389B	056T17V99029	√	\$4,980	F3	85.5	3.2/1.6	70	6	17.75	

Catalog numbers (Cat No.) highlighted in bold blue are premium efficient.

Continued on next page.

POWERWASH™ SXT-PLUS WASH DOWN DUTY®, THREE PHASE MOTORS

STAINLESS/BISSC, TOTALLY ENCLOSED MOTORS

IEC B5 FOOTLESS

Same features as shown on page 131

HP	RPM	VOLTS	FRAME	CAT. NO.	MODEL NO.	STOCK	LIST PRICE	MULT. SYMB.	NOM. EFF.	FL. AMPS	WT.	"C" DIM.	FOOT NOTES
1/3 - .25	1800	208-230/460	71	R700	071T17V5326	✓	\$1,167	F3	72.0	1.3-1.3/.65	37	9.87	N
	1800	208-230/460	80	R701	080T17V5326	✓	\$1,167	F3	72.0	1.3-1.3/.65	28	9.72	N
1/2 - .37	1800	208-230/460	71	R702	071T17V5327	✓	\$1,206	F3	76.0	1.9-1.8/0.9	37	11.62	N
	1800	208-230/460	80	R703	080T17V5331	✓	\$1,206	F3	76.0	1.9-1.8/0.9	36	11.47	N
3/4 - .55	1800	208-230/460	80	R704	080T17W5326	✓	\$1,278	F3	78.5	2.5-2.4/1.2	40	12.26	V
1 - .75	1800	230/460	90L	R705A	090LT17W6026	✓	\$1,490	F3	85.5	3.2/1.6	44	12.59	
1 1/2 - 1.1	1800	208-230/460	90L	R706	090LT17W4027	✓	\$1,434	F3	84.0	4.5-4.4/2.2	46	13.63	d, V
	1800	230/460	90L	R706A	090LT17W6027	✓	\$1,565	F3	86.5	4.8/2.4	68	13.34	
2 - 1.5	1800	208-230/460	90L	R707	090LT17W4028	✓	\$1,592	F3	84.0	6-5.6/2.8	68	13.63	d, V
	1800	230/460	90L	R707A	090LT17W6028	✓	\$1,739	F3	86.5	5.8/2.9	68	13.84	

Catalog numbers (Cat No.) highlighted in bold blue are premium efficient.

B5 FOOTED (RIGID BASE)

HP	RPM	VOLTS	FRAME	CAT. NO.	MODEL NO.	STOCK	LIST PRICE	MULT. SYMB.	NOM. EFF.	FL. AMPS	WT.	"C" DIM.	FOOT NOTES
1/3 - .25	1800	208-230/460	80	R710	080T17V5327	✓	\$1,186	F3	72.0	1.3-1.3/.65	31	10.75	N
1/2 - .37	1800	208-230/460	80	R711	080T17V5333	✓	\$1,224	F3	76.0	1.9-1.8/0.9	38	12.75	N
3/4 - .55	1800	208-230/460	80	R712	080T17W5327	✓	\$1,304	F3	78.5	2.5-2.4/1.2	41	12.26	V

B14 FOOTLESS

HP	RPM	VOLTS	FRAME	CAT. NO.	MODEL NO.	STOCK	LIST PRICE	MULT. SYMB.	NOM. EFF.	FL. AMPS	WT.	"C" DIM.	FOOT NOTES
1/3 - .25	1800	208-230/460	71	R720	071T17V5328	✓	\$1,167	F3	72.0	1.3-1.3/.65	29	9.83	N
	1800	208-230/460	80	R721	080T17V5328	✓	\$1,167	F3	72.0	1.3-1.3/.65	28	9.72	N
1/2 - .37	1800	208-230/460	71	R722	071T17V5329	✓	\$1,206	F3	76.0	1.9-1.8/0.9	42	11.58	N
	1800	208-230/460	80	R723	080T17V5329	✓	\$1,206	F3	76.0	1.9-1.8/0.9	38	11.47	N
3/4 - .55	1800	208-230/460	80	R724	080T17W5328	✓	\$1,278	F3	78.5	2.5-2.4/1.2	38	12.48	V

B14 FOOTED (RIGID BASE)

HP	RPM	VOLTS	FRAME	CAT. NO.	MODEL NO.	STOCK	LIST PRICE	MULT. SYMB.	NOM. EFF.	FL. AMPS	WT.	"C" DIM.	FOOT NOTES
1/3 - .25	1800	208-230/460	80	R730	080T17V5330	✓	\$1,206	F3	72.0	1.3-1.3/.65	27	10.22	N
1/2 - .37	1800	208-230/460	80	R731	080T17V5332	✓	\$1,334	F3	76.0	1.9-1.8/0.9	35	11.47	N
3/4 - .55	1800	208-230/460	80	R732	080T17W5329	✓	\$1,380	F3	78.5	2.5-2.4/1.2	40	12.48	V

WASHDOWN

POWERWASH™ EXTREME WASH DOWN DUTY®, THREE PHASE MOTORS

STAINLESS/BISSC, TOTALLY ENCLOSED MOTORS

FEATURES:

- Complete motor encapsulation
- Suitable for use on VFD 10:1 variable torque, 10:1 (TEFC) or 1000:1 (TENV) constant torque, 1.0 service factor
- MAX GUARD® Class F insulation system
- Potted lead entrance
- 1.15 service factor on sinewave, 1.0 service factor on IGT power
- Double sealed ball bearings with moisture resistant, high temperature grease
- 300 series stainless steel external construction: frame, endshields, shaft, conduit box, mounting base and hardware for superior corrosion resistance
- 100% paint-free construction
- Viton® o-rings, shaft seals, and gaskets for superior sealing against chemicals
- Nameplate information laser etched on frame
- BISSC certified for baking industry
- UL recognized, CSA certified and CE mark



C-FACE FOOTLESS

HP	RPM	VOLTS	FRAME	CAT. NO.	MODEL NO.	STOCK	LIST PRICE	MULT. SYMB.	NOM. EFF.	F.L. AMPS	WT.	"C" DIM.	FOOT NOTES
1/3	1800	208-230/460	48C	N701	048T17V11001	√	\$1,885	F3	70.5	1.4-1.4/7	38	9.58	N
	3600	208-230/460	56C	N703	056T34V99013	√	\$1,769	F3	82.5	1.8-1.7/.85	36	10.47	N
1/2	1800	208-230/460	48C	N704	048T17V11002	√	\$1,933	F3	76.0	2.3-2.2/1.1	41	11.33	N
	1800	208-230/460	56C	N705	056T17V99016	√	\$2,051	F3	78.5	1.9-1.8/9	44	10.97	N
3/4	3600	208-230/460	56C	N707	056T34V99014	√	\$1,946	F3	84.0	2.8-2.6/1.3	40	10.72	N
	1800	208-230/460	56C	N708	056T17V99011	√	\$2,099	F3	80.0	2.7-2.5/1.25	45	11.47	N
1	3600	208-230/460	56C	N710	056T34V99011	√	\$2,066	F3	85.5	3.2-3/1.5	47	11.22	N
	1800	230/460	56C	N711A	056T17W99036	√	\$2,587	F3	85.5	3.6/1.8	32	11.94	
1 1/2	3600	230/460	143TC	N713	143TTWD16004	√	\$2,115	F3	84.0	5.0/2.5	46	11.69	
	1800	208-230/460	56C	N715	056T17W99007		\$2,445	F3	84.0	4.9-4.8/2.4	47	11.69	d
	1800	230/460	56C	N715A	056T17W99045	√	\$2,783	F3	86.5	5.4/2.7	80	17.75	
	1800	230/460	143TC	N716	143TTWD16033	√	\$2,783	F3	86.5	5.4/2.7	52	12.69	
2	3600	230/460	145TC	N718	145TTWD16004	√	\$2,313	F3	85.5	5.6/2.8	57	12.69	
	1800	208-230/460	56C	N720	056T17W99009		\$2,497	F3	84.0	6.8-6.4/3.2	53	13.25	d
	1800	230/460	56C	N720A	056T17W99032	√	\$2,834	F3	86.5	6.4/3.2	58	13.19	
	1800	230/460	145TC	N721	145TTWD16032	√	\$2,834	F3	86.5	7.0/3.5	53	13.19	

C-FACE FOOTED (RIGID BASE)

HP	RPM	VOLTS	FRAME	CAT. NO.	MODEL NO.	STOCK	LIST PRICE	MULT. SYMB.	NOM. EFF.	F.L. AMPS	WT.	"C" DIM.	FOOT NOTES
1/2	3600	208-230/460	56C	N753	056T34V99012	√	\$1,803	F3	82.5	1.7-1.6/8	37	10.47	N
	1800	208-230/460	56C	N755	056T17V99015	√	\$2,032	F3	78.5	1.7-1.6/8	44	10.97	N
3/4	3600	208-230/460	56C	N757	056T34V99015	√	\$1,979	F3	84.0	2.6-2.4/1.2	41	10.72	N
	1800	208-230/460	56C	N758	056T17V99014	√	\$2,110	F3	80.0	2.4-2.3/1.15	46	11.47	N
1	3600	208-230/460	56C	N760	056T34V99016	√	\$2,328	F3	85.5	2.8-2.6/1.3	44	11.22	N
	1800	208-230/460	56C	N761	056T17V99013		\$2,158	F3	81.5	3.1-3/1.5	32	11.97	d, N
	1800	230/460	56C	N761A	056T17W99038	√	\$2,332	F3	85.5	3.2/1.6	43	11.94	
1 1/2	3600	230/460	143TC	N763	143TTWD16003	√	\$2,780	F3	84.0	4.0/2.0	47	11.75	
	1800	208-230/460	56C	N765	056T17W99010		\$2,309	F3	84.0	4.5-4.4/2.2	48	11.69	d
	1800	230/460	56C	N765A	056T17W99030	√	\$2,525	F3	86.5	4.8/2.4	49	12.44	
	1800	230/460	143TC	N766	143TTWD16032	√	\$2,525	F3	86.5	4.8/2.4	55	12.75	
2	3600	230/460	145TC	N768	145TTWD16005	√	\$4,137	F3	85.5	4.8/2.4	55	12.75	
	1800	208-230/460	56C	N770	056T17W99008		\$2,910	F3	84.0	6-5.6/2.8	54	12.69	d
	1800	230/460	56C	N770A	056T17W99031	√	\$3,137	F3	86.5	5.8/2.9	62	13.25	
	1800	230/460	145TC	N771	145TTWD16031	√	\$3,137	F3	86.5	5.8/2.9	58	13.25	

Catalog numbers (Cat No.) highlighted in bold blue are premium efficient.

Viton is believed to be the trademark or trade name of The Chemours Company FC and is not owned or controlled by Regal Beloit Corporation. Prices and specifications are subject to change without notice.

CARBONATOR PUMP, SPLIT PHASE MOTORS

OPEN DRIPPROOF MOTORS

FEATURES:

- Resilient base (except as noted)
- Ball bearings
- Sleeve bearings, as noted
- 1.0 service factor (except as noted)
- Completely interchangeable with OEM units
- Automatic reset thermal protector
- UL recognized and CSA certified



HP	RPM	VOLTS	FRAME	CAT. NO.	MODEL NO.	STOCK	LIST PRICE	MULT. SYMB.	FL. AMPS	WT.	"C" DIM.	FOOT NOTES
1/4	1800/1500	208-240	48Y	HG451	5KH32GNB813X	√	\$266	F1	2.3-2.4	14	7.69	68
	1800/1500	115/230	48Z	H344	5KH36KNB633X	√	\$222	F1	4.3/2.2	16	8.75	
	1800	115	48Y	CB2024AV1	Century®	√	\$274	F1	4.4	12.0	8.1	4
	1800	115	48Y	4725	5KH32DN5587X	√	\$222	F1	5.0	13	7.69	
	1800	115	48Y	HG679	5KH32DN5597X	√	\$210	F1	5.0	11	7.69	12, 82
1/3	1800/1500	100-120/200-240	48Y	HG681	5KH32GNB814X	√	\$277	F1	5.5-5.6/2.7-2.8	14	7.69	12, 68, 82
	1800/1500	100-120/200-240	48Y	H683	5KH32GNA444X	√	\$312	F1	5.5-5.6/2.7-2.8	14	7.94	
	1800/1500	115/230	48	CB2034AD	Century	√	\$313	F1	4.6/2.3	15	8.6	4
	1800/1500	100-120/200-240	48Y	4805	5KH32GNB811X	√	\$290	F1	5.5-5.6/2.7-2.8	14	7.69	68
	1800/1500	220-240	48Y	HG450	5KH32GNB812X	√	\$281	F1	2.7-2.7	14	7.69	68
	1800	115	48Y	CB2034A	Century	√	\$244	F1	6.2	14	8.6	4, 16
	1800	115	48Y	4406	5KH32FN5586X	√	\$242	F1	5.6	14	7.69	18
	1800	115	48Y	HG680	5KH32FN5598X	√	\$233	F1	5.6	14	7.69	12, 18, 82
	1800	115	48Y	H682	5KH32ENA443X	√	\$281	F1	6.1	13	7.69	
1/2	1800	115	48Y	H926	5KH36MNB637X	√	\$362	F1	7.2	17	8.75	
	1800/1500	115/230	48	CB2054AD	Century	√	\$383	F1	6.8/3.4	18	8.8	4
	1800/1500	100-120/200-240	48Y	H684	5KH36MNA445X	√	\$362	F1	7.1-7.2/3.4-3.6	17	8.75	68
3/4	1800	115/230	48Y	HG714	5KH37PNA479X	√	\$481	F1	10.4/5.2	19	9.15	

DOUBLE SHAFT

HP	RPM	VOLTS	FRAME	CAT. NO.	MODEL NO.	STOCK	LIST PRICE	MULT. SYMB.	FL. AMPS	WT.	"C" DIM.	FOOT NOTES
1/3	1800/1500	100-120/200-240	48Y	H712	5KH32GNB815X	√	\$296	F1	5.5-5.6/2.7-2.8	14	9.47	68

SUMP PUMP, SPLIT PHASE MOTORS

DRIPPROOF MOTORS

FEATURES:

- Sleeve bearings
- 1.0 service factor
- Float switch & cord set
- Completely interchangeable with OEM units
- Automatic reset thermal protector
- UL recognized and CSA certified



CENTURY

HP	RPM	VOLTS	FRAME	CAT. NO.	MODEL NO.	STOCK	LIST PRICE	MULT. SYMB.	FL. AMPS	WT.	"C" DIM.	FOOT NOTES
1/3	1725	115	48Y	SP2030A	Century®	√	\$279	F1	6.0	12.0	9.3	
	1725	115	48Y	SP2034A	Century	√	\$375	F1	6.0	12.0	9.3	137
1/2	1725	115	48Y	SP2050A	Century	√	\$338	F1	7.3	13	9.8	

JET PUMP, TWO-COMPARTMENT MOTORS

SINGLE PHASE, DRIPPROOF MOTORS



FEATURES:

- Two-compartment design for easy servicing
- Not for use in pool pump applications
- 50° C ambient, as noted
- Fixed CW rotation, viewed opposite shaft end
- UL recognized and CSA certified

C-FACE FOOTLESS, 56C/56J

HP	RPM	VOLTS	FRAME	CAT. NO.	MODEL NO.	STOCK	LIST PRICE	MULT. SYMB.	SERVICE FACTOR	FL. AMPS	WT.	"C" DIM.	FOOT NOTES
1/3	3600	115	56C	H439	5KH39EN2552X	√	\$301	F1	1.75	6.2	18	11.03	3, 69
	3600	115	56J	H440	5KH39EN2506X	√	\$306	F1	1.75	6.2	18	11.54	3, 69
	3600	115/230	56C	C1081	5KC39EN2553X	√	\$333	F1	1.75	6.2/3.1	15	11.03	2, 69
	3600	115/230	56J	C1087	5KC39EN2500X	√	\$343	F1	1.75	6.2/3.1	15	11.54	2, 69
1/2	3600	115/230	56C	C1082	5KC39HN2554X	√	\$349	F1	1.60	8.2/4.1	15	11.03	2, 69
	3600	115/230	56J	C1088	5KC39HN2501X	√	\$357	F1	1.60	8.2/4.1	15	11.54	2, 69
3/4	3600	115/230	56C	C1083	5KC33MN2555X	√	\$387	F1	1.50	11.6/5.8	17	12.01	18, 82
	3600	115/230	56C	C1083A	5KC39PN5105X	√	\$387	F1	1.50	13.0/6.5	17	13.47	18, 69, 8 2
	3600	115/230	56J	C1089	5KC33MN2502X	√	\$397	F1	1.50	11.6/5.8	17	12.42	2
	3600	115/230	56J	C1089A	5KC39PN6200X	√	\$397	F1	1.50	13.0/6.5	17	12.52	2, 69
1	3600	115/230	56C	C1084	5KC39SN2810X	√	\$443	F1	1.40	14.2/7.1	25	13.47	2, 69
	3600	115/230	56J	C1090	5KC39SN2812X	√	\$454	F1	1.40	14.2/7.1	26	13.98	2, 69
1 1/2	3600	115/230	56C	C1085	5KCR39SN2557X	√	\$590	F1	1.30	15.8/7.9	21	13.47	1, 69
	3600	115/230	56J	C1091	5KCR39SN2504X	√	\$601	F1	1.30	15.8/7.9	21	13.98	1, 69
2	3600	115/230	56C	C1086	5KCR39UN2558X	√	\$720	F1	1.20	19.2/9.6	23	13.47	1, 69
	3600	115/230	56J	C1092	5KCR39UN2505X	√	\$730	F1	1.20	19.2/9.6	23	13.98	1, 69

C-FACE FOOTED (RIGID BASE), 56J

HP	RPM	VOLTS	FRAME	CAT. NO.	MODEL NO.	STOCK	LIST PRICE	MULT. SYMB.	SERVICE FACTOR	FL. AMPS	WT.	"C" DIM.	FOOT NOTES
1/3	3600	115	56J	H685	5KH39EN2887X	√	\$319	F1	1.75	6.2	13	11.54	3, 69
1/2	3600	115/230	56J	C1462	5KC39HN2888X	√	\$367	F1	1.60	8.2/4.1	16	11.54	18, 69
3/4	3600	115/230	56J	C1463	5KC33MN2889X	√	\$408	F1	1.50	11.6/5.8	19	12.42	2
	3600	115/230	56J	C1463A	5KC39PN6201X	√	\$408	F1	1.50	13.0/6.5	19	12.52	2, 69
1	3600	115/230	56J	C1464	5KC39SN2890X	√	\$461	F1	1.40	14.2/7.1	26	13.98	2, 69
1.5	3600	115/230	56J	C1465	5KCR39SN2891X	√	\$609	F1	1.30	15.8/7.9	21	13.98	1, 69
2	3600	115/230	56J	C1466	5KCR39UN2892X	√	\$738	F1	1.20	19.2/9.6	23	13.98	1, 69

SQUARE - FLANGE

HP	RPM	VOLTS	FRAME	CAT. NO.	MODEL NO.	STOCK	LIST PRICE	MULT. SYMB.	SERVICE FACTOR	FL. AMPS	WT.	"C" DIM.	FOOT NOTES
1/3	3600	115/230	56Y	C1168	5KC36GN2507X	√	\$343	F1	1.95	6.4/3.2	15	11.59	2
1/2	3600	115/230	56Y	C1169	5KC36MN2508X	√	\$344	F1	1.90	10.8/5.4	17	11.59	2
3/4	3600	115/230	56Y	C1170	5KC38PN2509X	√	\$362	F1	1.65	12.6/6.3	19	12.59	2
1	3600	115/230	56Y	C1171	5KC38SN2510X	√	\$408	F1	1.65	16.4/8.2	21	12.59	2
1 1/2	3600	230	56Y	C1172	5KCR39UN2511X	√	\$467	F1	1.50	7.6	23	13.12	1
2	3600	230	56Y	C1173	5KCR39UN2512X	√	\$622	F1	1.30	8.7	23	13.12	1

JET PUMP MOTORS

SINGLE PHASE, DRIPPROOF MOTORS

FEATURES:

- Capacitor start designs except as noted
- Internally mounted capacitor
- 50° C ambient, as noted
- Sealed switch design
- Ball bearings
- 56C (keyed shaft) and 56J (threaded shaft)
- Rotation CCW pump end (except for K1032, K1052, K1072, K1102, K1152, K1202 are reversible)



C-FACE FOOTLESS, 56C/56J

HP	RPM	VOLTS	FRAME	CAT. NO.	MODEL NO.	STOCK	LIST PRICE	MULT. SYMB.	SERVICE FACTOR	F.L. AMPS	WT.	"C" DIM.	FOOT NOTES
1/3	3600	115/230	56C	K1030	Century®	√	\$343	F1	1.80	8.6/4.3	15	8-1/4	
	3600	115/230	56C	K1032	Century	√	\$343	F1	1.80	8.6/4.3	16	8-1/4	
	3600	115/230	56J	T1032	Century	√	\$353	F1	1.80	8.6/4.3	16	8-1/4	143
1/2	3600	115/230	56C	K1050	Century	√	\$389	F1	1.60	10.8/5.4	17	8-5/8	
	3600	115/230	56C	K1052	Century	√	\$389	F1	1.60	10.8/5.4	18	8-5/8	
	3600	115/230	56J	T1052	Century	√	\$395	F1	1.60	10.8/5.4	18	8-5/8	143
3/4	3600	115/230	56C	K1070	Century	√	\$456	F1	1.50	14.8/7.4	19	9-1/2	
	3600	115/230	56C	K1072	Century	√	\$456	F1	1.50	14.8/7.4	21	9-1/2	
	3600	115/230	56J	T1072	Century	√	\$465	F1	1.50	14.8/7.4	19	9-1/2	143
1	3600	115/230	56C	K1100	Century	√	\$508	F1	1.40	16.2/8.1	22	10	
	3600	115/230	56C	K1102	Century	√	\$508	F1	1.40	16.2/8.1	22	10	
	3600	115/230	56J	T1102	Century	√	\$517	F1	1.40	16.2/8.1	23	10	143
1 1/2	3600	115/230	56C	K1150	Century	√	\$693	F1	1.30	22.0/11.0	30	11-5/16	
	3600	115/230	56C	K1152	Century	√	\$693	F1	1.30	22.0/11.0	27	11-5/16	
	3600	115/230	56J	T1152	Century	√	\$724	F1	1.30	22.0/11.0	27	11-5/16	143
2	3600	115/230	56C	K1200	Century	√	\$805	F1	1.20	22.6/11.3	30	11-15/16	1
	3600	115/230	56C	K1202	Century	√	\$805	F1	1.20	22.6/11.3	30	11-15/16	1
	3600	115/230	56J	T1202	Century	√	\$876	F1	1.20	22.6/11.3	30	11-15/16	1

SQUARE-FLANGE

HP	RPM	VOLTS	FRAME	CAT. NO.	MODEL NO.	STOCK	LIST PRICE	MULT. SYMB.	SERVICE FACTOR	F.L. AMPS	WT.	"C" DIM.	FOOT NOTES
1/3	3600	115/230	48Y	Q1032	Century	√	\$363	F1	1.95	9.9/4.95	19	9.63	
1/2	3600	115/230	48Y	Q1052	Century	√	\$407	F1	1.90	12.4/6.2	18	10.38	
3/4	3600	115/230	48Y	Q1072	Century	√	\$479	F1	1.65	14.8/7.4	23	11	
1	3600	115/230	48Y	Q1102	Century	√	\$532	F1	1.65	19.9/9.95	27	11.88	
1 1/2	3600	115/230	48Y	Q1152	Century	√	\$745	F1	1.47	24.0/12.0	31	12.63	
2	3600	115/230	48Y	Q1202	Century	√	\$837	F1	1.25	24.0/12.0	33	12.63	1

CENTRIFUGAL PUMP (JET PUMP) MOTORS

SINGLE PHASE, DRIPPROOF MOTORS

FEATURES:

- Service factor, as noted
- Double sealed ball bearings, mechanically locked on shaft end
- Capacitor start/capacitor run design for higher efficiency, as noted
- Fixed CW rotation, viewed opposite shaft end
- Automatic reset thermal protector
- 56C = carbon steel shaft with key
- 56J = 416 stainless steel threaded shaft with slinger
- Drip cover not included, see accessories section
- UL recognized and CSA certified



C-FACE FOOTLESS, 56C/56J

HP	RPM	VOLTS	FRAME	CAT. NO.	MODEL NO.	STOCK	LIST PRICE	MULT. SYMB.	SERVICE FACTOR	FL. AMPS	WT.	"C" DIM.	FOOT NOTES
1/3	3600	115/230	56C	J1025	5KC37FN71X	√	\$245	F1	1.75	6.4/3.2	14	10.71	
	3600	115/230	56J	C329	5KC37FN65X	√	\$258	F1	1.75	6.4 / 3.0-3.2	14	11.22	15
	1800/1500	115/208-230	56J	C683	5KC36LN84X	√	\$558	F1	1.35	6.0/3.2-3.0	17	10.82	15, 50
1/2	3600	115/230	56C	C330	5KC36JN268X	√	\$269	F1	1.60	7.6/3.8	18	10.31	
	3600	115/230	56J	C331	5KC36JN269X	√	\$281	F1	1.60	7.6/3.8	18	10.82	15
3/4	3600	115/230	56C	C332	5KC39NN50X	√	\$317	F1	1.50	11.2/5.6	19	11.84	
	3600	115/230	56J	C333	5KC39QN3219X	√	\$328	F1	1.50	11.2/5.6	18	12.40	15
	3000	110/220	56C	CG732	5KC39RN114T	√	\$545	F1	1.50	9.8/4.9	28	12.60	50
1	3600	115/230	56C	C334	5KC39RN44X	√	\$355	F1	1.40	13.2/6.6	22	12.59	
	3600	115/230	56J	C335	5KC39RN45X	√	\$365	F1	1.40	13.2/6.6	22	13.14	15
1 1/2	3600	115/208-230	56C	C336	5KC49NN2140X	√	\$485	F1	1.30	18.4/9.8-9.2	27	11.38	
	3600	115/230	56J	C337	5KC49NN2167X	√	\$515	F1	1.30	18.4/9.2	26	11.89	
2	3600	115/208-230	56C	C338	5KC49TN2141X	√	\$601	F1	1.20	21.2/11.5-10.6	38	13.22	
	3600	115/208-230	56J	C339	5KC49TN2170X	√	\$631	F1	1.20	21.2/10.6	36	13.73	
3	3600	115/230	56C	C340	5KCR48TN2142T	√	\$955	F1	1.15	29.4/14.7	38	12.66	1
	3600	115/230	56J	C341	5KCR48TN2174T	√	\$1,006	F1	1.15	29.4/14.7	38	13.17	1, 15

C-FACE FOOTED (RIGID BASE), 56J

ADDITIONAL FEATURES: Drip cover included

HP	RPM	VOLTS	FRAME	CAT. NO.	MODEL NO.	STOCK	LIST PRICE	MULT. SYMB.	SERVICE FACTOR	FL. AMPS	WT.	"C" DIM.	FOOT NOTES
1/3	3600	115/208-230	56J	J054	056C34D2118	√	\$266	F1	1.75	5.6/2.7-2.8	15	10.94	
1/2	3600	115/208-230	56J	J055	056C34D2119	√	\$288	F1	1.60	7.4/3.5-3.7	17	11.19	
3/4	3600	115/208-230	56J	J056	056C34D2120	√	\$336	F1	1.50	9.8/4.8-4.9	20	11.44	
1	3600	115/208-230	56J	J057	056C34D2121	√	\$373	F1	1.40	12.0/6.2-6.0	23	12.44	
1 1/2	3600	115/208-230	56J	J058	056B34D2033	√	\$521	F1	1.30	13.4/7.4-6.7	23	12.43	1
2	3600	115/208-230	56J	J059	056B34D5341	√	\$641	F1	1.20	18.2/9.8-9.1	33	11.94	1

SINGLE PHASE, TOTALLY ENCLOSED MOTORS

FEATURES:

- Service factor, as noted
- Double sealed ball bearings, mechanically locked on shaft end
- Capacitor start/capacitor run design for higher efficiency, as noted
- Reversible CW rotation, viewed opposite shaft end
- Automatic reset thermal protector
- 56C = carbon steel shaft with key
- 56J = 416 stainless steel threaded shaft with slinger
- Drip cover not included, see accessories section
- UL recognized and CSA certified



C-FACE FOOTLESS, 56C/56J

HP	RPM	VOLTS	FRAME	CAT. NO.	MODEL NO.	STOCK	LIST PRICE	MULT. SYMB.	SERVICE FACTOR	FL. AMPS	WT.	"C" DIM.	FOOT NOTES
1/3	3600	115/230	56J	C1336	5KC33FN4180X	√	\$449	F1	1.00	5.6/2.8	14	11.87	
1/2	3600	115/230	56J	C465	5KC39QN3218X	√	\$558	F1	1.15	7.4/3.7	19	11.9	15
3/4	3600	115/230	56C	C847	5KC37NN115X	√	\$594	F1	1.00	9.8/4.9	22	11.76	
1	3600	115/230	56J	C352	5KC49NN2135X	√	\$641	F1	1.15	13.0/6.5	27	12.95	15
2	3600	115/230	56J	C878	5KCR49TN2164T	√	\$963	F1	1.00	17.8/8.9	38	14.79	ES,1,15

CENTRIFUGAL PUMP (JET PUMP) MOTORS

THREE PHASE, TOTALLY ENCLOSED MOTORS

FEATURES:

- Service factor, as noted
- Double sealed ball bearings, mechanically locked on shaft end
- Continuous duty
- Nameplated 60/50 hertz, 190/380 volts at next lower HP, as noted
- 56C = carbon steel shaft with key
- 56J = 416 stainless steel threaded shaft with slinger
- UL recognized, CSA certified, and CE mark
- Drip cover not included, see accessories section



C-Face Footless

C-Face Footed (Rigid Base)

C-FACE FOOTLESS, 56C/56J

HP	RPM	VOLTS	FRAME	CAT. NO.	MODEL NO.	STOCK	LIST PRICE	MULT. SYMB.	SERVICE FACTOR	FL. AMPS	WT.	"C" DIM.	FOOT NOTES
1/3	3600	208-230/460	56C	KG215	5K35FN55	√	\$282	F1	1.75	1.5-1.8/0.9	14	9.90	68
	3600	208-230/460	56J	K748	5K35FN101	√	\$284	F1	1.75	1.5-1.8/0.9	14	10.40	48
1/2	3600	208-230/460	56C	K216	5K36JN57	√	\$320	F1	1.60	2.0-2.0/1.0	16	10.31	48, 68
	3600	208-230/460	56J	K217	5K36JN56	√	\$322	F1	1.60	2.0-2.0/1.0	16	10.82	48, 68
	1800	208-230/460	56J	K553	5K42HN4139	√	\$633	F1	1.25	2.3-2.2/1.1	18	10.41	48
3/4	3600	208-230/460	56C	K218	5K37MN37	√	\$386	F1	1.50	2.6-2.6/1.3	18	10.70	48, 68
	3600	208-230/460	56J	KG219	5K37MN38	√	\$387	F1	1.50	2.6-2.6/1.3	17	11.22	48, 68, d
	3600	208-230/460	56J	K1483	5K37MN3543	√	\$394	F1	1.50	2.6-2.6/1.3	17	11.22	48
	1800	208-230/460	56J	K555	5K46KN4141	√	\$744	F1	1.25	3.3-3.0/1.5	24	11.24	48
1	3600	208-230/460	56C	K220	5K38PN47	√	\$438	F1	1.40	3.3-3.2/1.6	19	11.30	48, 68
	3600	208-230/460	56J	K221	5K38PN48	√	\$440	F1	1.40	3.3-3.2/1.6	19	11.82	48, 68
	1800	208-230/460	56J	K750	5K46MN4144	√	\$770	F1	1.15	3.6-3.8/1.9	27	11.24	48
1 1/2	3600	208-230/460	56C	K222	5K46KN2173	√	\$534	F1	1.30	5.0-4.8/2.4	24	10.73	48, 68
	3600	208-230/460	56J	K223	5K46KN2172	√	\$536	F1	1.30	5.0-4.8/2.4	23	11.24	48, 68
	3600	208-230/460	56J	K1484	5K46KN2082	√	\$543	F1	1.15	5.0-4.8/2.4	24	11.24	48
	1800	208-230/460	56J	K751	5K49PN4121	√	\$849	F1	1.15	5.8-5.6/2.8	28	11.84	48
2	3600	208-230/460	56C	K224	5K49NN2180	√	\$625	F1	1.20	6.0-6.0/3.0	27	11.33	48, 68
	3600	208-230/460	56J	K225	5K49NN2178	√	\$630	F1	1.20	6.0-6.0/3.0	27	11.84	48, 68
3	3600	208-230/460	56C	K226	5K48TN2182	√	\$701	F1	1.15	8.9-8.2/4.1	38	12.61	48, 68
	3600	208-230/460	56J	K227	5K48TN2181	√	\$706	F1	1.15	8.9-8.2/4.1	38	13.12	48, 68

C-FACE FOOTED (RIGID BASE), 56J

ADDITIONAL FEATURES: Drip cover included

HP	RPM	VOLTS	FRAME	CAT. NO.	MODEL NO.	STOCK	LIST PRICE	MULT. SYMB.	SERVICE FACTOR	FL. AMPS	WT.	"C" DIM.	FOOT NOTES
1/3	3600	208-230/460	56J	J047	056T34D5368		\$292	F1	1.75	1.2-1.1/1.55	21	10.43	68
1/2	3600	208-230/460	56J	J048	056T34D5367	√	\$328	F1	1.60	2.1-2.2/1.1	21	10.93	68
3/4	3600	208-230/460	56J	J049	056T34D5365	√	\$394	F1	1.50	2.6-2.6/1.3	22	11.22	68
1	3600	208-230/460	56J	J050	056T34D5366	√	\$448	F1	1.40	3.7-3.7/1.85	23	10.93	68
1 1/2	3600	208-230/460	56J	J051	056T34D5369	√	\$543	F1	1.15	5.0-4.8/2.4	23	11.24	68
2	3600	208-230/460	56J	J052	056T34D5370	√	\$636	F1	1.20	6.4-6.2/3.1	30	10.93	68
3	3600	208-230/460	56J	J053	056T34D5371	√	\$712	F1	1.15	8.9-8.4/4.2	32	11.93	68

CENTRIFUGAL PUMP (JET PUMP) MOTORS

THREE PHASE, TOTALLY ENCLOSED MOTORS

FEATURES:

- Service factor, as noted
- Double sealed ball bearings, mechanically locked on shaft end
- Continuous duty
- Nameplated 60/50 hertz, 190/380 volts at next lower HP, as noted
- 56C = carbon steel shaft with key
- 56J = 416 stainless steel threaded shaft with slinger
- UL recognized, CSA certified, and CE mark
- Drip cover not included, see accessories section



C-Face Footless

C-FACE FOOTLESS, 56C/56J

C-Face Footed (Rigid Base)

HP	RPM	VOLTS	FRAME	CAT. NO.	MODEL NO.	STOCK	LIST PRICE	MULT. SYMB.	SERVICE FACTOR	FL. AMPS	WT.	"C" DIM.	FOOT NOTES
1/3	3600	208-230/460	56C	P101	056T34T5306	√	\$327	F1	1.35	1.7-2.0/1.0	18	9.94	N, 68
1/2	3600	208-230/460	56C	P102	056T34F5321	√	\$363	F1	1.15	2.1-2.2/1.1	21	11.82	12, 18
	3600	200-230/460	56J	K230	5K35JN47	√	\$528	F1	1.60	2.1-2.0/1.0	17	11.40	82, 18
	1800	208-230/460	56J	K550	5K42HN4133	√	\$641	F1	1.00	2.3-2.2/1.1	22	11.52	48
3/4	3600	208-230/460	56C	P103	056T34F5322	√	\$430	F1	1.15	3.0-3.2/1.6	22	11.82	68
	3600	208-230/460	56J	KG232	5K36MN339	√	\$583	F1	1.50	2.6-2.6/1.3	16	11.90	48, d
1	3600	208-230/460	56C	P104A	056T34F99009	√	\$540	F1	1.15	3.2-3.0/1.5	45	11.82	68
	3600	230/460	56J	KG234A	056T34F99023	√	\$838	F1	1.40	3.0/1.5	24	12.32	68, d
1 1/2	3600	208-230/460	56C	P105A	056T34F99032	√	\$636	F1	1.15	4.2-4.0/2.0	36	13.32	68
	3600	230/460	56J	KG236A	056T34F99031	√	\$900	F1	1.30	4.0/2.0	37	13.82	68
2	3600	230/460	56C	P106A	056T34F15600	√	\$757	F1	1.15	5.0/2.5	47	14.32	68
	3600	230/460	56J	K238A	056T34F99028	√	\$993	F1	1.25	5.0/2.5	46	14.82	68
3	3600	208-230/460	56C	P107A	056T34F15591	√	\$795	F1	1.15	8.2-7.6/3.8	45	14.32	68
	3600	230/460	56J	K240A	056T34F15597	√	\$1,071	F1	1.00	7.6/3.8	45	14.82	

C-FACE FOOTED (REMOVABLE BASE), 56J

ADDITIONAL FEATURES: Drip cover included

HP	RPM	VOLTS	FRAME	CAT. NO.	MODEL NO.	STOCK	LIST PRICE	MULT. SYMB.	SERVICE FACTOR	FL. AMPS	WT.	"C" DIM.	FOOT NOTES
1/3	3600	208-230/460	56J	J060	056T34T5308		\$359	F1	1.15	1.7-2.0/1.0	21	10.44	N, 68
1/2	3600	208-230/460	56J	J061	056T34F5342	√	\$394	F1	1.15	2.1-2.2/1.1	23	12.32	68
3/4	3600	208-230/460	56J	J062	056T34F5343	√	\$462	F1	1.15	3.0-3.2/1.6	23	12.32	68
1	3600	230/460	56J	J063A	056T34F99029	√	\$559	F1	1.15	3.0/1.5	24	12.32	68
1 1/2	3600	208-230/460	56J	J064A	056T34F99018	√	\$693	F1	1.15	4.2-4.0/2.0	39	13.82	68
2	3600	230/460	56J	J065A	056T34F15592	√	\$798	F1	1.15	5.0/2.5	49	14.82	68
3	3600	230/460	56J	J066A	056T34F15601	√	\$873	F1	1.15	7.6/3.8	48	14.82	68

COMMERCIAL PUMP MOTORS

THREE PHASE, SQUIRREL CAGE, C-FACE FOOTLESS MOTORS

APPLICATIONS:

Domestic, commercial and industrial water systems.

FEATURES:

- Mechanically locked bearing on shaft end
- 56C = keyed shaft
- 56J = 303 stainless steel threaded shaft
- Service factor, as noted
- Double sealed ball bearings
- H707ES vertical mount

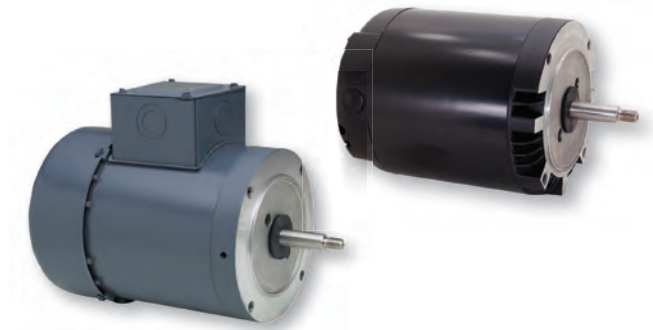

DRIPPROOF

HP	RPM	VOLTS	FRAME	CAT. NO.	MODEL NO.	STOCK	LIST PRICE	MULT. SYMB.	SERVICE FACTOR	SERVICE FACTOR AMPS	WT.	"C" DIM.	FOOT NOTES
1/2	3450/2850	208-230/460	56J	H155	Century®	√	\$464	F1	1.60	2.6-2.6/1.3	28	11.0	68, 126
3/4	3450/2850	208-230/460	56J	H446	Century	√	\$510	F1	1.50	3.4-3.4/1.7	20	11.8	68, 126
1	3450/2850	208-230/460	56J	H506	Century	√	\$587	F1	1.40	4.3-4.0/2.0	24	11.8	68, 126
1 1/2	3450/2850	230/460	56C	H609ES	Century	√	\$814	F1	1.30	4.6/2.3	25	12.5	68, 126
	3450/2850	208-230/460	56J	H607	Century	√	\$754	F1	1.30	5.8-5.6/2.8	27	12.3	68, 126
2	3450/2850	230/460	56C	H612ES	Century	√	\$1,020	F1	1.20	6.0/3.0	32	12.3	68, 126
	3450/2850	200-230/460	56J	H733	Century	√	\$901	F1	1.20	6.8-6.6/3.3	34	12.8	68, 126
3	3450	230/460	56C	H736ES	Century	√	\$1,256	F1	1.15	8.0/4.0	21	14.0	68, 126
	3450	200-230/460	56J	H734	Century	√	\$1,033	F1	1.15	9.8-9.6/4.8	33	12.8	

TEFC

HP	RPM	VOLTS	FRAME	CAT. NO.	MODEL NO.	STOCK	LIST PRICE	MULT. SYMB.	SERVICE FACTOR	SERVICE FACTOR AMPS	WT.	"C" DIM.	FOOT NOTES
3/4	3450	200-230/460	56C	H193V1	Century	√	\$676	F1	1.15	2.6-2.4/1.2	26	11.3	
	3450	200-230/460	56J	H515	Century	√	\$694	F1	1.15	2.6-2.4/1.2	26	11.9	
2	3450	230/460	56J	H706ES	Century	√	\$1,213	F1	1.15	5.8/2.9	48	12.5	
3	3450	230/460	56J	H707ES	Century	√	\$1,424	F1	1.00	8.0/4.0	48	15.5	

SPECIAL DIRECT REPLACEMENT PUMP MOTORS

CAPACITOR START, DRIPPROOF MOTORS

IMPORTANT:

Total horsepower (HP x service factor) of replacement motor must equal or exceed motor being replaced.

FEATURES:

- Auto protector
- Sealed switch design
- 56J = Internally mounted capacitor
- 303 stainless steel special threaded shafts
- Service factor, as noted
- Ball bearings
- CCW-pump end rotation
- Cap. start / cap. run as noted



VERTICAL MOUNT - ROUND FLANGE

HP	RPM	VOLTS	FRAME	CAT. NO.	MODEL NO.	STOCK	LIST PRICE	MULT. SYMB.	SERVICE FACTOR	MAX AMPS	WT.	FRAME LENGTH	STA-RITE REF.	FOOT NOTES
1/2	3450	115/230	48Y	R1052	Century®	√	\$470	F1	1.90	12.4/6.2	19	9.50	A200CH	
3/4	3450	115/230	48Y	R1072	Century	√	\$569	F1	1.65	14.8/7.4	21	10.13	A200DH	
1	3450	115/230	48Y	R1102	Century	√	\$643	F1	1.65	19.2/9.6	26	11.19	A200EH	

ROUND FLANGE - EXTENDED SHAFT

HP	RPM	VOLTS	FRAME	CAT. NO.	MODEL NO.	STOCK	LIST PRICE	MULT. SYMB.	SERVICE FACTOR	MAX AMPS	WT.	FRAME LENGTH	STA-RITE REF.	FOOT NOTES
3/4	3450	115/230	48Y	R1072ES	Century	√	\$635	F1	1.65	14.8/7.4	21	10.13	A300DH	
1	3450	115/230	48Y	R1102ES	Century	√	\$691	F1	1.65	19.2/9.6	26	11.19	A300EH	
1 1/2	3450	230	48Y	R1152ES	Century	√	\$982	F1	1.47	12.0	31	11.94	A300FH	
2	3450	230	48Y	R1202ES	Century	√	\$1,175	F1	1.30	11.5	33	11.94	AE300GH	1

SQUARE FLANGE - EXTENDED SHAFT

HP	RPM	VOLTS	FRAME	CAT. NO.	MODEL NO.	STOCK	LIST PRICE	MULT. SYMB.	SERVICE FACTOR	MAX AMPS	WT.	FRAME LENGTH	STA-RITE REF.	FOOT NOTES
3/4	3450	115/230	48Y	Q1072ES	Century	√	\$639	F1	1.65	14.8/7.4	21	13.13	A700DH	
1	3450	115/230	48Y	Q1102ES	Century	√	\$705	F1	1.65	19.2/9.6	26	13.5	A700EH	
1 1/2	3450	115/230	48Y	Q1152ES	Century	√	\$982	F1	1.47	24.0/12.0	29	12.13	A700FH	

CLOSE-COUPLED PUMP, JM MOTORS

SINGLE PHASE, DRIPPROOF MOTORS

APPLICATIONS:

Close-coupled pumps where the pump impeller is mounted directly on the motor shaft in environments that are relatively clean and dry.

FEATURES:

- NEMA® JM pump shaft dimensions
- Ball bearings, mechanically locked on shaft end
- Capacitor start design for high starting torque
- Capacitor start / capacitor run design for higher efficiency, as noted
- Continuous duty
- 1.15 service factor
- UL recognized and CSA certified



C-Face Footed

C-FACE FOOTED (RIGID BASE)

HP	RPM	VOLTS	FRAME	CAT. NO.	MODEL NO.	STOCK	LIST PRICE	MULT. SYMB.	NOM. EFF.	FL. AMPS	WT.	"C" DIM.	FOOT NOTES
1	1800	115/208-230	143JM	Z401	143TCDR5328		\$681	S2	72.0	13.4/6.8-6.7	34	13.62	
1 1/2	1800	115/208-230	145JM	Z403	145TCDR5328		\$757	S2	77.0	18.0/9.3-9.0	43	14.62	
2	3600	115/208-230	145JM	Z404	145TBDR5304		\$762	S2	78.5	19.2/10.5-9.6	36	13.62	1
	1800	115/230	182JM	Z405A	182TCDW7074	√	\$869	S2	72.0	23.0/11.5	69	16.09	13
3	3600	115/230	182JM	Z406A	182TCDW7318	√	\$964	S2	75.5	32.0/16.1	60	15.32	13
	1800	115/230	184JM	Z407A	184TCDW7047	√	\$1,127	S2	75.5	33.0/16.5	77	17.59	13
5	3600	230	184JM	Z408A	184TBDW17007	√	\$1,412	S2	80.0	22.0	93	16.32	1, 13
	1800	230	213JM	Z409	213TCDW7027	√	\$1,549	S2	78.5	28.0	115	19.92	
7 1/2	3600	230	213JM	Z410	213TCDW7002	√	\$1,763	S2	78.5	37.0	106	18.42	
	1800	230	215JM	Z411	215TBDW7029	√	\$2,140	S2	84.0	34.5	120	19.92	1
10	3600	230	215JM	Z412	215TCDW7002	√	\$2,268	S2	81.5	47.0	150	19.92	
	1800	230	215JM	Z413	215TBDW7027	√	\$2,595	S2	82.5	44.0	159	21.17	1

CLOSE-COUPLED PUMP, JM MOTORS

SINGLE PHASE, TOTALLY ENCLOSED MOTORS

APPLICATIONS:

Close-coupled pumps where the pump impeller is mounted directly on the motor shaft in damp, dusty, or dirty environments.

FEATURES:

- NEMA JM pump shaft dimensions
- Ball bearings, mechanically locked on shaft end
- Capacitor start / capacitor run design for higher efficiency, as noted
- Continuous duty
- 1.0 service factor (except as noted)
- UL recognized and CSA certified



C-FACE FOOTED (RIGID BASE)

HP	RPM	VOLTS	FRAME	CAT. NO.	MODEL NO.	STOCK	LIST PRICE	MULT. SYMB.	NOM. EFF.	FL. AMPS	WT.	"C" DIM.	FOOT NOTES
5	3600	230	184JM	Z433A	184TBFW7315	√	\$1,461	S2	82.5	19.2	89	18.59	13
7 1/2	3600	230	213JM	Z434	213TBFW7010	√	\$1,962	S2	81.5	32.0	90	20.59	
10	3600	230	215JM	Z435	215TBFW7010	√	\$2,391	S2	85.5	41.5	236	22.09	18

CLOSE-COUPLED PUMP, JP MOTORS

SINGLE PHASE, DRIPPROOF MOTORS

FEATURES:

- NEMA® JP pump shaft dimensions
- Ball bearings, mechanically locked on shaft end
- Capacitor start design for high starting torque
- Capacitor start / capacitor run design for higher efficiency, as noted
- Continuous duty
- 1.15 service factor
- UL recognized and CSA certified.



C-Face Footed

C-FACE FOOTED (RIGID BASE)

HP	RPM	VOLTS	FRAME	CAT. NO.	MODEL NO.	STOCK	LIST PRICE	MULT. SYMB.	NOM. EFF.	FL. AMPS	WT.	"C" DIM.	FOOT NOTES
1	1800	115/208-230	143JP	Z420	143TCDR5330		\$630	S2	72.0	13.4/6.8-6.7	35	16.68	95
1 1/2	1800	115/208-230	145JP	Z422	145TCDR5329		\$757	S2	77.0	18.6/9.9-9.3	43	17.68	95
2	1800	115/230	182JP	Z424	182TCDR7354		\$964	S2	72.0	23.0/11.5	78	19.15	13
3	3600	115/230	182JP	Z425	182TCDR8005		\$964	S2	74.0	32.0/16.0	87	18.65	13
	1800	115/230	184JP	Z426	184TCDR7626		\$1,412	S2	75.5	33.0/16.5	94	20.65	13
5	3600	230	184JP	Z427A	184TBDW17011	✓	\$1,412	S2	80.0	22.0	89	19.46	1, 13
	1800	230	213JP	Z428	213TCDW7028		\$1,549	S2	78.5	28.0	130	23.79	95
7 1/2	3600	230	213JP	Z429	213TCDW7003	✓	\$1,763	S2	78.5	37.0	118	22.29	95
	1800	230	215JP	Z430	215TBDW7045		\$2,140	S2	84.0	34.5	132	23.79	1, 95
10	3600	230	215JP	Z431	215TCDW7004	✓	\$2,268	S2	81.5	47.0	135	23.79	95
	1800	230	215JP	Z432	215TBDW7030		\$2,595	S2	82.5	44.0	325	25.04	1, 95

NEMA is a trademark of National Electrical Manufacturers Association. All Rights Reserved.

Prices and specifications are subject to change without notice.

CLOSE COUPLED PUMP, JM, THREE PHASE MOTORS

DRIPPROOF, C-FACE FOOTLESS (VERTICAL) AND C-FACE FOOTED (RIGID BASE) MOTORS



FEATURES:

- **Meets or exceeds all USA mandated efficiencies**

- Suitable for use on a VFD. 10:1 variable torque and 2:1 constant torque
- 1.15 service factor on sinewave, 1.0 service factor on IGBT power
- NEMA® JM pump shaft dimensions
- JMV frame (includes drip cover as noted) for vertical mount without base
- JM frame has rigid base, drip cover not included
- Ball bearings, mechanically locked on shaft end
- Class F Insulation (except as noted)

- Dual rated motors are nameplated 60/50 hertz, 190/380 volts at next lower HP
- Standard assembly F1, reversible to F2 assembly (except as noted)
- UL recognized, CSA certified and CE mark

HP	RPM	VOLTS	FRAME	CAT. NO.	MODEL NO.	STOCK	LIST PRICE	MULT. SYMB.	NOM. EFF.	FL. AMPS	WT.	"C" DIM.	FOOT NOTES
1	1800	200	143JM	GT2001	143TTDR16043	√	\$661	S2	85.5	3.45	46	15.12	13
	1800	200	143JMV	GT4001	143TTDR16042	√	\$661	S2	85.5	3.45	44	15.42	13, 27
	1800	230/460	143JM	GT0401	143TTDR6030	√	\$661	S2	85.5	3.0/1.5	45	15.12	13
	1800	208-230/460	143JMV	GT4101	143TTDR16047	√	\$661	S2	85.5	3.2-3/1.5	45	15.42	13, 27
	1800	575	143JM	GT0501	143TTDR6031	√	\$661	S2	85.5	1.2	46	15.12	13
	1800	575	143JMV	GT4201	143TTDR16039	√	\$661	S2	85.5	1.2	45	15.42	13, 27
	1200	230/460	145JM	GT0402	145TTDR16080	√	\$1,092	S2	82.5	3.8/1.9	68	15.62	13
	1200	575	145JMV	GT0502	145TTDR16081	√	\$1,092	S2	82.5	1.5	68	15.62	13
1 1/2	3600	200	143JM	GT2003	143TTDR16009	√	\$755	S2	86.5	4.4	45	14.62	13
	3600	200	143JMV	GT4003	143TTDR16012	√	\$755	S2	86.5	4.4	44	14.92	13, 27
	3600	230/460	143JM	GT0403	143TTDR6007	√	\$755	S2	86.5	3.8/1.9	43	14.62	13
	3600	230/460	143JMV	GT4103	143TTDR16013	√	\$755	S2	86.5	3.8/1.9	44	14.92	13, 27
	3600	575	143JM	GT0503	143TTDR6008	√	\$755	S2	86.5	1.5	44	14.62	13
	3600	575	143JMV	GT4203	143TTDR16007	√	\$755	S2	86.5	1.5	49	14.92	13, 27
	1800	200	145JM	GT2004	145TTDR16074	√	\$720	S2	86.5	5.05	48	15.12	13
	1800	200	145JMV	GT4004	145TTDR16073	√	\$720	S2	86.5	5.05	46	15.42	13, 27
	1800	230/460	145JM	GT0404	145TTDR6034	√	\$720	S2	86.5	4.4/2.2	46	15.12	13
	1800	230/460	145JMV	GT4104	145TTDR16329	√	\$720	S2	86.5	4.4/2.2	46	15.42	13, 27
	1800	575	145JM	GT0504	145TTDR6031	√	\$720	S2	86.5	1.8	47	15.12	13
	1800	575	143JMV	GT4204	143TTDR16046	√	\$720	S2	86.5	1.8	47	15.42	13, 27
	1200	230/460	182JM	GT0405	182TTDB6082	√	\$1,240	S2	86.5	4.4/2.2	81	16.34	
	1200	575	182JMV	GT0505	182TTDB6092	√	\$1,240	S2	86.5	1.75	84	16.34	
2	3600	200	145JM	GT2006	145TTDR16015	√	\$848	S2	86.5	6.45	32	13.12	13
	3600	200	145JMV	GT4006	145TTDR16013	√	\$848	S2	86.5	6.45	33	13.42	13, 27
	3600	230/460	145JM	GT0406	145TTDR6007	√	\$848	S2	86.5	5.6/2.8	33	13.12	13
	3600	230/460	145JMV	GT4106	145TTDR16019	√	\$848	S2	86.5	5.6/2.8	33	13.42	13, 27
	3600	575	145JM	GT0506	145TTDR6004	√	\$848	S2	86.5	2.2	32	13.12	13
	3600	575	145JMV	GT4206	145TTDR16018	√	\$848	S2	86.5	2.2	32	13.42	13, 27
	1800	200	145JM	GT2007	145TTDR16335	√	\$816	S2	86.5	6.9	50	15.62	13
	1800	200	145JMV	GT4007	145TTDR16336	√	\$816	S2	86.5	6.9	49	15.92	13, 27
	1800	230/460	145JM	GT0407	145TTDR6036	√	\$816	S2	86.5	6.0/3.0	42	15.62	13
	1800	230/460	145JMV	GT4107	145TTDR16332	√	\$816	S2	86.5	6.0/3.0	49	15.92	13, 27
	1800	575	145JM	GT0507	145TTDR6030	√	\$816	S2	86.5	2.4	50	15.62	13
	1800	575	145JMV	GT4207	145TTDR16338	√	\$816	S2	86.5	2.4	49	15.92	13, 27
	1200	230/460	184JM	GT0408	184TTDB6082	√	\$1,259	S	87.5	5.8/2.9	110	17.37	
	1200	575	184JMV	GT0508	184TTDB6092	√	\$1,259	S	87.5	2.3	94	17.37	

Catalog numbers (Cat No.) highlighted in bold blue are premium efficient.

Continued on next page.

CLOSE COUPLED PUMP, JM, THREE PHASE MOTORS

DRIPPROOF, C-FACE FOOTLESS (VERTICAL) AND
C-FACE FOOTED (RIGID BASE) MOTORS

HP	RPM	VOLTS	FRAME	CAT. NO.	MODEL NO.	STOCK	LIST PRICE	MULT. SYMB.	NOM. EFF.	FL. AMPS	WT.	"C" DIM.	FOOT NOTES	
3	3600	200	145JM	GT2009	145TTDR16023	✓	\$948	S2	87.5	8.75	48	15.12	13	
	3600	200	145JMV	GT4009	145TTDR16022	✓	\$948	S2	87.5	8.75	48	15.42	13, 27	
	3600	230/460	145JM	GT0409	145TTDR6013	✓	\$948	S2	86.5	7.2/3.6	48	14.75	13	
	3600	230/460	145JMV	GT4109	145TTDR16305	✓	\$948	S2	87.5	7.6/3.8	47	15.42	13, 27	
	3600	575	145JM	GT0509	145TTDR6006	✓	\$948	S2	87.5	3.0	40	15.12	13	
	3600	575	145JMV	GT4209	145TTDR16302	✓	\$948	S2	87.5	3.0	46	15.42	13, 27	
	1800	200	182JM	E145A	—		\$902	S2	89.5	9.4	70	17.09	BI	
	1800	200	182JMV	E147B	182TTDW16062		\$948	S2	89.5	9.2	89	14.95	13, 27	
	1800	230/460	182JM	GT0410	182TTDB6032	✓	\$902	S2	89.5	7.8/3.9	76	16.34		
	1800	230/460	182JMV	E148B	182TTDW16067		\$948	S2	89.5	8.0/4.0	75	14.95	13, 27	
	1800	575	182JM	GT0510	182TTDB6033	✓	\$902	S2	89.5	3.05	76	16.34		
	1800	575	182JMV	E149B	—		\$948	S2	89.5	3.5	87	18.28	27	
	1200	230/460	213JM	GT0411	213TTDB6082	✓	\$1,732	S2	88.5	8.8/4.4	142	19.22	d	
	1200	230/460	213JMV	GT0411A	213TTDBD6082	✓	\$1,732	S2	88.5	8.4/4.2	156	19.22		
	1200	575	213JM	GT0511	213TTDB6092	✓	\$1,732	S2	88.5	3.5	143	19.22	d	
	1200	575	213JMV	GT0511A	213TTDBD6092	✓	\$1,732	S2	88.5	3.5	156	19.22		
	5	3600	200	182JM	E150B	182TTDW16311		\$1,140	S2	86.5	13.8	65	14.82	13
		3600	200	182JMV	E152A	—		\$1,140	S2	86.5	13.8	78	16.68	27, BI
3600		230/460	182JM	M315C	182TTDW16018		\$1,140	S2	86.5	12.4/6.2	65	14.82	13	
3600		208-230/460	182JMV	M316B	182TTDW17008		\$1,140	S2	86.5	13.6-12.4	95	14.95	13, 27	
3600		230/460	182JM	GT0412	182TTDB6007	✓	\$1,140	S2	86.5	11.8/5.9	76	16.34		
3600		230/460	182JMV	E153B	182TTDW16021		\$1,140	S2	86.5	12.4/6.2	46	14.95	13, 27	
3600		575	182JM	GT0512	182TTDB6008	✓	\$1,140	S2	86.5	5.0	72	16.34		
3600		575	182JMV	E154B	182TTDW16315		\$1,140	S2	86.5	5.0	73	14.95	27	
1800		200	184JM	E155A	184TTDW16074		\$1,095	S2	89.5	14.5	94	15.82	13, BI	
1800		200	184JMV	E157B	184TTDW16072		\$1,095	S2	89.5	14.5	94	15.95	13, 27	
1800		230/460	184JM	GT0413	184TTDB6032	✓	\$1,095	S2	89.5	12.4/6.2	90	17.37		
1800		230/460	184JMV	E158B	184TTDW16073		\$1,095	S2	89.5	12.6/6.3	84	16.62	13, 27	
1800		575	184JM	GT0513	184TTDB6033	✓	\$1,095	S2	89.5	5.1	100	17.37		
1800		575	184JMV	E159A	—		\$1,095	S2	89.5	5.2	83	19.37	27, BI	
1200		230/460	215JM	GT0414	215TTDB6082	✓	\$2,016	S2	89.5	14.0/7.0	147	19.22	d	
1200		230/460	215JMV	GT0414A	215TTDBD6082	✓	\$2,016	S2	89.5	13.8/6.9	281	19.22		
1200		575	215JM	GT0514	215TTDB6092	✓	\$2,016	S2	89.5	5.6	155	19.22	d	
1200		575	215JMV	GT0514A	215TTDBD6092	✓	\$2,016	S2	89.5	5.6	281	19.22		
7 1/2	3600	200	184JM	E160A	—		\$1,367	S2	88.5	20.2	87	17.09	13, BI	
	3600	200	184JMV	E162A	—		\$1,367	S2	88.5	20.2	89	19.87	27, BI	
	3600	230/460	184JM	GT0415	184TTDB6007	✓	\$1,367	S2	88.5	17.2/8.6	89	17.37	A	
	3600	230/460	184JMV	E163B	184TTDW16310		\$1,367	S2	88.5	17.8/8.9	90	17.12	13, 27	
	3600	575	184JM	GT0515	184TTDB6008	✓	\$1,367	S2	88.5	7.2	93	17.37		
	3600	575	184JMV	E164A	—		\$1,367	S2	88.5	7.2	98	17.68	27, BI	
	1800	200	213JM	E165A	—		\$1,669	S2	91.0	22.1	118	19.16	BI	
	1800	200	213JMV	E167A	213TTDWD16347		\$1,669	S2	91.0	23.0	122	20.44	27	
	1800	230/460	213JM	GT0416	213TTDB6032	✓	\$1,669	S2	91.0	18.6/9.3	137	19.22	d	
	1800	230/460	213JMV	GT0416A	213TTDBD6032	✓	\$1,669	S2	91.0	19.8/9.9	136	17.68		
	1800	230/460	213JM	E168A	213TTDWD16333		\$1,669	S2	91.0	20.0/10.0	122	20.44	27	
	1800	575	213JM	GT0516	213TTDB6033	✓	\$1,669	S2	91.0	7.6	132	19.22		
	1800	575	213JMV	GT0516A	213TTDBD6033	✓	\$1,669	S2	91.0	7.5	166	17.68	d	
	1800	575	213JM	E169A	—		\$1,669	S2	91.0	7.7	142	20.44	27, BI	
	1200	230/460	254JM	GT0417	254TTDCA6082	✓	\$2,521	S2	90.2	21.0/10.5	303	24.41	d	
	1200	208-230/460	254JM	GT0457	254TTDBD6082	✓	\$2,521	S2	90.2	22.0-21.0/10.5	245	24.41		
	1200	575	254JM	GT0517	254TTDCA6092	✓	\$2,521	S2	90.2	8.4	302	24.41	d	
	1200	575	254JMV	GT0557	254TTDBD6092	✓	\$2,521	S2	90.2	8.1	245	24.41		

Catalog numbers (Cat No.) highlighted in bold blue are premium efficient.

Blue shaded areas are cast iron frames.

Continued on next page.

CLOSE COUPLED PUMP, JM, THREE PHASE MOTORS

DRIPPROOF, C-FACE FOOTLESS (VERTICAL) AND
C-FACE FOOTED (RIGID BASE) MOTORS

HP	RPM	VOLTS	FRAME	CAT. NO.	MODEL NO.	STOCK	LIST PRICE	MULT. SYMB.	NOM. EFF.	FL. AMPS	WT.	"C" DIM.	FOOT NOTES
10	3600	200	213JM	E170A	—		\$1,763	S2	89.5	26.9	131	19.16	BI
	3600	200	213JMV	E172A	—		\$1,763	S2	89.5	26.9	112	20.44	27, BI
	3600	230/460	213JM	GT0418	213TTDB6007	√	\$1,763	S2	89.5	23.0/11.5	126	19.22	d
	3600	208-230/460	213JM	GT0418A	213TTDBD6007	√	\$1,763	S2	89.5	24.3/12.2	180	19.22	
	3600	230/460	213JMV	E173A	213TTDWD16307		\$1,763	S2	89.5	24.2/12.1	125	18.94	27, BI
	3600	575	213JM	GT0518	213TTDB6008	√	\$1,763	S2	89.5	8.8	127	19.22	d
	3600	575	213JM	GT0518A	213TTDBD6008	√	\$1,763	S2	89.5	9.2	156	19.22	
	3600	575	213JMV	E174A	—		\$1,763	S2	89.5	9.3	125	20.44	27
	1800	200	215JM	E175A	215TTDWD16364		\$1,952	S2	91.7	30.0	124	19.16	
	1800	200	215JMV	E177A	—		\$1,952	S2	91.7	28.7	128	20.44	27, BI
	1800	230/460	215JM	GT0419	215TTDB6032	√	\$1,952	S2	91.7	24.4/12.2	155	19.22	d
	1800	230/460	215JM	GT0419A	215TTDBD6032	√	\$1,952	S2	91.7	25.4/12.7	185	19.22	
	1800	230/460	215JMV	E178A	215TTDWD16349		\$1,952	S2	91.7	26.2/13.1	134	20.44	27, BI
	1800	575	215JM	GT0519	215TTDB6033	√	\$1,952	S2	91.7	10.0	160	19.22	d
	1800	575	215JM	GT0519A	215TTDBD6033	√	\$1,952	S2	91.7	9.8	229	19.22	
	1800	575	215JMV	E179A	—		\$1,952	S2	91.7	10.0	118	20.44	13, 27, BI
	1200	230/460	256JM	GT0420	256TTDCA6082	√	\$3,143	S2	91.7	27.6/13.8	348	25.99	d
	1200	208-230/460	256JM	GT0458	256TTDBD6082	√	\$3,143	S2	91.7	25.6/12.8	285	25.99	
	1200	575	256JM	GT0520	256TTDCA6092	√	\$3,143	S2	91.7	11.0	349	25.99	d
	1200	575	256JM	GT0558	256TTDBD6092	√	\$3,143	S2	91.7	10.3	285	25.99	
15	3600	200	215JM	E180	215TTDW4008		\$1,850	S2	90.2	39.0	128	20.41	13
	3600	200	215JMV	E182	215TTDW4010		\$2,027	S2	90.2	39.0	160	21.69	13, 27
	3600	230/460	215JM	E113	215TTDW4022	√	\$1,850	S2	90.2	34.0/17.0	131	20.41	d, 13
	3600	230/460	215JM	E113A	215TTDWD4022	√	\$1,850	S2	90.2	36.5/18.2	131	19.16	13
	3600	230/460	215JMV	E183	215TTDW4023	√	\$2,027	S2	90.2	34.0/17.0	162	21.69	d, 13, 27
	3600	230/460	215JMV	E183A	215TTDWD4023	√	\$2,027	S2	90.2	36.5/18.2	162	20.44	13, 27
	3600	230/460	215JM	GT0421	215TTDB6007	√	\$2,177	S2	90.2	34.0/17.0	140	19.22	d
	3600	208-230/460	215JM	GT0421A	215TTDBD6007	√	\$2,177	S2	90.2	36.0/18.0	135	19.22	
	3600	575	215JM	GT0521	215TTDB6008	√	\$2,177	S2	90.2	13.5	157	19.22	d
	3600	575	215JM	GT0521A	215TTDBD6008	√	\$2,177	S2	90.2	13.6	191	19.22	
	3600	575	215JM	E181	215TTDW4009		\$1,850	S2	90.2	13.6	159	20.41	BI
	3600	575	215JMV	E184	215TTDW4007		\$2,027	S2	90.2	13.6	127	21.69	27, BI
	1800	200	254JM	E185A	—		\$2,623	S2	93.0	44.0	268	24.17	BI
	1800	200	254JMV	E187A	—		\$2,623	S2	93.0	44.2	263	25.45	27, BI
	1800	230/460	254JM	E114B	254TTDR16031		\$2,623	S2	93.0	38.0/18.9	270	23.60	13
	1800	230/460	254JMV	E188A	254TTDR16027		\$2,623	S2	93.0	38.0/18.9	284	25.45	27, BI
	1800	230/460	254JM	GT0422	254TTDCA6032	√	\$2,623	S2	93.0	37.0/18.5	333	24.41	d
	1800	208-230/460	254JM	GT0459	254TTDBD6032	√	\$2,623	S2	93.0	37.5/18.8	288	24.41	
	1800	575	254JM	E186A	—		\$2,623	S2	93.0	15.3	200	24.17	BI
	1800	575	254JM	GT0522	254TTDCA6033	√	\$2,623	S2	93.0	15.2	325	24.41	d
1800	575	254JM	GT0559	254TTDBD6033	√	\$2,623	S2	93.0	15.1	288	24.41		
1200	230/460	284JM	GT0423	284TTDCA6082	√	\$4,139	S2	91.7	40.0/20.0	482	26.58	d	
1200	208-230/460	284JM	GT0460	284TTDBD6082	√	\$4,139	S2	91.7	41.0/20.6	399	26.58		
1200	575	284JM	GT0523	284TTDCA6092	√	\$4,139	S2	91.7	16.0	478	26.58	d	
1200	575	284JM	GT0560	284TTDBD6092	√	\$4,139	S2	91.7	16.5	399	26.58		
20	3600	200	254JM	E190	254TTDX4007		\$2,335	S2	91.0	53.1	204	24.17	BI
	3600	200	254JMV	E193	254TTDX4015		\$2,590	S2	91.0	53.1	185	23.70	27, BI
	3600	230/460	254JM	E191	254TTDX4006		\$2,335	S2	91.0	46.0/23.1	213	22.42	
	3600	230/460	254JMV	E194	254TTDX4020		\$2,590	S2	91.0	46.0/23.1	187	23.70	27, BI
	3600	230/460	254JM	GT0424	254TTDCA6007	√	\$2,717	S2	91.0	46.5/23.3	313	24.41	d
	3600	208-230/460	254JM	GT0461	254TTDBD6007	√	\$2,717	S2	91.0	48.0/24.0	284	24.41	
	3600	575	254JM	GT0524	254TTDCA6008	√	\$2,717	S2	91.0	18.5	310	24.41	d
	3600	575	254JM	GT0561	254TTDBD6008	√	\$2,717	S2	91.0	19.2	284	24.41	
	3600	575	254JM	E192	254TTDX4019		\$2,335	S2	91.0	18.5	225	22.42	BI
	3600	575	254JMV	E195	254TTDX4024		\$2,590	S2	91.0	18.5	178	23.70	27, BI

Catalog numbers (Cat No.) highlighted in bold blue are premium efficient.
Blue shaded areas are cast iron frames.

Continued on next page.

CLOSE COUPLED PUMP, JM, THREE PHASE MOTORS

DRIPPROOF, C-FACE FOOTLESS (VERTICAL) AND
C-FACE FOOTED (RIGID BASE) MOTORS

HP	RPM	VOLTS	FRAME	CAT. NO.	MODEL NO.	STOCK	LIST PRICE	MULT. SYMB.	NOM. EFF.	FL. AMPS	WT.	"C" DIM.	FOOT NOTES	
20	1800	200	256JMV	E199A	—		\$3,221	S2	93.0	60.0	235	25.45	27, BI	
	1800	230/460	256JM	E197A	256TTDR16026		\$3,221	S2	93.0	49.0/24.5	260	21.89	BI	
	1800	230/460	256JMV	U100A	—		\$3,221	S2	93.0	50.0/25.0	196	25.45	27, BI	
	1800	230/460	256JM	GT0425	256TTDCA6032	✓	\$3,221	S2	93.0	48.0/24.0	369	26.00	d	
	1800	208-230/460	256JM	GT0462	256TTDBD6032	✓	\$3,221	S2	93.0	53.0-49.0/24.5	325	25.99		
	1800	575	256JM	GT0525	256TTDCA6033	✓	\$3,221	S2	93.0	19.5	365	26.00	d	
	1800	575	256JM	GT0562	256TTDBD6033	✓	\$3,221	S2	93.0	19.5	325	25.99		
	1800	575	256JM	E198A	—		\$3,221	S2	93.0	20.8	238	24.17	BI	
	1800	575	256JMV	U101A	—		\$3,221	S2	93.0	20.8	188	25.45	27, BI	
	1200	230/460	286JMV	GT0426	286TTDCA6082	✓	\$5,044	S2	92.4	54.0/27.0	529	27.09	d	
	1200	208-230/460	286JM	GT0463	286TTDBD6082	✓	\$5,044	S2	92.4	52.5/26.3	405	27.09		
	1200	575	286JM	GT0526	286TTDCA6092	✓	\$5,044	S2	92.4	21.6	538	27.09	d	
	1200	575	286JM	GT0563	286TTDBD6092	✓	\$5,044	S2	92.4	21.1	405	27.09		
	25	3600	200	256JM	U102A	—		\$3,221	S2	91.7	66.5	225	24.17	BI
3600		230/460	256JM	U103A	256TTDR16008		\$3,221	S2	91.7	57.0/28.5	294	23.60	BI	
3600		230/460	256JM	GT0427	256TTDCA6007	✓	\$3,286	S2	91.7	56.0/28.0	350	26.00	d	
3600		208-230/460	256JM	GT0464	256TTDBD6007	✓	\$3,286	S2	91.7	59.5/29.7	297	25.99		
3600		575	256JM	GT0527	256TTDCA6008	✓	\$3,286	S2	91.7	22.8	335	26.00	d	
3600		575	256JM	GT0564	256TTDBD6008	✓	\$3,286	S2	91.7	23.8	298	25.99		
3600		575	256JM	U104A	—		\$3,221	S2	91.7	23.2	196	24.17	BI	
1800		208	284JM	U105A	284TTDN16059		\$3,844	S2	93.6	68.5	358	25.89		
1800		230/460	284JM	GT0428	284TTDCA6032	✓	\$3,844	S2	93.6	62.0/31.0	509	26.58	d	
1800		208-230/460	284JM	GT0465	284TTDBD6032	✓	\$3,844	S2	93.6	62.0/31.0	411	26.58		
1800		575	284JM	GT0528	284TTDCA6033	✓	\$3,844	S2	93.6	25.0	512	26.58	d	
1800		575	284JM	GT0565	284TTDBD6033	✓	\$3,844	S2	93.6	24.8	411	26.58		
1200		230/460	324JM	GT0429	324TTDCA6082	✓	\$6,008	S2	93.0	68.0/34.0	625	28.94	d	
1200		208-230/460	324JM	GT0468	324TTDBD6082	✓	\$6,008	S2	93.0	65.0/32.5	635	28.94		
1200		575	324JM	GT0529	324TTDCA6092	✓	\$6,008	S2	93.0	27.2	618	28.94	d	
1200		575	324JM	GT0568	324TTDBD6092	✓	\$6,008	S2	93.0	25.9	635	28.94		
30		3600	200	284JM	U108A	284TTDN16009		\$3,924	S2	91.7	78.0	295	25.89	
		3600	230/460	284JM	GT0430	284TTDCA6007	✓	\$3,924	S2	91.7	66.5/33.5	518	26.58	d
	3600	208-230/460	284JM	GT0469	284TTDBD6007	✓	\$3,924	S2	91.7	71.5/35.5	378	26.58		
	3600	575	284JM	GT0530	284TTDCA6008	✓	\$3,924	S2	91.7	27.2	586	26.58	d	
	3600	575	284JM	GT0569	284TTDBD6008	✓	\$3,924	S2	91.7	28.6	378	26.58		
	1800	200	286JM	U111A	286TTDN16331		\$4,440	S2	94.1	85.0	410	27.76		
	1800	230/460	286JM	GT0431	286TTDCA6032	✓	\$4,440	S2	94.1	73.0/36.5	544	27.10	d	
	1800	208-230/460	286JM	GT0467	286TTDBD6032	✓	\$4,440	S2	94.1	72.5/36	479	27.09		
	1800	575	286JM	GT0531	286TTDCA6033	✓	\$4,440	S2	94.1	29.5	705	27.10	d	
	1800	575	286JM	GT0567	286TTDBD6033	✓	\$4,440	S2	94.1	29.0	479	27.09		
	1200	230/460	326JM	GT0432	326TTDCA6082	✓	\$7,038	S2	93.6	81.0/40.5	741	30.12	d	
	1200	208-230/460	326JM	GT0471	326TTDBD6082	✓	\$7,038	S2	93.6	75.0/37.5	734	30.12		
	1200	575	326JM	GT0532	326TTDCA6092	✓	\$7,036	S2	93.6	32.5	727	30.12	d	
	1200	575	326JM	GT0571	326TTDBD6092	✓	\$7,038	S2	93.6	30.0	734	30.12		
	40	3600	230/460	286JM	GT0433	286TTDCA6007	✓	\$4,912	S2	92.4	89.0/44.5	555	27.10	d
		3600	208-230/460	286JM	GT0472	286TTDBD6007	✓	\$4,912	S2	92.4	93.0/46.5	419	27.09	
3600		575	286JM	GT0533	286TTDCA6008	✓	\$4,912	S2	92.4	36.0	555	27.10	d	
3600		575	286JM	GT0572	286TTDBD6008	✓	\$4,912	S2	92.4	37.5	419	27.09		
1800		230/460	324JM	GT0434	324TTDCA6032	✓	\$5,801	S2	94.1	95.0/47.5	645	28.94	d	
1800		208-230/460	324JM	GT0473	324TTDBD6032	✓	\$5,801	S2	94.1	95.5/48	584	28.94		
1800		575	324JM	GT0534	324TTDCA6033	✓	\$5,801	S2	94.1	38.0	649	28.94	d	
1800		575	324JM	GT0573	324TTDBD6033	✓	\$5,801	S2	94.1	38.5	584	28.94		
50		3600	230/460	324JM	GT0436	324TTDCA6007	✓	\$6,284	S2	93.0	111.0/55.5	680	28.94	d
	3600	208-230/460	324JM	GT0476	324TTDBD6007	✓	\$6,284	S2	93.0	115/57.5	525	28.94		
	3600	575	324JM	GT0536	324TTDCA6008	✓	\$6,284	S2	93.0	37.0	675	28.94	d	
	3600	575	324JM	GT0576	324TTDBD6008	✓	\$6,284	S2	93.0	46.0	525	28.94		
	1800	230/460	326JM	GT0437	326TTDCA6032	✓	\$6,702	S2	94.5	118.0/59	689	30.12	d	
	1800	208-230/460	326JM	GT0477	326TTDBD6032	✓	\$6,702	S2	94.5	118/59	691	30.12		
	1800	575	326JM	GT0537	326TTDCA6033	✓	\$6,702	S2	94.5	47.0	695	30.12	d	
	1800	575	326JM	GT0577	326TTDBD6033	✓	\$6,702	S2	94.5	47.0	691	30.12		

Catalog numbers (Cat No.) highlighted in bold blue are premium efficient.

Blue shaded areas are cast iron frames.

CLOSE-COUPLED PUMP, JM, THREE PHASE MOTORS

TEFC, C-FACE FOOTLESS (VERTICAL) AND C-FACE FOOTED (RIGID BASE) MOTORS

FEATURES:

- Meets or exceeds all USA mandated efficiencies
- IP55 rating, enclosure protection against dust and water jets, as noted
- Hazardous Duty® motors division 2 UL certification nameplate, as noted
- Division 2 / zone 2 class 1 (gases), groups A, B, C, D
- NEMA® JM pump shaft dimensions
- JMV frame (includes drip cover as noted) for vertical mount without base
- JM frame has rigid base, drip cover not included
- Suitable for use on a VFD. 10:1 variable torque and 2:1 constant torque
- 1.15 service factor on sinewave, 1.0 service factor on IGBT power (except as noted)
- Dual rated motors are nameplated 60/50 hertz, 190/380 volts at next lower HP



- Class F Insulation
- Ball bearings, mechanically locked on shaft end
- Standard assembly F1, reversible to F2 assembly (except as noted)
- UL recognized, CSA certified and CE mark

HP	RPM	VOLTS	FRAME	IP55	DIV II	CAT. NO.	MODEL NO.	STOCK	LIST PRICE	MULT. SYMB.	NOM. EFF.	FL. AMPS	WT.	"C" DIM.	FOOT NOTES	
1	3600	208-230/460	143JM	N	N	CPE12	Century®	✓	\$688	S2	77.0	3.2-2.9/1.4	62	15.75		
	1800	200	143JM	N	N	GT3001	143TTFR16047	✓	\$854	S2	85.5	3.8	48	16.00	13	
	1800	200	143JMV	N	N	GT5001	143TTFR16048	✓	\$843	S2	85.5	3.8	43	16.79	13	
	1800	230/460	143JM	N	N	GT3101	143TTFR16032	✓	\$854	S2	85.5	3.2/1.6	45	15.42	13	
	1800	208-230/460	143JM	N	N	CPE10	Century	✓	\$854	S2	85.5	3.1-2.8/1.4	62	15.75		
	1800	230/460	143JMV	N	N	GT5101	143TTFR16052	✓	\$843	S2	85.5	3.3/1.65	43	16.79	13	
	1800	575	143JMV	N	N	GT5201	143TTFR16042	✓	\$843	S2	85.5	1.3	43	16.00	13	
	1800	575	143JM	N	N	GT3201	143TTFR16046	✓	\$854	S2	85.5	1.3	47	16.00	13	
	1200	230/460	145JM	N	N	GT3102	145TTFR16083	✓	\$1,313	S2	82.5	3.8/1.9	59	17.00	13	
	1200	575	145JM	N	N	GT3202	145TTFR16085	✓	\$1,313	S2	82.5	1.5	62	17.00	13	
	1 1/2	3600	200	143JM	N	N	GT3003	143TTFR16007	✓	\$1,004	S2	84.0	4.6	40	15.49	13
		3600	200	143JMV	N	N	GT5003	143TTFR16005	✓	\$991	S2	84.0	4.6	50	15.49	13
3600		230/460	143JM	N	N	GT3103	143TTFR16010	✓	\$1,004	S2	84.0	4.0/2.0	41	15.49	13	
3600		208-230/460	143JM	N	N	CPE16	Century	✓	\$1,004	S2	84.0	4.4-4/2	67	15.75		
3600		230/460	143JMV	N	N	GT5103	143TTFR16006	✓	\$991	S2	84.0	4.0/2.0	50	15.49	13	
3600		575	143JM	N	N	GT3203	143TTFR16013	✓	\$1,004	S2	84.0	1.6	41	15.49	13	
3600		575	143JMV	N	N	GT5203	143TTFR16004	✓	\$991	S2	84.0	1.6	39	15.49	13	
1800		200	145JM	N	N	GT3004	145TTFR16059	✓	\$936	S2	86.5	5.3	46	16.50	13	
1800		200	145JMV	N	N	GT5004	145TTFR16058	✓	\$924	S2	86.5	5.3	45	17.29	13	
1800		230/460	145JM	N	N	GT3104	145TTFR16036	✓	\$936	S2	86.5	4.8/2.4	46	15.92	13	
1800		208-230/460	145JM	N	N	CPE14	Century	✓	\$936	S2	86.5	4.5-4/2	69	16.75		
1800		230/460	145JMV	N	N	GT5104	145TTFR16074	✓	\$924	S2	86.5	4.6/2.3	45	17.29	13	
1800		575	145JM	N	N	GT3204	145TTFR16063	✓	\$936	S2	86.5	1.9	46	16.50	13	
1800		575	145JMV	N	N	GT5204	145TTFR16062	✓	\$924	S2	86.5	1.9	49	17.29	13	
1200		230/460	182JM	N	N	GT3105	182TTFB6082	✓	\$1,439	S2	87.5	4.6/2.3	103	17.51		
1200		575	182JM	N	N	GT3205	182TTFB6092	✓	\$1,439	S2	87.5	1.9	101	17.51		
2		3600	200	145JM	N	N	GT3006	145TTFR16010	✓	\$1,087	S2	85.5	5.8	50	16.50	13
		3600	200	145JMV	N	N	GT5006	145TTFR16009	✓	\$1,074	S2	85.5	5.8	50	17.29	13
	3600	230/460	145JM	N	N	GT3106	145TTFR16013	✓	\$1,087	S2	85.5	5.0/2.5	50	16.50	13	
	3600	208-230/460	145JM	N	N	CPE20	Century	✓	\$1,087	S2	85.5	5.6-5.1/2.5	67	16.75		
	3600	230/460	145JMV	N	N	GT5106	145TTFR16012	✓	\$1,074	S2	85.5	5.0/2.5	49	17.29	13	
	3600	575	145JM	N	N	GT3206	145TTFR16018	✓	\$1,087	S2	85.5	2.0	50	16.50	13	
	3600	575	145JMV	N	N	GT5206	145TTFR16017	✓	\$1,074	S2	85.5	2.0	47	17.29	13	

Catalog numbers (Cat No.) highlighted in bold blue are premium efficient.
Blue shaded areas are cast iron frames.

Continued on next page.

PUMP MOTORS

CLOSE-COUPLED PUMP, JM, THREE PHASE MOTORS

TEFC, C-FACE FOOTLESS (VERTICAL) AND C-FACE FOOTED (RIGID BASE) MOTORS

HP	RPM	VOLTS	FRAME	IP55	DIV II	CAT. NO.	MODEL NO.	STOCK	LIST PRICE	MULT. SYMB.	NOM. EFF.	FL. AMPS	WT.	"C" DIM.	FOOT NOTES	
2	1800	200	145JM	N	N	GT3007	145TTFR16067	√	\$979	S2	86.5	6.9	55	17.00	13	
	1800	200	145JMV	N	N	GT5007	145TTFR16066	√	\$966	S2	86.5	6.9	49	17.79	13	
	1800	230/460	145JM	N	N	GT3107	145TTFR16037	√	\$979	S2	86.5	5.8/2.9	54	16.42	13	
	1800	208-230/460	145JM	N	N	CPE18	Century®	√	\$979	S2	86.5	5.8-5.2/2.6	67	16.75		
	1800	230/460	145JMV	N	N	GT5107	145TTFR16057	√	\$966	S2	86.5	6.0/3.0	50	17.79	13	
	1800	575	145JM	N	N	GT3207	145TTFR16071	√	\$979	S2	86.5	2.4	50	17.00	13	
	1800	575	145JMV	N	N	GT5207	145TTFR16070	√	\$966	S2	86.5	2.4	49	17.79	13	
	1200	230/460	184JM	N	N	GT3108	184TTFB6082	√	\$1,505	S2	88.5	6.0/3.0	114	18.36		
	1200	575	184JM	N	N	GT3208	184TTFB6092	√	\$1,505	S2	88.5	2.4	121	18.36		
3	3600	230/460	145JM	N	N	U363A	145TTFR16106	√	\$1,138	S2	86.5	7.6/3.8	48	16.50		
	3600	200	182JM	N	N	U315A	—		\$1,246	S2	86.5	8.5	81	17.35	13	
	3600	230/460	182JM	N	N	GT3109	182TTFB6006	√	\$1,246	S2	86.5	8.0/4.0	75	17.51		
	3600	208-230/460	182JM	N	N	CPE24	Century	√	\$1,246	S2	86.5	8.4-7.6/3.8	98	17.53		
	3600	575	182JM	N	N	GT3209	182TTFB6008	√	\$1,246	S2	86.5	3.0	91	17.51		
	1800	230/460	182JM	N	N	GT3110	182TTFB6031	√	\$1,140	S2	89.5	7.8/3.9	95	17.51		
	1800	208-230/460	182JM	N	N	CPE22	Century	√	\$1,140	S2	89.5	8.8-7.9/4	98	17.53		
	1800	575	182JM	N	N	GT3210	182TTFB6033	√	\$1,140	S2	89.5	3.1	105	17.51		
	1200	230/460	213JM	N	N	GT3111	213TTFB6082	√	\$1,753	S2	89.5	8.6/4.3	156	20.65	d	
	1200	230/460	213JM	N	N	GT3111A	213TTFBD6082	√	\$1,753	S2	89.5	8.6/4.3	152	20.27		
	1200	575	213JM	N	N	GT3211	213TTFB6092	√	\$1,753	S2	89.5	3.5	156	20.65	d	
	1200	575	213JM	N	N	GT3211A	213TTFBD6092	√	\$1,753	S2	89.5	3.5	152	20.27		
	5	3600	230/460	184JM	N	N	GT3112	184TTFB6006	√	\$1,479	S2	88.5	11.6/5.8	95	18.36	
3600		208-230/460	184JM	N	N	CPE28	Century	√	\$1,479	S2	88.5	14-12/6.2	105	18.52		
3600		575	184JM	N	N	GT3212	184TTFB6008	√	\$1,479	S2	88.5	4.8	150	18.36		
1800		230/460	184JM	N	N	GT3113	184TTFB6031	√	\$1,377	S2	89.5	12.4/6.2	100	18.36		
1800		208-230/460	184JM	N	N	CPE26	Century	√	\$1,377	S2	89.5	14-13/6.5	105	18.52		
1800		575	184JM	N	N	GT3213	184TTFB6033	√	\$1,377	S2	89.5	5.0	119	18.36		
1200		230/460	215JM	N	N	GT3114	215TTFB6082	√	\$2,118	S2	89.5	14.0/7.0	179	20.65	d	
1200		230/460	215JM	N	Y	GT3114A	215TTFBD6082	√	\$2,118	S2	89.5	13.6/6.8	167	21.85		
1200		575	215JM	N	N	GT3214	215TTFB6092	√	\$2,118	S2	89.5	5.6	158	20.65	d	
1200		575	215JM	N	Y	GT3214A	215TTFBD6092	√	\$2,118	S2	89.5	5.5	167	21.85		
7 1/2		3600	230/460	184JM	N	N	U360A	184TTFW16015	√	\$1,678	S2	89.5	17.6/8.8	103	18.09	13, 17
		3600	200	213JM	N	N	U327A	213TTFWD16014		\$1,846	S2	89.5	21.4	149	20.59	
	3600	230/460	213JM	N	N	GT3115	213TTFB6006	√	\$1,846	S2	89.5	17.8/8.9	144	20.65	d	
	3600	230/460	213JM	N	Y	GT3115A	213TTFBD6006	√	\$1,846	S2	89.5	18.4/9.2	140	20.27		
	3600	208-230/460	213JM	N	N	CPE32	Century	√	\$1,846	S2	89.5	21-19/9.3	170	19.78		
	3600	575	213JM	N	N	GT3215	213TTFB6008	√	\$1,846	S2	89.5	7.2	144	20.65	d	
	3600	575	213JM	N	Y	GT3215A	213TTFBD6008	√	\$1,846	S2	89.5	7.4	140	20.27		
	3600	575	213JM	N	N	CPE34	Century	√	\$1,846	S2	89.5	7.5	170	19.78		
	1800	230/460	213JM	N	N	GT3116	213TTFB6031	√	\$2,110	S2	91.7	18.6/9.3	163	20.65	d	
	1800	230/460	213JM	N	Y	GT3116A	213TTFBD6031	√	\$2,110	S2	91.7	19.0/9.5	160	20.27		
	1800	208-230/460	213JM	N	N	CPE30	Century	√	\$2,110	S2	91.7	22.0-20.0/9.8	175	19.78		
	1800	575	213JM	N	N	GT3216	213TTFB6033	√	\$2,110	S2	91.7	7.7	163	20.65	d	
	1800	575	213JM	N	Y	GT3216A	213TTFBD6033	√	\$2,110	S2	91.7	7.6	160	20.27		
	1200	230/460	254JM	N	N	GT3117	254TTFCA6082	√	\$3,662	S2	91.0	21.0/10.5	325	26.60	d	
	1200	230/460	254JM	Y	Y	GT3117A	254TTFCD6082	√	\$3,662	S2	91.0	19.8/9.9	320	26.15		
	1200	575	254JM	N	N	GT3217	254TTFCA6092	√	\$3,662	S2	91.0	8.4	324	26.60	d	
	1200	575	254JM	Y	Y	GT3217A	254TTFCD6092	√	\$3,662	S2	91.0	7.9	320	26.15		
	10	3600	200	215JM	N	N	U336A	215TTFWD16011		\$2,257	S2	90.2	27.2	165	22.09	
3600		230/460	215JM	N	N	GT3118	215TTFB6006	√	\$2,257	S2	90.2	23.0/11.5	162	20.65	d	
3600		230/460	215JM	N	Y	GT3118A	215TTFBD6006	√	\$2,257	S2	90.2	23.6/11.8	170	21.85		
3600		208-230/460	215JM	N	N	CPE37	Century	√	\$2,257	S2	90.2	26.0-24.0/12.0	175	21.35		
3600		575	215JM	N	N	GT3218	215TTFB6008	√	\$2,257	S2	90.2	9.2	172	20.65	d	
3600		575	215JM	N	Y	GT3218A	215TTFBD6008	√	\$2,257	S2	90.2	9.5	170	21.85		
3600		208-230/460	215JM	N	N	CPE39	Century	√	\$2,257	S2	90.2	9.5	175	21.35		

Catalog numbers (Cat No.) highlighted in bold blue are premium efficient.

Blue shaded areas are cast iron frames.

Continued on next page.

CLOSE-COUPLED PUMP, JM, THREE PHASE MOTORS

TEFC, C-FACE FOOTLESS (VERTICAL) AND C-FACE FOOTED (RIGID BASE) MOTORS

HP	RPM	VOLTS	FRAME	IP55	DIV II	CAT. NO.	MODEL NO.	STOCK	LIST PRICE	MULT. SYMB.	NOM. EFF.	FL. AMPS	WT.	"C" DIM.	FOOT NOTES
10	1800	200	215JM	N	N	U339A	—	✓	\$2,525	S2	91.7	29.9	130	22.09	
	1800	230/460	215JM	N	N	GT3119	215TTFB6031	✓	\$2,525	S2	91.7	24.4/12.2	250	20.65	d
	1800	230/460	215JM	N	Y	GT3119A	215TTFBD6031	✓	\$2,525	S2	91.7	25.0/12.5	185	21.85	
	1800	208-230/460	215JM	N	N	CPE35	Century®	✓	\$2,525	S2	91.7	28.0-25.0/13.0	200	21.35	
	1800	575	215JM	N	N	GT3219	215TTFB6033	✓	\$2,525	S2	91.7	10.3	184	20.65	d
	1800	575	215JM	N	Y	GT3219A	215TTFBD6033	✓	\$2,525	S2	91.7	10.0	185	21.85	
	1200	230/460	256JM	N	N	GT3120	256TTFCA6082	✓	\$4,474	S2	91.0	28.0/14.0	349	27.80	d
	1200	230/460	256JM	Y	Y	GT3120A	256TTFCD6082	✓	\$4,474	S2	91.0	25.8/12.9	341	27.89	
	1200	575	256JM	N	N	GT3220	256TTFCA6092	✓	\$4,474	S2	91.0	11.2	357	27.80	d
1200	575	256JM	Y	Y	GT3220A	256TTFCD6092	✓	\$4,474	S2	91.0	10.3	341	27.89		
15	3600	230/460	215JM	N	N	U357A	215TTFWD16013	✓	\$2,301	S2	91.0	35.0/17.6	165	23.34	
	3600	230/460	254JM	N	N	U344A	254TTFL16008		\$2,781	S2	91.0	36.0/18.0	302	25.52	AL
	3600	230/460	254JM	N	N	GT3121	254TTFCA6006	✓	\$2,821	S2	91.0	34.0/17.0	359	26.60	d
	3600	230/460	254JM	Y	Y	GT3121A	254TTFCD6006	✓	\$2,821	S2	91.0	35.5/17.8	342	26.15	
	3600	575	254JM	N	N	GT3221	254TTFCA6008	✓	\$2,821	S2	91.0	14.0	338	26.60	d
	3600	575	254JM	Y	Y	GT3221A	254TTFCD6008	✓	\$2,821	S2	91.0	14.3	342	26.15	
	3600	575	254JM	N	N	U346A	254TTFL16011		\$2,781	S2	91.0	14.4	302	25.52	AL
	1800	200	254JM	N	N	U347A	—		\$3,291	S2	92.4	46.0	225	24.74	AL
	1800	230/460	254JM	N	N	U348A	254TTFL16045		\$3,291	S2	92.4	37.5/18.8	251	25.52	AL
	1800	230/460	254JM	N	N	GT3122	254TTFCA6031	✓	\$3,422	S2	92.4	37.0/18.5	345	26.60	d
	1800	230/460	254JM	Y	Y	GT3122A	254TTFCD6031	✓	\$3,422	S2	92.4	37.5/18.8	340	26.15	
	1800	575	254JM	N	N	GT3222	254TTFCA6033	✓	\$3,422	S2	92.4	15.0	352	26.60	d
	1800	575	254JM	Y	Y	GT3222A	254TTFCD6033	✓	\$3,422	S2	92.4	15.1	340	26.15	
	1800	575	254JM	N	N	U349A	254TTFL16043		\$3,291	S2	92.4	15.1	355	25.52	AL
	1200	230/460	284JM	N	N	GT3123	284TTFCA6082	✓	\$5,938	S2	91.7	41.0/20.5	498	30.92	d
	1200	230/460	284JM	Y	Y	GT3123A	284TTFCD6082	✓	\$5,938	S2	91.7	40.0/20.0	472	27.52	
	1200	575	284JM	N	N	GT3223	284TTFCA6092	✓	\$5,938	S2	91.7	16.4	499	30.92	d
	1200	575	284JM	Y	Y	GT3223A	284TTFCD6092	✓	\$5,938	S2	91.7	16.0	472	27.52	
20	3600	200	256JM	N	N	U350A	—		\$3,843	S2	91.0	54.1	232	26.49	AL
	3600	230/460	256JM	N	N	U351A	256TTFL16004	✓	\$3,843	S2	91.0	47.0/23.4	272	27.27	AL
	3600	230/460	256JM	N	N	GT3124	256TTFCA6006	✓	\$3,326	S2	91.0	46.5/23.2	373	27.80	d
	3600	230/460	256JM	Y	Y	GT3124A	256TTFCD6006	✓	\$3,326	S2	91.0	47.5/23.7	368	27.89	
	3600	575	256JM	N	N	GT3224	256TTFCA6008	✓	\$3,326	S2	91.0	18.5	373	27.80	d
	3600	575	256JM	Y	Y	GT3224A	256TTFCD6008	✓	\$3,326	S2	91.0	19.0	368	27.89	
	3600	575	256JM	N	N	U352A	—		\$3,843	S2	91.0	18.8	232	26.49	AL
	1800	200	256JM	N	N	U353B	256TTFL16041		\$3,702	S2	93.0	55.5	324	27.27	AL
	1800	230/460	256JM	N	N	U354A	256TTFL16042	✓	\$3,702	S2	93.0	48.0/24.1	230	27.27	AL
	1800	230/460	256JM	N	N	GT3125	256TTFCA6031	✓	\$3,884	S2	93.0	48.5/24.2	450	27.80	d
	1800	230/460	256JM	Y	Y	GT3125A	256TTFCD6031	✓	\$3,884	S2	93.0	48.5/24.2	410	27.89	
	1800	575	256JM	N	N	GT3225	256TTFCA6033	✓	\$3,884	S2	93.0	19.4	423	27.80	d
	1800	575	256JM	Y	Y	GT3225A	256TTFCD6033	✓	\$3,884	S2	93.0	19.4	410	27.89	
	1800	575	256JM	N	N	U355A	—		\$3,702	S2	93.0	20.4	321	28.49	AL
	1200	230/460	286JM	N	N	GT3126	286TTFCA6082	✓	\$7,236	S2	91.7	52.0/26.0	514	32.10	d
	1200	230/460	286JM	Y	Y	GT3126A	286TTFCD6082	✓	\$7,236	S2	91.7	52.0/26.0	509	29.02	
	1200	575	286JM	N	N	GT3226	286TTFCA6092	✓	\$7,236	S2	91.7	21.0	527	32.10	d
	1200	575	286JM	Y	Y	GT3226A	286TTFCD6092	✓	\$7,236	S2	91.7	20.8	509	29.02	
25	3600	230/460	284JM	N	N	GT3127	284TTFCA6006	✓	\$3,798	S2	91.7	56.0/28.1	500	30.92	d
	3600	230/460	284JM	Y	Y	GT3127A	284TTFCD6006	✓	\$3,798	S2	91.7	60.0/30.0	489	27.52	
	3600	575	284JM	N	N	GT3227	284TTFCA6008	✓	\$3,798	S2	91.7	22.2	500	30.92	d
	3600	575	284JM	Y	Y	GT3227A	284TTFCD6008	✓	\$3,798	S2	91.7	24.0	489	27.52	
	1800	230/460	284JM	N	N	GT3128	284TTFCA6032	✓	\$4,153	S2	93.6	61.0/30.5	521	30.92	d
	1800	230/460	284JM	Y	Y	GT3128A	284TTFCD6032	✓	\$4,153	S2	93.6	61.0/30.5	515	27.52	
	1800	575	284JM	N	N	GT3228	284TTFCA6033	✓	\$4,153	S2	93.6	24.5	518	30.92	d
	1800	575	284JM	Y	Y	GT3228A	284TTFCD6033	✓	\$4,153	S2	93.6	24.3	515	27.52	
	1200	230/460	324JM	N	N	GT3129	324TTFCA6082	✓	\$8,770	S2	93.0	67.0/33.5	647	32.93	d
	1200	230/460	324JM	Y	Y	GT3129A	324TTFCD6082	✓	\$8,770	S2	93.0	67.0/33.5	647	32.93	
	1200	575	324JM	N	N	GT3229	324TTFCA6092	✓	\$8,770	S2	93.0	26.8	645	32.93	d
	1200	575	324JM	Y	Y	GT3229A	324TTFCD6092	✓	\$8,770	S2	93.0	26.8	645	32.93	

Catalog numbers (Cat No.) highlighted in bold blue are premium efficient.

Blue shaded areas are cast iron frames.

Continued on next page..

CLOSE-COUPLED PUMP, JM, THREE PHASE MOTORS

TEFC, C-FACE FOOTLESS (VERTICAL) AND C-FACE FOOTED (RIGID BASE) MOTORS

HP	RPM	VOLTS	FRAME	IP55	DIV II	CAT. NO.	MODEL NO.	STOCK	LIST PRICE	MULT. SYMB.	NOM. EFF.	FL. AMPS	WT.	"C" DIM.	FOOT NOTES
30	3600	230/460	286JM	N	N	GT3130	286TTFCA6006	√	\$3,972	S2	91.7	67.0/33.5	550	32.10	d
	3600	230/460	286JM	Y	Y	GT3130A	286TTFCD6006	√	\$3,972	S2	91.7	71.0/35.5	540	29.02	
	3600	575	286JM	N	N	GT3230	286TTFCA6008	√	\$3,972	S2	91.7	27.2	513	32.10	d
	3600	575	286JM	Y	Y	GT3230A	286TTFCD6008	√	\$3,972	S2	91.7	28.5	540	29.02	
	1800	230/460	286JM	N	N	GT3131	286TTFCA6032	√	\$4,488	S2	93.6	73.0/36.5	650	32.10	d
	1800	230/460	286JM	Y	Y	GT3131A	286TTFCD6032	√	\$4,488	S2	93.6	72.5/36.5	615	29.02	
	1800	575	286JM	N	N	GT3231	286TTFCA6033	√	\$4,488	S2	93.6	29.2	548	32.10	d
	1800	575	286JM	Y	Y	GT3231A	286TTFCD6033	√	\$4,488	S2	93.6	29.1	615	29.02	
	1200	230/460	326JM	N	N	GT3132	326TTFCA6082	√	\$10,100	S2	93.0	81.0/40.5	692	34.11	d
	1200	230/460	326JM	Y	Y	GT3132A	326TTFCD6082	√	\$10,100	S2	93.0	81.0/40.5	692	34.11	
	1200	575	326JM	N	N	GT3232	326TTFCA6092	√	\$10,100	S2	93.0	32.0	690	34.11	d
	1200	575	326JM	Y	Y	GT3232A	326TTFCD6092	√	\$10,100	S2	92.4	32.0	690	34.11	
40	3600	230/460	324JM	N	N	GT3133	324TTFCA6007	√	\$4,976	S2	92.4	90.5/45.5	650	32.93	d
	3600	230/460	324JM	Y	Y	GT3133A	324TTFCD6007	√	\$4,976	S2	92.4	90.5/45.5	650	32.93	
	3600	575	324JM	N	N	GT3233	324TTFCA6008	√	\$4,976	S2	92.4	36.0	495	32.93	d
	3600	575	324JM	Y	Y	GT3233A	324TTFCD6008	√	\$4,976	S2	92.4	36.0	495	32.93	
	1800	230/460	324JM	N	N	GT3134	324TTFCA6031	√	\$5,865	S2	94.1	95.0/47.5	689	32.93	d
	1800	230/460	324JM	Y	Y	GT3134A	324TTFCD6031	√	\$5,865	S2	94.1	95.0/47.5	689	32.93	
	1800	575	324JM	N	N	GT3234	324TTFCA6033	√	\$5,865	S2	94.1	37.5	681	32.93	d
	1800	575	324JM	Y	Y	GT3234A	324TTFCD6033	√	\$5,865	S2	94.1	37.5	681	32.93	
50	3600	230/460	326JM	N	N	GT3136	326TTFCA6007	√	\$6,364	S2	93.0	111.0/55.5	750	34.11	d
	3600	230/460	326JM	Y	Y	GT3136A	326TTFCD6007	√	\$6,364	S2	93.0	111.0/55.5	750	34.11	
	3600	575	326JM	N	N	GT3236	326TTFCA6008	√	\$6,364	S2	93.0	44.5	729	34.11	d
	3600	575	326JM	Y	Y	GT3236A	326TTFCD6008	√	\$6,364	S2	93.0	44.5	729	34.11	
	1800	230/460	326JM	N	N	GT3137	326TTFCA6031	√	\$6,781	S2	94.5	119.0/59.5	724	34.11	d
	1800	230/460	326JM	Y	Y	GT3137A	326TTFCD6031	√	\$6,781	S2	94.5	119.0/59.5	724	34.11	
	1800	575	326JM	N	N	GT3237	326TTFCA6033	√	\$6,781	S2	94.5	47.5	734	34.11	d
	1800	575	326JM	Y	Y	GT3237A	326TTFCD6033	√	\$6,781	S2	94.5	47.5	734	34.11	

Catalog numbers (Cat No.) highlighted in bold blue are premium efficient.

Blue shaded areas are cast iron frames.

CLOSE-COUPLED PUMP, JP, THREE PHASE MOTORS

DRIPPROOF, C-FACE FOOTLESS (VERTICAL) AND C-FACE FOOTED (RIGID BASE) MOTORS

FEATURES:

- Meets or exceeds all USA mandated efficiencies
- Suitable for use on a VFD. 10:1 variable torque and 2:1 constant torque
- 1.15 service factor on sinewave, 1.0 service factor on IGBT power
- NEMA® JP pump shaft dimensions
- JMV frame (includes drip cover as noted) for vertical mount without base
- JM frame has rigid base, drip cover not included
- Ball bearings, mechanically locked on shaft end
- Class F Insulation (except as noted)



- Dual rated motors are nameplated 60/50 hertz, 190/380 volts at next lower HP
- Standard assembly F1, reversible to F2 assembly (except as noted)
- UL recognized, CSA certified and CE mark

HP	RPM	VOLTS	FRAME	CAT. NO.	MODEL NO.	STOCK	LIST PRICE	MULT. SYMB.	NOM. EFF.	FL. AMPS	WT.	"C" DIM.	FOOT NOTES	
1	1800	200	143JP	GT2301	143TTDR16044	✓	\$661	S2	85.5	3.5	46	18.18	13	
	1800	200	143JPV	GT4301	143TTDR16045	✓	\$661	S2	85.5	3.5	53	18.48	13, 27	
	1800	230/460	143JP	GT2401	143TTDR16048	✓	\$661	S2	85.5	3.0/1.5	46	18.18	13	
	1800	230/460	143JPV	GT4401	143TTDR16049	✓	\$661	S2	85.5	3.0/1.5	45	18.48	13, 27	
	1800	575	143JP	GT2501	143TTDR16040	✓	\$661	S2	85.5	1.2	45	18.18	13	
	1800	575	143JPV	GT4501	143TTDR16041	✓	\$661	S2	85.5	1.2	47	18.48	13, 27	
	1200	230/460	145JP	GT2402	145TTDR16079	✓	\$1,092	S2	82.5	3.8/1.9	35	18.68	13	
	1200	575	145JP	GT2502	145TTDR16082	✓	\$1,092	S2	82.5	1.5	41	18.68	13	
	1 1/2	3600	200	143JP	GT2303	143TTDR16010	✓	\$755	S2	86.5	4.4	45	17.68	13
		3600	200	143JPV	GT4303	143TTDR16011	✓	\$755	S2	86.5	4.4	44	17.98	13, 27
3600		230/460	143JP	GT2403	143TTDR16015	✓	\$755	S2	86.5	3.8/1.9	46	17.68	13	
3600		230/460	143JPV	GT4403	143TTDR16014	✓	\$755	S2	86.5	3.8/1.9	46	17.98	13, 27	
3600		575	143JP	GT2503	143TTDR16006	✓	\$755	S2	86.5	1.5	46	17.68	13	
3600		575	143JPV	GT4503	143TTDR16008	✓	\$755	S2	86.5	1.5	45	17.98	13, 27	
1800		200	145JP	GT2304	145TTDR16075	✓	\$720	S2	86.5	5.1	48	18.18	13	
1800		200	145JPV	GT4304	145TTDR16326	✓	\$720	S2	86.5	5.1	50	18.48	13, 27	
1800		230/460	145JP	GT2404	145TTDR16330	✓	\$720	S2	86.5	4.4/2.2	48	18.18	13	
1800		230/460	145JPV	GT4404	145TTDR16331	✓	\$720	S2	86.5	4.4/2.2	47	18.48	13, 27	
1800		575	145JP	GT2504	145TTDR16327	✓	\$720	S2	86.5	1.8	47	18.18	13	
1800		575	145JPV	GT4504	145TTDR16328	✓	\$720	S2	86.5	1.8	50	18.48	13, 27	
1200		230/460	182JP	GT2405	182TTDB6085	✓	\$1,240	S2	86.5	4.4/2.2	80	19.07		
1200		575	182JP	GT2505	182TTDB6095	✓	\$1,240	S2	86.5	1.8	85	19.44		
2		3600	200	145JP	GT2306	145TTDR16014	✓	\$848	S2	86.5	6.5	34	16.18	13
		3600	200	145JPV	GT4306	145TTDR16307	✓	\$848	S2	86.5	6.5	38	16.48	13, 27
	3600	230/460	145JP	GT2406	145TTDR16020	✓	\$848	S2	86.5	5.6/2.8	34	16.18	13	
	3600	230/460	145JPV	GT4406	145TTDR16021	✓	\$848	S2	86.5	5.6/2.8	34	16.48	13, 27	
	3600	575	145JP	GT2506	145TTDR16017	✓	\$848	S2	86.5	2.2	35	16.18	13	
	3600	575	145JPV	GT4506	145TTDR16016	✓	\$848	S2	86.5	2.3	33	16.48	13, 27	
	1800	200	145JP	GT2307	145TTDR16337	✓	\$816	S2	86.5	6.9	53	18.68	13	
	1800	200	145JPV	GT4307	145TTDR16342	✓	\$816	S2	86.5	6.9	35	18.98	13, 27	
	1800	230/460	145JP	GT2407	145TTDR16333	✓	\$816	S2	86.5	6.0/3.0	53	18.68	13	
	1800	230/460	145JPV	GT4407	145TTDR16334	✓	\$816	S2	86.5	6.0/3.0	52	18.98	13, 27	
	1800	575	145JP	GT2507	145TTDR16339	✓	\$816	S2	86.5	2.4	53	18.68	13	
	1800	575	145JPV	GT4507	145TTDR16340	✓	\$816	S2	86.5	2.4	52	18.98	13, 27	
	1200	230/460	184JP	GT2408	184TTDB6085	✓	\$1,259	S2	87.5	5.8/2.9	90	20.05		
	1200	575	184JP	GT2508	184TTDB6095	✓	\$1,259	S2	87.5	2.3	95	20.46		
3	3600	200	145JP	GT2309	145TTDR16024	✓	\$948	S2	87.5	8.8	49	18.18	13	
	3600	200	145JPV	GT4309	145TTDR16025	✓	\$948	S2	87.5	8.8	48	18.48	13, 27	
	3600	230/460	145JP	GT2409	145TTDR16301	✓	\$948	S2	87.5	7.6/3.8	49	18.18	13	
	3600	230/460	145JPV	GT4409	145TTDR16306	✓	\$948	S2	87.5	7.6/3.8	48	18.48	13, 27	
	3600	575	145JP	GT2509	145TTDR16303	✓	\$948	S2	87.5	3.0	49	18.18	13	
	3600	575	145JPV	GT4509	145TTDR16304	✓	\$948	S2	87.5	3.0	52	18.48	13, 027	

Catalog numbers (Cat No.) highlighted in bold blue are premium efficient.

Continued on next page..

CLOSE-COUPLED PUMP, JP, THREE PHASE MOTORS

DRIPPROOF, C-FACE FOOTLESS (VERTICAL) AND
C-FACE FOOTED (RIGID BASE) MOTORS

HP	RPM	VOLTS	FRAME	CAT. NO.	MODEL NO.	STOCK	LIST PRICE	MULT. SYMB.	NOM. EFF.	FL. AMPS	WT.	"C" DIM.	FOOT NOTES	
3	1800	200	182JP	U158A	—		\$902	S2	90.2	9.4	51	19.66	13, BI	
	1800	200	182JPV	U161A	—		\$948	S2	90.2	9.4	52	19.91	27, BI	
	1800	230/460	182JP	GT2410	182TTDB6037	√	\$902	S2	90.2	7.6/3.8	90	19.44		
	1800	230/460	182JPV	U162B	—		\$948	S2	90.2	8.8/4.4	85	18.01	27	
	1800	575	182JP	GT2510	182TTDB6038	√	\$902	S2	90.2	3.1	90	19.44		
	1800	575	182JPV	U163A	—		\$948	S2	90.2	3.5	102	19.91	27, BI	
	1200	230/460	213JP	GT2411	213TTDB6085	√	\$1,732	S2	88.5	8.8/4.4	150	23.11	d	
	1200	230/460	213JP	GT2411A	213TTDBD6085	√	\$1,732	S2	88.5	8.4/4.2	139	23.11		
	1200	575	213JP	GT2511	213TTDB6095	√	\$1,732	S2	88.5	3.5	151	23.11	d	
	1200	575	213JP	GT2511A	213TTDBD6095	√	\$1,732	S2	88.5	3.5	151	23.11		
	5	3600	200	182JP	U164A	—		\$1,140	S2	86.5	13.8	78	19.16	BI
		3600	200	182JPV	U167A	—		\$1,140	S2	86.5	13.8	81	19.84	27, BI
3600		230/460	182JP	GT2412	182TTDB6012	√	\$1,140	S2	87.5	12.4/6.2	67	19.44		
3600		230/460	182JPV	U168	182TTDR4113		\$1,140	S2	86.5	12.0/6.0	85	21.94	27, BI	
3600		575	182JP	U166	182TTDR4124		\$1,140	S2	86.5	4.8	76	19.16	BI	
3600		575	182JP	GT2512	182TTDB6013	√	\$1,140	S2	87.5	5.0	95	19.44		
3600		575	182JPV	U169	182TTDR4125		\$1,140	S2	86.5	4.8	72	21.94	27, BI	
1800		200	184JP	U170A	—		\$1,095	S2	89.5	14.5	74	20.41	13, BI	
1800		200	184JPV	U173A	—		\$1,095	S2	89.5	14.5	72	20.84	27, BI	
1800		230/460	184JP	GT2413	184TTDB6037	√	\$1,095	S2	89.5	12.8/6.4	95	20.46		
1800		208-230/460	184JPV	U299A	—		\$1,095	S2	89.5	14.5-13.2/6.6	87	19.84	13, 27	
1800		575	184JP	GT2513	184TTDB6038	√	\$1,095	S2	89.5	5.1	100	20.46		
1800		575	184JPV	U175A	—		\$1,095	S2	89.5	5.0	72	20.84	27, BI	
1200		230/460	215JP	GT2414	215TTDB6085	√	\$2,016	S2	89.5	14.0/7.0	159	23.11	d	
1200		230/460	215JP	GT2414A	215TTDBD6085	√	\$2,016	S2	89.5	13.8/6.9	158	23.11		
1200		575	215JP	GT2514	215TTDB6095	√	\$2,016	S2	89.5	5.6	147	23.11	d	
1200		575	215JP	GT2514A	215TTDBD6095	√	\$2,016	S2	89.5	5.6	147	23.11		
7 1/2		3600	200	184JP	U176A	—		\$1,367	S2	88.5	20.7	72	20.16	BI
	3600	200	184JPV	U179A	—		\$1,367	S2	88.5	20.2	72	20.84	27, BI	
	3600	230/460	184JP	GT2415	184TTDB6012	√	\$1,367	S2	88.5	17.2/8.6	90	20.46		
	3600	230/460	184JPV	U180A	—		\$1,367	S2	88.5	17.6/8.8	131	20.32	27, BI	
	3600	575	184JP	GT2515	184TTDB6013	√	\$1,367	S2	88.5	7.2	79	20.46		
	3600	575	184JPV	U181A	—		\$1,367	S2	88.5	7.2	136	20.32	27, BI	
	1800	200	213JP	U182A	—		\$1,669	S2	91.7	22.1	137	23.03	BI	
	1800	200	213JPV	U185A	213TTDWD16345		\$1,669	S2	91.0	23.0	145	25.00	27	
	1800	230/460	213JP	GT2416	213TTDB6037	√	\$1,669	S2	91.7	19.0/9.5	140	23.11	d	
	1800	230/460	213JP	GT2416A	213TTDBD6037	√	\$1,669	S2	91.7	19.8/9.9	153	23.11		
	1800	230/460	213JPV	U186B	—		\$1,669	S2	91.7	19.4/9.2	141	23.03	27	
	1800	575	213JP	GT2516	213TTDB6038	√	\$1,669	S2	91.7	7.6	140	23.11	d	
	1800	575	213JP	GT2516A	213TTDBD6038	√	\$1,669	S2	91.7	7.6	140	23.11		
	1800	575	213JPV	U187A	—		\$1,669	S2	91.7	7.7	140	24.31	27, BI	
	1200	230/460	254JP	GT2417	254TTDCA6085	√	\$2,521	S2	90.2	21.0/10.5	313	27.32	d	
	1200	230/460	254JP	GT2457	254TTDBD6085	√	\$2,521	S2	90.2	20.2/10.1	299	27.32		
	1200	575	254JP	GT2517	254TTDCA6095	√	\$2,521	S2	90.2	8.4	315	27.32	d	
	1200	575	254JP	GT2557	254TTDBD6095	√	\$2,521	S2	90.2	8.1	299	27.32		
10	3600	200	213JP	U188A	—		\$1,763	S2	89.5	26.9	130	23.03	BI	
	3600	200	213JPV	U191A	—		\$1,763	S2	89.5	26.9	130	24.31	27, BI	
	3600	230/460	213JP	GT2418	213TTDB6012	√	\$1,763	S2	89.5	23.0/11.5	140	23.11	d	
	3600	230/460	213JP	GT2418A	213TTDBD6012	√	\$1,763	S2	89.5	24.3/12.2	158	23.11		
	3600	230/460	213JPV	U192A	—		\$1,763	S2	89.5	23.4/11.7	134	24.31	27, BI	
	3600	575	213JP	GT2518	213TTDB6013	√	\$1,763	S2	89.5	9.1	150	23.11	d	
	3600	575	213JP	GT2518A	213TTDBD6013	√	\$1,763	S2	89.5	9.1	150	23.11		
	3600	575	213JPV	U193A	—		\$1,763	S2	89.5	9.3	130	24.31	27, BI	

Catalog numbers (Cat No.) highlighted in bold blue are premium efficient.

Blue shaded areas are cast iron frames.

Continued on next page..

CLOSE-COUPLED PUMP, JP, THREE PHASE MOTORS

DRIPPROOF, C-FACE FOOTLESS (VERTICAL) AND
C-FACE FOOTED (RIGID BASE) MOTORS

HP	RPM	VOLTS	FRAME	CAT. NO.	MODEL NO.	STOCK	LIST PRICE	MULT. SYMB.	NOM. EFF.	FL. AMPS	WT.	"C" DIM.	FOOT NOTES	
10	1800	200	215JP	U194A	—		\$1,952	S2	91.7	28.8	156	23.03	BI	
	1800	200	215JPV	U197A	—		\$1,952	S2	91.7	28.8	163	24.31	13, 27, BI	
	1800	230/460	215JP	GT2419	215TTDB6037	✓	\$1,952	S2	91.7	25.6/12.8	150	23.11	d	
	1800	230/460	215JP	GT2419A	215TTDBD6037	✓	\$1,952	S2	91.7	25.4/12.7	153	23.11		
	1800	208-230/460	215JPV	U198B	—		\$1,952	S2	91.7	28.0-25.0/12.5	225	24.38	27, BI	
	1800	575	215JP	GT2519	215TTDB6038	✓	\$1,952	S2	91.7	10.3	147	23.11	d	
	1800	575	215JP	GT2519A	215TTDBD6038	✓	\$1,952	S2	91.7	10.3	147	23.11		
	1800	575	215JPV	U199A	—		\$1,952	S2	91.7	10.0	137	24.31	13, 27, BI	
	1200	230/460	256JP	GT2420	256TTDCA6085	✓	\$3,143	S2	91.7	27.6/13.8	358	28.90	d	
	1200	230/460	256JP	GT2458	256TTDBD6085	✓	\$3,143	S2	91.7	25.6/12.8	315	28.90		
	1200	575	256JP	GT2520	256TTDCA6095	✓	\$3,143	S2	91.7	11.0	370	28.90	d	
	1200	575	256JP	GT2558	256TTDBD6095	✓	\$3,143	S2	91.7	10.3	315	28.90		
	15	3600	200	215JP	U200	215TTDW4011		\$1,850	S2	90.2	39.0	138	24.28	13, BI
		3600	200	215JPV	U203A	—		\$2,027	S2	90.2	39.1	139	25.56	13, 27, BI
3600		230/460	215JP	U201A	215TTDW14020	✓	\$1,850	S2	90.2	34.0/17.0	151	24.28	d	
3600		230/460	215JP	U201B	215TTDWD14020	✓	\$1,850	S2	90.2	36.5/18.2	145	21.53		
3600		230/460	215JPV	U204	215TTDW4025		\$2,027	S2	90.2	34.0/17.0	135	25.56	27, BI	
3600		230/460	215JP	GT2421	215TTDB6012	✓	\$2,177	S2	91.0	35.0/17.5	130	23.11	d	
3600		230/460	215JP	GT2421A	215TTDBD6012	✓	\$2,177	S2	91.0	36.0/18.0	165	23.11		
3600		575	215JP	GT2521	215TTDB6013	✓	\$2,177	S2	90.2	13.6	150	23.11	d	
3600		575	215JP	GT2521A	215TTDBD6013	✓	\$2,177	S2	90.2	13.6	150	23.11		
3600		575	215JPV	U205A	—		\$2,177	S2	90.2	13.6	215	25.56	13, 27, BI	
1800		200	254JP	U206A	—		\$2,623	S2	93.0	44.0	220	27.04		
1800		200	254JPV	U209A	254TTDX16055		\$2,623	S2	93.0	44.0	210	28.63	27	
1800		230/460	254JP	U207A	254TTDR16026	✓	\$2,623	S2	93.0	38.0/18.9	284	26.48	BI	
1800		230/460	254JPV	U210A	254TTDR16028	✓	\$2,623	S2	93.0	38.0/18.9	290	27.92	27	
1800		230/460	254JP	GT2422	254TTDCA6037	✓	\$2,623	S2	93.0	36.5/18.3	400	27.32	d	
1800		230/460	254JP	GT2459	254TTDBD6037	✓	\$2,623	S2	93.0	37.5/18.8	380	27.32		
1800		575	254JP	GT2522	254TTDCA6038	✓	\$2,623	S2	93.0	14.7	350	27.32	d	
1800		575	254JP	GT2559	254TTDBD6038	✓	\$2,623	S2	93.0	15.1	380	27.32		
1800		575	254JP	U208A	—		\$2,623	S2	93.0	15.4	260	27.04	13	
1800		575	254JPV	U211A	—		\$2,623	S2	93.0	15.4	220	28.33	27, BI	
1200		230/460	284JP	GT2423	284TTDCA6085	✓	\$4,139	S2	91.7	40.0/20.0	489	29.48	d	
1200		230/460	284JP	GT2460	284TTDBD6085	✓	\$4,139	S2	91.7	41.0/20.6	465	29.53		
1200		575	284JP	GT2523	284TTDCA6095	✓	\$4,139	S2	91.7	16.0	502	29.48	d	
1200		575	284JP	GT2560	284TTDBD6095	✓	\$4,139	S2	91.7	16.5	465	29.53		
20		3600	200	254JP	U212	254TTDX4014		\$2,335	S2	91.0	53.0	200	25.29	BI
		3600	200	254JPV	U215	254TTDX4010		\$2,590	S2	91.0	53.0	200	26.58	27, BI
		3600	230/460	254JP	U213	254TTDX4017		\$2,335	S2	91.0	46.0/23.1	213	25.29	
		3600	230/460	254JPV	U216	254TTDX4012		\$2,590	S2	91.0	46.0/23.1	150	26.58	27, BI
		3600	230/460	254JP	GT2424	254TTDCA6012	✓	\$2,717	S2	91.0	46.0/23.0	500	27.32	d
		3600	230/460	254JP	GT2461	254TTDBD6012	✓	\$2,717	S2	91.0	48.0/24.0	475	27.32	
	3600	575	254JP	GT2524	254TTDCA6013	✓	\$2,717	S2	91.0	18.5	400	29.48	d	
	3600	575	254JP	GT2561	254TTDBD6013	✓	\$2,717	S2	91.0	19.2	475	27.32		
	3600	575	254JP	U214	254TTDX4008		\$2,335	S2	91.0	18.5	203	25.29	BI	
	3600	575	254JPV	U217	254TTDX4016		\$2,590	S2	91.0	18.5	200	26.58	27, BI	
	1800	200	256JP	U218A	—		\$3,221	S2	93.0	60.0	225	27.04	BI	
	1800	200	256JPV	U221A	—		\$3,221	S2	93.0	59.8	235	28.33	27	
	1800	230/460	256JP	U219A	256TTDR16031	✓	\$3,221	S2	93.6	49.0/24.5	328	27.48		
	1800	230/460	256JP	GT2425	256TTDCA6037	✓	\$3,221	S2	93.0	48.0/24.0	400	28.90	d	
	1800	230/460	256JP	GT2462	256TTDBD6037	✓	\$3,221	S2	93.0	48.5/24.3	375	28.90		
	1800	575	256JP	GT2525	256TTDCA6038	✓	\$3,221	S2	93.0	19.2	400	28.90	d	
	1800	575	256JP	GT2562	256TTDBD6038	✓	\$3,221	S2	93.0	19.5	375	28.90		
	1800	575	256JP	U220A	—		\$3,221	S2	93.0	20.8	136	27.04	BI	
	1800	575	256JPV	U223A	—		\$3,221	S2	93.0	20.8	220	28.33	13, 27, BI	
	1200	230/460	286JP	GT2426	286TTDCA6085	✓	\$5,044	S2	92.4	54.0/27.0	539	29.99	d	
	1200	230/460	286JP	GT2463	286TTDBD6085	✓	\$5,044	S2	92.4	52.5/26.3	515	30.91		
	1200	575	286JP	GT2526	286TTDCA6095	✓	\$5,044	S2	92.4	21.6	544	29.99	d	
	1200	575	286JP	GT2563	286TTDBD6095	✓	\$5,044	S2	92.4	21.1	515	30.91		

Catalog numbers (Cat No.) highlighted in bold blue are premium efficient.

Blue shaded areas are cast iron frames.

Continued on next page.

CLOSE-COUPLED PUMP, JP, THREE PHASE MOTORS

DRIPPROOF, C-FACE FOOTLESS (VERTICAL) AND
C-FACE FOOTED (RIGID BASE) MOTORS

HP	RPM	VOLTS	FRAME	CAT. NO.	MODEL NO.	STOCK	LIST PRICE	MULT. SYMB.	NOM. EFF.	FL. AMPS	WT.	"C" DIM.	FOOT NOTES	
25	3600	200	256JP	U224A	—		\$3,221	S2	91.7	66.7	235	27.04		
	3600	230/460	256JP	U225A	256TTDR16004	√	\$3,221	S2	91.7	57.0/28.5	200	27.48		
	3600	230/460	256JP	GT2427	256TTDCA6012	√	\$3,286	S2	91.7	57.0/28.5	350	28.90	d	
	3600	230/460	256JP	GT2464	256TTDBD6012	√	\$3,286	S2	91.7	59.5/29.7	325	28.90		
	3600	575	256JP	GT2527	256TTDCA6013	√	\$3,286	S2	91.7	22.8	400	28.90	d	
	3600	575	256JP	GT2564	256TTDBD6013	√	\$3,286	S2	91.7	23.8	325	28.90		
	3600	575	256JP	U226A	—		\$3,221	S2	91.7	23.2	255	27.04	Bl	
	1800	200	284JP	U227A	284TTDN16060		\$3,844	S2	93.6	71.5	420	28.76		
	1800	230/460	284JP	GT2428	284TTDCA6037	√	\$3,844	S2	93.6	62.0/31.0	550	29.48	d	
	1800	230/460	284JP	GT2465	284TTDBD6037	√	\$3,844	S2	93.6	62.0/31.0	500	29.53		
	1800	575	284JP	GT2528	284TTDCA6038	√	\$3,844	S2	93.6	25.0	485	29.48	d	
	1800	575	284JP	GT2565	284TTDBD6038	√	\$3,844	S2	93.6	24.8	500	29.53		
	1200	230/460	324JP	GT2429	324TTDCA6085	√	\$6,008	S2	93.0	68.0/34.0	632	31.82	d	
	1200	230/460	324JP	GT2468	324TTDBD6085	√	\$6,008	S2	93.0	65.0/32.5	598	31.82		
	1200	575	324JP	GT2529	324TTDCA6095	√	\$6,008	S2	93.0	27.2	627	31.82	d	
	1200	575	324JP	GT2568	324TTDBD6095	√	\$6,008	S2	93.0	25.9	598	31.82		
30	3600	200	284JP	U230A	284TTDN16008		\$3,924	S2	93.6	78.0	380	28.76		
	3600	230/460	284JP	GT2430	284TTDCA6012	√	\$3,924	S2	91.7	66.5/33.5	500	29.48	d	
	3600	230/460	284JP	GT2469	284TTDBD6012	√	\$3,924	S2	91.7	71.5/35.5	472	29.53		
	3600	575	284JP	GT2530	284TTDCA6013	√	\$3,924	S2	91.7	27.2	550	29.48	d	
	3600	575	284JP	GT2569	284TTDBD6013	√	\$3,924	S2	91.7	28.6	472	29.53		
	1800	200	286JP	U233A	286TTDN16332		\$4,440	S2	94.1	85.0	350	28.76		
	1800	230/460	286JP	GT2431	286TTDCA6037	√	\$4,440	S2	94.1	74.0/37.0	500	29.99	d	
	1800	230/460	286JP	GT2467	286TTDBD6037	√	\$4,440	S2	94.1	72.5/36.0	489	30.91		
	1800	575	286JP	GT2531	286TTDCA6038	√	\$4,440	S2	94.1	29.5	600	29.99	d	
	1800	575	286JP	GT2567	286TTDBD6038	√	\$4,440	S2	94.1	29.0	489	30.91		
	1200	230/460	326JP	GT2432	326TTDCA6085	√	\$7,038	S2	93.6	81.0/40.5	745	33.00	d	
	1200	230/460	326JP	GT2471	326TTDBD6085	√	\$7,038	S2	93.6	75.0/37.5	688	33.00		
	1200	575	326JP	GT2532	326TTDCA6095	√	\$7,036	S2	93.6	32.5	737	33.00	d	
	1200	575	326JP	GT2571	326TTDBD6095	√	\$7,038	S2	93.6	30.0	688	33.00		
	40	3600	230/460	286JP	GT2433	286TTDCA6012	√	\$4,912	S2	92.4	89.0/44.5	600	29.99	d
		3600	230/460	286JP	GT2472	286TTDBD6012	√	\$4,912	S2	92.4	93.0/46.5	588	30.91	
3600		575	286JP	GT2533	286TTDCA6013	√	\$4,912	S2	92.4	35.5	500	29.99	d	
3600		575	286JP	GT2572	286TTDBD6013	√	\$4,912	S2	92.4	37.5	588	30.91		
1800		230/460	324JP	GT2434	324TTDCA6037	√	\$5,801	S2	94.5	95.0/47.5	700	31.82	d	
1800		230/460	324JP	GT2473	324TTDBD6037	√	\$5,801	S2	94.5	95.5/48.0	649	31.82		
1800		575	324JP	GT2534	324TTDCA6038	√	\$5,801	S2	94.5	38.0	700	31.82	d	
1800		575	324JP	GT2573	324TTDBD6038	√	\$5,801	S2	94.5	38.5	649	31.82		
50		3600	230/460	324JP	GT2436	324TTDCA6012	√	\$6,284	S2	93.0	93.0/46.5	700	31.82	d
	3600	230/460	324JP	GT2476	324TTDBD6012	√	\$6,284	S2	93.0	115/57.5	676	31.82		
	3600	575	324JP	GT2536	324TTDCA6013	√	\$6,284	S2	93.0	37.0	700	31.82	d	
	3600	575	324JP	GT2576	324TTDBD6013	√	\$6,284	S2	93.0	46.0	676	31.82		
	1800	230/460	326JP	GT2437	326TTDCA6037	√	\$6,702	S2	94.5	118.0/59.0	710	33.00	d	
	1800	230/460	326JP	GT2477	326TTDBD6037	√	\$6,702	S2	94.5	118/59.0	700	33.00		
	1800	575	326JP	GT2537	326TTDCA6038	√	\$6,702	S2	94.5	47.0	750	33.00	d	
	1800	575	326JP	GT2577	326TTDBD6038	√	\$6,702	S2	94.5	47.0	700	33.00		

Catalog numbers (Cat No.) highlighted in bold blue are premium efficient.

Blue shaded areas are cast iron frames.

CLOSE-COUPLED PUMP, JP, THREE PHASE MOTORS

TEFC, C-FACE FOOTLESS (VERTICAL) AND C-FACE FOOTED (RIGID BASE) MOTORS

FEATURES:

- Meets or exceeds all USA mandated efficiencies
- IP55 rating, enclosure protection against dust and water jets, as noted
- Hazardous Duty® motor Division 2 UL certification nameplate, as noted
- Division 2 / zone 2 class 1 (gases), groups A, B, C, D
- NEMA® JP pump shaft dimensions
- JPV frame (includes drip cover as noted) for vertical mount without base
- JP frame has rigid base, drip cover not included
- Suitable for use on a VFD. 10:1 variable torque and 2:1 constant torque
- 1.15 service factor on sinewave, 1.0 service factor on IGBT power (except as noted)
- Dual rated motors are nameplated 60/50 hertz, 190/380 volts at next lower HP
- Class F Insulation
- Ball bearings, mechanically locked on shaft end
- Standard assembly F1, reversible to F2 assembly (except as noted)
- UL recognized, CSA certified and CE mark



HP	RPM	VOLTS	FRAME	IP55	DIV II	CAT. NO.	MODEL NO.	STOCK	LIST PRICE	MULT. SYMB.	NOM. EFF.	FL. AMPS	WT.	"C" DIM.	FOOT NOTES	
1	3600	208-230/460	143JP	N	N	CPE13	Century®	✓	\$922	S2	77.0	3.2-2.9/1.4	62	18.70		
	1800	200	143JP	N	N	GT3301	143TTFR16049	✓	\$854	S2	85.5	3.8	47	19.13	13	
	1800	200	143JPV	N	N	GT5301	143TTFR16050	✓	\$843	S2	85.5	3.8	46	19.85	13	
	1800	230/460	143JP	N	N	GT3401	143TTFR16051	✓	\$854	S2	85.5	3.3/1.65	47	19.13	13	
	1800	208-230/460	143JP	N	N	CPE11	Century	✓	\$854	S2	85.5	3.1-2.8/1.4	62	18.70		
	1800	230/460	143JPV	N	N	GT5401	143TTFR16043	✓	\$843	S2	85.5	3.3/1.65	46	19.85	13	
	1800	575	143JP	N	N	GT3501	143TTFR16044	✓	\$854	S2	85.5	1.3	47	19.13	13	
	1800	575	143JPV	N	N	GT5501	143TTFR16045	✓	\$843	S2	85.5	1.3	46	19.85	13	
	1200	230/460	145JP	N	N	GT3402	145TTFR16084	✓	\$1,313	S2	82.5	3.8/1.9	60	19.13	13	
	1200	575	145JP	N	N	GT3502	145TTFR16086	✓	\$1,313	S2	82.5	1.5	60	19.13	13	
	1 1/2	3600	200	143JP	N	N	GT3303	143TTFR16009	✓	\$1,004	S2	84.0	4.6	44	18.63	13
		3600	200	143JPV	N	N	GT5303	143TTFR16008	✓	\$991	S2	84.0	4.6	43	19.35	13
3600		230/460	143JP	N	N	GT3403	143TTFR16011	✓	\$1,004	S2	84.0	4.0/2.0	53	18.63	13	
3600		208-230/460	143JP	N	N	CPE17	Century	✓	\$1,004	S2	84.0	4.4-4/2	67	18.70		
3600		230/460	143JPV	N	N	GT5403	143TTFR16012	✓	\$991	S2	84.0	4.0/2.0	65	19.35	13	
3600		575	143JP	N	N	GT3503	143TTFR16015	✓	\$1,004	S2	84.0	1.6	44	18.63	13	
3600		575	143JPV	N	N	GT5503	143TTFR16014	✓	\$991	S2	84.0	1.6	43	19.35	13	
1800		200	145JP	N	N	GT3304	145TTFR16060	✓	\$936	S2	86.5	5.3	49	19.63	13	
1800		200	145JPV	N	N	GT5304	145TTFR16061	✓	\$924	S2	86.5	5.3	49	20.35	13	
1800		230/460	145JP	N	N	GT3404	145TTFR16326	✓	\$936	S2	86.5	4.6/2.3	49	19.63	13	
1800		208-230/460	145JP	N	N	CPE15	Century	✓	\$936	S2	86.5	4.5-4/2	69	19.70		
1800		230/460	145JPV	N	N	GT5404	145TTFR16075	✓	\$924	S2	86.5	4.6/2.3	48	20.35	13	
1800		575	145JP	N	N	GT3504	145TTFR16064	✓	\$936	S2	86.5	1.9	49	19.63	13	
1800		575	145JPV	N	N	GT5504	145TTFR16065	✓	\$924	S2	86.5	1.9	49	20.35	13	
1200		230/460	182JP	N	N	GT3405	182TTFB6085	✓	\$1,439	S2	87.5	4.6/2.3	104	19.07		
1200		575	182JP	N	N	GT3505	182TTFB6095	✓	\$1,439	S2	87.5	1.9	103	19.07		
2		3600	200	145JP	N	N	GT3306	145TTFR16016	✓	\$1,087	S2	85.5	5.8	53	19.63	13
		3600	200	145JPV	N	N	GT5306	145TTFR16011	✓	\$1,074	S2	85.5	5.8	52	20.35	13
	3600	230/460	145JP	N	N	GT3406	145TTFR16014	✓	\$1,087	S2	85.5	5.2/2.6	53	19.63	13	
	3600	208-230/460	145JP	N	N	CPE21	Century	✓	\$1,087	S2	85.5	5.6-5.1/2.5	67	19.70		
	3600	230/460	145JPV	N	N	GT5406	145TTFR16015	✓	\$1,074	S2	85.5	5.2/2.6	52	20.35	13	
	3600	575	145JP	N	N	GT3506	145TTFR16021	✓	\$1,087	S2	85.5	2.0	53	19.63	13	
	3600	575	145JPV	N	N	GT5506	145TTFR16019	✓	\$1,074	S2	85.5	2.0	61	20.35	13	

Catalog numbers (Cat No.) highlighted in bold blue are premium efficient. Blue shaded areas are cast iron frames.

Continued on next page..

CLOSE-COUPLED PUMP, JP, THREE PHASE MOTORS

TEFC, C-FACE FOOTLESS (VERTICAL) AND C-FACE FOOTED (RIGID BASE) MOTORS

HP	RPM	VOLTS	FRAME	IP55	DIV II	CAT. NO.	MODEL NO.	STOCK	LIST PRICE	MULT. SYMB.	NOM. EFF.	FL. AMPS	WT.	"C" DIM.	FOOT NOTES	
2	1800	200	145JP	N	N	GT3307	145TFFR16068	√	\$979	S2	86.5	6.9	50	20.13	13	
	1800	200	145JPV	N	N	GT5307	145TFFR16069	√	\$966	S2	86.5	6.9	52	20.85	13	
	1800	230/460	145JP	N	N	GT3407	145TFFR16056	√	\$979	S2	86.5	6.0/3.0	54	20.13	13	
	1800	208-230/460	145JP	N	N	CPE19	Century®	√	\$979	S2	86.5	5.8-5.2/2.6	67	19.70		
	1800	230/460	145JPV	N	N	GT5407	145TFFR16055	√	\$966	S2	86.5	6.0/3.0	52	20.85	13	
	1800	575	145JP	N	N	GT3507	145TFFR16072	√	\$979	S2	86.5	2.4	53	20.13	13	
	1800	575	145JPV	N	N	GT5507	145TFFR16073	√	\$966	S2	86.5	2.4	52	20.85	13	
	1200	230/460	184JP	N	N	GT3408	184TTFB6085	√	\$1,505	S2	88.5	6.0/3.0	112	20.05		
	1200	575	184JP	N	N	GT3508	184TTFB6095	√	\$1,505	S2	88.5	2.4	122	20.05		
3	3600	230/460	182JP	N	N	GT3409	182TTFB6012	√	\$1,246	S2	86.5	8.0/4.0	90	19.07		
	3600	208-230/460	182JP	N	N	CPE25	Century	√	\$1,246	S2	86.5	8.4-7.6/3.8	98	18.95		
	3600	575	182JP	N	N	GT3509	182TTFB6013	√	\$1,246	S2	86.5	3.2	85	19.07		
	1800	230/460	182JP	N	N	GT3410	182TTFB6037	√	\$1,140	S2	89.5	7.8/3.9	115	19.07		
	1800	208-230/460	182JP	N	N	CPE23	Century	√	\$1,140	S2	89.5	8.8-7.9/4.0	98	18.95		
	1800	575	182JP	N	N	GT3510	182TTFB6038	√	\$1,140	S2	89.5	3.1	118	19.07		
	1200	230/460	213JP	N	N	GT3411	213TTFB6085	√	\$1,753	S2	89.5	8.6/4.3	172	24.54		
	1200	230/460	213JP	N	Y	GT3411A	213TTFBD6085	√	\$1,753	S2	89.5	8.6/4.3	149	24.45		
	1200	575	213JP	N	N	GT3511	213TTFB6095	√	\$1,753	S2	89.5	3.5	165	24.54		
	1200	575	213JP	N	Y	GT3511A	213TTFBD6095	√	\$1,753	S2	89.5	3.5	149	24.54		
	5	3600	230/460	184JP	N	N	GT3412	184TTFB6012	√	\$1,479	S2	88.5	12.0/6.0	100	20.05	
		3600	208-230/460	184JP	N	N	CPE29	Century	√	\$1,479	S2	88.5	14.0-12.0/6.2	105	19.94	
3600		575	184JP	N	N	GT3512	184TTFB6013	√	\$1,479	S2	88.5	4.8	115	20.05		
1800		230/460	184JP	N	N	GT3413	184TTFB6037	√	\$1,377	S2	89.5	12.4/6.2	97	20.05		
1800		208-230/460	184JP	N	N	CPE27	Century	√	\$1,377	S2	89.5	14.0-13.0/6.5	105	19.94		
1800		575	184JP	N	N	GT3513	184TTFB6038	√	\$1,377	S2	89.5	5.0	200	20.05		
1200		230/460	215JP	N	N	GT3414	215TTFB6085	√	\$2,118	S2	89.5	14.0/7.0	166	26.03		
1200		230/460	215JP	N	Y	GT3414A	215TTFBD6085	√	\$2,118	S2	89.5	13.6/6.8	163	26.03		
1200		575	215JP	N	N	GT3514	215TTFB6095	√	\$2,118	S2	89.5	5.6	165	26.03		
1200		575	215JP	N	Y	GT3514A	215TTFBD6095	√	\$2,118	S2	89.5	5.5	168	26.03		
7 1/2		3600	200	213JP	N	N	U328A	—		\$1,846	S2	89.5	21.2	96	25.96	
		3600	230/460	213JP	N	N	GT3415	213TTFB6012	√	\$1,846	S2	91.0	17.4/8.7	169	24.54	
	3600	230/460	213JP	N	Y	GT3415A	213TTFBD6012	√	\$1,846	S2	90.3	18.4/9.2	180	24.54		
	3600	208-230/460	213JP	N	N	CPE33	Century	√	\$1,846	S2	89.5	21.0-19.0/9.3	170	23.67		
	3600	575	213JP	N	N	GT3515	213TTFB6013	√	\$1,846	S2	91.0	7.0	153	24.54		
	3600	575	213JP	N	Y	GT3515A	213TTFBD6013	√	\$1,846	S2	90.3	7.4	165	24.54		
	1800	230/460	213JP	N	N	GT3416	213TTFB6037	√	\$2,110	S2	91.7	19.2/9.6	188	24.54		
	1800	230/460	213JP	N	Y	GT3416A	213TTFBD6037	√	\$2,110	S2	93.3	19.0/9.5	167	24.54		
	1800	208-230/460	213JP	N	N	CPE31	Century	√	\$2,110	S2	89.5	22.0-20.0/9.8	175	23.67		
	1800	575	213JP	N	N	GT3516	213TTFB6038	√	\$2,110	S2	91.7	7.7	170	24.54		
	1800	575	213JP	N	Y	GT3516A	213TTFBD6038	√	\$2,110	S2	93.3	7.6	167	24.54		
	1200	230/460	254JP	N	N	GT3417	254TTFCA6085	√	\$3,662	S2	91.0	21.0/10.5	333	29.51	d	
	1200	230/460	254JP	Y	Y	GT3417A	254TTFCD6085	√	\$3,662	S2	91.0	19.8/9.9	333	29.51		
	1200	575	254JP	N	N	GT3517	254TTFCA6095	√	\$3,662	S2	91.0	8.4	337	29.51	d	
	1200	575	254JP	Y	Y	GT3517A	254TTFCD6095	√	\$3,662	S2	91.0	7.9	337	29.51		
10	3600	230/460	215JP	N	N	GT3418	215TTFB6012	√	\$2,257	S2	90.2	23.0/11.5	210	26.03		
	3600	230/460	215JP	N	Y	GT3418A	215TTFBD6012	√	\$2,257	S2	90.2	23.6/11.8	167	26.03		
	3600	208-230/460	215JP	N	N	CPE38	Century	√	\$2,257	S2	90.2	26.0-24.0/12.0	175	25.24		
	3600	575	215JP	N	N	GT3518	215TTFB6013	√	\$2,257	S2	90.2	9.2	170	26.03		
	3600	575	215JP	N	Y	GT3518A	215TTFBD6013	√	\$2,257	S2	90.2	9.5	170	26.03		
	1800	230/460	215JP	N	N	GT3419	215TTFB6037	√	\$2,525	S2	91.7	25.6/12.8	184	26.03		
	1800	230/460	215JP	N	Y	GT3419A	215TTFBD6037	√	\$2,525	S2	91.7	25.0/12.5	167	26.03		
	1800	208-230/460	215JP	N	N	CPE36	Century	√	\$2,525	S2	91.7	28.0-25.0/13.0	200	25.24		
	1800	575	215JP	N	N	GT3519	215TTFB6038	√	\$2,525	S2	91.7	10.3	183	26.03		
	1800	575	215JP	N	Y	GT3519A	215TTFBD6038	√	\$2,525	S2	91.7	10.0	180	26.03		
	1200	230/460	256JP	N	N	GT3420	256TTFCA6085	√	\$4,474	S2	91.0	28.0/14.0	365	30.71	d	
	1200	230/460	256JP	Y	Y	GT3420A	256TTFCD6085	√	\$4,474	S2	91.0	25.8/12.9	365	30.71		
	1200	575	256JP	N	N	GT3520	256TTFCA6095	√	\$4,474	S2	91.0	11.2	371	30.71	d	
	1200	575	256JP	Y	Y	GT3520A	256TTFCD6095	√	\$4,474	S2	91.0	10.3	371	30.71		

Catalog numbers (Cat No.) highlighted in bold blue are premium efficient.
Blue shaded areas are cast iron frames.

Continued on next page..

CLOSE-COUPLED PUMP, JP, THREE PHASE MOTORS

TEFC, C-FACE FOOTLESS (VERTICAL) AND C-FACE FOOTED (RIGID BASE) MOTORS

HP	RPM	VOLTS	FRAME	IP55	DIV II	CAT. NO.	MODEL NO.	STOCK	LIST PRICE	MULT. SYMB.	NOM. EFF.	FL. AMPS	WT.	"C" DIM.	FOOT NOTES	
15	3600	200	254JP	N	N	U343A	254TTFL16009		\$2,781	S2	91.0	41.5	256	28.21	AL	
	3600	230/460	254JP	N	N	U345B	254TTFL16010	✓	\$2,781	S2	91.0	36.0/18.0	256	28.21	AL	
	3600	230/460	254JP	N	N	GT3421	254TTFCA6012	✓	\$2,821	S2	91.0	35.0/17.5	350	29.51	d	
	3600	230/460	254JP	Y	Y	GT3421A	254TTFCD6012	✓	\$2,821	S2	91.0	35.5/17.8	350	29.51		
	3600	575	254JP	N	N	U356A	—		\$2,781	S2	91.0	14.0	179	27.60	AL	
	3600	575	254JP	N	N	GT3521	254TTFCA6013	✓	\$2,821	S2	91.0	14.0	349	29.51	d	
	3600	575	254JP	Y	Y	GT3521A	254TTFCD6013	✓	\$2,821	S2	91.0	14.3	349	29.51		
	1800	230/460	254JP	N	N	GT3422	254TTFCA6037	✓	\$3,422	S2	92.4	37.0/18.5	350	29.51	d	
	1800	230/460	254JP	Y	Y	GT3422A	254TTFCD6037	✓	\$3,422	S2	92.4	37.5/18.8	350	29.51		
	1800	575	254JP	N	N	GT3522	254TTFCA6038	✓	\$3,422	S2	92.4	15.0	400	29.51	d	
	1800	575	254JP	Y	Y	GT3522A	254TTFCD6038	✓	\$3,422	S2	92.4	15.1	400	29.51		
	1200	230/460	284JP	N	N	GT3423	284TTFCA6085	✓	\$5,938	S2	91.7	39.5/19.8	509	33.82	d	
	1200	230/460	284JP	Y	Y	GT3423A	284TTFCD6085	✓	\$5,938	S2	91.7	40.0/20.0	509	33.82		
	1200	575	284JP	N	N	GT3523	284TTFCA6095	✓	\$5,938	S2	91.7	16.4	504	33.82	d	
	1200	575	284JP	Y	Y	GT3523A	284TTFCD6095	✓	\$5,938	S2	91.7	16.0	504	33.82		
20	3600	230/460	256JP	N	N	GT3424	256TTFCA6012	✓	\$3,326	S2	91.0	46.0/23.0	350	30.71	d	
	3600	230/460	256JP	Y	Y	GT3424A	256TTFCD6012	✓	\$3,326	S2	91.0	47.5/23.7	350	30.71		
	3600	575	256JP	N	N	GT3524	256TTFCA6013	✓	\$3,326	S2	91.0	18.4	415	30.71	d	
	3600	575	256JP	Y	Y	GT3524A	256TTFCD6013	✓	\$3,326	S2	91.0	19.0	415	30.71		
	1800	230/460	256JP	N	N	GT3425	256TTFCA6037	✓	\$3,884	S2	93.0	48.5/24.2	450	30.71	d	
	1800	230/460	256JP	Y	Y	GT3425A	256TTFCD6037	✓	\$3,884	S2	93.0	48.5/24.2	450	31.71		
	1800	575	256JP	N	N	GT3525	256TTFCA6038	✓	\$3,884	S2	93.0	19.4	450	30.71	d	
	1800	575	256JP	Y	Y	GT3525A	256TTFCD6038	✓	\$3,884	S2	93.0	19.4	450	30.71		
	1200	230/460	286JP	N	N	GT3426	286TTFCA6085	✓	\$7,236	S2	91.7	52.0/26.0	534	35.00	d	
	1200	230/460	286JP	Y	Y	GT3426A	286TTFCD6085	✓	\$7,236	S2	91.7	52.0/26.0	534	35.00		
	1200	575	286JP	N	N	GT3526	286TTFCA6095	✓	\$7,236	S2	91.7	21.0	531	35.00	d	
	1200	575	286JP	Y	Y	GT3526A	286TTFCD6095	✓	\$7,236	S2	91.7	20.8	531	35.00		
	25	3600	230/460	284JP	N	N	GT3427	284TTFCA6012	✓	\$3,798	S2	91.7	56.0/28.0	550	33.82	d
		3600	230/460	284JP	Y	Y	GT3427A	284TTFCD6012	✓	\$3,798	S2	91.7	60.0/30.0	550	33.82	
		3600	575	284JP	N	N	GT3527	284TTFCA6013	✓	\$3,798	S2	91.7	22.4	485	33.82	d
3600		575	284JP	Y	Y	GT3527A	284TTFCD6013	✓	\$3,798	S2	91.7	24.0	485	33.82		
1800		230/460	284JP	N	N	GT3428	284TTFCA6037	✓	\$4,153	S2	93.6	61.0/30.5	550	33.82	d	
1800		230/460	284JP	Y	Y	GT3428A	284TTFCD6037	✓	\$4,153	S2	93.6	61.0/30.5	550	33.82		
1800		575	284JP	N	N	GT3528	284TTFCA6038	✓	\$4,153	S2	93.6	24.5	551	33.82	d	
1800		575	284JP	Y	Y	GT3528A	284TTFCD6038	✓	\$4,153	S2	93.6	24.3	551	33.82		
1200		230/460	324JP	N	N	GT3429	324TTFCA6085	✓	\$8,770	S2	93.0	67.0/33.5	651	35.81	d	
1200		230/460	324JP	Y	Y	GT3429A	324TTFCD6085	✓	\$8,770	S2	93.0	67.0/33.5	651	35.81		
1200		575	324JP	N	N	GT3529	324TTFCA6095	✓	\$8,770	S2	93.0	26.8	655	35.81	d	
1200		575	324JP	Y	Y	GT3529A	324TTFCD6095	✓	\$8,770	S2	93.0	26.8	655	35.81		
30		3600	230/460	286JP	N	N	GT3430	286TTFCA6012	✓	\$3,972	S2	91.7	69.0/34.0	550	35.00	d
		3600	230/460	286JP	Y	Y	GT3430A	286TTFCD6012	✓	\$3,972	S2	91.7	71.0/35.5	550	35.00	
		3600	575	286JP	N	N	GT3530	286TTFCA6013	✓	\$3,972	S2	91.7	27.2	560	35.00	d
	3600	575	286JP	Y	Y	GT3530A	286TTFCD6013	✓	\$3,972	S2	91.7	28.5	560	35.00		
	1800	230/460	286JP	N	N	GT3431	286TTFCA6037	✓	\$4,488	S2	93.6	73.0/36.5	600	35.00	d	
	1800	230/460	286JP	Y	Y	GT3431A	286TTFCD6037	✓	\$4,488	S2	93.6	72.5/36.5	600	35.00		
	1800	575	286JP	N	N	GT3531	286TTFCA6038	✓	\$4,488	S2	93.6	29.2	491	35.00	d	
	1800	575	286JP	Y	Y	GT3531A	286TTFCD6038	✓	\$4,488	S2	93.6	29.1	491	35.00		
	1200	230/460	326JP	N	N	GT3432	326TTFCA6085	✓	\$10,100	S2	93.0	81.0/40.5	694	36.99	d	
	1200	230/460	326JP	Y	Y	GT3432A	326TTFCD6085	✓	\$10,100	S2	93.0	81.0/40.5	694	36.99		
	1200	575	326JP	N	N	GT3532	326TTFCA6095	✓	\$10,100	S2	93.0	32.0	690	36.99	d	
	1200	575	326JP	Y	Y	GT3532A	326TTFCD6095	✓	\$10,100	S2	93.0	32.0	690	36.99		
	40	3600	230/460	324JP	N	N	GT3433	324TTFCA6012	✓	\$4,976	S2	92.4	90.0/45.0	650	35.81	d
		3600	230/460	324JP	Y	Y	GT3433A	324TTFCD6012	✓	\$4,976	S2	92.4	90.0/45.0	650	35.81	
		3600	575	324JP	N	N	GT3533	324TTFCA6013	✓	\$4,976	S2	92.4	36.0	650	35.81	d
3600		575	324JP	Y	Y	GT3533A	324TTFCD6013	✓	\$4,976	S2	92.4	36.0	650	35.81		
1800		230/460	324JP	N	N	GT3434	324TTFCA6037	✓	\$5,865	S2	94.1	94.0/47.0	750	35.81	d	
1800		230/460	324JP	Y	Y	GT3434A	324TTFCD6037	✓	\$5,865	S2	94.1	94.0/47.0	750	35.81		
1800		575	324JP	N	N	GT3534	324TTFCA6038	✓	\$5,865	S2	94.1	37.5	740	35.81	d	
1800		575	324JP	Y	Y	GT3534A	324TTFCD6038	✓	\$5,865	S2	94.1	37.5	740	35.81		
50		3600	230/460	326JP	N	N	GT3436	326TTFCA6012	✓	\$6,364	S2	93.0	112.0/56.0	710	36.99	d
	3600	230/460	326JP	Y	Y	GT3436A	326TTFCD6012	✓	\$6,364	S2	93.0	112.0/56.0	710	36.99		
	3600	575	326JP	N	N	GT3536	326TTFCA6013	✓	\$6,364	S2	93.0	44.5	695	36.99	d	
	3600	575	326JP	Y	Y	GT3536A	326TTFCD6013	✓	\$6,364	S2	93.0	44.5	695	36.99		
	1800	230/460	326JP	N	N	GT3437	326TTFCA6037	✓	\$6,781	S2	94.5	119/59.5	736	36.99	d	
	1800	230/460	326JP	Y	Y	GT3437A	326TTFCD6037	✓	\$6,781	S2	94.5	119/59.5	736	36.99		
	1800	575	326JP	N	N	GT3537	326TTFCA6038	✓	\$6,781	S2	94.5	47.5	750	36.99	d	
	1800	575	326JP	Y	Y	GT3537A	326TTFCD6038	✓	\$6,781	S2	94.5	47.5	750	36.99		

Catalog numbers (Cat No.) highlighted in bold blue are premium efficient.

Blue shaded areas are cast iron frames.

Prices and specifications are subject to change without notice.

FIRE PUMP, THREE PHASE MOTORS

ODP, RIGID BASE, EPACT MOTORS

APPLICATIONS:

For use on pumps designed for fire pump duty and installed per NFPA-20. These dripproof motors are intended for installation in relatively clean and dry environments.

Fire Pump motors are not recommended for use with variable frequency drives.



FEATURES:

- UL file EX5190, CSA file LR2025 and CE mark
- 50° C ambient
- Ball bearings
- 1.15 service factor (except as noted)
- Red paint on 25 HP through 250 HP
- NEMA® design B, code G or less
- Dual voltage motors have 12 leads, suitable for wye-delta or across the line start on either voltage, or part winding start on low voltage
- Single voltage motors have 12 leads and are suitable for wye-delta, across the line, or part winding start
- Will accept C-Face kits (except as noted), see accessories section for kits
- 230/460 and 460 Volt models rated for 50 HZ at next lower HP, 1.15 SF, as noted

HP	RPM	VOLTS	FRAME	CAT. NO.	MODEL NO.	STOCK	LIST PRICE	MULT. SYMB.	NOM. EFF.	FL. AMPS	WT.	"C" DIM.	FOOT NOTES
25	3600	200/400	256T	U501	256TTDX4020		\$2,789	E8	91.0	66.5/33.5	126	22.32	
	3600	190/380-400	256T	U501A	256TTDBD4020	✓	\$2,789	E8	91.0	70.0/35.0-33.5	284	24.22	
	3600	230/460	256T	U500	256TTDX4024	✓	\$2,789	E8	91.0	58.0/29.0	164	22.32	d, 68
	3600	230/460	256T	U500A	256TTDBD4024	✓	\$2,789	E8	91.0	58.0/29.0	274	24.22	68
	3600	575	256T	U1100	256TTDBD4008	✓	\$2,789	E8	91.0	23.2	274	24.22	
	1800	200/400	284T	U503	284TTDP4047		\$2,762	E8	91.7	70.0/35.0	412	23.49	
	1800	190/380-400	284T	U599	284TTDBD4047	✓	\$2,762	E8	91.7	74.0/36.5-34.5	378	25.71	
	1800	230/460	284T	U502	284TTDP4027		\$2,762	E8	91.7	61.0/30.5	423	23.49	68
	1800	230/460	284T	U598	284TTDBD4027	✓	\$2,762	E8	91.7	61.0/30.5	378	25.71	68
1800	575	284T	U1101	284TTDBD4035	✓	\$2,762	E8	91.7	24.4	378	25.71		
30	3600	230/460	284TS	U504	284TSTDP4002	✓	\$3,328	E8	91.0	72.0/36.0	432	22.06	d, 68
	3600	230/460	284TS	U597	284TSTDBD4002	✓	\$3,328	E8	91.0	72.0/36.0	399	24.34	68
	3600	200/400	284TS	U505	284TSTDP14007		\$3,328	E8	91.0	83.0/41.5	324	22.06	68
	3600	190/380-400	284TS	U596	284TSTDBD4007	✓	\$3,328	E8	91.0	87.0/43.5-41	374	24.34	
	3600	575	284TS	U1103	284TSTDBD4008	✓	\$3,328	E8	91.0	28.8	374	24.34	
	1800	200/400	286T	U507	286TTDP14042		\$3,213	E8	92.4	83.0/41.5	296	24.99	
	1800	190/380-400	286T	U595	286TTDBD14042	✓	\$3,213	E8	92.4	87.0/43.0-41.0	426	27.09	
	1800	230/460	286T	U506	286TTDP4041		\$3,213	E8	92.4	72.0/36.0	331	24.99	68
	1800	230/460	286T	U594	286TTDBD4041	✓	\$3,213	E8	92.4	72.0/36.0	424	27.09	68
1800	575	286T	U1104	286TTDBD4035	✓	\$3,213	E8	92.4	28.8	424	27.09		
40	3600	200/400	286TS	U509	286TSTDP4023	✓	\$4,259	E8	91.7	108/54.0	327	23.56	d
	3600	190/380-400	286TS	U593	286TSTDBD4023	✓	\$4,259	E8	91.7	114/57.0-54.0	419	25.72	
	3600	230/460	286TS	U508	286TSTDP4022	✓	\$4,259	E8	91.7	94.0/47.0	360	23.56	d, 68
	3600	230/460	286TS	U592	286TSTDBD4022	✓	\$4,259	E8	91.7	94.0/47.0	421	25.72	68
	3600	575	286TS	U1106	286TSTDBD4008	✓	\$4,259	E8	91.7	37.5	421	25.72	
	1800	200/400	324T	U511	324TTDP14049	✓	\$3,996	E8	93.0	155/77.5	431	26.00	d
	1800	190/380-400	324T	U511A	324TTDCCD14049	✓	\$3,996	E8	93.0	114/56.5-53.5	272	28.55	
	1800	230/460	324T	U510	324TTDP4038	✓	\$3,996	E8	93.0	97.0/48.5	465	26.00	d, 68
	1800	230/460	324T	U510A	324TTDCCD4038	✓	\$3,996	E8	93.0	94.0/47.0	272	28.55	68
1800	575	324T	U1107	324TTDCCD4035	✓	\$3,996	E8	93.0	37.5	272	28.55		
50	3600	200/400	324TS	U513	324TSTDP4007	✓	\$5,062	E8	92.4	135/67.5	401	24.50	d
	3600	190/380-400	324TS	U513A	324TSTDCCD4007	✓	\$5,062	E8	92.4	138/69.0-67.0	633	27.05	
	3600	230/460	324TS	U512	324TSTDP4010	✓	\$5,062	E8	92.4	117/58.5	414	24.50	d, 68
	3600	230/460	324TS	U512A	324TSTDCCD4010	✓	\$5,062	E8	92.4	114/57.0	252	27.05	68
	3600	575	324TS	U1109	324TSTDCCD4008	✓	\$5,062	E8	92.4	45.5	252	27.05	
	1800	200/400	326T	U515	326TTDP4344		\$4,657	E8	93.0	141/70.5	498	27.50	
	1800	190/380-400	326T	U515A	326TTDCCD4344	✓	\$4,657	E8	93.0	145/72.0-68.5	324	29.73	
	1800	230/460	326T	U514	326TTDP4345		\$4,657	E8	93.0	123/61.5	515	27.50	68
	1800	230/460	326T	U514A	326TTDCCD4345	✓	\$4,657	E8	93.0	120/60.0	324	29.73	68
1800	575	326T	U1110	326TTDCCD4035	✓	\$4,657	E8	93.0	48.0	324	29.73		

Catalog numbers (Cat No.) highlighted in bold blue are EPAct efficient.

Blue shaded areas are cast iron frames.

Continued on next page.

NEMA is a trademark of National Electrical Manufacturers Association. All Rights Reserved.

Prices and specifications are subject to change without notice.

marathon
Motors

FIRE PUMP, THREE PHASE MOTORS

ODP, RIGID BASE, EPACT MOTORS

HP	RPM	VOLTS	FRAME	CAT. NO.	MODEL NO.	STOCK	LIST PRICE	MULT. SYMB.	NOM. EFF.	FL. AMPS	WT.	"C" DIM.	FOOT NOTES
60	3600	200/400	326TS	U517	326TSTDP4022	√	\$5,755	E8	93.0	155/77.5	480	26.00	d
	3600	190/380-400	326TS	U517A	326TSTDCD4022	√	\$5,755	E8	93.0	165/82.5-77.5	694	28.23	
	3600	230/460	326TS	U516	326TSTDP4024	√	\$5,755	E8	93.0	135/67.5	378	26.00	d, 68
	3600	230/460	326TS	U516A	326TSTDCD4024	√	\$5,755	E8	93.0	136/68.0	277	28.23	68
	3600	575	326TS	U1112	326TSTDCD4008	√	\$5,755	E8	93.0	54.5	277	28.23	
	1800	200/400	326TS	U521	326TSTDR14034		\$5,235	E8	93.6	167/83.5	418	29.50	
1800	200/400	364TS		U519	364TSTDS4337		\$5,868	E8	93.6	166/83.0	663	26.50	
	190/380-400	364TS		U519A	364TSTDCD4337	√	\$5,868	E8	93.6	167/83.5-80.0	839	29.57	
	200/400	364T		U538	364TTDS14329		\$5,868	E8	93.6	166/83.0	686	28.62	
	230/460	364T		U520	364TTDS4328		\$5,868	E8	93.6	144/72.0	716	28.62	68
	230/460	364TS		U518	364TSTDS4332	√	\$5,868	E8	93.6	144/72.0	699	26.50	d, 68
	230/460	364TS		U518A	364TSTDCD4332	√	\$5,868	E8	93.6	138/69.0	846	29.57	68
	575	364TS		U1113	364TSTDCD4035	√	\$5,868	E8	93.6	55.0	846	29.57	
	200/400	364TS		U523	364TSTDS4024	√	\$7,887	E8	93.0	210/105	713	26.50	d
	190/380-400	364TS		U523A	364TSTDCD4024	√	\$7,887	E8	93.0	206/103-99.0	826	29.57	
	230/460	364TS		U522	364TSTDS4025	√	\$7,887	E8	93.0	183/91.5	750	26.50	d, 68
3600	230/460	364TS		U522A	364TSTDCD4025	√	\$7,887	E8	93.0	170/85.0	807	29.57	68
	575	364TS		U1115	364TSTDCD4008	√	\$7,887	E8	93.0	68.0	807	29.57	
	200/400	365TS		U525	365TSTDS4347		\$7,148	E8	94.1	204/102	766	27.50	
	190/380-400	365TS		U525A	365TSTDCD4347	√	\$7,148	E8	94.1	206/103-97.0	879	31.14	
	230/460	365TS		U524	365TSTDS4332	√	\$7,148	E8	94.1	177/88.5	772	27.50	d, 68
	230/460	365TS		U524A	365TSTDCD4332	√	\$7,148	E8	94.1	170/85.0	416	31.14	68
	575	365TS		U1116	365TSTDCD4035	√	\$7,148	E8	94.1	68.0	416	31.14	
	200/400	365TS		U527	365TSTDS4303	√	\$10,361	E8	93.0	276/138	748	27.50	d
	190/380-400	365TS		U527A	365TSTDCD4303	√	\$10,361	E8	93.0	276/138-132	927	31.14	
	230/460	365TS		U526	365TSTDS4025	√	\$10,361	E8	93.0	240/120	775	27.50	d, 68
3600	230/460	365TS		U526A	365TSTDCD4025	√	\$10,361	E8	93.0	228/114	919	31.14	68
	575	365TS		U1118	365TSTDCD4008	√	\$10,361	E8	93.0	91.0	919	31.14	
	200/400	404TS		U529	404TSTDS4333	√	\$9,255	E8	94.1	271/136	1009	29.50	d
	190/380-400	404TS		U529A	404TSTDCD4333	√	\$9,116	E8	94.1	276/137-130	575	33.86	
	230/460	404TS		U528	404TSTDS4332	√	\$9,116	E8	94.1	236/118	1002	29.50	d, 68
	230/460	404TS		U528A	404TSTDCD4332	√	\$9,116	E8	94.1	228/114	525	33.86	68
	575	404TS		U1119	404TSTDCD4035	√	\$9,116	E8	94.1	91.0	575	33.86	
	200/400	404TS		U531	404TSTDS14008	√	\$12,889	E8	93.6	327/163	949	29.50	d
	380-400	404TS		U531A	404TSTDCD14008	√	\$12,889	E8	93.6	167-159	1159	33.86	
	230/460	404TS		U530	404TSTDS4017	√	\$12,889	E8	93.6	284/142	1005	29.50	68
3600	460	404TS		U530A	404TSTDCD4017	√	\$12,889	E8	93.6	139	1165	33.86	68
	575	404TS		U1121	404TSTDCD4008	√	\$12,889	E8	93.6	111	1165	33.86	
	200/400	405TS		U533	405TSTDS4333		\$10,916	E8	94.5	336/168	1070	31.00	
	380-400	405TS		U533A	405TSTDCD4333	√	\$10,916	E8	94.5	170-162	651	35.44	
	230/460	405TS		U532	405TSTDS4332	√	\$10,916	E8	94.5	288/144	1125	31.00	d, 68
	460	405TS		U532A	405TSTDCD4332	√	\$10,916	E8	94.5	142	605	35.44	68
	575	405TS		U1122	405TSTDCD4035	√	\$10,916	E8	94.5	114	605	35.44	
	200/400	405TS		U534	405TSTDS4006	√	\$15,679	E8	93.6	169	1004	31.00	d, 68
	460	405TS		U534A	405TSTDCD4006	√	\$15,679	E8	93.6	168	1244	35.44	68
	575	405TS		U1124	405TSTDCD4008	√	\$15,679	E8	93.6	134	1244	35.44	
1800	460	444TS		U535	444TSTDS4332	√	\$15,764	E8	95.0	173	1286	34.00	d, 68
	460	444TS		U535A	444TSTDCD4332	√	\$15,764	E8	95.0	170	835	40.83	68
	575	444TS		U1125	444TSTDCD4035	√	\$15,764	E8	95.0	136	835	40.83	
	200/400	444TS		U536	444TSTDS4010	√	\$24,391	E8	94.5	225	1313	34.00	d, 68
3600	460	444TS		U536A	444TSTDCD4010	√	\$24,391	E8	94.5	220	750	40.83	68
	575	444TS		U1127	444TSTDCD4008	√	\$24,391	E8	94.5	176	750	40.83	
	460	445TS		U537	445TSTDS4332	√	\$19,916	E8	95.0	233	1414	36.00	d, 68
	460	445TS		U537A	445TSTDCD4332	√	\$19,916	E8	95.0	225	900	40.83	68
	575	445TS		U1128	445TSTDCD4035	√	\$19,916	E8	95.0	180	1015	40.83	

Catalog numbers (Cat No.) highlighted in bold blue are EPAct efficient.

Blue shaded areas are cast iron frames.

Continued on next page.

PUMP MOTORS

FIRE PUMP, THREE PHASE MOTORS

ODP, RIGID BASE, EPACT MOTORS

HP	RPM	VOLTS	FRAME	CAT. NO.	MODEL NO.	STOCK	LIST PRICE	MULT. SYMB.	NOM. EFF.	F.L. AMPS	WT.	"C" DIM.	FOOT NOTES
250	3600	460	445TS	U539	445TSTDS14007	√	\$25,400	E8	94.5	279	1456	36.00	d, 68
	3600	460	445TS	U539A	445TSTDCD4007	√	\$25,400	E8	94.5	272	1900	40.83	68
	3600	575	445TS	U1130	445TSTDCD4008	√	\$25,400	E8	94.5	218	1510	40.83	
	1800	460	445TS	U540	445TSTDS14051	√	\$21,978	E8	95.4	287	1510	36.00	d, 68
	1800	460	445TS	U540A	445TSTDCD14051	√	\$21,978	E8	95.4	278	1090	40.83	68
	1800	575	447TS	U1131	445TSTDCD4036	√	\$21,978	E8	95.4	222	1500	45.95	
300	3600	460	447TS	H178	447TSTDN7001	√	\$26,963	E8	95.0	332	1940	39.50	25, 68
	1800	460	447TS	H812	447TSTDN7026	√	\$25,462	E8	95.4	345	1994	39.50	25, 68
350	3600	460	447TS	H193	447TSTDN7003	√	\$30,885	E8	95.0	385	2013	39.50	25, 68
	1800	460	447TS	H813	447TSTDN7027	√	\$27,672	E8	95.4	405	2064	39.50	25, 68
400	3600	460	447TS	H817	447TSTDN7005	√	\$35,141	E8	95.4	435	2150	39.50	25, 68
	1800	460	447TS	H814	447TSTDN7028	√	\$32,117	E8	95.4	450	2220	39.50	25, 68
450	3600	460	449TS	H818	449TSTDN7001	√	\$37,533	E8	95.8	502	2544	44.50	25, 68
	1800	460	449TS	H815A	449TSTDN14033	√	\$36,926	E8	95.8	505	2564	44.50	17, 25, 68
500	3600	460	449TS	H819A	449TSTDN14005	√	\$45,567	E8	95.8	545	2620	44.50	25, 68
	1800	460	449TS	H816	449TSTDN7027	√	\$37,611	E8	95.8	560	2695	44.50	17, 25, 68

Catalog numbers (Cat No.) highlighted in bold blue are EPAct efficient.

Blue shaded areas are cast iron frames.

FIRE PUMP, THREE PHASE MOTORS

TEFC, RIGID BASE, EPACT MOTORS

APPLICATIONS:

For use on pumps designed for fire pump duty and installed per NFPA-20.

Fire Pump motors are not recommended for use with variable frequency drives.



FEATURES:

- UL file EX5190, CSA file LR2025 and CE mark
- Ball bearings
- 1.15 service factor
- Red paint exterior
- NEMA® Design B, Code G or less
- Dual voltage motors have 12 leads, suitable for wye-delta or across the line start on either voltage, or part winding start on low voltage
- Single voltage motors have 12 leads and are suitable for wye-delta, across the line, or part winding start
- Will accept C- Face kits, see accessories section
- 230/460 and 460 volt models rated for 50 HZ at next lower HP, 1.15 SF
- For special designs, contact district sales office near you

HP	RPM	VOLTS	FRAME	CAT. NO.	MODEL NO.	STOCK	LIST PRICE	MULT. SYMB.	NOM. EFF.	FL. AMPS	WT.	"C" DIM.	FOOT NOTES
3	3600	230/460	182T	Y1600	—		\$1,436	E8	85.5	7.4/3.7	84	15.87	
	1800	230/460	182T	Y1601	—		\$1,055	E8	87.5	8.6/4.3	90	15.87	
5	3600	230/460	184T	Y1602	—		\$1,653	E8	87.5	12.2/6.1	108	15.87	
	1800	230/460	184T	Y1603	—		\$1,218	E8	87.5	13.0/6.5	123	15.87	
7.5	3600	230/460	213T	Y1604	—		\$2,091	E8	88.5	19.0/9.5	188	18.20	
	1800	230/460	213T	Y1605	—		\$1,554	E8	89.5	20.0/10.0	194	19.63	
10	3600	230/460	215T	Y1606	—		\$2,442	E8	89.5	24.0/12.0	217	19.63	
	1800	230/460	215T	Y1607	—		\$1,890	E8	89.5	25.0/12.5	227	22.63	
15	3600	230/460	254T	Y1608	254TTFPA14014	√	\$3,443	E8	90.2	35.0/17.5	262	23.47	d
	1800	230/460	254T	Y1609	254TTFNA14336	√	\$2,787	E8	91.0	39.0/19.5	297	23.65	d
20	3600	230/460	256T	Y1610	256TTFNA14022	√	\$3,905	E8	90.2	46.5/23.2	325	25.40	d
	1800	230/460	256T	Y1611	256TTFNA14071	√	\$3,302	E8	91.0	50.0/25.0	331	25.27	d
25	3600	230/460	284TS	Y1612	284TSTFPA14007	√	\$4,160	E8	91.0	59.0/29.5	378	24.93	d
	1800	230/460	284T	Y1613	284TTFPA14055	√	\$3,591	E8	92.4	61.0/30.5	369	26.39	d
30	3600	230/460	286TS	Y1614	286TSTFPA14006	√	\$4,325	E8	91.0	70.0/35.0	413	26.43	d
	1800	230/460	286T	Y1615	286TTFNA14050	√	\$4,177	E8	92.4	72.0/36.0	484	27.71	d
40	3600	230/460	324TS	Y1616	324TSTFPA14010	√	\$5,537	E8	91.7	92.0/46.0	531	27.47	d
	1800	230/460	324T	Y1618	324TTFPA14071	√	\$5,194	E8	93.0	100/50.0	583	28.97	d
50	3600	230/460	326TS	Y1619	326TSTFPA14013	√	\$6,581	E8	92.4	112/56.0	522	28.97	d
	1800	230/460	326T	Y1621	326TTFNA14046	√	\$6,055	E8	93.0	122/61.0	681	30.38	d
60	3600	230/460	364TS	Y1622	364TSTFPA14009	√	\$7,481	E8	93.0	138/69.0	815	29.38	d
	1800	230/460	364T	Y1624	364TTFNA14064		\$7,629	E8	93.6	142/71.0	882	31.52	
75	3600	230/460	365TS	Y1625	365TSTFPA14009	√	\$10,254	E8	93.0	172/86.0	911	30.38	d
	1800	230/460	365T	Y1627	365TTFNA14071		\$9,293	E8	94.1	176/88.0	990	32.52	
100	3600	230/460	405TS	Y1628	405TSTFPA14007	√	\$13,469	E8	94.1	224/112	1103	34.13	d
	1800	230/460	405T	Y1630	405TTFNA14328		\$11,851	E8	94.5	224/112	1234	37.13	

Catalog numbers (Cat No.) highlighted in bold blue are EPAct efficient.

Blue shaded areas are cast iron frames.

Continued on next page..

FIRE PUMP, THREE PHASE MOTORS

TEFC, RIGID BASE, EPACT MOTORS

HP	RPM	VOLTS	FRAME	CAT. NO.	MODEL NO.	STOCK	LIST PRICE	MULT. SYMB.	NOM. EFF.	FL. AMPS	WT.	"C" DIM.	FOOT NOTES
125	3600	460	444TS	Y1631	—		\$16,755	E8	94.5	136	1750	37.50	
	1800	460	444T	Y1633	—		\$14,190	E8	94.5	145	1805	43.35	
150	3600	460	445TS	Y1634	445TSTFN14013	√	\$20,382	E8	94.5	165	1981	39.60	d
	1800	460	445TS	Y1635	445TSTFN14067		\$20,492	E8	95.0	170	1860	39.60	
	1800	460	445T	Y1636	445TTFN14337	√	\$20,492	E8	95.0	170	2026	43.35	d
200	3600	460	445TS	Y1637	445TSTFN14014	√	\$31,708	E8	95.0	220	2108	39.60	d
	1800	460	445TS	Y1638	445TSTFN14066		\$25,890	E8	95.0	224	2164	39.60	
	1800	460	445T	Y1639	445TTFN14338		\$25,890	E8	95.0	224	1878	43.35	
250	3600	460	449TS	Y1640	449TSTFS14012		\$33,019	E8	95.4	270	2700	48.11	
	1800	460	449TS	Y1641	449TSTFS14040		\$28,571	E8	95.4	285	2732	48.11	
	1800	460	449T	Y1642	449TTFS14055		\$28,571	E8	95.0	290	2550	51.86	
300	3600	460	449TS	Y1643	—		\$35,052	E8	95.4	330	2850	47.88	
	1800	460	449TS	Y1644	449TSTFS14045		\$33,101	E8	95.4	335	2720	48.11	
	1800	460	449T	Y1645	449TTFS14057		\$33,101	E8	95.4	335	3041	51.86	
350	3600	460	449TS	Y1646	—		\$40,151	E8	95.4	380	3064	47.88	
	1800	460	449TS	Y1647	449TSTFS14044		\$35,974	E8	95.4	400	2720	48.11	
	1800	460	449T	Y1648	449TTFS14056		\$35,974	E8	95.4	400	3202	51.86	
400	3600	460	5011S	Y1649	—		\$73,540	E8	95.4	432	5500	67.19	
	1800	460	5011L	Y1650	—		\$63,948	E8	95.4	448	5800	67.19	
450	3600	460	5011L	Y1651	—		\$75,597	E8	95.4	515	5845	67.19	
	1800	460	5011L	Y1652	—		\$65,737	E8	95.4	495	5942	67.19	

Catalog numbers (Cat No.) highlighted in bold blue are EPAct efficient.

Blue shaded areas are cast iron frames.

VERTICAL SOLID SHAFT P-BASE MOTORS

THREE PHASE, DRIPPROOF MOTORS



APPLICATIONS:

For use on: Vertical end suction, short couple, centrifugal, non-clog, mix flow, turbine, and propeller pumps. HP type shafts, per NEMA® MG-1 18.625. HPH and TCV type shafts, single phase, and other modifications such as adding screens are also available through special order. Contact your sales representative for more information.

FEATURES:

- Meets or exceeds NEMA Premium® efficiencies
- Normal and medium thrust
- Rolled steel frames are normal thrust. Cast iron frames are medium thrust
- Ball bearings and angular contact bearings for medium thrust applications
- Class F insulation
- 1.15 service factor
- Suitable for 230 volt part winding start through 100 HP (dual voltage motors)
- Heavy duty lifting lugs
- Drip cover/canopy cap included
- UL recognized and CSA certified
- UL Listed for Fire Pump applications (except as noted)

HP	RPM	VOLTS	FRAME	CAT. NO.	MODEL NO.	STOCK	LIST PRICE	MULT. SYMB.	NOM. EFF.	F.L. AMPS	WT.	DOWN THRUST	BASE DIA.	"C" DIM.	FOOT NOTES
3	3600	230/460	182HP	M800B	—		\$1,705	S5	85.5	8.4/4.2	47	260	9.88	14.00	98
	1800	230/460	182HP	M801B	—		\$1,793	S5	89.5	9.3/4.7	83	390	9.88	17.18	98
	1200	230/460	213HP	M802B	213TTDWD16089		\$2,336	S5	88.5	9.0/4.5	129	560	9.88	20.30	98
5	3600	230/460	182HP	M803B	—		\$2,397	S5	86.5	13.0/6.5	87	310	9.88	17.68	98
	1800	230/460	184HP	M804B	184TTDWD16338		\$2,303	S5	89.5	12.6/6.3	120	490	9.88	17.18	98
	1200	230/460	215HP	M805B	215TTDWD16091		\$3,297	S5	89.5	13.8/6.9	129	650	9.88	21.55	98
7 1/2	3600	230/460	184HP	M806B	—		\$2,988	S5	88.5	18.0/9.0	84	380	9.88	16.91	98
	1800	230/460	213HP	M807B	213TTDWD16342		\$2,878	S5	91.0	20.0/10.0	123	560	9.88	20.30	98
	1200	230/460	254HP	M808B	254TTDX16086		\$3,925	S5	90.2	21.4/10.7	210	720	9.88	24.30	98
	1200	230/460	254HP	M708	—		\$3,925	S5	90.2	18.0/9.0	115	3000	9.88	16.91	
10	3600	230/460	213HP	M809B	—		\$2,285	S5	89.5	25.0/12.5	114	450	9.88	21.01	98
	1800	230/460	215HP	M810B	215TTDWD16350		\$3,232	S5	91.7	26.2/13.1	123	560	9.88	20.30	98
	1200	230/460	256HP	M811B	—		\$4,442	S5	91.7	27.6/13.8	189	720	9.88	24.30	98
	1200	230/460	256HP	M711	256TTDN16082		\$4,434	S5	91.7	26.0/13.0	238	3000	9.88	24.30	
	900	230/460	284HP	M712	—		\$5,016	S5	90.2	29.0/14.5	325	4125	9.88	27.26	
15	3600	230/460	215HP	M813B	215TTDWD14018		\$3,760	S5	90.2	36.5/18.2	129	520	9.88	21.55	98
	1800	230/460	254HP	M814B	254TTDX16054		\$3,865	S5	93.0	38.5/19.2	227	640	9.88	24.30	98
	1800	230/460	254HP	M714	—		\$3,865	S5	93.0	39.0/19.6	344	2400	9.88	22.35	
	1200	230/460	284HP	M715	284TTDN16087		\$5,167	S5	91.7	41.0/20.4	570	1950	12.55	27.06	
	900	230/460	284HP	M716	—		\$6,386	S5	90.2	42.0/21.0	701	4125	12.55	28.76	
20	3600	230/460	254HP	M817B	—		\$3,930	S5	91.0	47.0/23.5	199	520	9.88	25.07	98
	3600	230/460	254HP	M717	—		\$3,930	S5	91.0	47.0/23.5	186	1950	9.88	28.26	
	1800	230/460	256HP	M818B	256TTDR16029		\$4,408	S5	93.0	49.0/24.5	241	640	9.88	24.30	98
	1800	230/460	256HP	M718A	256TTDN16067		\$5,183	S5	93.0	48.0/24.0	284	2400	9.88	27.87	
	1200	230/460	286HP	M719	286TTDN16093		\$7,392	S5	92.4	52.0/26.0	562	3000	12.55	29.56	
	900	230/460	324HP	M820B	—		\$7,073	S5	90.2	60.0/30.0	465	1100	16.38	28.06	98
	900	230/460	324HP	M720	324TTDN16101		\$7,073	S5	90.2	60.0/30.0	465	4125	16.38	30.56	
25	3600	230/460	256HP	M821B	—		\$4,346	S5	91.7	58.0/29.0	225	520	9.88	24.30	98
	3600	230/460	256HP	M721A	256TTDN16018		\$5,111	S5	91.7	58.0/29.0	357	1950	9.88	27.84	
	1800	230/460	284HP	M722	284TTDN16063		\$5,777	S5	93.6	62.0/31.0	289	2625	12.55	27.06	
	1200	230/460	324HP	M823B	324TTDR16091		\$6,829	S5	93.0	65.0/32.5	588	1000	16.38	30.06	98
	1200	230/460	324HP	M723	324TTDN16077		\$8,030	S5	93.0	65.0/32.5	601	3750	16.38	31.93	
	900	230/460	326HP	M824B	326TTDR16102		\$8,147	S5	90.2	73.0/36.5	498	1100	16.38	30.56	98
	900	230/460	326HP	M724	326TTDN16101		\$9,127	S5	90.2	73.0/36.5	531	4125	16.38	31.93	
30	3600	230/460	284HP	M725	284TTDN16007		\$4,757	S5	91.7	68.0/34.0	292	2063	12.55	27.06	
	1800	230/460	286HP	M726	286TTDN16330		\$6,327	S5	94.1	74.0/37.0	520	2625	12.55	29.56	
	1200	230/460	326HP	M827B	—		\$7,773	S5	93.6	82.0/41.0	478	1000	16.38	33.44	98
	1200	230/460	326HP	M727	—		\$8,580	S5	93.6	76.0/38.0	788	3750	16.38	33.44	
900	230/460	364HP	M728	364TTDS16105		\$9,142	S5	91.0	82.0/41.0	700	4125	16.50	29.00		

Catalog numbers (Cat No.) highlighted in bold blue are premium efficient.

Blue shaded areas are cast iron frames.

Continued on next page.

VERTICAL SOLID SHAFT P-BASE MOTORS

THREE PHASE, DRIPPROOF MOTORS

HP	RPM	VOLTS	FRAME	CAT. NO.	MODEL NO.	STOCK	LIST PRICE	MULT. SYMB.	NOM. EFF.	FL. AMPS	WT.	DOWN THRUST	BASE DIA.	"C" DIM.	FOOT NOTES
40	3600	230/460	286HP	M729	286TTDN16011		\$6,219	S5	92.4	90.0/45.0	602	2063	12.55	28.56	
	1800	230/460	324HP	M830B	324TTDR16056		\$6,112	S5	94.1	97.0/48.5	632	800	16.38	30.06	98
	1800	230/460	324HP	M730	—		\$7,077	S5	94.1	97.0/48.5	480	3000	16.38	28.06	
	1200	230/460	364HP	M731	364TTDS16088		\$9,049	S5	94.1	101/50.5	784	3750	16.50	28.06	
	900	230/460	365HP	M732	365TTDS16101		\$11,019	S5	91.0	105/52.5	784	4125	16.50	29.00	
50	3600	230/460	324HP	M833B	324TTDR16007		\$7,172	S5	93.6	112/56.0	574	600	16.38	29.56	98
	3600	230/460	324HP	M733	—		\$7,420	S5	93.6	117/58.5	510	2250	16.38	28.06	
	1800	230/460	326HP	M734	326TTDN16035		\$8,128	S5	95.0	124/62.0	615	3000	16.38	30.56	
	1200	230/460	365HP	M735	365TTDS16086		\$11,239	S5	94.5	125/62.5	784	3750	16.50	29.00	
	900	460	404HP	M736	404TTDS16102		\$12,560	S5	92.4	65.0	1244	5250	16.50	31.75	
60	3600	230/460	326HP	M837B	326TTDR16005		\$8,023	S5	93.6	135/67.5	498	600	16.38	30.56	98
	3600	230/460	326HP	M737	—		\$8,988	S5	93.6	135/67.5	839	2250	16.38	30.56	
	1800	230/460	364HP	M738	364TTDS16052		\$8,378	S5	95.0	139/69.5	1026	3000	16.50	34.19	
	1200	230/460	404HP	M739	404TTDS16093		\$12,828	S5	95.0	146/73.0	1049	4500	16.50	31.75	
	900	230/460	405HP	M740	405TTDS16102		\$14,484	S5	93.0	160/80.0	1077	5250	16.50	31.75	
75	3600	230/460	364HP	M741	364TTDS16009		\$10,039	S5	94.5	170/85.0	733	2250	16.50	29.00	
	1800	230/460	365HP	M742	365TTDS16072		\$10,200	S5	95.0	174/87.0	810	3000	16.50	29.00	
	1200	230/460	405HP	M743	405TTDS16089		\$15,090	S5	95.0	180/90.0	1097	4500	16.50	31.75	
	900	460	444HP	M744	444TTDN16101		\$16,612	S5	93.6	107	1548	6000	16.38	36.02	
100	3600	230/460	365HP	M745	365TTDS16016		\$13,529	S5	94.1	230/115	784	2250	16.50	29.00	
	1800	230/460	404HP	M746	404TTDS16332		\$12,887	S5	95.4	226/113	1162	3375	16.50	35.64	
	1200	460	444HP	M747	444TTDN16078		\$18,728	S5	94.0	246/123	1548	5250	16.38	36.02	
	900	460	445HP	M748	445TTDN16101		\$22,287	S5	94.1	135	1548	6000	16.38	36.02	
125	3600	460	404HP	M749	404TTDS16010		\$19,990	S5	95.0	138	1009	2250	16.50	31.75	
	1800	460	405HP	M750	405TTDS16070		\$15,565	S5	95.4	141	1142	3375	16.50	31.75	
	1200	460	445HP	M751	445TTDN16080		\$22,239	S5	95.0	152	1548	5250	16.38	36.02	
	900	460	505P	M752	505UTDS16102		\$29,620	S5	94.5	170	1976	6000	20.00	38.75	98
150	3600	460	405HP	M753	405TTDS16010		\$20,652	S5	95.0	165	1082	2250	16.50	31.75	
	1800	460	444HP	M754	444TTDN16027		\$18,674	S5	95.8	172	1548	3375	16.38	36.02	
	1200	460	445HP	M755	445TTDN16079		\$26,858	S5	95.4	178	1548	5250	16.38	36.02	
	900	460	505P	M756	505UTDS16103		\$36,714	S5	94.5	191	2148	6000	20.00	38.75	98
200	3600	460	444HP	M757	444TTDN16003		\$28,225	S5	95.0	220	1548	2250	16.38	36.02	
	1800	460	445HP	M758	445TTDN16031		\$25,379	S5	95.8	226	1548	3375	16.38	36.02	
	1200	460	505P	M759	505UTDS16076		\$39,257	S5	95.4	240	2145	5250	20.00	38.75	98
	900	460	505P	M760	505UTDS16101		\$41,316	S5	94.1	265	1960	6000	20.00	38.75	98
250	3600	460	445HP	M761	445TTDN16002		\$30,216	S5	95.4	275	1446	2250	16.38	36.02	
	1800	460	445HP	M762	445TTDN16032		\$26,824	S5	95.8	282	1548	3750	16.38	36.02	
	1200	460	505P	M763	508UTDS16078		\$41,866	S5	95.8	300	2318	5250	20.00	38.75	98
	900	460	508P	M764	—		\$50,103	S5	95.0	308	1562	6000	20.00	45.75	98
300	3600	460	449T	M765	—		\$38,079	S5	95.4	362	1900	2250	16.38	36.02	
	1800	460	505P	M766	—		\$32,310	S5	95.8	340	1937	3750	20.00	38.75	98
	1200	460	508P	M767	—		\$48,284	S5	95.8	342	2877	5250	20.00	45.75	98
	900	460	508P	M768	—		\$59,256	S5	95.0	375	1988	6000	20.00	45.75	98
350	3600	460	505P	M769	—		\$45,819	S5	95.4	378	2375	2250	20.00	38.75	98
	1800	460	505P	M770	—		\$37,565	S5	95.8	402	2421	3750	20.00	38.75	98
	1200	460	508P	M771	—		\$55,961	S5	95.8	400	3596	5250	20.00	45.75	98
400	1800	460	505P	M773	—		\$45,076	S5	95.8	455	3027	3750	20.00	38.75	98
	1200	460	508P	M774	—		\$64,270	S5	95.8	460	4495	5250	20.00	45.75	98

Catalog numbers (Cat No.) highlighted in bold blue are premium efficient.

Blue shaded areas are cast iron frames.

VERTICAL SOLID SHAFT P-BASE MOTORS

THREE PHASE, TOTALLY ENCLOSED MOTORS

APPLICATIONS:

For use on: Vertical end suction, short couple, centrifugal, non-clog, mix flow, turbine, and propeller pumps. Totally Enclosed, Fan Cooled construction restricts the free exchange of ambient air inside the motor. Suitable for demanding applications in the process industries. HP type shafts, per NEMA® MG-1, 18.625. HPH type shafts, severe duty features, explosion proof, and other modifications such as adding screens are also available through special order. Contact your sales representative for more information.

FEATURES:

- Meets or exceeds NEMA Premium® efficiencies
- Normal thrust
- Class F insulation
- 1.15 service factor
- Suitable for 230 volt part winding start through 100 HP (dual voltage motors)
- Heavy duty lifting lugs
- Drip cover/canopy cap included
- UL recognized and CSA certified

HP	RPM	VOLTS	FRAME	CAT. NO.	MODEL NO.	STOCK	LIST PRICE	MULT. SYMB.	NOM. EFF.	F.L. AMPS	WT.	DOWN THRUST.	BASE DIA.	"C" DIM.
3	3600	230/460	182HP	M875B	182TTFR16017		\$2,305	S5	86.5	7.4/3.7	89	260	9.88	18.05
	1800	230/460	182HP	M876B	—		\$2,021	S5	89.5	8.4/4.2	124	390	9.88	18.05
	1200	230/460	213HP	M877B	213TTFW16085		\$3,152	S5	89.5	8.8/4.4	172	560	9.88	22.66
5	3600	230/460	184HP	M787B	—		\$3,086	S5	88.5	12.0/6.0	115	390	9.88	20.05
	1800	230/460	184HP	M879B	184TTFR16054		\$2,831	S5	90.2	12.4/6.2	160	490	9.88	20.05
	1200	230/460	215HP	M880B	215TTFWD16084		\$4,442	S5	89.5	14.0/7.0	139	650	9.88	23.91
7 1/2	3600	230/460	213HP	M881B	213TTFWD16016		\$4,007	S5	89.5	18.6/9.3	157	380	9.88	22.66
	1800	230/460	213HP	M882B	—		\$3,701	S5	91.7	19.0/9.5	189	490	9.88	22.66
	1200	230/460	254HP	M883B	254TTFNA16088		\$5,298	S5	91.0	19.8/9.9	422	720	9.88	28.26
10	3600	230/460	215HP	M884B	215TTFWD16017		\$4,364	S5	90.2	23.6/11.8	172	450	9.88	22.66
	1800	230/460	215HP	M885B	—		\$4,364	S5	91.7	26.0/13.0	158	560	9.88	23.91
	1200	230/460	256HP	M886B	256TTFNA16099		\$5,981	S5	91.0	26.2/13.1	425	720	9.88	28.26
15	3600	230/460	254HP	M888B	—		\$5,030	S5	91.0	35.0/17.5	272	520	9.88	28.26
	1800	230/460	254HP	M889B	—		\$5,178	S5	92.4	35.6/17.8	389	640	9.88	28.26
	1200	230/460	284HP	M890B	284TTFPA16033		\$6,974	S5	92.4	36.0/18.0	400	800	9.88	28.88
20	3600	230/460	256HP	M892B	256TTFNA16106		\$5,503	S5	91.0	48.0/24.0	413	520	9.88	28.26
	1800	230/460	256HP	M893B	256TTFNA16031		\$5,942	S5	93.0	48.0/24.1	536	640	9.88	28.26
	1200	230/460	286HP	M894B	286TTFNA16096		\$8,476	S5	92.1	53.5/26.7	438	800	9.88	30.84
25	3600	230/460	284HP	M896B	284TTFNA16015		\$5,814	S5	93.6	56.0/28.1	542	550	9.88	30.84
	1800	230/460	284HP	M897B	284TTFNA16131		\$6,622	S5	93.6	62.0/31.0	466	700	9.88	28.88
	1200	230/460	324HP	M898B	324TTFS16087		\$9,918	S5	93.0	65.0/32.5	778	1000	16.38	35.62
	900	230/460	326HP	M899B	326TTFS16106		\$11,406	S5	90.2	73.0/36.5	778	1100	16.38	35.62
30	3600	230/460	286HP	M900B	286TTFNA16021		\$6,415	S5	93.0	67.0/33.5	535	550	9.88	27.38
	1800	230/460	286HP	M901B	286TTFNA16341		\$8,305	S5	94.1	73.0/36.5	570	700	9.88	27.38
	1200	230/460	326HP	M902B	326TTFS16377		\$11,324	S5	93.0	77.0/38.5	788	1000	16.38	35.62
40	3600	230/460	324HP	M904B	324TTFS16011		\$8,468	S5	93.0	94.0/47.0	738	600	16.38	35.62
	1800	230/460	324HP	M905B	324TTFS6041		\$11,064	S5	94.1	95.0/47.5	820	800	16.38	35.62
	1200	230/460	364HP	M906B	364TTFS16087		\$14,825	S5	94.1	100/50.0	934	1000	16.38	37.61
	900	230/460	365HP	M907B	365TTFS16105		\$17,142	S5	91.7	106/53.0	1112	1100	16.38	37.61
50	3600	230/460	326HP	M908B	—		\$9,665	S5	93.0	112/56.0	900	700	16.38	34.59
	1800	230/460	326HP	M909B	326TTFS16037		\$11,493	S5	94.5	120/60.0	825	800	16.38	34.59
	1200	230/460	365HP	M910B	365TTFS16088		\$17,479	S5	94.5	123/61.5	998	1000	16.38	37.61

Catalog numbers (Cat No.) highlighted in bold blue are premium efficient.

Blue shaded areas are cast iron frames.

Continued on next page.

VERTICAL SOLID SHAFT P-BASE MOTORS

THREE PHASE, TOTALLY ENCLOSED MOTORS

HP	RPM	VOLTS	FRAME	CAT. NO.	MODEL NO.	STOCK	LIST PRICE	MULT. SYMB.	NOM. EFF.	FL. AMPS	WT.	DOWN THRUST.	BASE DIA.	"C" DIM.
60	3600	230/460	364HP	M912B	364TTFS16008		\$12,482	S5	94.5	134/67.0	1064	600	16.38	37.61
	1800	230/460	364HP	M913B	364TTFS6059		\$13,617	S5	95.0	140/70.0	1116	800	16.38	37.61
	1200	230/460	404HP	M914B	404TTFS16086		\$21,293	S5	94.5	144/72.0	1232	1400	16.38	40.58
75	3600	230/460	365HP	M916B	365TTFS16013		\$15,590	S5	94.5	168/84.0	1059	600	16.38	37.61
	1800	230/460	365HP	M917B	365TTFS16132		\$15,869	S5	95.4	172/86.0	1130	800	16.38	37.61
	1200	230/460	405HP	M918B	405TTFS16082		\$25,041	S5	94.5	180/90.0	1460	1400	16.38	40.58
	900	460	444HP	M919B	444TTFN16103		\$30,143	S5	93.6	102	1889	1600	16.38	43.50
100	3600	230/460	405HP	M920B	405TTFS16004		\$22,453	S5	94.1	224/112	1362	600	16.38	40.58
	1800	230/460	405HP	M921B	405TTFS16129		\$21,379	S5	95.4	226/113	1430	900	16.38	40.58
	1200	460	444HP	M922B	444TTFN16081		\$33,381	S5	95.0	248/124	1865	1400	16.38	43.50
125	3600	460	444HP	M924B	444TTFN16001		\$30,299	S5	95.0	142	1846	600	16.38	43.50
	1800	460	444HP	M925B	444TTFN16045		\$27,750	S5	95.4	146	2122	1000	16.38	43.50
	1200	460	445HP	M926B	445TTFN16091		\$40,354	S5	95.0	155	2248	1400	16.38	43.50
150	3600	460	445HP	M928B	445TTFN16001		\$36,819	S5	95.8	168	2162	600	16.38	43.50
	1800	460	445HP	M929B	445TTFN16361		\$33,894	S5	95.8	170	2292	1000	16.38	43.50
	900	460	449HP	M931B	449TTFS16106		\$71,204	S5	95.4	205	3290	1600	16.38	54.48
200	1800	460	445HP	M933B	445TTFN16359		\$47,365	S5	96.2	226	2490	1000	16.38	43.50

Catalog numbers (Cat No.) highlighted in bold blue are premium efficient.

Blue shaded areas are cast iron frames.

AERATION FAN, FARM / AGRICULTURAL DUTY, SINGLE PHASE MOTORS

TEAO, RIGID BASE MOTORS

APPLICATIONS:

Direct drive vane axial fans. These totally enclosed air over motors must be mounted within the airstream for proper cooling. These aeration fan motors are often used in agricultural applications.

FEATURES:

- Capacitor start design for high starting torque (as noted)
- 1.0 service factor except as noted
- UL recognized and CSA certified
- 18" Leads for ease of connections, Marathon® models only
- 56Z & 143-5TZ have keyway and 1/4" x 20" UNC tapped hole, Marathon models only



SINGLE PHASE

HP	RPM	VOLTS	FRAME	OVER LOAD	CAT. NO.	MODEL NO.	STOCK	LIST PRICE	MULT. SYMB.	FL. AMPS	WT.	"C" DIM.	FOOT NOTES
1/2	3600	115/230	48Z	AUTO	B666	Century®	√	\$397	S1	6.4/3.2	20	10.4	2, N
	3600	115/230	56	AUTO	B220	Century	√	\$397	S1	5.8/2.9	22	11.1	93
3/4	3600	115/230	56Z	AUTO	C1467	5KC37NN3544T	√	\$414	F1	9.8/4.9	20	11.26	2, 10
1	3600	115/230	56Z	AUTO	C1468	5KC49NN2081T	√	\$459	F1	13.0/6.5	26	11.74	2, 10
	3600	115/230	56	AUTO	B222	Century	√	\$476	S1	9.2/4.6	31	12.2	93
1 1/2	3600	115/230	143TZ	AUTO	C1273	5KC49SN8060T	√	\$926	S1	16.4/8.2	35	12.28	2
2	3600	115/230	145TZ	AUTO	C1274	5KCR49TN8058T	√	\$1,133	S1	17.8/8.9	37	12.28	1, 18
3	3600	230	145T	AUTO	C1275	5KCR49ZN8061T	√	\$1,544	S1	13.2	49	13.69	1, 18
	3600	230	145T	T-Stat	K116	Century	√	\$1,544	S1	15.4	44	13.8	2, TS
3~4	3600	230	145T	T-Stat	K112V1	Century	√	\$1,544	S1	12.4-17.0	39	13.8	1, TS

THREE PHASE

HP	RPM	VOLTS	FRAME	OVER LOAD	CAT. NO.	MODEL NO.	STOCK	LIST PRICE	MULT. SYMB.	FL. AMPS	WT.	"C" DIM.	FOOT NOTES
3/4	3600	208-230/460	56	None	H041	Century	√	\$448	S1	2.6-2.4/1.2	24	11.1	
1	3600	208-230/460	56	None	H042	Century	√	\$476	S1	2.8-2.7/1.35	28	11.1	
1 1/2	3600	208-230/460	143T	T-Stat	R180	Century	√	\$553	S1	4.4-4.2/2.1	31	12.1	TS
3~4	3600	230/460	145T	T-Stat	R155	Century	√	\$730	S1	8.4/4.2	34	12.1	TS

ATTIC FAN, SPLIT PHASE MOTORS

OPEN AIR OVER, RESILIENT BASE MOTORS

FEATURES:

- Variable torque on two speed motors
- 48Y frame has 48/56 frame mounting holes
- 56YZ frame with 3" shaft height, 1/2" diameter shaft, and 5/8" adapter with keyway included
- UL recognized and CSA certified
- Auto overload



HP	RPM	VOLTS	FRAME	CAT. NO.	MODEL NO.	STOCK	LIST PRICE	MULT. SYMB.	FL. AMPS	WT.	"C" DIM.	FOOT NOTES
1/3	1800/1200	115	48Y	B402	048S17D7209	√	\$333	F1	5.3/2.9	21	10.31	
	1800		48Y	B400	048S17D997	√	\$220	F1	6.6	14	9.34	
1/2	1800	115	56YZ	B401	056S17D2062	√	\$274	F1	7.8	18	10.47	53

CENTRIFUGAL FAN, SINGLE PHASE MOTORS

DRIPPROOF, RIGID BASE MOTORS

APPLICATIONS:

Direct drive centrifugal fans installed in relatively clean and dry applications

FEATURES:

- Capacitor start/capacitor run design for high starting torque and low amps
- Ball bearings, mechanically locked on shaft end
- Heavy gauge steel frame and base
- 1.15 service factor (unless otherwise noted)
- UL recognized and CSA certified
- Thermostats for thermal overload protection
- 84" leads, rodent screens
- Shaft 1" longer than NEMA® standard for extra clearance



HP	RPM	VOLTS	FRAME	CAT. NO.	MODEL NO.	STOCK	LIST PRICE	MULT. SYMB.	FL. AMPS	WT.	"C" DIM.	FOOT NOTES
5	1800	208-230	184TZ	Z124	184TBDR7369		\$2,058	S1	23.0-21.0	82	16.72	13
7 1/2	1800	208-230	215TZ	Z125	215TBDR7361		\$2,928	S1	35.2	135	19.19	
			215TZ	Z126	215TBDW7362		\$3,090	S1	44.0	158	18.7	
15	1800	230	256TZ	Z127	256TBDX7028		\$3,831	S1	61.0	187	24.06	17

CONDENSER FAN/HEAT PUMP, PSC, OPEN AIR OVER MOTORS

THRU-BOLT, SHAFT UP OR HORIZONTAL MOTORS

APPLICATIONS:

Direct drive condenser fans mounted vertically, shaft up. Models with open brackets should be mounted where they are shielded from rain. These motors need to be mounted within the airflow of the fan for proper cooling.

FEATURES:

- Frame and shaft end bracket enclosed, except X011, X012, and X208 have open frames and X426 has open frame and brackets
- Single and multi-speed models as noted
- Ball bearings
- Weather resistant reversing plug
- 30" long leads
- Shaft with flat, unless otherwise noted
- 60°C ambient (as noted)
- Shaft slinger
- 1-5/8" extended thru-bolts on shaft end, except where noted
- Automatic reset thermal protector
- Lug mount kits and other accessories available, see accessories section
- UL recognized and CSA certified
- Capacitor not included, see accessories section



HP	RPM	VOLTS	FRAME	CAT. NO.	MODEL NO.	STOCK	LIST PRICE	MULT. SYMB.	FL. AMPS	WT.	FRAME LENGTH	SHAFT DIM.	FOOT NOTES
1/4	1625/1	208-230	48Y	X012	048A17O2006	✓	\$234	F1	1.8-1.8	12	4 1/2	1/2 X 6	30, 34, 44
	1625/1	460	48Y	X420	048A17O169	✓	\$314	F1	1.0	12	4	1/2 X 6	34
	1075/2	208-230	48Y	X081	048A11O2031	✓	\$261	F1	1.9-1.9	12	4 1/4	1/2 X 6	
	1075/1	208-230	48Y	X213	048A11O1524	✓	\$223	F1	1.4-1.2	12	4 1/4	1/2 X 6	37, 44
	1075/1	208-230	48Y	X087	048A11O2029	✓	\$212	F1	2.0-2.0	12	4 1/4	1/2 X 6	
	1075/1	460	48Y	X423	048A11O2055	✓	\$242	F1	1.0	13	4 1/4	1/2 X 6	36
	825/1	208-230	48Y	X097	048A8O182	✓	\$314	F1	1.8-1.8	13	4 1/2	1/2 X 6	
1/3	1625/3	208-230	48Y	X011	048A17O2005	✓	\$252	F1	2.3-2.3	14	4 3/4	1/2 X 6	30, 34, 44
	1075/2	208-230	48Y	X083	048A11O2034	✓	\$277	F1	3.0-3.0	18	4 3/4	1/2 X 6	
	1075/1	208-230	48Y	X214	048A11O1525	✓	\$222	F1	2.3-2.6	13	4 1/2	1/2 x 6	45
	1075/1	208-230	48Y	X088	048A11O2032	✓	\$228	F1	3.0-3.0	14	4 3/4	1/2 x 6	
	1075/1	460	48Y	X424	048A11O2054	✓	\$274	F1	1.4	15	4 3/4	1/2 x 6	36
	825/1	208-230	48Y	X086	048A8O2001	✓	\$352	F1	2.4-2.4	17	5 1/4	1/2 x 6	
1/2	1625/1	460	48Y	X422	048A17O172	✓	\$397	F1	1.7	15	5	1/2 x 6	36
	1625/1	575	48Y	X454	048A17O250	✓	\$397	F1	1.35	15	5	1/2 x 6	36
	1075/1	208-230	48Y	X096	048A11O840	✓	\$304	F1	4.2-4.2	18	5 1/2	1/2 x 6	
	1075/1	208-230	48Y	X089	048A11O2035	✓	\$257	F1	4.2-4.2	17	5 1/4	1/2 x 6	
	1075/1	208-230	48Y	X221	048A11O1526	✓	\$269	F1	2.7-2.6	15	5	1/2 x 6	45
	1075/1	460	48Y	X400	048A11O2017	✓	\$309	F1	1.8	16	5	1/2 x 6	35
	1075/1	575	48Y	X453	048A11O1771	✓	\$309	F1	1.15	17	5	1/2 x 6	35
	825/1	208-230	48Y	X098	048A8O181	✓	\$424	F1	3.3-3.3	18	5 1/2	1/2 x 6	
	825/1	208-230	56Z	X208	056A8O5	✓	\$649	F1	3.4-3.4	22	8 5/8	5/8 x 6 w/key/flat	30
3/4	1075/2	208-230	48Y	X085	048A11O678	✓	\$352	F1	5.1-5.1	19	5 1/2	1/2 x 6	
	1075/1	208-230	48Y	X298	048A11O2059	✓	\$295	F1	4.0-4.2	17	5 1/4	1/2 x 6	
	1075/1	208-230	48Y	X090	048A11O2007	✓	\$333	F1	4.6-4.6	17	5 1/2	1/2 x 6	
	1075/1	460	48Y	X099	048A11O2016	✓	\$355	F1	2.5	19	5 1/2	1/2 x 6	34
	1075/1	460	48YZ	X426	048A11O1375	✓	\$430	F1	2.2	19	5 1/2	5/8 x 4.5 w/key	69
	1075/1	575	48Y	X455	048A11O1770	✓	\$355	F1	1.7	19	5 1/2	1/2 x 6	35
1	1075/1	200-230/460	56Z	P190	5KCP49ZN9617T	✓	\$760	F1	6.7-6.8/3.4	40	9	5/8 x 4	

CONDENSER FAN/HEAT PUMP, PSC, OPEN AIR OVER MOTORS

THRU-BOLT MOUNT, SHAFT DOWN MOTORS

APPLICATIONS:

Direct drive condenser fans mounted vertically, shaft down. These motors need to be mounted within the airflow of the fan for proper cooling.

FEATURES:

- Frame and opposite shaft end bracket are enclosed for vertical shaft down mounting
- Weather resistant reversing plug
- 30" long leads
- Shaft slinger
- 1-1/4" Extended thru-bolts on shaft end, except where noted
- Automatic reset thermal protector
- Ball bearings
- UL recognized and CSA certified
- Capacitor not included, see accessories section



HP	RPM	VOLTS	FRAME	CAT. NO.	MODEL NO.	STOCK	LIST PRICE	MULT. SYMB.	FL. AMPS	WT.	FRAME LENGTH	SHAFT DIM.	FOOT NOTES
1/8	825	208-230	48Y	X278	048A8O206	√	\$288	F1	0.9-0.9	11	4 1/4	1/2 X 4 3/4	37, 44
1/6	1075	208-230	48Y	X440	048A11O2065	√	\$190	F1	1.0-0.9	10	4	1/2 X 6	
1/5	1075	208-230	48Y	X216	048A11O1097	√	\$212	F1	1.8-1.6	10	3 3/4	1/2 X 6	37, 44, 60
1/4	1075	208-230	48Y	X441	048A11O2062	√	\$233	F1	1.35-1.35	12	4 1/4	1/2 X 6	
1/3	1075	208-230	48Y	X442	048A11O2064	√	\$249	F1	2.0-1.95	14	4 3/4	1/2 X 6	
	1075	208-230	48Y	X297	048A11T509	√	\$225	F1	1.8-1.8	12	4 1/4	1/2 X 3 3/4	N, 29, 41, 60
1/2	1075	208-230	48Y	X443	048A11O2063	√	\$276	F1	3.9-3.9	18	5 1/4	1/2 X 6	
3/4	1075	208-230	48Y	X444	048A11O1596	√	\$367	F1	4.3-4.7	18	5 1/2	1/2 X 6	

CONDENSER FAN/HEAT PUMP, PSC, OPEN AIR OVER MOTORS

RIGID BASE, SHAFT UP OR HORIZONTAL MOTORS

APPLICATIONS:

Condenser fans, installed outdoors. These motors need to be mounted within the airflow of the fan for proper cooling.

FEATURES:

- Frame and shaft end bracket enclosed
- Heavy gauge steel constructions
- 56Y frame has non-NEMA® BA dimension of 1.97"
- Automatic reset thermal protector
- Flat and keyway on shaft
- Ball bearings
- UL recognized and CSA certified
- Capacitor included on X432, see accessories section to order capacitor for X433



HP	RPM	VOLTS	FRAME	CAT. NO.	MODEL NO.	STOCK	LIST PRICE	MULT. SYMB.	FL. AMPS	WT.	FRAME LENGTH	SHAFT DIM.	FOOT NOTES
3/4	1075	208-230/460	56YZ	X432	056A11O29	√	\$532	F1	4.6-4.4/2.2	22	11.88	5/8 x 4 1/2	36
1	1075	208-230/460	56YZ	X433	056S11O30	√	\$634	F1	5.8-5.4/2.7	27	12.38	5/8 x 4 1/2	

CONDENSER FAN/HEAT PUMP, PSC, AIR OVER MOTORS

48 FRAME, THRU-BOLT, ALL-ANGLE MOTORS

APPLICATIONS:

Direct drive condenser fans for all angle mounting. These motors need to be mounted within the airflow of the fan for proper cooling.

FEATURES:

- Frame and end brackets enclosed
- Single and multi-speed models, as noted
- Ball bearings (except as noted)
- Weather resistant reversing plug
- 30" long leads
- Shaft slinger
- 1-1/2" Thru-bolts on shaft end, 1" thru-bolts on lead end (except as noted)
- Automatic reset thermal protector
- Weep holes with removable plugs on end brackets. Remove bottom plug after installation
- Lug mount kits and other accessories available (see accessories section)
- 60°C ambient, as noted
- UL recognized and CSA certified
- Capacitor not included, see accessories section



HP	RPM	VOLTS	FRAME	CAT. NO.	MODEL NO.	STOCK	LIST PRICE	MULT. SYMB.	FL. AMPS	WT.	FRAME LENGTH	SHAFT DIM.	FOOT NOTES
1/6	1075/2	208-230	48Y	X429	048A11T2020	√	\$255	F1	1.3-1.3	11	4	1/2 x 6	36
	1075/1	208-230	48Y	X411	048A11T2008	√	\$242	F1	1.3-1.3	10	3 3/4	1/2 x 6	
	1075/1	208-230	48Y	X427	048A11T2017		\$242	F1	1.3-1.3	10	3 3/4	1/2 x 6	
	825/1	208-230	48Y	X465	048A8T11002	√	\$255	F1	1.1-1.1	12	4 1/4	1/2 x 6	45
1/4	1625/1	208-230	48Y	X467	048A47T87	√	\$228	F1	2.0-2.0	12	4 1/2	1/2 x 6	36, 44
	1625/2	208-230	48Y	X463	048A17T356	√	\$261	F1	1.4-1.4	13	4 1/2	1/2 x 6	45, 94
	1075/2	208-230	48Y	X430	048A11T463	√	\$277	F1	1.8-1.8	16	4 1/2	1/2 x 6	36
	1075/1	208-230	48Y	X412	048A11T569	√	\$269	F1	1.4-1.4	16	4 1/4	1/2 x 6	45
	1075/1	460	48Y	X456	048A11T578	√	\$277	F1	0.75	15	4 1/2	1/2 x 6	45
	840/1	208-230	48Y	X450	048A8T71	√	\$261	F1	1.9-1.9	17	5 1/4	1/2 x 6	45
1/3	1625/1	208-230	48Y	X466	048A17T86	√	\$250	F1	2.0-2.0	15	5	1/2 x 6	36, 44
	1075/2	208-230	48Y	X415	048A11T2012	√	\$296	F1	2.6-2.6	16	5	1/2 x 6	36
	1075/1	208-230	48Y	X413	048A11T529	√	\$292	F1	1.9-1.9	14	4 3/4	1/2 x 6	45
	1075/1	460	48Y	X457	048A11T579	√	\$295	F1	0.9	17	5	1/2 x 6	36, 45
	825/1	208-230	48Y	X451	048A8T72	√	\$276	F1	2.3-2.3	19	5 3/4	1/2 x 6	34, 45
1/2	1625/1	208-230	48Y	X468	048A17T96	√	\$282	F1	2.9-2.6	16	5 1/4	1/2 x 6	37, 44
	1625/2	208-230	48Y	X464	048A17T359		\$317	F1	3.1-2.9	17	5 1/4	1/2 x 6	45
	1075/2	208-230	48Y	X416	048A11T2013	√	\$325	F1	4.2-4.2	19	5 1/2	1/2 x 6	36
	1075/1	208-230	48Y	X414	048A11T571	√	\$320	F1	2.7-2.7	17	5	1/2 x 6	36, 45
	1075/1	460	48Y	X458	048A11T580	√	\$325	F1	1.4	20	5 1/2	1/2 x 6	36, 45
	825/1	208-230	48Y	X452	048A8T73	√	\$339	F1	3.1	21	6 1/4	1/2 x 6	45
3/4	1075/1	208-230	48Y	X469	048A11T276	√	\$282	F1	4.2-3.65	21	6	1/2 x 6	37, 63
	1075/1	460	48Y	X459	048A11T581	√	\$367	F1	2.1	23	6	1/2 x 6	32, 45
1	1075/1	460	48Y	X462	048A11T619	√	\$434	F1	3.4	27	7 1/4	1/2 x 6	32, 45

COMMERCIAL CONDENSER FAN/HEAT PUMP, PSC MOTORS

RESILIENT BASE, SHAFT UP OR HORIZONTAL MOTORS

APPLICATIONS:

Condenser fans, installed outdoors. These motors need to be mounted within the airflow of the fan for proper cooling.

FEATURES:

- Frame and shaft end bracket enclosed
- Automatic reset thermal protector
- UL recognized and CSA certified
- Ball bearings
- Capacitor included



HP	RPM	VOLTS	FRAME	CAT. NO.	MODEL NO.	STOCK	LIST PRICE	MULT. SYMB.	FL. AMPS	WT.	FRAME LENGTH	SHAFT DIM.	FOOT NOTES
1/2	1075	208-230/460	48YZ	X431	048A11O1461	√	\$419	F1	3.0-3.0/1.5	19	11.94	1/2 x 4 1/2	

CONDENSER FAN/HEAT PUMP MOTORS

56 FRAME, RESILIENT RING, THRU-BOLT MOTORS

APPLICATIONS:

Direct drive condenser fans mounted vertically, shaft up, or horizontal. These motors need to be mounted within the airflow of the fan for proper cooling.



FEATURES:

- Enclosed shaft end bracket with vented frame
- Ball bearings
- 30" long leads (except P243)
- Shaft slinger
- 60°C ambient, as noted
- Automatic reset thermal protector
- Flat & keyway on shaft
- UL recognized and CSA certified
- Capacitor not included, see accessories section

PSC, OPEN AIR OVER, SHAFT UP

HP	RPM	VOLTS	FRAME	CAT. NO.	MODEL NO.	STOCK	LIST PRICE	MULT. SYMB.	FL. AMPS	WT.	FRAME LENGTH	SHAFT DIM.	FOOT NOTES
3/4	1075	208-230/460	56Y	X207	056A1105311	√	\$601	F1	3.9-3.6/1.8	31	8 1/4	5/8 x 6	37, 45
1	1075	208-230/460	56Y	X206	056A1105310	√	\$634	F1	5.4-5.2/2.6	34	10 1/16	5/8 x 6	37
1 1/2	1075	208-230/460	56Y	X271	056A1105305	√	\$724	F1	7.7-7.6/3.8	43	9 3/4	5/8 x 6	34, 45

PSC, DRIPPROOF

HP	RPM	VOLTS	FRAME	CAT. NO.	MODEL NO.	STOCK	LIST PRICE	MULT. SYMB.	FL. AMPS	WT.	FRAME LENGTH	SHAFT DIM.	FOOT NOTES
1/2	825/1	115/208-230	56Y	P245	5KCP49PN9812S	√	\$818	F1	6.2/3.8-3.1	31	13.66	5/8 X 6	
3/4	1075/1	208-230/460	56Y	P243	5KCP49RN9611S	√	\$775	F1	4.9-3.8/1.9	33	13.66	5/8 X 6	
	825/1	208-230	56Y	P246	5KCP49UN9811S	√	\$886	F1	5.8-5.6	32	14.47	5/8 X 6	
1	1075/3	115	56Y	P184	5KCP49UN9612S	√	\$848	F1	10.8	40	14.87	5/8 X 6	
	1075/3	200-230	56Y	P185	5KCP49UN9614S	√	\$848	F1	4.8-5.0	34	14.87	5/8 X 6	
	1075/1	208-230/460	56Y	P244	5KCP49UN9613S	√	\$814	F1	6.3-5.0/2.5	40	14.47	5/8 X 6	
	825/1	208-230/460	56Y	P180	5KCP49VN9813S	√	\$934	F1	6.3-6.4/3.2	39	11.24	5/8 x 6	

CONDENSER FAN MOTORS

56 FRAME MOTORS

FEATURES:

- Capacitor mounted (single phase)
- TEAO except:
 - › H768 & C663 are ODP
 - › C662 is OAO
- 60°C ambient, as noted
- Automatic reset thermal protector
- Ball bearings
- Flat & keyway on shaft except for:
 - › H964 shaft is keyed only
 - › C662 and C663 shafts are flat only



SINGLE PHASE, PSC, RESILIENT BASE

HP	RPM	VOLTS	FRAME	CAT. NO.	MODEL NO.	STOCK	LIST PRICE	MULT. SYMB.	FL. AMPS	WT.	FRAME LENGTH	SHAFT DIM.	FOOT NOTES
3/4	1075	208-230/460	56Y	C662	Century®	√	\$1029	F1	4.3-4.2/2.1	32	10 1/4	5/8 x 2.5	45
3/4 SPL	1100	208-230/460	56Z	C663	Century	√	\$1174	F1	4.8-4.2/2.1	39	10 1/4	5/8 x 4	58, 101
1	1075	208-230/460	56Y	FB1106TE	Century	√	\$925	F1	4.2/2.3	41	11 1/3	5/8 x 6	34
1 1/2	1075	208-230/460	56Y	FB1156TE	Century	√	\$694	F1	6.6/3.3	47	12 1/10	5/8 x 6	34

THREE PHASE, RIGID BASE

HP	RPM	VOLTS	FRAME	CAT. NO.	MODEL NO.	STOCK	LIST PRICE	MULT. SYMB.	FL. AMPS	WT.	FRAME LENGTH	SHAFT DIM.	FOOT NOTES
1	1140	200-230/460	56Y	H685	Century	√	\$1050	F1	4.2-3.8/1.9	34	9 1/3	5/8 x 3.56	45
	1140	575	56Z	H964	Century	√	\$977	F1	1.4	32	10 1/4	5/8 x 3.56	45
1 1/2	1140	200-230/460	56Y	H768	Century	√	\$839	F1	6.0-5.8/3.0	33	10 4/5	5/8 x 6	45

COMMERCIAL CONDENSER FAN/HEAT PUMP, PSC MOTORS

RESILIENT RING, SHAFT UP MOTORS

APPLICATIONS:

Condenser fans, installed outdoors. These motors need to be mounted within the airflow of the fan for proper cooling.



FEATURES:

- Double sealed ball bearing
- Automatic reset thermal protector
- Quick-connect design
- 1" (minimum) extended thru bolts
- Resilient mounting rings supplied (except for C770, C081, C771)
- Capacitor not included
- 1.0 service factor
- 60° C ambient (except C490, C785, C786 are 40° C)
- 5/8" Dia. shaft with both keyway and flat

OPEN AIR OVER

HP	RPM	VOLTS	FRAME	CAT. NO.	MODEL NO.	STOCK	LIST PRICE	MULT. SYMB.	FL. AMPS	WT.	FRAME LENGTH	SHAFT DIM.	FOOT NOTES
1/2	850	115/208-230	56Y	C784	Century®	√	\$810	F1	4.0-3.3/6.6	36	10.88	5/8 x 6	
	1075	200-230/460	56Y	C513V1	Century	√	\$768	F1	2.6-2.5/1.25	30	10.31	5/8 x 6	
3/4	825	200-230/460	56Y	C660V1	Century	√	\$903	F1	5.3-5.2/2.6	36	11.31	5/8 x 6	
	1075	200-230/460	56Y	C661V1	Century	√	\$775	F1	4.0-3.8/1.9	32	10.31	5/8 x 6	
1	825	200-230/460	56Z	C490	Century	√	\$1083	F1	7.2-6.8/3.4	41	11.50	5/8 x 6	43, 64
	1075	200-230/460	56Y	C770	Century	√	\$738	F1	4.8/2.4	35	10.81	5/8 x 6	
	1075	200-230/460	56Y	C770V1	Century	√	\$734	F1	4.8/2.4	35	10.81	5/8 x 6	
	1075	200-230/460	56Y	FY1106V1	Century	√	\$814	F1	5.0/2.5	32	10.34	5/8 x 6	68
	1075	575	56Y	C081	Century	√	\$755	F1	2.2	42	11.31	5/8 x 6	
1 1/2	1075	200-230/460	56Y	C771	Century	√	\$845	F1	6.6/3.3	46	12.00	5/8 x 6	

TEAO

HP	RPM	VOLTS	FRAME	CAT. NO.	MODEL NO.	STOCK	LIST PRICE	MULT. SYMB.	FL. AMPS	WT.	FRAME LENGTH	SHAFT DIM.	FOOT NOTES
1	1075	208-230/460	56Y	C785	Century	√	\$735	F1	4.2/2.3	40	11.38	5/8 x 6	
1 1/2	1075	208-230/460	56Y	C786	Century	√	\$844	F1	6.6/3.3	44	12.13	5/8 x 6	

COMMERCIAL CONDENSER FAN/HEAT PUMP, PSC MOTORS

OPEN AIR OVER, BELLY BAND, SHAFT UP MOTORS

APPLICATIONS:

Heavy duty design for commercial direct drive condenser fans mounted vertically, shaft up. These motors need to be mounted within the airflow of the fan for proper cooling.

FEATURES:

- Unique rain shield fits over shaft to protect motor in vertical shaft up position
- Shaft with flat, unless otherwise noted
- Automatic reset thermal protector
- UL recognized and CSA certified
- Capacitor not included, see accessories section
- 60°C ambient, as noted
- Shaft slinger
- Ball bearings



HP	RPM	VOLTS	FRAME	CAT. NO.	MODEL NO.	STOCK	LIST PRICE	MULT. SYMB.	F.L. AMPS	WT.	FRAME LENGTH	SHAFT DIM.	FOOT NOTES
0.4	1075	200-230/460	48Y	X445	048A11O1732		\$325	F1	3.0-2.8/1.4	29	5 1/2	1/2 x 4	
0.6	1075	200-230/460	48Y	X446	048A11O1643	√	\$359	F1	3.0-3.6/1.8	20	6 7/8	1/2 x 4	
0.8	1075	200-230/460	48Y	P193	5KCP39SNB480S		\$402	F1	4.0/2.0	21	14 1/5	1/2 x 2 3/4	
	1075	200-230/460	48Y	P194	5KCP39SNB481S		\$480	F1	4.0/2.0	21	9 1/3	5/8 x 4 7/8	
	1075	200-230/460	48Y	X447	048A11O1642	√	\$480	F1	5.0-4.4/2.2	27	8 3/4	1/2 x 4	45
1	1075	200-230/460	48Y	P195	5KCP39SNB482S	√	\$518	F1	5.6/2.8	21	10 5/8	5/8 x 5 1/4 w/key/flat	
	1075	200-230/460	56Y	X448	056A11O5314	√	\$518	F1	6.0-5.2/2.6	33	8 3/4	5/8 x 4 w/key/flat	45
	1075	575	56Y	P196	5KCP39TNB763T	√	\$518	F1	2.6	22	10 1/4	1/2 x 5 1/4	
1.5	1075	200-230/460	56Y	P197	5KCP39UNB767T	√	\$594	F1	8.1-7.8/3.9	23	10 1/4	5/8 spcl.	d
	1075	200-230/460	56Y	X449	056A11O5315		\$594	F1	7.0-7.0/3.5	39	9 1/4	5/8 x 4	45
	1075	575	56Y	P198	5KCP39UNB764T	√	\$594	F1	3.5	23	10 1/4	1/2 x 5 1/4	

COMMERCIAL CONDENSER FAN/HEAT PUMP, THREE PHASE MOTORS

OPEN AIR OVER, RIGID BASE, SHAFT UP OR HORIZONTAL MOTORS

APPLICATIONS:

Commercial condenser fans may be installed outdoors. These motors need to be mounted within the airflow of the fan for proper cooling.

FEATURES:

- 70°C ambient (except as noted)
- Enclosed shaft end bracket, vented frame
- Continuous duty, air over
- Automatic reset thermal protector
- Shaft slinger
- Threaded lead exit
- Nameplated 60/50 hertz 190/380 volts, at next lower HP
- Double sealed ball bearings
- Flat and keyway on shaft
- Patented VCD™ - Voltage Change Device (as noted)
- Ball bearings
- UL recognized and CSA certified



As
Noted



As
Noted



HP	RPM	VOLTS	FRAME	CAT. NO.	MODEL NO.	STOCK	LIST PRICE	MULT. SYMB.	F.L. AMPS	WT.	FRAME LENGTH	SHAFT DIM.	FOOT NOTES
1/3	1140	208-230/460	56Z	X532	056T11O11001	√	\$566	F1	1.8-1.8/0.9	22	13.37	1/2 x 5	45, 50
1/2	1140	208-230/460	56Z	X533	056T11O11002	√	\$609	F1	2.1-2.0/1.0	20	13.37	5/8 x 5	45, 50
	1140	208-230/460	56Z	X533-P	056T11O11005	√	\$709	F1	2.1-2.0/1.0	20	13.31	5/8 x 5	P, 45, 50
	850	208-230/460	56HZ	X529	056T8O5531	√	\$872	F1	2.9-3.0/1.5	31	14.68	5/8 x 5	VC, 5
	850	208-230/460	56HZ	X529-P	056T8O15530	√	\$972	F1	2.6-3/1.5	31	15.01	5/8 x 5	P, VC, 5
3/4	1140	208-230/460	56HZ	X512	056T11O15511		\$677	F1	2.7-3.0/1.5	27	14.18	5/8 x 5	VC, 5
	1140	208-230/460	56HZ	X512-P	056T11O15572	√	\$777	F1	3.2-3.2/1.6	27	14.51	5/8 x 5	P, VC, 5
1	1140	208-230/460	56HZ	K1485	5K49RN6118S		\$693	F1	4.2-4.0/2.0	33	16.02	5/8 X 6	46
	1140	208-230/460	56HZ	X513	056T11O5305	√	\$735	F1	4.1-4.2/2.1	29	14.68	5/8 x 5	VC, 5
	1140	208-230/460	56HZ	X513-P	056T11O15573	√	\$835	F1	4.0-4.2/2.1	29	15.01	5/8 x 5	P, VC, 5
	850	208-230/460	56HZ	X528	056T8O5306	√	\$979	F1	5.1-5.3/2.65	49	17.06	5/8 x 5	VC, 5
	850	208-230/460	56HZ	X528-P	056T8O15529	√	\$1,079	F1	4.8-5.3/2.65	49	17.06	5/8 x 5	P, VC, 5
1 1/2	1140	208-230/460	56HZ	K1486	5K48TN6119S		\$754	F1	5.1-5.0/2.5	38	16.77	5/8 X 6	46
	1140	208-230/460	56HZ	X523	056T11O5306	√	\$798	F1	5.4-5.4/2.7	36	15.68	5/8 x 5	VC, 5
	1140	208-230/460	56HZ	X523-P	056T11O15569	√	\$898	F1	5.4-5.4/2.7	36	16.01	5/8 x 5	P, VC, 5
	850	208-230/460	56HZ	X531	056T8O15504	√	\$1,065	F1	7.0-7.0/3.5	47	16.68	5/8 x 5	VC, 5
	850	208-230/460	56HZ	X531-P	056T8O15534	√	\$1,165	F1	7.0-7.0/3.5	47	17.01	5/8 x 5	P, VC, 5
2	1140	208-230/460	56HZ	X525	056T11O5310	√	\$865	F1	7.2-6.8/3.4	47	16.68	5/8 x 5	VC, 5

CONDENSER FAN/HEAT PUMP, THREE PHASE MOTORS

OPEN AIR OVER, BELLY BAND/RESILIENT RING MOTORS

APPLICATIONS:

Commercial condenser fans may be installed outdoors. These motors need to be mounted within the airflow of the fan for proper cooling.

FEATURES:

- 70°C ambient (except as noted)
- Enclosed shaft end bracket, vented frame
- Automatic reset thermal protector
- Nameplate 60/50 hertz 190/380 volts, at next lower HP (except as noted)
- Double sealed ball bearings
- 5/8" Dia. x 5" long shaft with flat and keyway
- Ball bearings
- Threaded lead exit
- Patented VCD™ - Voltage Change Device



- 4 locating screws 90 degrees apart, 3.33" from outer edge of shaft slinger
- Hubs on both ends will accept resilient base kits, see accessories section (except X524 and X526 - horizontal only)
- UL recognized and CSA certified
- External shaft slinger on all, internal slinger on 5K models

HP	RPM	VOLTS	FRAME	CAT. NO.	MODEL NO.	STOCK	LIST PRICE	MULT. SYMB.	F.L. AMPS	WT.	FRAME LENGTH	FOOT NOTES
1/3	850	208-230/460	56Y	X511	056T8O5303	√	\$786	F1	2.3-2.5/1.25	23	9.50	VC
1/2	1140	200-230/460	56Y	X500	056T11O5300	√	\$625	F1	2.4-2.7/1.35	21	9.00	VC
	1140	200-230/460	56Y	X500-P	056T11O15575	√	\$725	F1	2.4-2.7/1.35	21	9.00	P,VC
	1140	575	56Y	K1500	5K49MN6432S	√	\$744	F1	1.0	27	9.49	33, 46
3/4	1140	208-230/460	56Y	K378	5K46LN6033S		\$653	F1	3.0-3.4/1.7	25	8.89	46
	1140	200-230/460	56Y	X501	056T11O5301	√	\$692	F1	3.1-3.2/1.6	24	9.50	VC
	1140	200-230/460	56Y	X501-P	056T11O15574	√	\$792	F1	3.2-3.2/1.6	24	9.50	P,VC
	1140	575	56Y	K1505	5K46LN6428S	√	\$781	F1	1.5	25	8.89	33, 46
	850	208-230/460	56Y	X506	056T8O5301		\$915	F1	3.6-3.6/1.8	39	11.00	VC
	850	208-230/460	56Y	X506-P	056T8O15531	√	\$1,015	F1	3.6-3.6/1.8	39	11.00	P,VC
1	1140	208-230/460	56Y	K379	5K49RN6034S		\$684	F1	4.2-4.0/2.0	33	10.02	46
	1140	200-230/460	56Y	X502	056T11O5302	√	\$725	F1	4.0-4.2/2.1	28	10.00	VC
	1140	200-230/460	56Y	X502-P	056T11O15571	√	\$825	F1	4.0-4.2/2.1	28	10.00	P,VC
	1140	575	56Y	X522	056T11O5308	√	\$725	F1	1.7	28	10.00	70
	1140	575	56Y	K1510	5K49RN6429S		\$681	F1	1.6	33	16.02	33, 46
	850	208-230/460	56Y	K1482	5K48WN3013S		\$897	F1	5.1-5.2/2.6	44	10.77	46
	850	200-230/460	56Y	X507	056T8O5302	√	\$951	F1	5.3-5.3/2.6	46	12.00	VC
	850	200-230/460	56Y	X507-P	056T8O15532	√	\$1,051	F1	5.3-5.3/2.65	46	12.00	P,VC
	850	575	56Y	K1511	5K48WN3181S		\$897	F1	2.0	44	10.77	33, 46
	850	575	56Y	X527	056T8O5304	√	\$897	F1	2.1	46	12.00	70
	1 1/2	1140	200-230/460	56Y	X503	056T11O5303	√	\$792	F1	5.5-5.4/2.7	35	11.00
1140	200-230/460	56Y	X503-P	056T11O15570	√	\$892	F1	5.5-5.4/2.7	35	11.00	P,VC	
1140	575	56Y	X524	056T11O5307	√	\$792	F1	2.2	35	11.00	73	
1140	575	56Y	K1515	5K48TN6430S		\$744	F1	2.2	38	10.77	33, 46	
850	208-230/460	56Y	X530	056T8O5307	√	\$1,025	F1	7.5-6.8/3.4	47	11.25	VC	
850	208-230/460	56Y	X530-P	056T8O15533	√	\$1,125	F1	7.0-6.8/3.4	47	12.00	P,VC	
2	1140	208-230/460	56Y	X509	056T11O5304	√	\$859	F1	7.2-6.8/3.4	46	12.00	VC
	1140	575	56Y	K1520	5K49ZN6433S		\$792	F1	2.5	49	11.97	33, 46
	1140	575	56Y	X526	056T11O5309	√	\$859	F1	2.7	45	11.63	73

SHAFT UP WITH FAN CANOPY / RAINSHIELD

HP	RPM	VOLTS	FRAME	CAT. NO.	MODEL NO.	STOCK	LIST PRICE	MULT. SYMB.	F.L. AMPS	WT.	FRAME LENGTH	FOOT NOTES
1/2	1140	200-230/460	48Y	K1403	5K36PN345S	√	\$741	F1	2.2-2.6/1.3	20	7.95	46
3/4	1140	200-230/460	48Y	K1404	5K38SN267S	√	\$779	F1	3.3-3.8/1.9	24	8.95	46
	1140	575	48Y	K1405	5K39SNB765T	√	\$827	F1	1.5	21	8.50	46
1	1140	200-230/460	48Y	K1402	5K39SNB505S	√	\$859	F1	4.4-4.0/2.0	21	8.50	46
1 1/2	1140	200-230/460	48Y	K1407	5K39SNB587S	√	\$940	F1	6.0-5.8/2.9	21	10.63	46

CONDENSER FAN CONTINUOUS DUTY, AIR OVER MOTORS

THREE PHASE, 56 FRAME MOTORS

APPLICATIONS:

Commercial condenser fans may be installed outdoors. These motors need to be mounted within the airflow of the fan for proper cooling.

FEATURES:

- 70°C ambient (except as noted)
- Quick-Connect design
- Automatic reset thermal protector
- Reversible
- Double sealed ball bearings
- 1.0 service factor, except as noted



TEAO (BASELESS)

HP	RPM	VOLTS	FRAME	CAT. NO.	MODEL NO.	STOCK	LIST PRICE	MULT. SYMB.	FL. AMPS	WT.	FRAME LENGTH	FOOT NOTES
1/2	1140	575	56Y	H977	Century®	√	\$716	F1	0.80	25	12.56	45, 136
1	1140/940	208-230/460	56Y	H696	Century	√	\$931	F1	1.8/3.7-3.6	34	15.63	18, 68
	1140	200-230/460	56Y	FY3106	Century	√	\$931	F1	5.7/2.9	35	15.42	35, 45, 68
1 1/2	1140	200-230/460	56Y	FY3156	Century	√	\$1009	F1	5.4/2.7	38	14.84	36, 45, 68
	1140	200-230/460	56Y	H697	Century	√	\$1009	F1	2.6/5.4-5.2	39	17.44	18
2	1140	208-230/460	56Y	H698	Century	√	\$1092	F1	3.1/6.8-6.2	44	15.63	

ODP (BASELESS)

HP	RPM	VOLTS	FRAME	CAT. NO.	MODEL NO.	STOCK	LIST PRICE	MULT. SYMB.	FL. AMPS	WT.	FRAME LENGTH	FOOT NOTES
1 1/2	1140	200-230/460	56Y	H767V1	Century	√	\$793	F1	2.5/5.1-5.0	34	17.02	45
2	1140	208-230/460	56Y	H699	Century	√	\$864	F1	3.1/6.8-6.2	44	18.19	

OPEN AIR OVER (BASELESS)

HP	RPM	VOLTS	FRAME	CAT. NO.	MODEL NO.	STOCK	LIST PRICE	MULT. SYMB.	FL. AMPS	WT.	FRAME LENGTH	FOOT NOTES
1/2	1140	200-230/460	56Y	H564	Century	√	\$631	F1	1.3/2.8-2.6	27	16.31	45
3/4	1140	200-230/460	56Y	H567	Century	√	\$696	F1	1.5/2.8-3.0	26	16.31	45
1	850	200-230/460	56Y	OKR1503	Century	√	\$995	F1	2.0/4.4-4.0	34	13.56	45, 136
	850	200-230/460	56Y	H686	Century	√	\$977	F1	2.0/4.4-4.0	32	14.24	45, 136
	850	575	56Y	H962	Century	√	\$930	F1	1.6	32	13.56	45, 136
	1140	200-230/460	56Y	H667V1	Century	√	\$725	F1	2.3/4.3-4.6	34	16.52	45
	1140	575	56Y	H671	Century	√	\$746	F1	2.0	32	16.31	45
1 1/2	1140	575	56Y	H963	Century	√	\$859	F1	2.3	35	16.81	45

OPEN AIR OVER (WITH BASE)

ADDITIONAL FEATURE: Juggernaut® Inverter Duty Motor

HP	RPM	VOLTS	FRAME	CAT. NO.	MODEL NO.	STOCK	LIST PRICE	MULT. SYMB.	FL. AMPS	WT.	FRAME LENGTH	FOOT NOTES
1/2	1140	200-230/460	56HZ	H1055A	Century	√	\$647	F1	1.3/2.8-2.6	44	16.09	6
3/4	1140	200-230/460	56HZ	H1056A	Century	√	\$713	F1	1.5/2.8-3.0	28	16.20	6
1	850	208-230/460	56HZ	H1053AV1	Century	√	\$1002	F1	2.7/5.4-5.1	46	18.85	6
	850	208-230/460	56HZ	H1053RB	Century	√	\$1002	F1	2.6/5.2-5.0	43	18.32	82
	1140	208-230/460	56HZ	H1050RBV1	Century	√	\$799	F1	2.0/4.0-3.8	30	16.02	82
	1140	208-230/460	56HZ	H1050AV1	Century	√	\$798	F1	2.0/4.0-3.8	29	16.35	6
	1 1/2	850	208-230/460	56HZ	H1054AV1	Century	√	\$1,058	F1	3.3/5.7-5.9	47	18.85
1 1/2	850	208-230/460	56HZ	H1054RBV1	Century	√	\$1,065	F1	3.3/5.7-5.9	47	18.52	82
	1140	208-230/460	56HZ	H1051A	Century	√	\$814	F1	2.9/5.8-5.8	38	17.32	6
	1140	208-230/460	56HZ	H1051RB	Century	√	\$814	F1	2.9/5.8-5.8	38	17.32	82
	2	1140	208-230/460	56HZ	H1052AV1	Century	√	\$887	F1	3.5/7.0-7.0	45	18.34
2	1140	208-230/460	56HZ	H1052RBV1	Century	√	\$887	F1	3.5/7.0-7.0	45	18.01	82

EVAPORATIVE COOLER MOTORS, SINGLE PHASE MOTORS

DRIPPROOF MOTORS (SINGLE AND TWO-SPEED)

APPLICATIONS:

Belt driven evaporative coolers. Readily acknowledged as a leading motor option for residential and commercial evaporative cooler applications, Century® motors offer moisture resistant features including plated hardware and switch parts, fungus treatment and double dip varnish treatment. These features provide the best buy for the customer.



FEATURES:

- Brass current carrying
- Single and two speed
- ODP (except as noted)
- Continuous filtration of oil
- Electro-zinc encapsulating varnish
- Reversible rotation (as noted)
- Heavy magnet wire insulation
- Moisture resistant terminal board
- Base not included (except as noted)
- Base 805C678H16 and clamps 165A674A01 available to order, will fit models with a "C" Dim. of 9.44 or 9.45
- Electro zinc plated governor parts, dust caps and terminal board cover
- Auto protector

SPLIT PHASE

HP	RPM	SPEEDS	VOLTS	FRAME	CAT. NO.	MODEL NO.	STOCK	LIST PRICE	MULT. SYMB.	F.L. AMPS	WT.	"C" DIM.	FOOT NOTES
1/3	1725	1	115	56Z	VB2034	Century®	√	\$208	F1	6.5	13	9.45	16, 119
	1725	1	115	56Z	VB2034B	Century	√	\$223	F1	6.5	15	9.45	16, 130, 141
1/3~1/10	1725/1140	2	115	56Z	SVB2034	Century	√	\$255	F1	6.5/3.6	14	9.45	16, 119
	1725/1140	2	115	56Z	SVB2034B	Century	√	\$268	F1	6.9/4.0	19	9.45	16, 130, 141
1/2	1725	1	115	56Z	VB2054	Century	√	\$247	F1	7.8	15	9.45	16, 119
	1725	1	115	56Z	VB2054B	Century	√	\$258	F1	7.8	6	9.45	16, 130, 141
	1725	1	115	56Z	OTEB2054A	Century	√	\$415	F1	8.0	17	8.94	15, 129
1/2~1/6	1725/1140	2	115	56Z	SVB2054	Century	√	\$276	F1	8.5/4.1	17	9.45	16, 119
	1725/1140	2	230	56Z	SVB2054H	Century	√	\$280	F1	4.4	17	9.45	16, 119
1/2~1/4	1725/1140	1	115	56Z	SV2054BV2L	Century	√	\$334	F1	8.0/6.0	24	10.45	47, 57
3/4	1725	1	115	56Z	VB2074	Century	√	\$306	F1	10.6	15	9.45	16, 119
	1725	1	115	56Z	VB2074B	Century	√	\$347	F1	10.6	18	9.86	16, 141
3/4~1/4	1725/1140	2	115	56Z	SVB2074	Century	√	\$380	F1	10.5/5.0	22	9.45	16, 119
	1725/1140	2	230	56Z	SVB2074H	Century	√	\$443	F1	5.6/2.8	22	9.45	16, 119
3/4~1/3	1725/1140	2	115	56	SVB2074BV1	Century	√	\$376	F1	11.2/7.0	23	9.86	d, 47, 141

CAPACITOR START

HP	RPM	SPEEDS	VOLTS	FRAME	CAT. NO.	MODEL NO.	STOCK	LIST PRICE	MULT. SYMB.	F.L. AMPS	WT.	"C" DIM.	FOOT NOTES
1	1725/1425	1	115/208-230	56	V1104BL	Century	√	\$576	F1	14.4/6.6-7.2	32	11.8	47, 57
1~1/3	1725/1140	1	115	56Z	SV2104L	Century	√	\$597	F1	12.7/7.6	33	12.1	16, 47, 57
	1725/1140	2	115	56Z	SV2104V1L1	Century	√	\$606	F1	12.7/7.6	35	12.1	47, 57
	1725/1140	2	230	56Z	SV2104HL	Century	√	\$586	F1	6.4/3.9	33	12.1	16, 47, 57
	1725/1140	2	230	56Z	SV2104HV2	Century	√	\$596	F1	6.4/3.9	33	12.1	47, 57
1 1/2	1725	1	115/230	56Z	V1154B	Century	√	\$595	F1	15.0/7.5	42	13.8	11, 47, 141
2	1725	1	115/230	56Z	V1204B	Century	√	\$663	F1	18.0/9.0	36	14.3	11, 47, 141

FAN AND BLOWER - DIRECT DRIVE, PSC MOTORS

OPEN AIR OVER, RESILIENT RING, THRU-BOLT MOUNT MOTORS

FEATURES:

- Open frames and brackets (except X011 and X012) have enclosed shaft end bracket
- Single and multi-speed models as noted
- Grommeted lead exit
- Weather resistant reversing plug
- 2-1/4" resilient ring mounting except where noted (base not included, see accessories section)
- 2 1/2" adapter rings supplied, shipped loose in box
- Extended thru-bolts on shaft end
- 30" long leads
- Automatic reset thermal protector
- Ball bearings
- UL recognized and CSA certified
- Capacitor not included, see accessories section

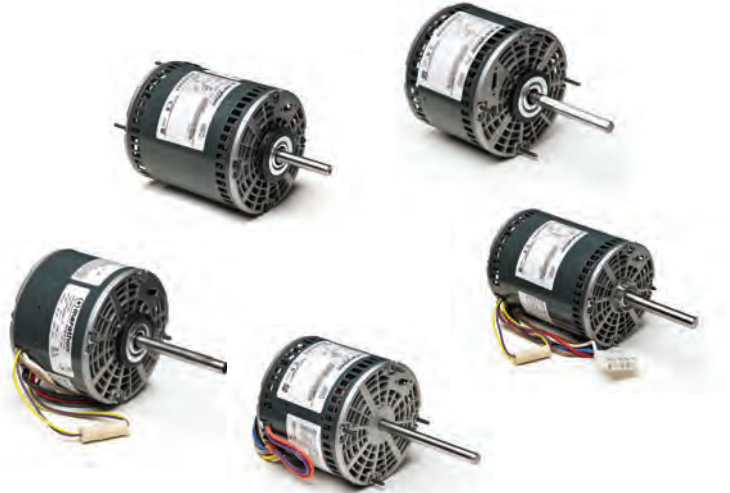

HP	RPM	VOLTS	FRAME	CAT. NO.	MODEL NO.	STOCK	LIST PRICE	MULT. SYMB.	FL. AMPS	WT.	FRAME LENGTH	SHAFT DIM.	FOOT NOTES
1/5	1075/3	115	48Y	X219	048A11O2047	✓	\$210	F1	3.5	11	4	1/2 x 4	39
1/4	1625/3	115	48Y	X013	048A17O152	✓	\$231	F1	2.9	12	5	1/2 x 4	32
	1625/3	208-230	48Y	X014	048A17O154	✓	\$234	F1	1.8-1.35	11	4 1/4	1/2 x 4	32
	1625/1	208-230	48Y	X012	048A17O2006	✓	\$234	F1	1.8-1.8	12	4 1/2	1/2 x 6	34, 44
	1075/3	115	48Y	X000	048A11O1798	✓	\$222	F1	3.4	12	4 1/4	1/2 x 4	32
	1075/3	208-230	48Y	X001	048A11O1799	✓	\$228	F1	1.5-1.5	12	4 1/2	1/2 x 4	32
	1075/3	277	48Y	X018	048A11O1350	✓	\$237	F1	1.6	11	4 1/4	1/2 x 4	32
	1075/1	208-230	48Y	X006	048A11O2001	✓	\$218	F1	2.0-2.0	11	4 1/4	1/2 x 4	32
	1075/1	208-230	48Y	X417	048A11O2051	✓	\$233	F1	2.0-2.2	13	4 1/4	1/2 x 6	51, 116
	1/3	1625/3	115	48Y	X015	048A17O151	✓	\$245	F1	4.0	13	4 3/4	1/2 x 4
1625/3		208-230	48Y	X011	048A17O2005	✓	\$252	F1	2.3-2.3	14	4 3/4	1/2 x 6	34, 44
1075/4		115	48Y	X236	048A11O699	✓	\$276	F1	6.4	16	4 3/4	1/2 x 6	39
1075/4		208-230	48Y	X237	048A11O694	✓	\$281	F1	4.8-4.8	16	5 1/4	1/2 x 6	39
1075/3		115	48Y	X002	048A11O1769	✓	\$237	F1	4.6	14	4 3/4	1/2 x 4	32
1075/3		208-230	48Y	X003	048A11OB2042	✓	\$242	F1	3.3-3.3	14	4 3/4	1/2 x 4	32
1075/3		277	48Y	X019	048A11O1351	✓	\$253	F1	2.7	15	4 3/4	1/2 x 4	32
1075/2		460	48Y	X037	048A11O1876	✓	\$477	F1	1.0	14	4 3/4	1/2 x 6	51
1075/1		208-230	48Y	X418	048A11O2052	✓	\$247	F1	3.1-3.1	14	4 1/2	1/2 x 6	51, 116
825/1		230	48Y	X209	048A8O183	✓	\$303	F1	2.8	17	5 3/4	1/2 x 5 1/2	34, 43
1/2	1625/3	115	48Y	X016	048A17O153	✓	\$274	F1	5.0	16	5 1/4	1/2 x 4	32
	1625/3	208-230	48Y	X017	048A17O155	✓	\$277	F1	4.1-4.1	16	5 1/4	1/2 x 4	32
	1075/4	115	48Y	X033	048A11O1674	✓	\$231	F1	6.1	15	5	1/2 x 5	31, 73
	1075/3	115	48Y	X004	048A11O1755	✓	\$268	F1	6.2	17	5 1/2	1/2 x 4	32
	1075/3	208-230	48Y	X005	048A11O1756	✓	\$271	F1	2.65-2.6	17	5 1/2	1/2 x 4	32
	1075/3	277	48Y	X020	048A11O1352	✓	\$282	F1	3.6	17	5 1/2	1/2 x 4	32
	1075/1	208-230	48Y	X419	048A11O2053	✓	\$276	F1	4.2	17	5 1/4	1/2 x 6	51, 116
	3/4	1625/3	230	48Y	X022	048A17O174	✓	\$304	F1	3.7	18	5 1/2	1/2 x 5 1/2
1075/4		208-230	48Y	X241	048A11O697	✓	\$355	F1	5.4-5.4	17	5 1/2	1/2 x 6	39
1075/3		115	48Y	X009	048A11O787	✓	\$312	F1	10.2	20	5 3/4	1/2 x 4	32
1075/3		208-230	48Y	X010	048A11O2046	✓	\$317	F1	5.6	19	5 1/2	1/2 x 4	32
1075/3		277	48Y	X021	048A11O1353	✓	\$325	F1	5.0	20	5 3/4	1/2 x 4	32
1	1625/2	208-230	48Y	X211	048A17O125	✓	\$395	F1	6.2	20	6 1/4	1/2 x 2 1/2	39, 42, 43
	1075/3	230	48Y	X023	048A11O1583	✓	\$362	F1	5.3	24	6 1/2	1/2 x 5	34
	1075/3	208-230	48YZ	X242	048A11O756	✓	\$601	F1	6.2	26	7 1/4	5/8 x 4	39, 51

FAN & BLOWER - DIRECT DRIVE, PSC MOTORS

OPEN AIR OVER, RESILIENT RING MOTORS

APPLICATIONS:

Single speed PSC motors designed to replace PSC and shaded pole motors, used in direct drive furnace, air conditioners, and others blowers.



FEATURES:

- Open frame and brackets
- Heavy gauge steel frame and base
- Shaft with flat
- 70°C ambient
- 37" leads
- Thermal overload protection
- 1/4" terminals on the capacitor leads
- 2 1/4" resilient rings, includes 2 1/2" expanders
- Capacitor not included, see accessories section

HP	RPM	VOLTS	FRAME	CAT. NO.	MODEL NO.	STOCK	LIST PRICE	MULT. SYMB.	F.L. AMPS	WT.	FRAME LENGTH	SHAFT DIM.	FOOT NOTES
1/6	1625	115	48Y	X477	048A17O128	√	\$220	F1	2.6	9	4	1/2 x 4	
	1625	230	48Y	X475	048A17O123	√	\$220	F1	1.3	9	4	1/2 x 4	
	1075	115	48Y	X473	048A11O1046	√	\$212	F1	2.9	9	4	1/2 x 4	
	1075	230	48Y	X471	048A11O1044	√	\$212	F1	1.3	10	4	1/2 x 4	
1/4	1625	230	48Y	X476	048A17O124	√	\$234	F1	1.8	10	4 1/4	1/2 x 4	
	1075	115	48Y	X472	048A11O1045	√	\$222	F1	4.0	11	4 1/4	1/2 x 4	
	1075	230	48Y	X474	048A11O1047	√	\$222	F1	2.0	11	4 1/4	1/2 x 4	

FAN & BLOWER - DIRECT DRIVE, PSC MOTORS

OPEN AIR OVER, TORSION FLEX MOUNT MOTORS

APPLICATIONS:

Residential and commercial furnaces, air conditioners, exhaust fans, and other air handling equipment installed in clean and dry environments.



FEATURES:

- Open frames and brackets
- Three lug mount fits 9" or 10" bolt circle. Mounting holes on lugs are .435" dia., with gromets and sleeves for .26" dia. option.
- Multi-speed capacity
- Weather resistant reversing plug
- 30" long leads
- Automatic reset thermal protector
- Ball bearings
- UL recognized and CSA certified
- Capacitor not included, see accessories section

HP	RPM	VOLTS	FRAME	CAT. NO.	MODEL NO.	STOCK	LIST PRICE	MULT. SYMB.	F.L. AMPS	WT.	FRAME LENGTH	SHAFT DIM.	FOOT NOTES
1/4	1075/4	115	48Y	X034	048A11O1773	√	\$255	F1	3.3	14	4 1/2	1/2 x 6	
1/3	1075/4	115	48Y	X035	048A11O1774	√	\$274	F1	4.5	15	4 1/2	1/2 x 6	
1/2	1075/4	115	48Y	X036	048A11O1772	√	\$303	F1	6.0	19	5	1/2 x 6	

FAN & BLOWER - DIRECT DRIVE, PSC MOTORS

OPEN AIR OVER, EXTENDED THRU-BOLT, 460 VOLT MOTORS

APPLICATIONS:

Residential and commercial furnaces, air conditioners, exhaust fans, and other air handling equipment installed in clean and dry environments.



FEATURES:

- Enclosed frame and open end brackets
- Multi-speed capability
- Grommeted lead exit
- Weather resistant reversing plug
- Automatic reset thermal protector
- 7/8" extended thru-bolts on shaft end
- Ball bearings
- UL recognized and CSA certified
- Capacitor not included, see accessories section

HP	RPM	VOLTS	FRAME	CAT. NO.	MODEL NO.	STOCK	LIST PRICE	MULT. SYMB.	F.L. AMPS	WT.	FRAME LENGTH	SHAFT DIM.	FOOT NOTES
1/3	1075/2	460	48Y	X037	048A11O1876	√	\$477	F1	1.0	14	4 3/4	1/2 x 6	51
1/2	1075/2	460	48Y	X038	048A11O1874	√	\$486	F1	1.6	17	5 1/4	1/2 x 6	51
3/4	1075/2	460	48Y	X039	048A11O1875	√	\$496	F1	2.1	19	5 1/2	1/2 x 6	51

FAN & BLOWER - DIRECT DRIVE, PSC, OPEN AIR OVER MOTORS

BELLY BAND THRU-BOLT, DOUBLE SHAFT MOTORS

APPLICATIONS:

Continuous air over applications, such as room air conditioners, fan coil units, and other air moving applications.

FEATURES:

- Open frame and brackets
- Multi-speed capacity
- Automatic reset thermal protector
- 30" leads
- CCW rotation, fixed lead end
- 1" extended thru-bolts both ends
- 20" overall length
- Length adapter kits included where noted
- Ball bearings
- UL recognized and CSA certified
- Capacitor not included, see accessories section



HP	RPM	VOLTS	FRAME	CAT. NO.	MODEL NO.	STOCK	LIST PRICE	MULT. SYMB.	FL. AMPS	WT.	FRAME LENGTH	SHAFT DIM.	FOOT NOTES
1/8	1075/3	115	48Y	X064	048A11O2011		\$210	F1	2.4	11	4	8 1/5 x 1/2 x 7 7/8	
	1075/3	115	48Y	X056	048A11O901	√	\$233	F1	2.4	13	4	8 1/5 x 1/2 x 7 7/8	71
	1075/3	208-230	48Y	X065	048A11O2012	√	\$210	F1	1.0	11	4	8 1/5 x 1/2 x 7 7/8	
	1075/3	208-230	48Y	X057	048A11O900		\$233	F1	1.0	33	4	8 1/5 x 1/2 x 7 7/8	71
1/6	1075/3	115	48Y	X048	048A11O772		\$212	F1	3.0	14	4	8 1/5 x 1/2 x 7 7/8	
	1075/3	115	48Y	X042	048A11O653	√	\$237	F1	3.0	11	4	8 1/5 x 1/2 x 7 7/8	71
	1075/3	208-230	48Y	X049	048A11O773	√	\$212	F1	1.5	9	4	8 1/5 x 1/2 x 7 7/8	
	1075/3	208-230	48Y	X043	048A11O654	√	\$237	F1	1.5	11	4	8 1/5 x 1/2 x 7 7/8	71
1/4	1625/3	208-230	48Y	X059	048A17O2002		\$234	F1	1.8	12	4 1/4	8 x 1/2 x 7 7/8	
	1625/3	208-230	48Y	X040	048A17O69	√	\$260	F1	1.8	12	4 1/4	8 x 1/2 x 7 7/8	71
	1075/3	115	48Y	X061	048A11O2022	√	\$253	F1	4.8	14	4 1/4	8 x 1/2 x 7 7/8	71
	1075/3	115	48Y	X066	048A11O2013		\$228	F1	4.2	15	4 1/2	7 1/5 x 1/2 x 7 1/3	
	1075/3	208-230	48Y	X050	048A11O774	√	\$228	F1	2.2	13	4 1/4	8 x 1/2 x 7 7/8	
	1075/3	208-230	48Y	X044	048A11O655	√	\$253	F1	2.2	16	4 1/4	8 x 1/2 x 7 7/8	71
1/3	1625/3	208-230	48Y	X060	048A17O2003		\$252	F1	2.5	14	4 3/4	7 1/2 x 1/2 x 7 7/8	
	1625/3	208-230	48Y	X041	048A17O70	√	\$274	F1	2.5	15	4 3/4	7 1/2 x 1/2 x 7 7/8	71
	1075/3	115	48Y	X070	048A11O2024	√	\$268	F1	7.8	15	4 3/4	7 1/2 x 1/2 x 7 7/8	71
	1075/3	208-230	48Y	X052	048A11O775	√	\$242	F1	3.4	16	4 3/4	7 1/2 x 1/2 x 7 7/8	
	1075/3	208-230	48Y	X045	048A11O656	√	\$268	F1	3.4	17	4 3/4	7 1/2 x 1/2 x 7 7/8	71
	1075/3	208-230	48Y	X258	048A11O1167	√	\$234	F1	2.3	14	4 1/4	6 7/8 x 1/2 x 6 7/8	
1/2	1625/3	208-230	48Y	X058	048A17O2001	√	\$309	F1	4.1	18	5 1/4	7 x 1/2 x 7 7/8	71
	1625/3	208-230	48Y	X069	048A17O2004		\$282	F1	4.1	16	5 1/4	7 x 1/2 x 7 7/8	
	1075/3	115	48Y	X071	048A11O2026	√	\$301	F1	9.4	20	5 1/2	6 5/8 x 1/2 x 7 7/8	71
	1075/3	208-230	48Y	X062	048A11O2009	√	\$301	F1	4.7	17	5 1/2	6 5/8 x 1/2 x 7 7/8	71
	1075/3	208-230	48Y	X067	048A11O2014	√	\$276	F1	4.7	19	5 1/2	6 5/8 x 1/2 x 7 7/8	
3/4	1075/3	208-230	48Y	X068	048A11O2015		\$314	F1	5.0	15	5 3/4	6 3/4 x 1/2 x 6 7/8	
	1075/3	208-230	48Y	X063	048A11O2028	√	\$338	F1	5.4	19	5 1/2	6 5/8 x 1/2 x 7 7/8	71

FAN & BLOWER - SPLIT PHASE, DRIPPROOF MOTORS

RESILIENT BASE MOTORS (SINGLE & TWO-SPEED)

FEATURES:

- Ball bearings (except as noted)
- Service factor, as noted
- Thermal protection, as noted
- Variable torque on two speed motors
- Extended thru-bolts, as noted
- Heavy gauge steel frame and base
- 48Y and 48YZ frame have 48/56 frame mounting holes
- UL recognized and CSA certified



HP	RPM	VOLTS	FRAME	OVER LOAD	CAT. NO.	MODEL NO.	STOCK	LIST PRICE	MULT. SYMB.	FL. AMPS	WT.	"C" DIM.	FOOT NOTES
1/12	1140	115	48Z	AUTO	HG152	5KH32GN140GX	√	\$394	F1	2.4	15	9.32	8, 112
1/8	1140	115	48Z	AUTO	HG154	5KH36KN113GX	√	\$435	F1	3.8	17	10.38	8, 112
	850	115	56	AUTO	HG155	5KH46MN3021X	√	\$700	F1	4.6	32	10.88	112
1/6	1725/1140	115	48Z	NONE	H169	5KH36KN114	√	\$271	F1	3.4/1.9	17	10.38	8, 20
	1725/1140	115	48Z	AUTO	H170	5KH36KN114X	√	\$282	F1	3.4/1.9	17	10.38	8, 20
	1725/1140	115	48	NONE	4322	5KH39QN9548	√	\$325	F1	3.4/1.9	15	10.00	20
	1725/1140	115	48	AUTO	4389	5KH39QN9548X	√	\$346	F1	3.4/1.9	18	10.00	20
	1725	115	48Y	AUTO	D107	048S17D2017	√	\$241	F1	3.6	12	8.99	CF, 20
	1725	115	48	NONE	4304	5KH39QN5543	√	\$233	F1	3.9	12	8.93	20
	1725	115	48Z	NONE	HG156	5KH32DN3085	√	\$228	F1	3.9	12	9.32	8, 20
	1725	115	48YZ	NONE	B300	048S17D2052	√	\$231	F1	3.6	13	9.32	CF, 20, 31, 52
	1725	115	48Z	AUTO	H157	5KH32DN3085X	√	\$241	F1	3.9	12	9.32	8, 20
	1725	115	48YZ	AUTO	B322	048S17D2053	√	\$244	F1	3.6	13	9.32	CF, 20, 31, 52
	1725	115	56Z	AUTO	4350	5KH39QN5538X	√	\$245	F1	3.9	13	9.19	8, 20, 26
	1140	115	48	NONE	H112	5KH37PN39	√	\$386	F1	4.0	20	10.40	20
	1140	115	48Z	AUTO	H159	5KH37PN41X	√	\$478	F1	4.0	21	10.78	8, 20
	1140	115	48	NONE	HG695	5KH37PNA233	√	\$389	F1	4.0	24	10.40	20
	1140	115	48Z	NONE	H158	5KH37PN41	√	\$467	F1	4.0	21	10.78	8, 20
	1140	115	48	AUTO	HG113	5KH37PN39X	√	\$398	F1	4.0	20	10.40	20
	850	115	56	NONE	H620	5KH49PN3043	√	\$776	F1	6.1	31	11.48	20
1/4	1725/1140	115	48Y	AUTO	D180	048S17D7204		\$295	F1	4.1/2.5	18	10.06	20
	1725/1140	115	48Z	AUTO	H172	5KH37PN33X	√	\$324	F1	4.2/2.7	21	10.69	8, 20
	1725/1140	115	48Z	NONE	H171	5KH37PN33	√	\$312	F1	4.2/2.7	21	10.69	8, 20
	1725/1140	115	48	AUTO	4399	5KH39QN9551X	√	\$398	F1	4.2/2.7	22	10.40	20
	1725/1140	115	56Z	AUTO	HG704	5KH35MNA568T	√	\$406	F1	5.2/2.8	17	10.18	17, 20, 48
	1725/1140	230	48	AUTO	4412	5KH39QN9550X	√	\$448	F1	2.1/1.3	22	10.40	20, 39
	1725	115	48	AUTO	S103	048S17D2091		\$199	F1	5.7	13	9.06	3, 7, 31, 17
	1725	115	48	NONE	S102	048S17D2042	√	\$190	F1	5.7	13	9.06	3, 7, 17
	1725	115	48	NONE	H675	5KH33FNA230	√	\$314	F1	5.0	14	9.19	D, 3, 7, 17
	1725	115	48	AUTO	4305	5KH39QN5511X	√	\$207	F1	5.1	13	8.93	20
	1725	115	48	NONE	4355	5KH39QN5525	√	\$245	F1	5.1	13	8.93	20, 47
	1725	115	48Y	AUTO	4701	5KH39QN5512T	√	\$204	F1	5.1	12	9.12	CF, 20, 53
	1725	115	48YZ	AUTO	B206	048S17D2107	√	\$214	F1	5.0	14	9.62	8, 20, 26
	1725	115	48Z	NONE	H160	5KH32FN3083	√	\$244	F1	5.1	14	9.32	CF, 20, 31, 52
	1725	115	48YZ	NONE	B302	048S17D2054	√	\$249	F1	5.0	14	9.57	9, 20, 28
	1725	115	48Z	AUTO	H915	5KH33FNA722X	√	\$266	F1	5.6	14	9.99	7, 20, 26
	1725	115/230	48Y	AUTO	4702	5KH33HN5725X	√	\$258	F1	5.2/2.6	15	9.62	20, 48
	1725	115	48Y	AUTO	HG701	5KH32DN5618X	√	\$222	F1	5.1	13	8.94	9, 20
	1725	115/208-230	48Z	AUTO	4680	5KH32FN3120T	√	\$349	F1	5.0/2.5	13	9.94	8, 20
	1725	115	48Z	AUTO	HG161	5KH32FN3083X	√	\$255	F1	5.1	14	9.32	CF, 20, 31, 52
1725	115	48YZ	AUTO	B303	048S17D2055	√	\$260	F1	5.0	14	9.57	20, 32, 53	
1725	115	48Z	AUTO	S126	048S17D2104	√	\$199	F1	5.3	14	9.72	3, 53, 17	
1725	115	56Z	AUTO	4364	5KH39QN5541X	√	\$269	F1	5.7	13	9.19	3, 4, 7, 17	
1725	115	56Z	NONE	4359	5KH39QN5523	√	\$263	F1	5.7	13	9.19	3, 4, 7, 17	
1725	115	56Z	AUTO	B201	056S17D2047	√	\$214	F1	5.0	14	9.47	8, 20, 26	

Continued on next page

FAN & BLOWER - SPLIT PHASE, DRIPPROOF MOTORS

RESILIENT BASE MOTORS (SINGLE & TWO-SPEED)

HP	RPM	VOLTS	FRAME	OVER LOAD	CAT. NO.	MODEL NO.	STOCK	LIST PRICE	MULT. SYMB.	FL. AMPS	WT.	"C" DIM.	FOOT NOTES
1/4	1725	115	56Z	AUTO	4363	5KH39QN5526X	✓	\$281	F1	5.1	14	9.19	20
	1725	230	48	AUTO	4306	5KH39QN5537X	✓	\$222	F1	2.5	13	9.09	20
	1725	230	48	NONE	4360	5KH39QN5548	✓	\$271	F1	2.5	13	8.93	20, 31, 52
	1725	277	48YZ	NONE	B606	048S17D2116	✓	\$277	F1	2.1	13	9.47	20, 31
	1500	220	48	NONE	H645	5KH39QN810	✓	\$355	F1	3.4	14	9.57	3, 7, 50, 17
	1500	110/220	56Z	AUTO	HG690	5KH35JN602X	✓	\$378	F1	5.2/2.6	15	9.51	3, 7, 50, 17
	1140/850	115	56	NONE	H300	5KH49SN3048	✓	\$819	F1	5.8/3.6	30	12.01	20
	1140	115	56	AUTO	H163	5KH46MN6053X	✓	\$567	F1	5.6	23	10.88	20
	1140	115	56	NONE	H162	5KH46MN6053	✓	\$555	F1	5.6	27	10.88	19
	850	115	56	NONE	H296	5KH49SN3046	✓	\$953	F1	6.9	30	12.01	20
1/3	3450	115	48	NONE	H114	5KH35FN124	✓	\$316	F1	5.6	15	9.57	20
	3450	115	48	AUTO	HG115	5KH35FN124X	✓	\$336	F1	5.6	15	9.57	9, 20
	3450	115/230	48Z	AUTO	4798	5KH35FN153HT	✓	\$367	F1	6.8/3.4	13	10.25	9, 20
	1725/1140	115	48	AUTO	4319	5KH39QN9429T	✓	\$408	F1	6.3/3.1	22	10.40	20, 94
	1725/1140	115	48	NONE	4396	5KH39QN9683	✓	\$392	F1	6.3/3.1	21	10.40	17, 54
	1725/1140	115	48Y	AUTO	D181	048S17D7205	✓	\$367	F1	5.3/2.9	20	10.06	20
	1725/1140	115	56	NONE	H173	5KH46MN3025	✓	\$394	F1	5.7/3.2	24	10.88	20, 31
	1725/1140	115	56	AUTO	H174	5KH46MN3025X	✓	\$405	F1	5.7/3.2	32	10.88	20, 31
	1725/1140	115	56Z	AUTO	HG706	5KH37PNA569T	✓	\$465	F1	6.0/3.8	20	11.01	17, 48
	1725/850	115	56Z	AUTO	HG705	5KH46NN3039T	✓	\$708	F1	4.7/2.6	25	10.90	17, 48
	1725	115	48	NONE	4369	5KH39QN5508	✓	\$222	F1	6.2	14	8.94	3, 17
	1725	115	48	NONE	S106	048S17D2093	✓	\$225	F1	6.5	14	9.31	3, 31, CF, 17
	1725	115	48	AUTO	4310	5KH39QN5508X	✓	\$218	F1	6.2	14	8.94	3, 17
	1725	115	48Y	AUTO	S127	048S17D2105	✓	\$218	F1	6.6	14	9.72	3, 53, 17
	1725	115	48	NONE	H674	5KH35JNA231	✓	\$338	F1	6.6	15	9.57	3, 17
	1725	115	48Y	AUTO	D143	048S17D2086	✓	\$242	F1	6.1	15	9.34	20
	1725	115	48Y	AUTO	B703	048N17D14	✓	\$325	F1	3.2	17	9.84	20, 74
	1725	115	48Y	AUTO	HG711	5KH32HN5620T	✓	\$237	F1	6.6	14	8.94	4, 20, 26, 48
	1725	115	48Y	AUTO	HG700	5KHC37NNA167T	✓	\$416	F1	3.7	24	10.39	ES, 20, 26, 47
	1725	115	48YZ	AUTO	B207	048S17D2108	✓	\$242	F1	5.5	15	9.62	CF, 20, 53
	1725	115	48Z	NONE	H164	5KH32JN3128	✓	\$282	F1	6.2	15	9.32	8, 20
	1725	115	48YZ	NONE	B304	048S17D2056	✓	\$287	F1	5.5	15	9.32	CF, 20, 31, 52
	1725	115	48Z	AUTO	H917	5KH35JNA723X	✓	\$303	F1	6.9	15	10.37	9, 20, 28
	1725	115	48Z	AUTO	H165	5KH32JN3128X	✓	\$292	F1	6.2	16	9.32	8, 20
	1725	115	48YZ	AUTO	B305	048S17D2057	✓	\$296	F1	5.5	15	9.32	CF, 20, 31, 52
	1725	115	56Z	NONE	4377	5KH39QN5524	✓	\$287	F1	6.2	15	9.19	3, 7, 17
	1725	115	56Z	AUTO	4381	5KH39QN5528X	✓	\$293	F1	6.2	15	9.19	3, 7, 17
	1725	115	56Z	AUTO	4776	5KH39QN5539T	✓	\$293	F1	6.2	16	9.19	D, 3, 7, 57, 17
	1725	115	56Z	AUTO	B202	056S17D2048	✓	\$249	F1	6.1	15	9.72	20, 32, 53
	1725	230	48Z	AUTO	H167	5KH35JN26X	✓	\$255	F1	3.3	16	9.95	8, 20
	1725	230	48	NONE	4371	5KH39QN5529	✓	\$287	F1	3.3	14	8.94	3, 17
	1725	230	48	AUTO	4311	5KH39QN5529X	✓	\$293	F1	3.3	14	8.93	3, 17
	1725	230	48	AUTO	4309	5KH39QN9514X	✓	\$370	F1	3.1	15	9.18	20
	1725	115	48	NONE	4370	5KH39QN9682	✓	\$339	F1	6.2	15	9.18	20
	1725	115/208-230	56Z	AUTO	4682	5KH35JN3132T	✓	\$392	F1	6.2/3.1	16	10.26	9, 20, 26, 72
	1725	230	48Z	NONE	H166	5KH35JN26	✓	\$375	F1	3.3	16	9.95	8, 20
	1725	230	56Z	AUTO	4757	5KH39QN9636T	✓	\$387	F1	3.1	16	9.19	7, 20, 26
	1725	277	48YZ	NONE	B607	048S17D2117	✓	\$312	F1	2.5	15	9.72	20, 31, 52
	1725	115	56Z	AUTO	4383	5KH39QN9513X	✓	\$363	F1	6.2	15	9.19	8, 26
	1500	110/220	56Z	AUTO	HG692	5KH36LN489X	✓	\$405	F1	7.0/3.5	17	9.94	3, 50, 17
1500	220	56Z	NONE	H673	5KH33KN5594	✓	\$386	F1	3.5	17	9.19	3, 7, 50, 17	
1140	115/230	56	NONE	H168	5KH49PN6055	✓	\$644	F1	7.0/3.5	27	11.48	20	
1140	115/230	56	AUTO	HG621	5KH49PN6055X	✓	\$668	F1	7.0/3.5	26	11.48	20	

Continued on next page

FAN & BLOWER - SPLIT PHASE, DRIPPROOF MOTORS

RESILIENT BASE MOTORS (SINGLE & TWO-SPEED)

HP	RPM	VOLTS	FRAME	OVER LOAD	CAT. NO.	MODEL NO.	STOCK	LIST PRICE	MULT. SYMB.	FL. AMPS	WT.	"C" DIM.	FOOT NOTES	
1/2	1725/1140	115	56	NONE	H175	5KH49PN3026	√	\$497	F1	8.0/4.2	31	11.48	19, 31	
	1725/1140	115	56	AUTO	H176	5KH49PN3026X	√	\$508	F1	8.0/4.2	31	11.48	19, 31	
	1725/1140	115	56	NONE	H130	5KH39QN9632	√	\$558	F1	8.4/4.8	22	10.32	17	
	1725/1140	115	56	AUTO	H131	5KH39QN9631T	√	\$577	F1	8.4/4.8	22	10.32	17, 31	
	1725/1140	115	56Z	AUTO	HG715	5KH38SNA731T	√	\$657	F1	7.8/4.8	25	11.44	17, 48	
	1725/1140	230	56	NONE	H275	5KH49PN3045	√	\$695	F1	3.8/1.9	28	11.48	19, 31	
	1725/1140	230	56	AUTO	H133	5KH39QN9642T	√	\$602	F1	4.1/2.4	22	10.32	17, 31	
	1725	115	48Y	AUTO	D162	048S17D2087	√	\$330	F1	7.2	19	10.09	19	
	1725	115	48Y	AUTO	HG703	5KH36MNA519T	√	\$319	F1	7.9	15	10.32	19, 48	
	1725	115	48Z	AUTO	HG710	5KH33JNA511T	√	\$265	F1	7.9	15	9.93	3, 9, 17	
	1725	115	48Z	AUTO	S128	048S17D2106	√	\$265	F1	9.2	17	10.22	3, 53, 17	
	1725	115	48YZ	AUTO	B208	048S17D2109	√	\$330	F1	7.5	20	10.43	CF, 19, 53	
	1725	115	48YZ	NONE	B306	048S17D2058	√	\$347	F1	7.5	18	10.32	CF, 19, 31, 52	
	1725	115	48	AUTO	HG694	5KH39QN9767X	√	\$368	F1	7.1	19	9.99	19	
	1725	115	48YZ	AUTO	B307	048S17D2059	√	\$378	F1	7.5	18	10.32	CF, 19, 31, 52	
	1725	115	56Z	AUTO	H919	5KH36MNA735X	√	\$373	F1	8.7	18	10.80	10, 19, 28	
	1725	115	56	AUTO	4392	5KH39QN9405X	√	\$367	F1	7.9	21	10.32	19	
	1725	115	56	NONE	4390	5KH39QNA039	√	\$411	F1	7.9	17	10.32	19	
	1725	115	56	AUTO	D149	056S17D2050	√	\$338	F1	7.2	19	10.47	19	
	1725	115	56	AUTO	H248	5KH36MN3106X	√	\$418	F1	9.3	18	10.32	19	
	1725	115	56	NONE	H286	5KH36MN3106	√	\$411	F1	9.3	18	10.32	19	
	1725	115	56	NONE	S120	056S17D2023	√	\$261	F1	9.2	18	10.22	3, 31, 17	
	1725	115	56Z	AUTO	4778	5KH39QN9639T	√	\$405	F1	8.3	20	9.57	3, 7, 17	
	1725	115	56Z	AUTO	B200	056S17D2049	√	\$338	F1	7.2	19	10.47	19, 32, 53	
	1725	115	56Z	AUTO	4758	5KH39QN9698T	√	\$429	F1	7.9	22	9.99	7, 19, 26	
	1725	115/230	56	AUTO	B100	056S17D2064	√	\$355	F1	7.2/3.6	20	10.47	19	
	1725	115/230	56Z	AUTO	4684	5KH36MN3127T	√	\$485	F1	8.9/4.5	18	10.69	9, 26	
	1725	230	56	AUTO	4602	5KH39QN9518X	√	\$438	F1	4.2	19	10.32	3, 17	
	1725	230	56	NONE	4387	5KH39QN9684	√	\$426	F1	4.2	19	10.32	3, 17	
	1725	230	56	AUTO	4393	5KH39QN9544X	√	\$448	F1	4.5	21	10.32	19	
	1725	230	56Z	AUTO	4759	5KH39QN9697T	√	\$346	F1	4.0	17	9.99	19	
	1725	230	48Y	AUTO	D163	048S17D2088	√	\$346	F1	3.6	19	10.09	19	
	1500	110/220	56	AUTO	H693	5KH46JN0329X	√	\$451	F1	9.2/4.6	23	10.55	3, 17	
	1140	115/230	56	AUTO	H298	5KH48UN6054X	√	\$854	F1	9.0/4.5	32	12.76	19	
	3/4	1725	115	56	NONE	4422	5KH39QN9687	√	\$500	F1	11.2	21	10.72	3, 17
		1725	115	56	AUTO	4338	5KH39QN9541T	√	\$438	F1	11.4	21	10.72	18

HVAC / AIR MOVING

FAN & BLOWER - SPLIT PHASE MOTORS

RESILIENT BASE MOTORS (SINGLE & TWO-SPEED)

FEATURES:

- Ball bearings (except as noted)
- Service factor, as noted
- Open construction (except as noted)
- Extended thru-bolts, as noted
- Continuous duty



HP	RPM	VOLTS	FRAME	OVER LOAD	CAT. NO.	MODEL NO.	STOCK	LIST PRICE	MULT. SYMB.	F.L. AMPS	WT.	"C" DIM.	FOOT NOTES
1/12	1140	115	48Z	Auto	BF20086V1	Century®	√	\$407	F1	2.69	17	9.5	112, 144
1/8	1140	115	48	Auto	BF2006L	Century	√	\$435	F1	3.3	16	10.2	112, 144
	850	115	56	Auto	BF2008	Century	√	\$741	F1	4.4	23	11.1	32, 112, 144
1/6~1/18	1725/1140	115	48Z	Auto	BGF2014L	Century	√	\$486	F1	4.4/2.1	16	10.7	20, 32, 131, 144
1/6	1725	115	48	Auto	GF2014	Century	√	\$279	F1	5.1	11	8.9	4, 20, 103
	1725	115	48	None	RS2014L	Century	√	\$294	F1	4.3	10	8.9	4, 20
	1725	115	48Z	None	917L	Century	√	\$388	F1	4.1	14	9.7	4, 20, 102
	1725	115	48Z	Auto	RB2014	Century	√	\$296	F1	5.1	11	9.3	4, 20, 131
	1725	115	56Z	Auto	RS2014	Century	√	\$245	F1	5.1	13	9.6	4, 20, 53
	1140	115	48	Auto	815A	Century	√	\$519	F1	3.8	17	9.9	4, 20, 144
1/4~.07	1140	115	48	None	815V2	Century	√	\$521	F1	3.6	18	10.2	20, 144
	1725	115	48Z	Auto	927L	Century	√	\$558	F1	4.4/2.2	19	10.7	20, 102, 144
1/4~1/12	1725	115	48Z	None	924L	Century	√	\$537	F1	3.7/2.1	19	10.7	102, 144
	1725/1140	230	48	Auto	927AL	Century	√	\$592	F1	2.7/1.3	17	9.8	20, 144
1/4	1725	115	48	None	GF2020L	Century	√	\$262	F1	5.5	12	8.9	4
	1725	115	48	Auto	GF2024	Century	√	\$214	F1	5.4	13	9.2	4, 20, 103, 144
	1725	115	48Z	Auto	920L	Century	√	\$436	F1	4.6	14	9.7	20, 102, 144
	1725	115	48Z	None	919L	Century	√	\$418	F1	5.1	13	9.6	20, 102, 144
	1725	115	48	Auto	RB2024	Century	√	\$376	F1	5.0	14	9.4	20, 68
	1725	115	56Z	Auto	RS2026	Century	√	\$326	F1	5.4	12	9.2	4, 20, 53
	1725	115/208-230	48	Auto	GF2024D	Century	√	\$392	F1	5.2/2.6	14	9.2	4, 20, 103
	1725	115/208-230	48	Auto	BF2024	Century	√	\$369	F1	5.2/2.6	14	9.2	4, 20, 94, 103
	1140	115	56	None	RB2026L	Century	√	\$642	F1	5.7	23	10.8	4, 20
	1140	115	56	None	F340	Century	√	\$642	F1	5.0	24	11.1	4, 20
	1140	115	56	Auto	RB2026	Century	√	\$651	F1	5.6	23	10.8	4, 20, 31
1/3~1/11	1725/1140	115	48	Auto	925AL	Century	√	\$579	F1	6.6/2.4	18	10.3	4, 20, 32
	1725/1140	115	56	Auto	F390	Century	√	\$559	F1	5.0/3.0	24	11.1	4, 20, 32
	1725/1140	115	48Z	None	925L	Century	√	\$582	F1	4.9/2.5	20	10.8	4, 20, 102
1/3~1/10	1725/1140	115	56Z	Auto	SGF2034V4	Century	√	\$414	F1	6.7/3.3	20	10.0	4, 20, 128
1/3	3450	230/115	48Z	Auto	F344V1	Century	√	\$402	F1	3.2/6.3	17	10.3	9, 20, 31, 144
	1725	115	56Z	Auto	807L	Century	√	\$484	F1	5.7	16	7.3	4, 128, 144
	1725	115	48Z	None	921L	Century	√	\$454	F1	5.7	14	10.2	20, 127, 144
	1725	115	56Z	None	GF2031L	Century	√	\$330	F1	6.2	12	9.4	4, 130
	1725	115	48	Auto	GF2034	Century	√	\$242	F1	6.8	15	9.4	4, 20, 103
	1725	230	48/56	Auto	GF2038	Century	√	\$358	F1	3.7	14	9.4	4, 20, 72, 103
	1725	115/230	48/56	Auto	GF2034D	Century	√	\$435	F1	6.4/3.2	15	8.9	4, 20, 72, 103
	1725	115/230	48/56	Auto	BF2034	Century	√	\$394	F1	6.4/3.2	15	9.4	4, 20, 72, 94, 103
	1725	115	48	Auto	RB2034	Century	√	\$403	F1	6.0	14	9.4	4, 20
	1725	115	48	None	RB2034L	Century	√	\$408	F1	6.6	15	9.4	4, 20, 68
	1725	115	48Z	Auto	922L	Century	√	\$471	F1	6.0	14	10.2	4, 20, 102
	1725	115/208-230	56Z	Auto	BF2034B	Century	√	\$392	F1	6.6/3.2-3.3	16	10.1	4, 20, 53, 92
	1425	220	48	Auto	GF2035	Century	√	\$414	F1	3.2	15	9.4	4, 20, 50
	1140	115/230	56	Auto	RB2036	Century	√	\$668	F1	6.2/3.1	28	11.1	20, 32, 144
	1/2~.14	1725/1140	115	56	None	F387	Century	√	\$681	F1	6.8/3.0	26	11.1

FAN & BLOWER - SPLIT PHASE MOTORS

RESILIENT BASE MOTORS (SINGLE & TWO-SPEED)

FEATURES:

- Ball bearings (except as noted)
- Service factor, as noted
- Open construction (except as noted)
- Extended thru-bolts, as noted
- Continuous duty



HP	RPM	VOLTS	FRAME	OVER LOAD	CAT. NO.	MODEL NO.	STOCK	LIST PRICE	MULT. SYMB.	FL. AMPS	WT.	"C" DIM.	FOOT NOTES
1/2~.14	1725/1140	115	56	Auto	F391	Century®	√	\$693	F1	6.8/3.8	32	11.4	19, 32, 144
1/2~1/6	1725/1140	115	56Z	Auto	SGF2054AV2	Century	√	\$508	F1	9.9-4.4	21	10.0	4, 20, 128
	1725/1140	230	56	Auto	SGF2054HL	Century	√	\$456	F1	5.3/2.4	31	10.4	4, 94
1/2~1/4	1725/1140	115	56	Auto	SGK2054V1	Century	√	\$666	F1	9.0/6.4	24	10.8	4, 18, 128
1/2	1725	115	48	Auto	GF2054	Century	√	\$330	F1	8.0	18	9.9	4, 19, 103, 144
	1725	115	56	Auto	GK2054	Century	√	\$467	F1	8.1	17	10.3	4, 19
	1725	115/208-230	48/56	Auto	GF2054D	Century	√	\$524	F1	8.2/4.1	17	9.9	4, 19, 103
	1725	115/208-230	48/56	Auto	BF2054	Century	√	\$506	F1	8.2/4.1	18	9.9	19, 94, 103
	1725	115/230	56	Auto	RB2054DV2	Century	√	\$526	F1	9.6/4.8	20	10.3	19
	1725	115/230	56Z	Auto	RB2054DV3	Century	√	\$498	F1	9.6/4.8	19	10.3	19
	1725	115/208-230	48Z	Auto	BF2054V1	Century	√	\$506	F1	8.2/4.1	16	10.7	9, 19, 32, 53
	1140	115/230	56	Auto	BF2056D	Century	√	\$854	F1	9.2/4.6	30	11.4	19, 32, 144
3/4	1725	115	56	Auto	GK2074	Century	√	\$655	F1	12.2	21	10.8	4, 19
	1725/1425	230/115	56	Auto	F681	Century	√	\$627	F1	5.2/10.4/6.4/12.8	31	11.4	4, 19, 68, 144
	1725/1425	230/115	56	Auto	F680	Century	√	\$633	F1	5.2/10.4	29	11.4	19, 68, 144
1	1725	115/230	56	Auto	GK2104DV1	Century	√	\$838	F1	15.5/7.7	25	12.3	4, 19, 68

FAN & BLOWER - SPLIT PHASE MOTORS

RIGID BASE MOTORS

FEATURES:

- Ball bearings (except as noted)
- Service factor, as noted
- Open construction (except as noted)
- Extended thru-bolts, as noted
- Continuous duty



HP	RPM	VOLTS	FRAME	OVER LOAD	CAT. NO.	MODEL NO.	STOCK	LIST PRICE	MULT. SYMB.	FL. AMPS	WT.	"C" DIM.	FOOT NOTES
1/4	1725	115	48	None	902L	Century	√	\$379	F1	3.1	21	10.3	N
	1725	115	48	None	OB2024L	Century	√	\$347	F1	5.4	12	9.2	20
	1725	115	48Z	Auto	OB2024	Century	√	\$344	F1	5.4	11	10.0	9, 17, 31
	1725	115	56	None	F661	Century	√	\$508	F1	3.8	25	11.1	N, AI
1/3	1725	115	56Z	None	OS2031L	Century	√	\$289	F1	6.2	14	9.4	4, 129, 144
	1725	115	48	Auto	889A	Century	√	\$460	F1	6.1	14	9.4	20
	1725	115	48Z	Auto	889V2	Century	√	\$455	F1	5.3	16	10.1	9, 17, 32, 144
1/2	1725	115	56Z	Auto	OS2050	Century	√	\$367	F1	8.1	18	10.6	32, 17, 120
3/4	1725	115	56Z	Auto	OS2074	Century	√	\$438	F1	9.6	20	11.1	32, 120

FAN & BLOWER - CAPACITOR START, DRIPPROOF MOTORS

RESILIENT BASE MOTORS (SINGLE & TWO-SPEED)

FEATURES:

- Ball bearings, except as noted
- Heavy gauge steel frame and base
- Service factor, as noted
- Capacitor start / capacitor run as noted
- Thermal protection, as noted
- 48Y and 48YZ frame have 48/56 frame mounting holes
- UL recognized and CSA certified



HP	RPM	VOLTS	FRAME	OVER LOAD	CAT. NO.	MODEL NO.	STOCK	LIST PRICE	MULT. SYMB.	F.L. AMPS	WT.	"C" DIM.	FOOT NOTES
1/4	1725	115	48	AUTO	CG201	5KC35JN12X	✓	\$355	F1	5.2	16	9.57	D, 4, 20
	1725	115	48	NONE	C200	5KC35JN12	✓	\$347	F1	5.2	16	9.57	D, 20
	1725	115/230	48	AUTO	S119	048C17D2046	✓	\$276	F1	6.2/3.1	13	9.06	7, 17
	1725	115/230	48	NONE	S118	048C17D2045	✓	\$261	F1	6.2/3.1	14	9.06	7, 17
	1725	115/230	48	NONE	G1114	5KC35JN7J	✓	\$276	F1	5.2/2.6	16	9.57	20
	1725	115/208-230	48YZ	AUTO	B313	048C17D2042	✓	\$324	F1	5.2/2.8-2.6	16	9.95	CF, 20, 31, 52
	1725	115/208-230	48YZ	NONE	B312	048C17D2041	✓	\$309	F1	6.2/2.8-3.1	15	9.72	20, 31, 52
	1725	115/230	48	AUTO	G1115	5KC35JN7JX	✓	\$292	F1	5.2/2.6	16	9.57	20
	1500	110/220	48	AUTO	C460	5KC36LN19X	✓	\$448	F1	5.6/2.8	18	10.00	20, 50
	1/3	3450	115/230	48	AUTO	C208	5KC35FN51X	✓	\$378	F1	6.8/3.4	15	9.57
1725	100-120/200-240	56	AUTO	E254	5KCR46JN0086X	✓	\$537	F1	4.0-3.8/2.0-1.9	25	10.77	ES, 1, 20, 68	
1725	115/208-230	48	NONE	C209	5KC36LN26	✓	\$429	F1	6.0/3.2-3.0	18	10.00	20, 68	
1725	115/208-230	48	AUTO	C210	5KC36LN26X	✓	\$453	F1	6.0/3.2-3.0	18	10.00	20, 68	
1725	115/208-230	56	NONE	C215	5KC36LN1	✓	\$384	F1	6.0/3.2-3.0	18	10.32	20, 68	
1725	115/208-230	48YZ	NONE	B314	048C17D2043	✓	\$365	F1	5.8/3.1-2.9	18	10.22	20, 31, 52	
1725	115/208-230	48YZ	AUTO	B315	048C17D2044	✓	\$378	F1	5.8/3.1-2.9	17	10.22	20, 31, 52	
1725	115/208-230	56	AUTO	C216	5KC36LN1X	✓	\$465	F1	6.0/3.2-3.0	18	10.32	20, 50	
1725	115/208-230	56	AUTO	B210	56C17D2100	✓	\$359	F1	5.8/3.1-2.9	18	10.22	19	
1725	115/230	48	AUTO	C129	5KC35JN23X	✓	\$292	F1	6.4/3.2	16	9.57	17	
1725	115/230	48	AUTO	S111	048C17D2029	✓	\$292	F1	7.0/3.5	16	9.31	17	
1725	115/230	48	NONE	S110	048C17D2028	✓	\$276	F1	7.0/3.5	16	9.31	17	
1725	115/230	48YZ	AUTO	D119	048C17D2055	✓	\$347	F1	5.8/2.9	12	10.22	20, 31, 52	
1725	115/230	56	AUTO	G135	056C17D2088	✓	\$352	F1	6.4/3.2	18	10.22	20	
1500	110/220	56	AUTO	C457	5KC37NN14T	✓	\$543	F1	7.4/3.7	20	10.72	20, 50	
1140	115/230	56	NONE	C1258	5KC49PN6051	✓	\$631	F1	8.6/4.3	28	11.38	20	
1140	115/230	56	AUTO	C548	5KC49PN6051X	✓	\$649	F1	8.6/4.3	28	11.38	20	
1/2	3450	115/208-230	48	AUTO	C1152	5KC39QN3220X	✓	\$279	F1	8.2/3.9-4.1	19	11.00	19
	1725/1140	115	56	AUTO	C419	5KC49PN3027X	✓	\$795	F1	8.2/3.9	28	11.38	19
	1725	100-120/200-240	56	AUTO	E263	5KCR46MN0054X	✓	\$642	F1	5.8-5.6/2.9-2.8	27	10.77	ES, 1, 19, 68
	1725	115/208-230	56	NONE	B1316	5KC49GN0001	✓	\$413	F1	8.8/4.2-4.4	21	10.38	19
	1725	115/208-230	56	AUTO	C1153	5KC49GN0022X	✓	\$467	F1	8.6/4.1-4.3	21	10.38	19
	1725	115/208-230	56	AUTO	B317	056C17D2072	✓	\$477	F1	8.0/4.1-4.0	20	10.32	CF, 19, 31
	1725	115/208-230	56Y	AUTO	B353	056B17D67	✓	\$510	F1	6.2/3-3.1	24	12.92	1, 19, 55
	1725	115/230	56Z	AUTO	S113	056C17D2099	✓	\$352	F1	9.1/4.5	19	10.22	17
	1725	115/230	56	NONE	S112	056C17D2097	✓	\$339	F1	9.1/4.5	19	10.22	17
	1725	115/230	48	AUTO	C133	5KC36MN27X	✓	\$491	F1	8.2/4.1	19	10.00	17
	1725	115/230	56	AUTO	CG223	5KC49GN0001X	✓	\$500	F1	8.8/4.4	21	10.38	19
	1725	115/230	56	AUTO	D111	056C17D2079	✓	\$419	F1	7.2/3.6	20	10.72	19
	1725	115/230	56	AUTO	G151	056C17D2025	✓	\$419	F1	8.6/4.3	24	11.72	19
	1725	277	56	NONE	B608	056C17D2113	✓	\$472	F1	3.6	23	11.72	19
	1140	115/230	56	NONE	C1264	5KC48UN6052	✓	\$899	F1	9.4/4.7	40	12.76	19
	1140	115/230	56	AUTO	C552	5KC48UN6052X	✓	\$918	F1	9.4/4.7	36	12.76	19

Continued on next page

FAN & BLOWER - CAPACITOR START, DRIPPROOF MOTORS

RESILIENT BASE MOTORS (SINGLE & TWO-SPEED)

HVAC / AIR MOVING

HP	RPM	VOLTS	FRAME	OVER LOAD	CAT. NO.	MODEL NO.	STOCK	LIST PRICE	MULT. SYMB.	FL. AMPS	WT.	"C" DIM.	FOOT NOTES
3/4	3450	115/208-230	56	AUTO	C1155	5KC38NN410X	√	\$363	F1	10.0/4.9-5.0	17	11.32	19
	3450	115/208-230	48	AUTO	C1154	5KC38NN413X	√	\$513	F1	9.8/5.0-4.9	17	11.0	19
	1725/1140	115	56	AUTO	B332	056B17D5701		\$754	F1	8.9/6.1	40	12.85	1, 19, 31
	1725/1140	115	56	NONE	C420	5KCR49PN3011	√	\$738	F1	9.0/6.4	31	11.48	ES, 1, 19
	1725/1140	208-230	56	NONE	C486	5KCR49PN3012X	√	\$752	F1	4.3-4.4/3.1-3.2	38	11.48	ES, 1, 19
	1725/1140	115	56	AUTO	C474	5KCR49PN3011X		\$869	F1	9.0/6.4	31	11.48	ES, 1, 19
	1725	100-120/200-240	56	AUTO	EG272	5KCR49PN0098X	√	\$798	F1	9.0-8.8/4.5-4.4	31	11.37	ES,1,17,68
	1725	115/208-230	56	AUTO	C138	5KC46JN0002X	√	\$561	F1	11.4/5.6-5.7	23	10.78	19
	1725	115/208-230	56	AUTO	C1156	5KC46LN0149X	√	\$563	F1	13.3/6.5-6.6	27	10.78	19
	1725	115/208-230	56	AUTO	B319	056C17D2074	√	\$579	F1	10.0/5.2-5.0	23	10.72	CF, 19, 31
	1725	115/208-230	56	NONE	CG230	5KC46LN0158	√	\$520	F1	13.2/6.2-6.6	25	10.78	19
	1725	115/208-230	56	NONE	B318	056C17D2073	√	\$537	F1	10.0/5.2-5.0	24	10.72	CF, 19, 31
	1725	115/208-230	56	NONE	G156	056B17D2012	√	\$516	F1	11.0/5.5-5.5	26	11.47	1, 19
	1725	115/208-230	56Z	AUTO	4686	5KC46LN0269X	√	\$614	F1	13.3/6.5-6.6	25	11.15	10, 19
	1725	115/230	56	NONE	S114	056C17D2060	√	\$403	F1	10.4/5.2	25	11.97	17
	1725	115/230	56	AUTO	C1483	5KC46LN0254X	√	\$419	F1	13.2/6.6	25	10.78	17
	1725	115/230	56	AUTO	S115	056C17D2061	√	\$419	F1	10.4/5.2	25	11.97	17
	1725	115/230	56	AUTO	D1113	5KC46LN0158X	√	\$518	F1	13.2/6.6	25	10.78	19
	1725	277	56	NONE	B609	056B17D2013	√	\$574	F1	4.3	27	11.47	1, 19, 31
	1500	110/220	56	AUTO	C1187	5KC49NN0224X	√	\$738	F1	12.2/6.1	28	11.38	19, 50
1140	115/230	56	NONE	CG232	5KCR49WN6077	√	\$1,039	F1	12.6/6.3	42	13.96	1, 18	
1	3450	115/208-230	56	AUTO	C1157	5KC39RN383X	√	\$453	F1	13.4/6.7-6.6	25	11.85	19
	3450	115/208-230	56	AUTO	D118	056C34D2106	√	\$424	F1	12.0/6.2-6.0	25	12.22	18
	1725/1140	115	56	AUTO	B335	056B17D5703	√	\$939	F1	11.5/7.0	39	12.85	1, 18, 31
	1725/1140	115	56	NONE	C475	5KCR49SN3009	√	\$921	F1	10.8/7.4	35	12.01	ES, 1, 18
	1725/1140	115	56	AUTO	C1478	5KCR49SN3009X		\$958	F1	10.8/7.4	30	12.01	ES, 1, 18
	1725/1140	208-230	56	NONE	C476	5KCR49SN3010		\$958	F1	5.3-5.4/3.6-3.7	35	12.01	ES, 1, 18
	1725/1140	208-230/190-380	56H	AUTO	C1479	5KCR48TN3084X	√	\$977	F1	5.3-5.4/3.6-3.7	36	12.54	ES, 1, 17
	1725	100-120/200-240	56H	AUTO	E281	5KCR48UN0105X	√	\$838	F1	11.8-11.4/5.9-5.7	40	12.65	ES, 1, 18, 68
	1725	115/208-230	56	AUTO	C1158	5KC49PN0164X	√	\$588	F1	14.7/7.2-7.4	29	11.38	18
	1725	115/208-230	56Z	AUTO	4688	5KC49NN0061T	√	\$596	F1	14.4/7.2-7.4	28	11.75	10, 18
	1725	115/208-230	56	NONE	C235	5KC49PN0155	√	\$548	F1	13.6/6.7-6.8	31	11.38	18
	1725	115/230	56	AUTO	S117	056C17D5340	√	\$555	F1	13.6/6.8	28	11.35	17
	1725	115/230	56	NONE	S116	056C17D5339	√	\$540	F1	13.6/6.8	29	11.35	17
	1725	115/230	56	AUTO	CG236	5KC49PN0155X		\$666	F1	13.6/6.8	30	11.38	18
	1725	277	56	NONE	B337	056C17D5348	√	\$615	F1	5.6	29	11.85	19, 32
	1 1/2	3450	115/208-230	56H	AUTO	D115	056B34D2027	√	\$590	F1	13.4/7.4-6.7	28	11.72
3450		115/208-230	56H	AUTO	C1159	5KC49RN2152T		\$590	F1	19.6/9.8-9.8	33	12.01	18
1725		115/208-230	145T	NONE	I146	145TCDR5331	√	\$668	S1	18.0/9.3-9.0	42	13.22	18, 32
1725		115/208-230	56H	NONE	B336	056C17D5347	√	\$658	F1	18.0/9.3-9.0	39	12.85	5, 18, 32
1725		115/208-230	56H	AUTO	CG239	5KCR49SN0012X	√	\$783	F1	18.2/9.1	35	11.91	ES, 1, 5, 18
1725		115/208-230	56H	AUTO	C1160	5KCR49SN0150X	√	\$684	F1	16.4/8.4-8.2	35	11.91	ES, 1, 18
1725		277	56H	NONE	B338	056C17D5349	√	\$712	F1	7.5	41	12.85	5, 18, 32
2	3450	115/208-230	56H	AUTO	C1161	5KCR49RN2148T	√	\$719	F1	19.6/10.4-9.8	33	11.91	ES, 1, 110
	3450	115/208-230	56H	AUTO	K152	056B34D5320	√	\$717	F1	19.2/10.5-9.6	33	11.85	1, 5, 18
	1725	115/208-230	56H	AUTO	B352	056B17D5331	√	\$872	F1	21.0/11.3-10.5	50	13.85	1, 5, 32
	1725	115/208-230	145T	NONE	I147	145TBDR5345	√	\$701	S1	21/11.3-10.5	49	14.22	1, 18

FAN & BLOWER - CAPACITOR START MOTORS

RESILIENT BASE MOTORS (SINGLE & TWO-SPEED)

FEATURES:

- Open dripproof except as noted
- Service factor, as noted
- 40° C ambient
- Extended thru-bolts, as noted
- Capacitor start / capacitor run as noted
- Ball bearings (except as noted)



HP	RPM	VOLTS	FRAME	OVER LOAD	CAT. NO.	MODEL NO.	STOCK	LIST PRICE	MULT. SYMB.	FL. AMPS	WT.	"C" DIM.	FOOT NOTES
1/4	1725	115/230	48	Auto	RS1024A	Century®	√	\$389	F1	5.6/2.8	15	9.4	4, 20, 57
	1725	115/230	48	Auto	C196L	Century	√	\$496	F1	5.0/2.5	15	9.3	20
1/3	3450	115/208-230	48	Auto	B171	Century	√	\$404	F1	6.2/3.4-3.1	18	9.9	19
	1725	115/230	48	Auto	RBF1034A	Century	√	\$528	F1	6.4/3.2	18	9.4	20, 57, 68
	1725	115/230	48	None	C105L	Century	√	\$519	F1	7.70/3.85	15	9.8	20
	1725	115/230	48	Auto	RS1030B	Century	√	\$453	F1	7.0/3.5	15	9.4	4, 17, 57
	1725	115/230	48	Auto	RS1035A	Century	√	\$453	F1	6.2/3.1	17	9.9	4, 20
	1725	115/230	48Z	Auto	RS1034A	Century	√	\$432	F1	6.4/3.2	18	9.8	4, 20, 57, 68, 109
	1725/1425	115/230	56	Auto	C309	Century	√	\$615	F1	5.2/2.6//6.6/3.3	24	11.1	20, 68
	1725	115/208-230	56	Auto	C403V1	Century	√	\$487	F1	6.6/3.0-3.3	22	11.1	20
	1725	115/208-230	56	Auto	C455	Century	√	\$470	F1	6.6/3.0-3.3	22	11.1	4, 20
	1725	115/208-230	56	None	C226	Century	√	\$510	F1	6.6/3.0-3.3	22	11.1	20, 57
1/2~1/4	1725/1140	115	56	Auto	C678V1	Century	√	\$961	F1	6.8/4.8	30	11.4	4, 17
1/2	3450	115/208-230	56	Auto	RB1052L	Century	√	\$411	F1	8.0/3.8-4.0	19	10.4	19
	3450	115/208-230	48Z	Auto	BF1052V1	Century	√	\$483	F1	9.4/4.7-4.7	18	11.3	9, 92, 114, 66, Q
	3450	115/208-230	48Y	Auto	B590	Century	√	\$410	F1	8.0/3.8-4.0	20	9.9	19, 117
	3450	115/208-230	56	Auto	BK1052	Century	√	\$491	F1	9.4/4.7	18	10.9	114, 66, Q
	1725	115/230	48	Auto	RS1050A	Century	√	\$491	F1	8.6/4.3	17	10.3	4, 17, 57
	1725	115/230	56	Auto	RS1051A	Century	√	\$496	F1	8.6/4.3	17	10.3	4, 17, 57
	1725/1425	115/230	56	Auto	RB1054AV1	Century	√	\$544	F1	9.6/4.8	22	11.3	19, 68
	1725/1425	115/230	56	Auto	RS1054AV1	Century	√	\$514	F1	9.6/4.8	26	11.3	4, 19, 57, 68
	1725	115/208-230	56	Auto	C607	Century	√	\$514	F1	9.0/4.0-4.5	24	11.1	4, 19
	1725	115/208-230	56	None	C634	Century	√	\$511	F1	9.0/4.0-4.5	26	11.1	4, 19
3/4~.21	1725/1140	115	56	Auto	C412V1	Century	√	\$541	F1	9.0/4.0-4.5	26	11.1	19, 92
3/4~.21	1725/1140	115	56	None	C435	Century	√	\$1088	F1	9.2/4.6	30	11.4	17, 32
	1725/1140	208-230	56	None	C448	Century	√	\$1112	F1	5.0-4.6/2.5-2.3	29	11.4	17, 31
3/4~1/3	1725/1140	115	56	Auto	C741V1	Century	√	\$1,248	F1	10.0/6.4	34	12.2	4, 17
	1725/1140	230	56	Auto	C742V1	Century	√	\$1,274	F1	5.0/3.2	34	12.2	4, 17
3/4	3450	115/208-230	48	Auto	BF1072	Century	√	\$528	F1	12.8/6.4	20	11.1	113, 66, Q
	3450	115/208-230	56	Auto	BK1072	Century	√	\$528	F1	12.8/6.4	21	11.4	113, 66, Q
	3450	208-230/115	56	Auto	B588	Century	√	\$529	F1	4.7-4.6/9.2	27	11.1	19
	1725	115/208-230	56	Auto	RB1074A	Century	√	\$633	F1	13.0/6.5	22	10.8	19
	1725	115/230	56	Auto	RS1074AL	Century	√	\$603	F1	12.0/6.0	31	11.8	4, 19, 57, 68
	1725	115/208-230	56	Auto	RS1070AV1	Century	√	\$589	F1	10.6/5.3	22	10.8	4, 17
	1725	208-230/115	56	None	C666	Century	√	\$624	F1	5.4-5.5/11.0	28	11.1	19
	1725	208-230/115	56	Auto	C426V1	Century	√	\$630	F1	5.4-5.5/11.0	34	11.1	19, 92
	1725	208-230/115	56	Auto	C654	Century	√	\$603	F1	5.4-5.5/11.0	26	11.1	4, 19
	1725/1425	230/115	56	Auto	C527	Century	√	\$856	F1	4.3/8.6//4.8/9.6	34	12.2	19, 68
	1725	230/115	56	Auto	C691	Century	√	\$589	F1	5.0/10.0	27	11.1	4, 17
	1140	115/230	56	Auto	C341	Century	√	\$1177	F1	8.6/4.3	38	13.2	18

FAN & BLOWER - CAPACITOR START MOTORS

RESILIENT BASE MOTORS (SINGLE & TWO-SPEED)

FEATURES:

- Open dripproof except as noted
- Service factor, as noted
- 40° C ambient
- Extended thru-bolts, as noted
- Ball bearings (except as noted)



HP	RPM	VOLTS	FRAME	OVER LOAD	CAT. NO.	MODEL NO.	STOCK	LIST PRICE	MULT. SYMB.	F.L. AMPS	WT.	"C" DIM.	FOOT NOTES
1	3450	115/208-230	48	Auto	BF1102	Century®	√	\$638	F1	15.4/7.7	23	11.6	112, 66, Q
	3450	115/208-230	56	Auto	BK1102	Century	√	\$638	F1	15.4/7.7	24	11.9	112, 66, Q
	3450	208-230/115	56	Auto	B589	Century	√	\$571	F1	6.6-6.0/12.0	30	11.4	19
	3450	208-230/115	56	None	B703	Century	√	\$606	F1	6.6-6.0/12.0	30	11.4	19
	3450	208-230/115	56	Auto	B701	Century	√	\$556	F1	6.6-6.0/12.0	28	11.4	4, 19
	1725/1425	115/208-230	56H	Auto	RS1104AV1	Century	√	\$770	F1	14.4/6.6-7.2	32	11.8	4, 19, 68
	1725/1425	115/208-230	56	Auto	RB1104AV1	Century	√	\$719	F1	14.4/6.6-7.2	31	11.8	19, 57, 68
	1725	208-230/115	56Z	Auto	C523V1	Century	√	\$716	F1	6.2-6.3/12.6	32	11.9	18, 92, 122
	1725	208-230/115	56	None	C524	Century	√	\$663	F1	6.2-6.3/12.6	31	11.4	19
	1725	208-230/115	56	Auto	C692	Century	√	\$770	F1	6.2-6.3/12.6	32	11.4	4, 19
	1725	230/115	56	Auto	C766	Century	√	\$802	F1	6.5/13.0	30	11.4	4, 17
	1140	115/230	56	None	C343	Century	√	\$1118	F1	12.8/6.4	45	13.2	18
	1 1/2	3450	208-230/115	56	Auto	B722L	Century	√	\$722	F1	8.6-8.0/16.0	37	12.2
1725		208-230/115	56	Auto	C621	Century	√	\$832	F1	7.8-7.5/15.0	41	12.7	1, 110
1725/1425		115/208-230	56H	Auto	RB1154AV1	Century	√	\$832	F1	19.2/9.6	45	12.8	57, 68, 110
2	1725	115/208-230	56H	Auto	RB1204AV1	Century	√	\$1051	F1	22.0/11.0	43	12.8	18, 57

FAN & BLOWER - SPLIT PHASE MOTORS

RESILIENT BASE MOTORS (SINGLE & TWO-SPEED)



FEATURES:

- Ball bearings (except as noted)
- 1.0 service factor (except as noted)
- Extended thru-bolts, as noted

TOTALLY ENCLOSED

HP	RPM	VOLTS	FRAME	OVER LOAD	CAT. NO.	MODEL NO.	STOCK	LIST PRICE	MULT. SYMB.	FL. AMPS	WT.	"C" DIM.	FOOT NOTES
1/2	1725	115	56	Manual	F352V1	Century®	√	\$559	F1	7.0	25	11.1	92

TEFC

HP	RPM	VOLTS	FRAME	OVER LOAD	CAT. NO.	MODEL NO.	STOCK	LIST PRICE	MULT. SYMB.	FL. AMPS	WT.	"C" DIM.	FOOT NOTES
1/4	1140	115	56	None	F341	Century	√	\$785	F1	5.0	27	12.6	
1/2	1725	115	56	Auto	F352	Century	√	\$562	F1	7.0	28	12.6	AI
3/4	1725	115/208-230	56	Auto	F353	Century	√	\$779	F1	11.0/5.4-5.5	33	12.9	

TEAO (TENV AS NOTED)

HP	RPM	VOLTS	FRAME	OVER LOAD	CAT. NO.	MODEL NO.	STOCK	LIST PRICE	MULT. SYMB.	FL. AMPS	WT.	"C" DIM.	FOOT NOTES
1/6	1725	115/208-230	48Y	Auto	ARB2014L	Century	√	\$400	F1	2.8/1.4-1.4	14	8.8	32
	1725	115/208-230	48Y	None	ARB2014L2	Century	√	\$393	F1	2.8/1.4-1.4	14	8.8	32
	1140	115	56Z	Manual	ARB2016M	Century	√	\$463	F1	3.8	23	10.4	4, 32, 127
	1140	115/208-230	48	Auto	ARB2016SV1	Century	√	\$487	F1	4.0/1.9-2.0	19	9.9	32
	1140	115/208-230	48	None	ARB2016SLV1	Century	√	\$471	F1	4.0/1.9-2.0	18	9.9	32
1/4~1/12	1725/1140	115	56Z	Auto	ARB2024L1	Century	√	\$494	F1	4.4/3.0	25	11.0	53, 94, 130
	1725/1140	115	56Z	None	ARB2024L2	Century	√	\$482	F1	4.4/3.0	24	11.0	53, 94, 130
1/4	1725	115	48	None	ARS2020L	Century	√	\$388	F1	4.2	14	9.4	4, 32
	1725	115	48	Auto	904L	Century	√	\$490	F1	3.1	17	10.3	N
	1725	115	56Z	Auto	ARB2024ML	Century	√	\$414	F1	3.3	17	9.7	8, 31
	1725	115/208-230	48Y	Auto	ARB2024L3	Century	√	\$418	F1	3.3/1.7-1.7	16	9.4	32
	1725	115/208-230	48Y	None	ARB2024L4	Century	√	\$405	F1	3.3/1.7-1.7	20	9.4	32
	1140	115/208-230	48Y	Auto	ARB2026SV1	Century	√	\$465	F1	6.2/2.8-3.1	19	10.2	32
	1140	115/208-230	48Y	None	ARB2026SLV1	Century	√	\$447	F1	6.2/2.8-3.1	19	10.2	32
1/3~1/9	1725/1140	115	56Z	Auto	ARB2034L1	Century	√	\$492	F1	5.5/4.0	29	11.0	53, 94, 130
	1725/1140	115	56Z	None	ARB2034L3	Century	√	\$482	F1	5.6/3.2	29	11.0	53, 94, 130
1/3	1725	115	48	Auto	906L	Century	√	\$531	F1	4.4	22	10.7	N
	1725	115/208-230	48	Auto	ARB2034L6	Century	√	\$451	F1	4.9/2.3-2.5	18	9.8	32
	1725	115/208-230	56Z	None	ARB2034L4	Century	√	\$463	F1	5.6/2.8	24	10.0	20
	1725	115/208-230	48	None	ARB2034L2	Century	√	\$439	F1	4.9/2.3-2.5	18	9.8	32
	1725	115/208-230	56Z	Auto	ARB2034L5	Century	√	\$482	F1	7.3/3.8-3.8	24	10.0	20
	1140	115/208-230	56	Auto	ARB2036S	Century	√	\$527	F1	6.0/3.0-3.0	28	11.4	32
	1140	115/208-230	56	None	ARB2036SL	Century	√	\$510	F1	6.0/3.0-3.0	28	11.4	32
1/2~1/4	1725/1140	115	56	Auto	ARB2054L1	Century	√	\$554	F1	8.2/5.3	32	11.8	31
	1725/1140	115	56	None	ARB2054L2	Century	√	\$548	F1	8.2/5.3	24	11.8	31
1/2	1725/1425	115/208-230	56	Auto	ARB2054L3	Century	√	\$474	F1	8.0/3.6-4.0	24	10.8	94, 111
	1725	115/230	56	Auto	ARS2050DV1	Century	√	\$496	F1	7.0/3.5	24	10.8	4, 31
	1725	115/208-230	56	Auto	ARB2054L4	Century	√	\$462	F1	8.0/3.6-4.0	23	10.8	
3/4	1075	115/230	56	Auto	C060	Century	√	\$543	F1	7.3/3.7	31	11.3	2, 92, 93, N

FAN & BLOWER - SPLIT PHASE AND CAPACITOR START MOTORS

TOTALLY ENCLOSED, RESILIENT BASE MOTORS (SINGLE & TWO SPEED)

FEATURES:

- Thermal protection, as noted
- 1.0 service factor (except as noted)
- Heavy gauge steel frame and base
- Split phase (except as noted)
- Ball bearings
- UL recognized and CSA certified



HP	RPM	VOLTS	FRAME	OVER LOAD	CAT. NO.	MODEL NO.	STOCK	LIST PRICE	MULT. SYMB.	FL. AMPS	WT.	"C" DIM.	FOOT NOTES
1/6	1725	115	48	NONE	HG178	5KH32EN79	√	\$386	F1	4.0	15	9.92	
	1725	115	48	AUTO	H291	5KH32EN72X	√	\$406	F1	4.0	15	9.92	CF, 31
	1140	115	48	NONE	H233	5KH36PN109	√	\$534	F1	4.0	23	10.98	
1/4	1725	115	48	AUTO	H234	5KH39QN9105X	√	\$282	F1	5.1	17	9.92	
	1725	115	48	NONE	B1502	5KH39QN9105	√	\$271	F1	5.1	17	9.92	
	1725	115/230	48	NONE	C247	5KC32GN13	√	\$478	F1	5.4/2.7	17	9.92	2
	1725/1140	115	48	NONE	HG189	5KH36PN108	√	\$534	F1	4.2/2.7	23	10.98	
	1140	115/230	56	NONE	HG182	5KH49MN6060	√	\$615	F1	5.6/2.8	25	11.54	
1/3	1725	115	56	NONE	B1504	5KH35MN56	√	\$335	F1	5.9	20	10.93	
	1725	115	56	AUTO	H236	5KH35MN56X	√	\$346	F1	5.9	20	10.93	
	1725/1140	115	56	NONE	H190	5KH49MN3035	√	\$663	F1	5.7/3.2	27	11.54	
	1140	115	56	NONE	HG186	5KH46PN6059	√	\$708	F1	7.0	31	11.94	
1/2	1725	115	56	AUTO	B506	056S17F5303		\$475	F1	8.4	27	12.30	
	1725	115	56	NONE	B1507	5KH42GN0336	√	\$402	F1	8.0	21	11.11	19
	1725	115/230	56	AUTO	C289	5KC42GN0309X	√	\$645	F1	8.6/4.3	21	11.11	2, 18
	1725/1140	115	56	NONE	HG191	5KH46PN3033	√	\$738	F1	8.0/4.2	29	11.94	
	1725/1140	230	56	NONE	H293	5KH46PN3034	√	\$757	F1	3.8/1.9	31	11.94	
	1140	115	56	NONE	HG188	5KH49UN6064	√	\$900	F1	9.0	40	13.07	
3/4	1725	115/230	56	AUTO	C806	5KC49PN0281X	√	\$751	F1	11.0/5.5	32	12.54	2
1	1725	115/230	56	AUTO	C292	5KC49TN0285X	√	\$829	F1	13.2/6.6	38	13.07	2

FAN & BLOWER - THREE PHASE

TENV, RESILIENT BASE

APPLICATIONS:

Designed for applications like commercial fans and blowers, direct and belt drive air handlers and exhaust fans.

FEATURES:

- Ball bearings
- 1.0 service factor
- 5/8" extended thru-bolts
- UL recognized and CSA certified



HP	RPM	VOLTS	FRAME	CAT. NO.	MODEL NO.	STOCK	LIST PRICE	MULT. SYMB.	FL. AMPS	WT.	"C" DIM.	FOOT NOTES
1/4	1800	230/460	48	K281	5K32GN48	√	\$449	F1	1.4/0.7	14	8.94	
	1200	230/460	56	K282	5K35MN294	√	\$645	F1	1.4/0.7	18	9.89	
1/3	1800	230/460	48	K283	5K33KN52	√	\$504	F1	1.5/0.8	16	9.19	
1/2	1800	208-230/460	56	K284	5K42HN4128	√	\$566	F1	2.3-2.2/1.1	22	10.05	
	1200	208-230/460	56	K285	5K49MN6080	√	\$757	F1	2.6-2.6/1.3	24	10.48	
	1200	208-230/460	56	K541	K549MN6081	√	\$819	F1	2.6-2.6/1.3	27	11.54	
3/4	1800	208-230/460	56	K286	5K49KN4142	√	\$610	F1	3.3-3.0/1.5	21	10.48	
1	1800	230/460	56	K525A	056T17F15661	√	\$724	F1	3.3/1.65	30	13.04	

FAN & BLOWER - THREE PHASE, DRIPPROOF MOTORS

RESILIENT BASE MOTORS (SINGLE AND TWO-SPEED)

FEATURES:

- Single and two-speed models, as noted
- Variable torque on two speed ratings
- Ball bearings
- Heavy gauge steel frame and base
- Thermal protection, as noted
- Service factor, as noted
- Nameplated 60/50 Hz at next lower horsepower (except as noted)
- Patented VCD™, Voltage Change Device where footnoted "VC"
- UL recognized and CSA certified



As
Noted

HP	RPM	VOLTS	FRAME	OVER LOAD	CAT. NO.	MODEL NO.	STOCK	LIST PRICE	MULT. SYMB.	FL. AMPS	WT.	"C" DIM.	FOOT NOTES
1/4	1800	230/460	48Z	NONE	K275	5K33GN45		\$426	F1	1.4/0.7	14	9.57	20
1/3	1800/1200	460	56	NONE	G161	056T17D5701		\$561	F1	0.6/0.4	33	12.35	20
	1800	208-230/460	56	AUTO	G106	056T17D2104	✓	\$446	F1	1.5-1.6/8	16	9.97	20
	1800	208-230/460	56	NONE	G162	056T17D2121	✓	\$370	F1	1.5-1.6/8	16	9.97	20
	1800	575	56	NONE	G964	056T17D2117	✓	\$370	F1	0.64	16	9.97	20, 70
1/2	1800/1200	200-230	56	NONE	K544	5K42JN3051	✓	\$609	F1	2.4-2.8/1.5-1.7	23	10.05	19
	1800/1200	460	56	NONE	K546	5K42JN3050	✓	\$609	F1	1.1/0.6	22	10.05	19
	1800	208-230/460	56	AUTO	K1408	5K42HN4089X	✓	\$494	F1	2.3-2.2/1.1	20	10.05	19
	1800	208-230/460	56	NONE	K381	5K42HN4089	✓	\$418	F1	2.3-2.2/1.1	20	10.05	19
	1800	208-230/460	56	AUTO	G140	056T17D5345	✓	\$516	F1	2.3-2.4/1.2	22	10.85	VC, 19
	1800	575	56	NONE	G961	056T17D2118	✓	\$416	F1	0.9	18	10.47	19, 70
3/4	3600	208-230/460	56	AUTO	K1409	5K37MN252X	✓	\$453	F1	2.6-2.6/1.3	16	10.72	19
	1800/1200	200-230	56	NONE	K279	5K49PN3053	✓	\$724	F1	2.8-3.0/1.6-1.8	31	11.48	19
	1800/1200	460	56	NONE	K280	5K49PN3052	✓	\$724	F1	1.3/0.7	28	11.48	19
	1800	208-230/460	56	AUTO	K1410	5K46KN4085X	✓	\$540	F1	3.3-3.0/1.5	21	10.88	19
	1800	208-230/460	56	AUTO	G141	056T17D5346	✓	\$564	F1	2.9-3.0/1.5	23	10.85	VC, 19
	1800	208-230/460	56	NONE	K277	5K46KN4085	✓	\$467	F1	3.3-3.0/1.5	24	10.88	19
	1800	575	56	NONE	G962	056T17D2119	✓	\$465	F1	1.1	21	10.97	19, 70
	1	3600	208-230/460	56	AUTO	K1411	5K38PN258X	✓	\$504	F1	3.3-3.2/1.6	18	11.32
1	1800/1200	200-230	56	NONE	K518	5K49SN3054	✓	\$749	F1	3.7-3.9/2.0-2.2	35	12.01	18
	1800/1200	460	56	NONE	K519	5K49SN3055	✓	\$749	F1	1.8/1.1	35	12.01	18
	1800	208-230/460	56	AUTO	K1412	5K46MN4087X	✓	\$574	F1	3.6-3.8/1.9	27	10.88	18
	1800	208-230/460	56	AUTO	G142	056T17D5347	✓	\$574	F1	3.5-3.6/1.8	25	11.35	VC, 18
	1800	208-230/460	56H	AUTO	G100	056T17D2101	✓	\$551	F1	3.4-3.4/1.7	24	11.47	5, 18
	1800	208-230/460	56	NONE	K278	5K46MN4087	✓	\$480	F1	3.6-3.8/1.9	27	10.88	18
	1800	575	56H	NONE	G963	056T17D2120	✓	\$478	F1	1.4	23	11.47	5, 18, 70
	1 1/2	3600	208-230/460	56H	AUTO	K1413	5K49KN2150X	✓	\$601	F1	5.0-4.8/2.4	26	12.01
1 1/2	1800/1200	200-230	56H	NONE	K520	5K48UN3056	✓	\$771	F1	5.0-5.3/2.8-3.1	40	12.76	18
	1800/1200	460	56H	NONE	K549	5K48UN3057	✓	\$771	F1	2.3/1.4	40	12.76	18
	1800	208-230/460	56	NONE	G122	056T17D5329	✓	\$531	F1	4.8-4.8/2.4	28	11.35	18
	1800	208-230/460	56H	AUTO	K1415	5K49PN4088X	✓	\$602	F1	5.5-5.6/2.8	31	12.01	18
	1800	208-230/460	56	AUTO	G143	056T17D5348	✓	\$626	F1	4.8-4.8/2.4	28	11.35	VC, 18
	1800	208-230/460	145T	AUTO	K2030A	-	✓	\$704	E6	4.5-4.4/2.2	40	13.19	18, 70
	1800	575	56H	AUTO	G965	056T17D5357	✓	\$601	F1	1.9	29	11.35	18, 70
	2	3600	208-230/460	56H	AUTO	K1416	5K49NN2147X	✓	\$693	F1	6.0-6.0/3.0	30	12.01
2	1800	208-230/460	56H	AUTO	G144	056T17D5349	✓	\$693	F1	6.2-6.2/3.1	35	12.35	VC, 5, 18
	1800	208-230/460	56H	NONE	G127	056T17D5332	✓	\$580	F1	6.2-6.2/3.1	34	12.35	5, 18
	1800	208-230/460	56H	AUTO	K1418	5K49UN4086X	✓	\$657	F1	6.2-6.0/3.0	39	13.96	5, 18
	1800	575	56H	AUTO	G967	056T17D5385	✓	\$655	F1	2.5	36	12.35	5, 18, 70
	3	3600	208-230/460	56HZ	AUTO	B193	056T34D5357	✓	\$778	F1	8.9-8.4/4.2	34	12.22
3	3600	208-230/460	145T	AUTO	K2037A	-	✓	\$819	E6	8.4-7.6/3.8	44	13.19	18, 70
	1800	208-230/460	56HZ	AUTO	G145	056T17D5350	✓	\$730	F1	9.2-8.6/4.3	48	14.22	Z, VC, 5, 18
	1800	208-230/460	56HZ	AUTO	K1497	5K49WN4335X	✓	\$810	F1	10.2/4.8	44	15.31	11, 18
5	3600	208-230/460	56HZ	AUTO	X251	056T34D5364	✓	\$1,042	F1	13.5-12.4/6.2	50	13.49	Z, 5, 12, 17, 70

FAN & BLOWER - THREE PHASE, DRIPPROOF MOTORS

RESILIENT BASE MOTORS (SINGLE & TWO-SPEED)

FEATURES:

- Dripproof, except RB3104A is open
- Service factor, as noted
- Ball bearings (except as noted)
- Extended thru-bolts, as noted
- Continuous duty



HP	RPM	VOLTS	FRAME	OVER LOAD	CAT. NO.	MODEL NO.	STOCK	LIST PRICE	MULT. SYMB.	FL. AMPS	WT.	"C" DIM.	FOOT NOTES
1/3	1725/1425	200-230/460	48Y	None	H264A	Century®	√	\$575	F1	1.1-1.2/6	17	9.60	20, 68
	1725	200-230/460	56	None	H262V2	Century	√	\$484	F1	1.4-1.6/8	21	11.10	20
1/2	1725	208-230/460	56	Auto	BK3054V1	Century	√	\$641	F1	2.0/1.0	22	11.40	19, 92
	1725	460/200-230	56	None	H275V2	Century	√	\$503	F1	1.0/1.8-2.0	22	11.10	19, 92
	1725	460/200-230	56	Auto	H850L	Century	√	\$657	F1	1.0/1.9-2.0	22	12.20	19
	1725	575	56	None	H957L	Century	√	\$597	F1	0.88	36	10.10	19
	1725	200-230/460	56	None	H582V2	Century	√	\$577	F1	2.7-2.8/1.4	22	10.10	19, 92
3/4	1725	208-230/460	56H	Auto	BK3074	Century	√	\$707	F1	2.9/1.45	22	11.90	19
	1725	460/200-230	56	Auto	H851V2	Century	√	\$674	F1	1.5/2.8-3.0	24	12.20	19, 92
	1725	575	56	Auto	H941L	Century	√	\$725	F1	0.90	28	11.10	19
	1725	230/460	56H	Auto	BK3102	Century	√	\$657	F1	4.1/2.05	22	11.90	112
1	3450	575	56H	Auto	H950	Century	√	\$672	F1	1.5	27	12.70	112
	1725	200-230/460	56	None	H615V2	Century	√	\$600	F1	3.4-3.6/1.8	25	11.10	19, 92
	1725	208-230/460	56H	Auto	RB3104A	Century	√	\$693	F1	3.6/1.8	28	11.80	19, 68
	1725	460/200-230	56U	Auto	H852L	Century	√	\$693	F1	2.0/3.7-4.0	27	12.70	18
	1725	575	56H	Auto	H942L	Century	√	\$740	F1	1.5	32	12.70	18
	1725	460/200-230	56H	Auto	H843V1	Century	√	\$787	F1	2.3/4.7-4.6	33	12.90	92, 111, Q
1 1/2	1725	200-230/460	56H	None	H536L	Century	√	\$660	F1	5.3-5.6/2.8	35	12.20	110
	1725	208-230/460	56H	Auto	RB3154A	Century	√	\$743	F1	5.0/2.5	30	11.80	18, 68, 126
	1725	208-230/460	56HZ	Auto	RB3154AV1	Century	√	\$778	F1	5.0/2.5	30	12.30	18, 68, 126, Z
	1725	460/200-230	56H	Auto	H853V2	Century	√	\$739	F1	2.8/5.0-5.6	30	12.90	18
	1725	575	56	Auto	H943V1	Century	√	\$817	F1	2.0	31	11.70	110
	3450	200-230/460	56H	Auto	BK3202L	Century	√	\$846	F1	6.0-5.8/2.9	36	13.90	92, 110
	3450	460/200-230	56H	Auto	H844	Century	√	\$850	F1	2.9/6.0-5.8	34	13.90	110, Q
2	3450	575	56H	Auto	H952	Century	√	\$933	F1	2.4	35	13.90	110
	1725	208-230/460	56H	None	RB3204	Century	√	\$819	F1	7.4/3.7	33	12.80	18, 68, 126
	1725	208-230/460	56H	Auto	RB3204A	Century	√	\$832	F1	6.2/3.1	38	12.80	18, 68, 126
	1725	208-230/460	56HZ	Auto	RB3204AV1	Century	√	\$862	F1	6.2/3.1	38	13.30	18, 68, 126
	1725	460/200-230	56HZ	Auto	H854L	Century	√	\$905	F1	3.5/6.6-7.0	39	13.80	18, Z
	3450	460/200-230	56HZ	Auto	H845	Century	√	\$1055	F1	4.3/9.0-8.6	38	13.80	18, Z, Q
	3450	575	56HZ	Auto	H954	Century	√	\$1055	F1	3.6	37	13.80	18, Z
	1725	460/200-230	56HZ	Auto	H855L	Century	√	\$922	F1	4.4/9.0-8.8	44	14.60	18, Z
5	3450	208-230/460	56HZ	Auto	H1039L	Century	√	\$922	F1	13.4-13.2/6.6	50	14.60	18, Z

FAN & BLOWER - THREE PHASE MOTORS

RESILIENT BASE MOTORS

FEATURES:

- Ball bearings (except as noted)
- 1.15 service factor
- TENV, except H1031L is TEAO
- 7/8" extended thru-bolts, shaft-end
- Continuous duty



HP	RPM	VOLTS	FRAME	OVER LOAD	CAT. NO.	MODEL NO.	STOCK	LIST PRICE	MULT. SYMB.	FL. AMPS	WT.	"C" DIM.	FOOT NOTES
1/4	1140	200-230/460	56	None	H1026	Century®	√	\$645	F1	1.3-1.2/1.6	15	10.1	
1/2	1725	200-230/460	56	None	H1028V1	Century	√	\$736	F1	1.6-1.8/9	27	11.1	
	1140	200-230/460	56	None	H1029	Century	√	\$757	F1	2.1-2.0/1.0	27	11.1	
3/4	1725	200-230/460	56	None	H1030L	Century	√	\$610	F1	2.3-2.4/1.2	28	11.4	
1	1725	200-230/460	56	None	H1031L	Century	√	\$641	F1	3.3-3.4/1.7	30	11.5	

FAN & BLOWER - ADJUSTABLE RING MOUNT MOTORS

QUICK-FIT MOTORS

FEATURES:

- Split phase
- Service factor, as noted
- Resilient ring mount
- Auto protection
- Open dripproof
- Ball bearings (except as noted)



HP	RPM	VOLTS	FRAME	CAT. NO.	MODEL NO.	STOCK	LIST PRICE	MULT. SYMB.	FL. AMPS	WT.	"C" DIM.	APPROX. "R"	FOOT NOTES
1/4	1725	115	48	AR2024	Century	√	\$310	F1	5.4	13	9.5	7.1 to 8.4	4, 20, 53
1/3	1725	115	48	AR2034	Century	√	\$339	F1	6.0	15	10.6	7.4 to 8.7	20, 53
1/2	1725	115	48	AR2054	Century	√	\$369	F1	8.0	17	11.1	7.9 to 9.2	4, 19, 53

FURNACE BLOWER, SPLIT PHASE MOTORS

OPEN, PDQ MOUNTING

APPLICATIONS:

Designed for replacement of virtually any NEMA® 48 and 56 frame belt drive furnace blower motors. PDQ models have 1 1/2" extended splined hub on opposite shaft end for quick and easy positioning of resilient ring to properly fit the pre-existing motor base.

FEATURES:

- Ball bearings
- Reversible rotation connected for CCW rotation from factory
- NEMA service factors
- 4733, 4734 and 4735 have both 48 and 56 frame mounting holes and including mounting base
- UL recognized and CSA certified



HP	RPM	VOLTS	FRAME	OVER LOAD	CAT. NO.	MODEL NO.	STOCK	LIST PRICE	MULT. SYMB.	FL. AMPS	WT.	"C" DIM.	MIN/MAX BASE DIM'S	FOOT NOTES
1/4	1725	115	48Y	AUTO	4733	5KH39DNA533T	√	\$253	F1	5.1	13	9.78	6.62" & 7.91"	
	1725	115	48Y	AUTO	4730	5KH39QN9725T	√	\$233	F1	5.0	13	9.78	6.62" & 7.91"	30
1/3	1725	115	48Y	AUTO	4734	5KH32HNA532T	√	\$273	F1	6.6	15	10.03	6.87" & 8.16"	
	1725	115	48Y	AUTO	4731	5KH39QN9696X	√	\$250	F1	5.8	15	10.28	7.12" & 8.41"	30
	1725	230	48Y	AUTO	4738	5KH39QN9703T	√	\$408	F1	3.1	15	10.28	7.12" & 8.41"	30
1/2	1725	115	48Y	AUTO	4732	5KH39QN9702T	√	\$330	F1	7.9	17	10.66	7.50" & 8.79"	30
	1725	115	48Y	AUTO	4735	5KH33JNA534T	√	\$357	F1	7.9	15	10.28	6.62" & 7.91"	
	1725	230	48Y	AUTO	4739	5KH39QN9704T	√	\$515	F1	4.0	17	10.66	7.50" & 8.79"	30

NEMA is a trademark of National Electrical Manufacturers Association.
All Rights Reserved.

Prices and specifications are subject to change without notice.

EXHAUST VENTILATOR, SINGLE PHASE MOTORS

DRIPPROOF, C-FACE FOOTLESS, SINGLE SPEED MOTORS

FEATURES:

- Split phase (except as noted)
- Thermal protection, as noted
- Service factor, as noted
- Century® motors with 56CZ frames have 2-1/4 x 5/8 shaft dimensions
- Ball bearings
- Open dripproof except F396L is TENV



MARATHON® MOTORS

HP	RPM	VOLTS	FRAME	OVER LOAD	CAT. NO.	MODEL NO.	STOCK	LIST PRICE	MULT. SYMB.	FL. AMPS	WT.	"C" DIM.	FOOT NOTES
1/12	1140	115	56CZ	NONE	H204	5KH32GN142	√	\$394	F1	2.4	13	9.62	112
	850	115	56CZ	NONE	H205	5KH37PN37	√	\$571	F1	3.2	19	11.08	112
	850	115	56CZ	AUTO	H278	5KH37PN37X	√	\$585	F1	3.2	19	11.08	112
1/8	1140	115	56CZ	AUTO	H287	5KH36KN112X	√	\$454	F1	3.8	15	10.68	112
	1140	115	56CZ	NONE	H206	5KH36KN112	√	\$432	F1	3.8	15	10.68	112
	850	115	56CZ	NONE	H207	5KH46MN3041	√	\$700	F1	4.6	22	11.15	112
1/6	1725	115	56CZ	NONE	H208	5KH32DN111	√	\$231	F1	4.2	11	9.62	20
	1140/850	115	56CZ	NONE	H222	5KH49PN3047	√	\$687	F1	4.2/2.9	43	11.70	20
	1140	115	56CZ	AUTO	H210	5KH37PN36X	√	\$504	F1	4.0	19	11.08	20
	1140	115	56CZ	NONE	H209	5KH37PN36	√	\$352	F1	4.0	19	11.08	20
1/4	1725	115	56CZ	NONE	H212	5KH33FN77	√	\$245	F1	5.6	13	9.87	20
	1725	115	56CZ	AUTO	H213	5KH33FN77X	√	\$368	F1	5.6	13	9.87	20
	1725/1140	115	56CZ	NONE	H223	5KH37PN40	√	\$472	F1	4.2/2.7	20	11.08	20
	1140/850	115	56CZ	NONE	H224	5KH49SN3049	√	\$837	F1	5.8/3.6	29	11.91	20
	1140	115	56CZ	NONE	H214	5KH46MN6071	√	\$418	F1	5.6	22	11.15	20
	1140	115	56CZ	AUTO	H215	5KH46MN6071X	√	\$575	F1	5.6	22	11.15	20
	850	115	56CZ	AUTO	H288	5KH49SN3023X	√	\$983	F1	6.9	31	13.59	20
	1725	115	56CZ	NONE	H217	5KH35JN121	√	\$277	F1	6.6	14	10.25	20
1/3	1725	115	56CZ	AUTO	H218	5KH35JN121X	√	\$416	F1	6.6	14	10.25	20
	1725/1140	115	56CZ	NONE	H225	5KH46MN3040	√	\$587	F1	5.7/3.2	22	11.15	20
	1140	115	56CZ	NONE	H219	5KH49PN6069	√	\$689	F1	7.0	31	11.70	20
	850	115	56CZ	AUTO	H280	5KH49UN3024X	√	\$1,031	F1	9.2	40	13.59	20
	1725	115	56CZ	NONE	H290	5KH36MN137	√	\$367	F1	7.2	16	11.31	19
1/2	1725/1140	115	56CZ	AUTO	H282	5KH49PN3042X	√	\$708	F1	8.0/4.2	31	11.70	19
	1725/1140	115	56CZ	NONE	H226	5KH49PN3042	√	\$689	F1	8.0/4.2	26	11.70	19
	1140	115	56CZ	NONE	H221	5KH48UN6074	√	\$781	F1	9.0	34	12.66	19
	1140	115/208-230	56C	NONE	G278	056C11D5304	√	\$711	F1	10.6/5.1-5.3	32	11.94	2, 19



CENTURY® MOTORS

HP	RPM	VOLTS	FRAME	OVER LOAD	CAT. NO.	MODEL NO.	STOCK	LIST PRICE	MULT. SYMB.	FL. AMPS	WT.	"C" DIM.	FOOT NOTES
1/12	850	115	56CZ	Auto	F395	Century®	√	\$651	F1	2.6	24	11.10	112
1/8	1140	115	56CZ	Auto	F270	Century	√	\$495	F1	3.0	19	11.30	112
1/6	1140	115	56CZ	Auto	F271	Century	√	\$552	F1	3.6	18	11.30	20
1/4~1/12	1725/1140	115	56CZ	Auto	F393L	Century	√	\$572	F1	5.4/3.2	22	12.20	20
1/4	1725	115	48CY	None	F396L	Century	√	\$547	F1	3.1	16	11.80	17, N
	1725	115	56CZ	Auto	F392	Century	√	\$368	F1	5.3	13	9.90	20
	1140	115	56CZ	Auto	F273	Century	√	\$710	F1	5.0	25	11.30	20
1/3~1/11	850	115	56CZ	Auto	F274	Century	√	\$1189	F1	6.2	31	12.40	20
	1725/1140	115	56CZ	None	F252	Century	√	\$665	F1	5.0/3.0	24	11.30	20
	1725/1140	115	56CZ	Auto	F262	Century	√	\$685	F1	5.4/2.3	23	11.30	20
1/3	1725	115	56CZ	Auto	F394	Century	√	\$416	F1	6.8	15	10.20	20
	850	115	56CZ	Auto	F276V1	Century	√	\$1,243	F1	8.6	40	12.90	17
1/2~1/7	1725/1140	115	56CZ	Auto	F263	Century	√	\$858	F1	6.8/3.8	28	11.60	19

OIL BURNER, SPLIT PHASE AND CAPACITOR START MOTORS

NEMA® 48M AND 48N FLANGE MOUNT MOTORS

APPLICATIONS:

Direct replacement motors for residential and commercial oil burners and hot water pressure/steam cleaners.

FEATURES:

- Ball bearings (except as noted)
- 20" long leads from a 1/2" NPT opening
- Split phase and capacitor start designs
- Catalog numbers 4781, 4788, O010 and O011 have dripproof enclosures
- Semi- or totally enclosed steel frame (totally enclosed foot-noted with N)
- Two-bolt, NEMA® N- or M-flange direct mounting
- 1.0 service factor



HP	RPM	VOLTS	FRAME	OVER LOAD	CAT. NO.	MODEL NO.	STOCK	LIST PRICE	MULT. SYMB.	FL. AMPS	WT.	"C" DIM.	FOOT NOTES
1/8	3450	115	48N	MANUAL	O005	048S34S2004	√	\$204	F1	2.4	9	7.09	3, 61
	1725	115	48N	MANUAL	O600	048S17T286	√	\$179	F1	2.8	11	7.70	CF, N, 3
1/7	3450	115	48M	MANUAL	O100	048S34S361	√	\$220	F1	2.8	11	7.70	CF, 3
1/6	3450	115	48M	MANUAL	O102	048S34S2005	√	\$233	F1	3.0	11	7.25	3
	1725	115	48N	MANUAL	O601	048A17T290	√	\$191	F1	2.7	12	7.59	CF, N, 3
1/5	3450	115/230	48N	MANUAL	O012	048C34S24	√	\$271	F1	3.0/1.5	14	8.35	2, 61
1/4	3450	115	48N	MANUAL	4785	5KH32EN5015U	√	\$257	F1	4.1	13	8.13	D, 3, 4
	3450	115	48N	MANUAL	O004	048S34S2003	√	\$271	F1	4.2	13	8.13	CF, 3
	3450	115/230	48N	MANUAL	O013	048C34S2001	√	\$282	F1	4.4/2.2	19	8.60	2
	1725	115	48N	MANUAL	O002	048S17S25	√	\$231	F1	4.2	12	7.59	3
1/3	3450	115/230	48N	MANUAL	4788	5KC37EN3900U	√	\$296	F1	6.0/3.0	14	10.13	D
	3450	115/208-230	48N	MANUAL	O010	048C34D2024	√	\$296	F1	5.6/2.7-2.8	14	10.34	2
	3450	115	48N	MANUAL	4774	5KH33GN5014U	√	\$276	F1	4.9	15	8.38	3, 4
	1725	115	48N	MANUAL	O003	048S17S24	√	\$268	F1	5.0	17	8.34	3
1/2	3450	115/230	48N	MANUAL	4781	5KC37HN3898U	√	\$365	F1	8.2/4.1	15	10.13	
	3450	115/208-230	48N	MANUAL	O011	048C34D2028	√	\$365	F1	7.4/3.5-3.7	17	10.84	2

OIL BURNER, SINGLE PHASE MOTORS

NEMA 48M FLANGE MOUNT MOTORS

APPLICATIONS:

Replacement motors for mini pumps in residential or light commercial furnaces.

FEATURES:

- High efficiency design
- Ultra quiet performance
- 14" cord for easy connection
- UL recognized and CSA certified



HP	RPM	VOLTS	FRAME	OVER LOAD	CAT. NO.	MODEL NO.	STOCK	LIST PRICE	MULT. SYMB.	FL. AMPS	WT.	"C" DIM.	FOOT NOTES
1/7	3450	115	48M	AUTO	O701	048A34SU1001	√	\$190	F1	1.7	8	6.61	3, 61

OIL BURNER, SPLIT PHASE AND CAPACITOR START MOTORS

DRIPPROOF, NEMA® 56C, C-FACE FOOTLESS MOTORS

FEATURES:

- Ball bearings
- Split phase and capacitor start designs
- NEMA 56C direct mounting
- Moderate starting torque
- Manual or automatic reset thermal protector
- NEMA jet pump service factors (as noted)
- UL recognized and CSA certified



HP	RPM	VOLTS	FRAME	OVER LOAD	CAT. NO.	MODEL NO.	STOCK	LIST PRICE	MULT. SYMB.	FL. AMPS	WT.	"C" DIM.	FOOT NOTES
1/4	3600	115	56C	MAN	O200	056S34D2000	√	\$222	F1	4.3	14	10.19	3, 15, 115
1/3	3600	115	56C	AUTO	O201	056S34D93	√	\$210	F1	5.6	14	10.44	3, 15
	3600	115/230	56C	AUTO	J1025	5KC37FN71X	√	\$245	F1	6.4/3.2	14	10.71	2, 115
1/2	3600	115/208-230	56C	MAN	O211	056C34D2109	√	\$257	F1	5.6/2.7-2.8	14	10.44	2, 115
	3600	115/208-230	56C	AUTO	O210	056C34D2114	√	\$245	F1	5.6/2.7-2.8	14	10.44	2, 115
1/2	3600	115/208-230	56C	MAN	O213	056C34D2099	√	\$281	F1	7.4/3.5-3.7	16	10.69	2, 114
	3600	115/208-230	56C	AUTO	O212	056C34D2098	√	\$269	F1	7.4/3.5-3.7	17	10.69	2, 114
3/4	3600	115/230	56C	AUTO	C330	5KC36JN268X	√	\$269	F1	7.6/3.8	17	10.31	2, 114
	3600	115/208-230	56C	MAN	O215	056C34D2112	√	\$327	F1	9.8/4.8-4.9	18	10.94	2, 113
3/4	3600	115/208-230	56C	AUTO	O214	056C34D2104	√	\$317	F1	9.8/4.8-4.9	20	10.94	2, 113
	3600	115/230	56C	AUTO	C332	5KC39NN50X	√	\$317	F1	11.2/5.6	22	11.84	2, 113
1	3600	115/230	56C	AUTO	C334	5KC39RN44X	√	\$355	F1	13.2/6.6	22	12.59	2, 112
	3600	115/208-230	56C	MAN	O217	056C34D2105	√	\$367	F1	12.0/6.2-6.0	24	11.94	2, 112
1 1/2	3600	115/208-230	56C	MAN	O231	056B34D2028	√	\$497	F1	13.4/7.4-6.7	25	11.97	1, 111
	3600	115/208-230	56C	AUTO	C336	5KC49NN2140X	√	\$485	F1	18.4-9.8/9.2	27	11.38	1, 111
2	3600	115/208-230	56C	AUTO	C338	5KC49TN2141X	√	\$601	F1	21.2-11.5/10.6	38	13.22	1, 110
	3600	115/208-230	56C	MAN	O232	056B34D5337	√	\$615	F1	19.2/10.3-9.6	33	11.44	1, 110
3	3600	115/230	56C	AUTO	C340	5KCR48TN2142T	√	\$955	F1	29.4/14.7	38	12.66	1, 18

OIL BURNER, THREE PHASE MOTORS

DRIPPROOF, NEMA 56C C-FACE FOOTLESS MOTORS

FEATURES:

- Double sealed ball bearings
- NEMA jet pump service factors
- NEMA 56C direct mounting
- Ball bearings
- UL recognized and CSA certified



HP	RPM	VOLTS	FRAME	OVER LOAD	CAT. NO.	MODEL NO.	STOCK	LIST PRICE	MULT. SYMB.	FL. AMPS	WT.	"C" DIM.	FOOT NOTES
1/3	3600	208-230/460	56C	NONE	KG215	5K35FN55	√	\$282	F1	1.5-1.8/0.9	14	9.88	68, 115
1/2	3600	208-230/460	56C	NONE	K216	5K36JN57	√	\$320	F1	2.0-2.0/1.0	15	10.31	68, 114
3/4	3600	208-230/460	56C	NONE	K218	5K37MN37	√	\$386	F1	2.6-2.6/1.3	17	10.70	68, 113
1	3600	208-230/460	56C	NONE	K220	5K38PN47	√	\$438	F1	3.3-3.2/1.6	20	11.30	68, 112
1 1/2	3600	208-230/460	56C	NONE	K222	5K46KN2173	√	\$534	F1	5.0-4.8/2.4	24	10.73	68, 111
2	3600	208-230/460	56C	NONE	K224	5K49NN2180	√	\$625	F1	6.0-6.0/3.0	27	11.33	68, 110
3	3600	208-230/460	56C	NONE	K226	5K48TN2182	√	\$701	F1	8.9-8.2/4.1	36	12.61	18, 68

OIL BURNER, SINGLE PHASE MOTORS

NEMA® 48M AND 48N FLANGE MOUNT MOTORS

APPLICATIONS:

Domestic high and low pressure oil burners.

FEATURES:

- Reversible rotation except as noted
- External reversing switch as noted
- Sleeve bearing except for OBK6002V1 and OL1072D
- 1.0 service factor except as noted
- Split phase designs except as noted



HP	RPM	VOLTS	FRAME	OVER LOAD	CAT. NO.	MODEL NO.	STOCK	LIST PRICE	MULT. SYMB.	FL. AMPS	WT.	"C" DIM.	FOOT NOTES
1/8	1725	115	48N	Manual	EL2005	Century®	√	\$238	F1	2.5	10	7.16	139
1/7	3450	115	48M	Manual	EL2002V1	Century	√	\$262	F1	2.5	10	7.41	16, 135
	3450	115	48M	Manual	OBK6002V1	Century	√	\$261	F1	1.8	7	6.71	15, 93, 135
1/6	1725	115	48N	Manual	XEL2014	Century	√	\$273	F1	3.2	13	7.66	139
1/4	3450	115	48N	Manual	EL2022	Century	√	\$277	F1	3.4	18	8.66	135
1/3	1725	115	48N	Manual	OL2034	Century	√	\$299	F1	4.3	18	8.66	135
	1725	115	48N	Manual	EL2034	Century	√	\$295	F1	4.3	28	11.22	Q
	3450	115/230	48N	Manual	OL2032	Century	√	\$290	F1	4.2/2.1	18	8.66	135
1/2	3450	115/230	48N	Manual	OL2052D	Century	√	\$365	F1	6.2/3.1	18	8.66	68, 135
	3450	115/230	48N	Manual	OL1052DS	Century	√	\$370	F1	7.3/3.7	23	12.41	2, 19, 144, Q
3/4	3450	115/208-230	48CZ	Manual	OL1072D	Century	√	\$393	F1	10.0/5.0	20	10.81	2, 108, 135, Q

REFRIGERATION FAN, PSC, OPEN AIR OVER MOTORS

RESILIENT RING & THRU-BOLT MOUNT MOTORS

FEATURES:

- Open end bracket
- Ball bearings
- Automatic reset thermal protector
- BX connector included in frame (except on catalog # X262)
- Catalog # X263 and X264 have 12" cord and molded plug
- UL recognized and CSA certified
- Capacitor included (except on catalog # X262 and X426)



HP	RPM	VOLTS	FRAME	CAT. NO.	MODEL NO.	STOCK	LIST PRICE	MULT. SYMB.	FL. AMPS	WT.	FRAME LENGTH	SHAFT DIM.	FOOT NOTES
1/6	1625	208-230	48Y	X269	048A17O147	√	\$320	F1	1.2	11	5.00	1/2 x 1 1/2	15
1/4	1625	208-230	48Y	X270	048A17O149	√	\$344	F1	1.9	12	5.69	1/2 x 2 1/2	16
	1075	460	48Y	X264	048A11O11040		\$281	F1	0.8	13	3.20	1/2 x 3 3/4	16
	1075	208-230	48Y	X263	048A11O11041		\$276	F1	2.0	13	4.25	1/2 x 3 3/4	16
	1075	208-230	48Y	X262	048A11D245	√	\$290	F1	1.8	15	7.25	1/2 x 1 5/8	67, 69, 82
1/3	1625	208-230	48YZ	X230	048A17O136	√	\$288	F1	1.8	14	5.69	1/2 x 3 1/2	15
	1075	208-230	48YZ	X268	048A11O1239	√	\$352	F1	3.0	14	5.69	1/2 x 2 1/2	15
3/4	1075	460	48YZ	X426	048A11O1375	√	\$430	F1	2.2	19	6.38	5/8 x 4 1/2 w/ key	67, 69

REFRIGERATION FAN MOTORS, THREE PHASE MOTORS

OPEN AIR OVER, SHAFT UP & HORIZONTAL RIGID BASE MOUNT MOTORS

APPLICATIONS:

Replacement motor for refrigeration equipment.

FEATURES:

- 70°C ambient
- Enclosed shaft end bracket, vented frame
- Continuous duty
- Automatic reset thermal protector
- Shaft slinger
- Threaded lead exit
- Nameplated 60/50 hertz 190/380 volts, at next lower HP

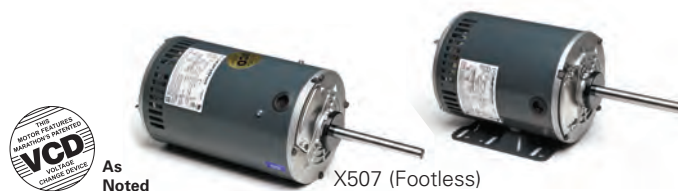

- Double sealed ball bearings
- Flat and keyway on shaft
- Patented VCD, Voltage Change Device
- Ball bearings
- UL recognized and CSA certified

HP	RPM	VOLTS	FRAME	CAT. NO.	MODEL NO.	STOCK	LIST PRICE	MULT. SYMB.	FL. AMPS	WT.	FRAME LENGTH	SHAFT DIM.	FOOT NOTES	
1/2	850	208-230/460	56HZ	X529	056T8O5531	√	\$872	F1	2.9-3.0/1.5	31	9.62	5/8 x 5	VC, 5	
	1	850	208-230/460	56HZ	X528	056T8O5306	√	\$979	F1	5.1-5.3/2.65	49	10.62	5/8 x 5	VC, 5
		850	208-230/460	56Y	X507	056T8O5302	√	\$951	F1	5.3-5.3/2.6	46	12.00	5/8 x 5	VC
		850	575	56Y	K1511	5K48WN3181S		\$897	F1	2.0	44	10.77	5/8 X 6	
1 1/2	1140	208-230/460	56HZ	X523	056T11O5306	√	\$798	F1	5.45-5.4/2.7	36	11.00	5/8 x 5	VC, 5	
	850	208-230/460	56HZ	X531	056T8O15504	√	\$1,065	F1	7.0-7.0/3.5	47	11.50	5/8 x 5	VC, 5	
2	1140	208-230/460	56HZ	X525	056T11O5310	√	\$865	F1	7.2-6.8/3.4	47	12.00	5/8 x 5	VC, 5	

UNIT HEATER FAN, PSC, TEAO MOTORS

RESILIENT BASE MOTORS

APPLICATIONS:

Replacement motors for unit heaters. Air over motors need to be mounted within the airstream for proper cooling.

FEATURES:

- Totally enclosed
- Direct drive, air over
- Ball bearings
- Horizontal or vertical mount
- Weather resistant reversing plug
- BX connector mounted in frame
- 1" extended thru-bolts
- Automatic reset thermal protection
- UL recognized and CSA certified
- Capacitor included
- 48Y frame has non-standard BA dimension



HP	RPM	VOLTS	FRAME	CAT. NO.	MODEL NO.	STOCK	LIST PRICE	MULT. SYMB.	F.L. AMPS	WT.	FRAME LENGTH	SHAFT DIM.	FOOT NOTES
1/6	1625	115	48Y	X305	048A17T2001	√	\$261	F1	2.0	13	4 3/4	1/2 x 2 3/4	
	1625	115	48Y	X301	048A17T72	√	\$233	F1	2.0	13	5 1/4	1/2 x 2 3/4	
	1075	115	48Y	X302	048A11T199	√	\$271	F1	3.0	13	4 3/4	1/2 x 2 3/4	
1/4	1075	115	48Y	X303	048A11T198	√	\$284	F1	4.1	14	4 3/4	1/2 x 2 3/4	
1/3	1075	115	48Y	X304	048A11T201	√	\$314	F1	6.5	21	6	1/2 x 2 3/4	

CIRCULATOR PUMP, SPLIT PHASE MOTORS

DRIPPROOF, RESILIENT RING MOUNT MOTORS

FEATURES:

- Ball bearing construction
- 1.40 service factor (except as noted)
- Fixed CCW rotation, viewed opposite shaft end, as noted
- UL recognized and CSA certified
- 4722 replaces 110-388, Marathon No. 48S17D1027, 48S17D2102
- 4404 replaces Marathon No. 48S17D1084



HP	RPM	VOLTS	FRAME	CAT. NO.	MODEL NO.	STOCK	LIST PRICE	MULT. SYMB.	F.L. AMPS	WT.	"C" DIM.	FOOT NOTES
1/12	1800	115	48Y	4722	5KH39QN5558T	√	\$185	F1	2.1	12	7.29	16
1/8	1800	115	48Y	4404	5KH39QN5550X	√	\$201	F1	2.6	11	8.93	16
1/4	1800	115	48Y	HG716	5KH36DNA780X		\$441	F1	5.7	12	9.01	17
1/3	1800	115	48Y	HG717	5KH37GNA782X		\$472	F1	6.2	14	9.41	17

TRANSFORMER COOLING FAN REPLACEMENT MOTORS

TEAO, SINGLE SPEED, RIGID BASE MOTORS

FEATURES:

- External cooling air required
- Reversible rotation
- Ball bearings
- Optional extended clamp screws
- Z shaft is .50 x 2.25" with 1.91" Flat



HP	RPM	VOLTS	FRAME	CAT. NO.	MODEL NO.	STOCK	LIST PRICE	MULT. SYMB.	F.L. AMPS	WT.	"C" DIM.	FOOT NOTES
SINGLE-PHASE												
1/20	1625	115/200-230	48Z	PG240	5KCP35CNA490S	√	\$521	F1	1.5/07-0.8	12	10.32	9, 25, 50, 94, 113
1/3	1075	115/200-230	56Z	P241	5KCP36RNA491S	√	\$658	F1	4.4/2.1-2.2	21	10.75	9, 25, 50, 94, 113
THREE-PHASE												
1/3	1200	200-230/460	56	K1487	5K49MN6126T	√	\$923	F1	2.1-2.0/1.0	27	10.38	68, 113

ME-CAN-DO – MULTI-HORSEPOWER MOTORS

The new Marathon® “Me-Can-Do” line of motors is a multi-horsepower motor that replaces many different ratings.

HERE ARE SOME OF THE ADVANTAGES OF THE ME-CAN-DO MOTOR:

1. Saves money! Eliminates unnecessary inventory on shelves or in repair trucks.
2. Saves time! No more long drives for replacement motors. No more late hour or emergency shop openings.
3. This motor “Can Do” the job the first time! Offers multiple options in just one motor, no need for temporary substitutions.

ME-CAN-DO motors replace these motors today:

CONDENSER FAN MOTORS

MARATHON	CENTURY®
X072	FSE6000
X076	FE6002

DIRECT DRIVE FAN AND BLOWER MOTORS

MARATHON	CENTURY
X033	FDL6001
X073	FD6000
X074	FDL6002
X075	FD6001

ME-CAN-DO - MULTI-HORSEPOWER MOTORS

CONDENSER FAN, PSC, TEAO, THRU-BOLT MOTORS

APPLICATIONS:

Direct drive fans for shaft up or horizontal mount. These motors need to be mounted within the airflow of the fan for proper cooling.



FEATURES:

- Ball bearings
- 60°C ambient
- Automatic reset thermal protector
- Weather resistant reversing plug
- Reversible by reconnection
- 36" long leads
- Extended thru-bolts, 8-32 1/2" on drive end, 3/4" on non-drive end
- Shaft slinger
- Four locating screws on frame, 90° apart
- 1/2" x 5" long shaft with two flats 4.50" 90° apart
- UL recognized and CSA certified
- Capacitor not included, see accessories section

HP	RPM	VOLTS	FRAME	CAPACITOR (MFD)	SPEED RANGE	CAT. NO.	MODEL NO.	STOCK	LIST PRICE	MULT. SYMB.	F.L. AMPS	WT.	FRAME LENGTH
1/3		230		5.0	HI						2.3		
1/3		208		7.5	HI						2.3		
1/4		230		5.0	HI						2.0		
1/4		208		7.5	HI						2.0		
1/5	1075/2	230	48Y	5.0	LO	X072	48A11T646	√	\$304	F1	1.4	14	5 1/2
1/5		208		7.5	LO						1.4		
1/6		230		5.0	LO						1.2		
1/6		208		7.5	LO						1.2		
1/2		230		10.0	HI						2.5		
1/2		208		12.5	HI						2.6		
1/3		230		10.0	HI						2.1		
1/3		208		12.5	HI						2.0		
1/4	1075/2	230	48Y	10.0	LO	X076	48A11T11006	√	\$327	F1	1.4	19	5 1/2
1/4		208		12.5	LO						1.4		
1/5		230		10.0	LO						1.2		
1/5		208		12.5	LO						1.2		

ME-CAN-DO - MULTI-HORSEPOWER MOTORS

FAN & BLOWER - DIRECT DRIVE, PSC, OPEN AIR OVER RESILIENT RING, THRU-BOLT MOTORS

APPLICATIONS:

Residential and commercial furnaces, air conditioners, exhaust fans, and other air handling equipment installed in clean and dry environments.

FEATURES:

- Open end brackets
- 2 1/4" resilient rings
- 1/2" x 5" long shaft with two flats 4.50" 90° apart
- Automatic reset thermal protector
- Weather resistant reversing plug
- Reversible by reconnection
- 36" long leads
- Extended thru-bolts, 8-32 1/2" on drive end, 3/4" on non-drive end
- UL recognized and CSA certified
- Capacitor not included, see accessories section
- Ball bearings

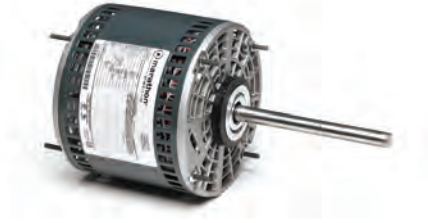

HP	RPM	VOLTS	FRAME	CAPACITOR (MFD)	SPEED RANGE	CAT. NO.	MODEL NO.	STOCK	LIST PRICE	MULT. SYMB.	FL. AMPS	WT.	FRAME LENGTH
1/2				10.0	ALL						6.1		
1/3				5.0	ALL						5.2		
1/3				7.5	ALL						4.7		
1/4				5.0	MED-HI						3.6		
1/4	1075/4	115	48Y	7.5	MED-LO, LO	X077	48A11O11066	√	\$231	F1	3.2	15	5
1/5				5.0	MED-LO						2.8		
1/5				7.5	LO						2.5		
1/6				5.0	LO						2.4		
1/6				7.5	LO						2.0		
1/2				10.0	ALL						2.7		
1/3				5.0	ALL						2.3		
1/3				7.5	ALL						2.1		
1/4				5.0	MED-HI					F1	1.6		
1/4	1075/4	208-230	48Y	7.5	MED-LO, LO	X073	48A11O11064	√	\$237		1.4	14	4 3/4
1/5				5.0	MED-LO						1.3		
1/5				7.5	LO						1.1		
1/6				5.0	LO						1.1		
1/6				7.5	LO						0.9		
3/4				20.0	ALL						7.8		
1/2				10.0	ALL						7.1		
1/3	1075/4	115	48Y	10.0	MED-HI, MED-LO, LO	X074	48A11O11042	√	\$276		4.9	22	6
1/4				10.0	MED-LO, LO						3.7		
1/5				10.0	LO						2.9		
3/4				20.0	HI						3.8		
1/2				20.0	MED-HI						2.7		
1/2				10.0	HI						3.7		
1/3				20.0	MED-LO						1.9		
1/3	1075/4	208-230	48Y	10.0	MED-HI	X075	48A11O11063	√	\$295		2.8	22	6
1/4				20.0	LO						1.4		
1/4				10.0	MED-LO						2.6		
1/5				10.0	LO						1.6		

OEM: BRAND C MOTORS

PSC, OPEN AIR OVER MOTORS

FEATURES:

- Ball bearings
- Multi-speed capability, as noted
- Resilient ring/belly band mount
- X203 replaces Fasco® No. D804 & Century® No. 655
- Capacitor not included, see accessories section

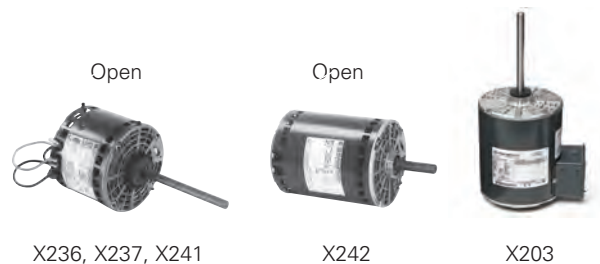

HP	RPM	VOLTS	FRAME	CAT. NO.	MODEL NO.	STOCK	LIST PRICE	MULT. SYMB.	FL. AMPS	WT.	FRAME LENGTH	SHAFT DIM.	FOOT NOTES
1/3	1075/4	115	48Y	X236	048A11O699	√	\$276	F1	6.4	16	4 3/4	1/2 x 6	
	1075/4	208-230	48Y	X237	048A11O694		\$281	F1	4.8	16	5 1/4	1/2 x 6	
1/2	1075	208-230	48Y	X203	048A11O1062	√	\$344	F1	5.3	19	6 1/2	1/2 x 5 1/2	16
3/4	1075/4	208-230	48Y	X241	048A11O697	√	\$355	F1	5.4	17	5 1/2	1/2 x 6	
1	1000/3	208-230	48YZ	X242	048A11O756	√	\$601	F1	6.2	26	7 1/4	5/8 x 4	51, 68

Replacements listed may not be an exact duplicate of the original motor.

OEM REPLACEMENTS

OEM: BRAND C MOTORS

PSC, OPEN AIR OVER MOTORS

FEATURES:

- Single and multi-speed models, as noted
- 3 lug mounting
- X223 replaces Fasco No. D842
- X273 Fasco No. D844, Century No. OCA1024 & Century No. 624
- X210 replaces Century No. 514, & Century No. OCB1026
- X222 replaces Century No. 536 & Century No. OCB1036
- X405 replaces Century No. OCA1056
- Ball bearings (except as noted)
- Capacitor not included, see accessories section

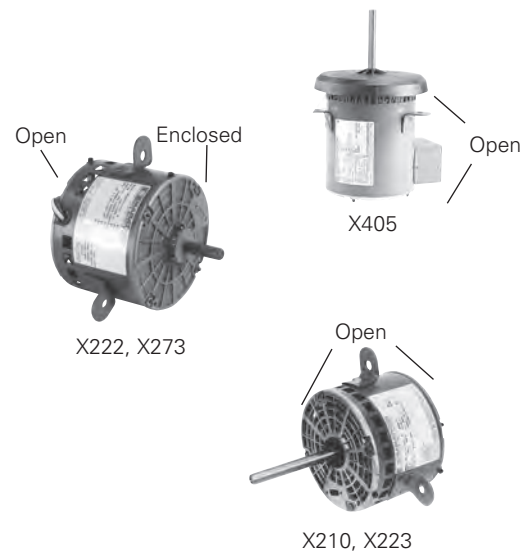

HP	RPM	VOLTS	FRAME	CAT. NO.	MODEL NO.	STOCK	LIST PRICE	MULT. SYMB.	FL. AMPS	WT.	FRAME LENGTH	SHAFT DIM.	FOOT NOTES
1/5	1075/1	230	48Y	X223	048A11O2050		\$233	F1	1.3	10	3 3/4	1/2 x 2 3/4	16
1/4	1625/1	230	48Y	X273	048A17O161		\$218	F1	1.5	12	4 1/4	1/2 x 1 5/8	16
	1075/2	208-230	48Y	X210	048A11O1068	√	\$233	F1	2.2	13	4 1/8	1/2 x 4 1/4	
1/3	1075/2	230	48Y	X222	048A11O1109	√	\$290	F1	2.6	15	4 3/4	1/2 x 3	
1/2	1075/1	208-230/460	48Y	X405	048A11O1744	√	\$378	F1	3.6/1.8	25	6 7/8	1/2 x 4	21

OEM: BRAND C MOTORS

THREE PHASE, OPEN AIR OVER MOTORS

FEATURES:

- Ball bearings
- X235 is 70° C ambient

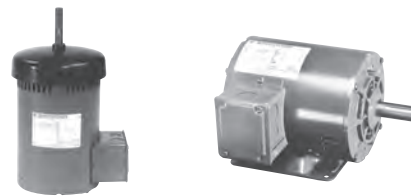

HP	RPM	VOLTS	FRAME	CAT. NO.	MODEL NO.	STOCK	LIST PRICE	MULT. SYMB.	F.L. AMPS	WT.	FRAME LENGTH	SHAFT DIM.	FOOT NOTES
1	1140	200-230/460	56Y	X235	056T11D5209	√	\$747	F1	6.6-6.0/3.0	36	10.50	5/8 x 2 7/8	
5	3600	208-230/460	56HZ	X251	056T34D5364	√	\$1,042	F1	13.5-12.4/6.2	50	13.49	7/8 x 2 1/4	Z, 5

Replacements listed may not be an exact duplicate of the original motor.

OEM: BRAND C/BDP MOTORS

THREE PHASE MOTORS

FEATURES:

- Ball bearings
- H978V1 is rated for 70° C ambient
- FB3154 Century No. P56A01A02
- H978V1 replaces Century EMI No. 176055
- H980L replaces Century EMI No. 182779
- H979L replaces Century EMI No. 182779



HP	RPM	VOLTS	FRAME	CAT. NO.	MODEL NO.	STOCK	LIST PRICE	MULT. SYMB.	F.L. AMPS	WT.	FRAME LENGTH	SHAFT DIM.	ENCLOSURE
SPL	1725	208-230/460	56	FB3154	Century®	√	\$738	F1	3.6/1.8	26	9 7/8	5/8 x 2	Open
SPL	1140	208-230/460/575	56Z	H978V1	Century	√	\$1,530	F1	5.5/2.8-3.4	44	11 3/8	5/8 x 3 5/8	OAO
3	1725	208-230/460	56Y	H980L	Century	√	\$1,650	F1	9.0-9.0/4.5	45	12 5/8	7/8 x 2 5/16	ODP
5	1725	208-230/460	56Y	H979L	Century	√	\$2,051	F1	14.5-14.4/7.2	52	13 5/8	7/8 x 2 5/16	ODP

Replacements listed may not be an exact duplicate of the original motor

OEM: EVANS / ARMSTRONG / LSI HOME MOTORS

PSC, OPEN AIR OVER MOTORS

FEATURES:

- Resilient ring thru-bolt mounting
- Replaces Fasco No, D825
- Ball bearings
- Capacitor not included, see accessories section

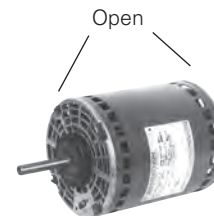

HP	RPM	VOLTS	FRAME	CAT. NO.	MODEL NO.	STOCK	LIST PRICE	MULT. SYMB.	F.L. AMPS	WT.	FRAME LENGTH	SHAFT DIM.	FOOT NOTES
1	1625/2	208-230	48Y	X211	048A17O125	√	\$395	F1	6.2	20	6 1/4	1/2 x 2 1/2	

The following are not owned or controlled by Regal Beloit Corporation. LSI is believed to be the trademark or trade name of Nortek Global HVAC, LLC

Prices and specifications are subject to change without notice.

OEM: GREENHECK® FAN MOTORS

PSC, OPEN AIR OVER MOTORS

FEATURES:

- Thru-bolt mounting
- Automatic reset thermal protector
- Internal cooling fan
- X261 replaces Greenheck No. 300008
- X260 replaces Greenheck No. 300010
- Ball bearings
- Capacitor included



HP	RPM	VOLTS	FRAME	CAT. NO.	MODEL NO.	STOCK	LIST PRICE	MULT. SYMB.	F.L. AMPS	WT.	FRAME LENGTH	SHAFT DIM.	FOOT NOTES
1/8	825	115	48Y	X261	048A8O151	√	\$311	F1	2.1	13	5 1/2	1/2 x 2 1/2	
1/6	1140	115	48Y	X260	048A11O251	√	\$295	F1	2.2	13	5 1/4	1/2 x 2 1/2	

Replacements listed may not be an exact duplicate of the original motor.

OEM: HILL® REFRIGERATION MOTORS

PSC, OPEN AIR OVER MOTORS

FEATURES:

- Resilient base
- Replaces Century No. 160
- Fasco No. D801
- Ball bearings
- Capacitor included

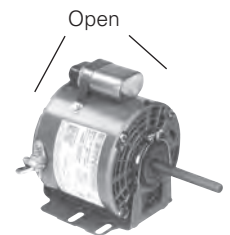

HP	RPM	VOLTS	FRAME	CAT. NO.	MODEL NO.	STOCK	LIST PRICE	MULT. SYMB.	F.L. AMPS	WT.	FRAME LENGTH	SHAFT DIM.	FOOT NOTES
1/3	1625	208-230	48Y	X230	048A17O136	√	\$288	F1	1.8	14	4 3/4	1/2 x 3 1/2	15

OEM REPLACEMENTS

OEM: HUEBSCH® MOTORS

SINGLE PHASE, DRIPPROOF, RESILIENT BASE MOTORS

APPLICATIONS:

Commercial laundry dryer motors.

FEATURES:

- Replaces Huebsch commercial laundry dryer motors
- Automatic reset thermal protection
- Special threaded shaft extension
- X602 has 3/4" shaft adapter included
- Ball bearings
- 48YZ have 48/56 Fr. mounting holes



HP	RPM	VOLTS	FRAME	CAT. NO.	MODEL NO.	STOCK	LIST PRICE	MULT. SYMB.	F.L. AMPS	WT.	"C" DIM.	FOOT NOTES
1/4	1725	100-120/200-240	48YZ	X600	048C17D2057		\$381	F1	5.4-6.6/2.7-3.3	18	12.02	16, 68
1/3	1725	115/208-230	56Z	X601	056C17D2101	√	\$451	F1	5.8/2.8-2.9	20	14.41	16
1/2	1725	115/208-230	56Z	X602	056C17D2102	√	\$555	F1	8.0/4.0-4.0	24	15.41	16
3/4	1725	115/208-230	56Z	X603	056C17D5346	√	\$700	F1	12.0/5.8-6.0	29	15.10	16

OEM: HUSSMAN REFRIGERATION MOTORS

PSC, OPEN AIR OVER MOTORS

FEATURES:

- Thru-bolt mounting
- Replaces Fasco No. D807, Century No. 174
- Ball bearings
- Capacitor included

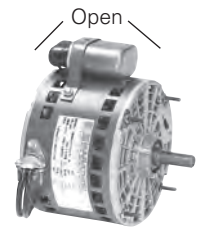

HP	RPM	VOLTS	FRAME	CAT. NO.	MODEL NO.	STOCK	LIST PRICE	MULT. SYMB.	F.L. AMPS	WT.	FRAME LENGTH	SHAFT DIM.	FOOT NOTES
1/6	1625	208-230	48Y	X269	048A17O147	√	\$320	F1	1.2	11	4 1/8	1/2 x 1 1/2	15

OEM: LIEBERT MOTORS

THREE PHASE, RESILIENT BASE MOTORS

FEATURES:

- Ball bearings

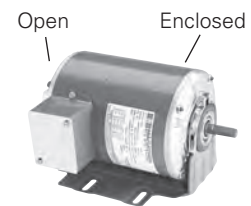

HP	RPM	VOLTS	FRAME	CAT. NO.	MODEL NO.	STOCK	LIST PRICE	MULT. SYMB.	F.L. AMPS	WT.	FRAME LENGTH	SHAFT DIM.	FOOT NOTES
1/3	1140	208-230/460	48Y	X259	056T11O15	√	\$397	F1	1.9-1.8/9	29	10.06	1/2 x 1 1/2	

Replacements listed may not be an exact duplicate of the original motor.

The following are not owned or controlled by Regal Beloit Corporation. Hussman is believed to be a trade name of Hussman Refrigeration, Bolingbrook, IL. Liebert is believed to be a tradename of Liebert Corporation, Columbus, OH. Huebsch is a trademark of Alliance Laundry Systems LLC Limited Liability Company.

Prices and specifications are subject to change without notice.

OEM: BRAND L MOTORS

PSC, TOTALLY ENCLOSED & OPEN AIR OVER MOTORS

FEATURES:

- X411 replaces Brand L No. 47F9901, Century No. 9402, & Marathon Nos. 48A11T300 & 48A11T247
- X209 replaces Fasco® No. D2817 open/air over
- X236 replaces Brand L P-8-7505, Century No. 565, Century No. OLE1036, & Fasco No. D812, open/air over
- X281 replaces Brand L No. P-8-2702, Fasco No. D814, open/air over
- Ball bearings
- Capacitor not included, see accessories section

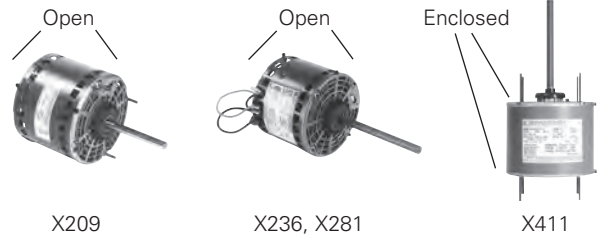

HP	RPM	VOLTS	FRAME	CAT. NO.	MODEL NO.	STOCK	LIST PRICE	MULT. SYMB.	F.L. AMPS	WT.	FRAME LENGTH	SHAFT DIM.	FOOT NOTES
1/6	1075/1	208-230	48Y	X411	048A11T2008	√	\$242	F1	1.3	10	3 3/4	1/2 x 6	
1/3	825/1	230	48Y	X209	048A8O183	√	\$303	F1	3	17	5 3/4	1/2 x 5 1/2	34, 50
	1075/4	115	48Y	X236	048A11O699	√	\$276	F1	6.4	16	4 3/4	1/2 x 6	39

OEM: BRAND R MOTORS

PSC, TOTALLY ENCLOSED & OPEN AIR OVER MOTORS

FEATURES:

- X278 Replaces Brand R Nos. 21276-02, 21276-01, 51207-01 & Fasco No. D832
- X216 Replaces Century No. 619
- X470 Replaces Brand R condenser fans
- X297 Replaces Century No. ORM1036, Century 620, & Fasco No. D2834
- Ball bearings
- Capacitor not included, see accessories section

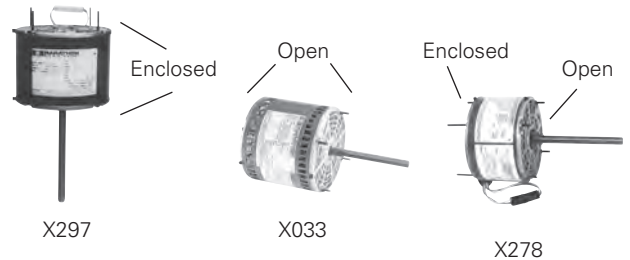

HP	RPM	VOLTS	FRAME	CAT. NO.	MODEL NO.	STOCK	LIST PRICE	MULT. SYMB.	F.L. AMPS	WT.	FRAME LENGTH	SHAFT DIM.	FOOT NOTES
1/8	825/1	208-230	48Y	X278	048A8O206	√	\$288	F1	0.9	4 1/4	11	1/2 x 4 3/4	37, 44
1/5	1075/1	208-230	48Y	X216	048A11O1097	√	\$212	F1	1.6	3 3/4	10	1/2 x 6	37, 44, 60
1/4	1075/1	208-230	48Y	X470	048A11O885	√	\$223	F1	1.6	3 3/4	9	1/2 x 3	56, 60
1/3	1075/1	208-230	48Y	X297	048A11T509	√	\$225	F1	1.8	4 1/4	12	1/2 x 3 3/4	N, 29, 41, 60
1/2	1075/4	115	48Y	X033	048A11O1674	√	\$231	F1	6.1	5	15	1/2 x 5	31

Replacements listed may not be an exact duplicate of the original motor.

OEM: BRAND S / BRAND W MOTORS

PSC, OPEN AIR OVER MOTORS

FEATURES:

- X215 replaces Brand D inside out window a/c, Fasco No. D857, Century No. OWL1006
- X212 replaces Brand D inside out window a/c, Fasco No. D858, & Century No. OWR1016
- X200 replaces Brand D inside out window a/c, Fasco No. D859, & Century No. OWR1036
- X218 replaces Steveco® Package unit 3100
- Single split phase, open air over
- Capacitor not included, see accessories section

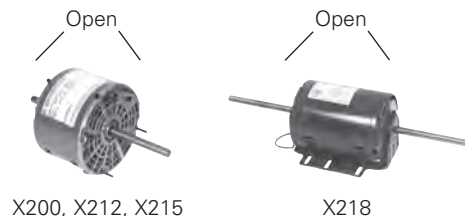

HP	RPM	VOLTS	FRAME	CAT. NO.	MODEL NO.	STOCK	LIST PRICE	MULT. SYMB.	F.L. AMPS	WT.	FRAME LENGTH	SHAFT DIM.	FOOT NOTES
1/8	1100/3	115	48Y	X215	048A11O1081		\$231	F1	1.7	10	3 7/8	4 x 1/2 x 2 3/4	4, 16
1/6	1100/3	230	48Y	X212	048A11O1065		\$231	F1	1.1	11	3 7/8	4 x 1/2 x 2 3/4	16
1/3	1100/3	230	48Y	X200	048A11O1060		\$234	F1	1.7	12	4 1/3	6 x 1/2 x 4	4, 16
3/4	1075/1	208-230	56Z	X218	056A11O5313	√	\$614	F1	3.9-3.6	34	8 5/8	7 x 5/8 x 7	16, 21

OEM: TACO MOTORS

SINGLE SPLIT PHASE, OPEN AIR OVER MOTORS

FEATURES:

- Resilient ring mounting
- 4722 replaces Taco No. 110-388, Marathon No. 48S17D1027, 48S17D2102
- 4404 replaces Marathon No. 48S17D1084
- UL recognized and CSA certified

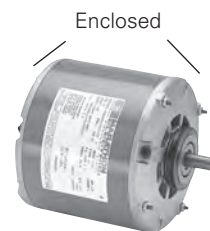

HP	RPM	VOLTS	FRAME	CAT. NO.	MODEL NO.	STOCK	LIST PRICE	MULT. SYMB.	F.L. AMPS	WT.	"C" DIM.	SHAFT DIM.	FOOT NOTES
1/12	1800	115	48Y	4722	5KH39QN5558T	√	\$185	F1	2.1	12	7.29	1/2 x 1	16
1/8	1800	115	48Y	4404	5KH39QN5550X	√	\$201	F1	2.6	11	8.93	1/2 x 1 1/2	16

OEM: TYLER MOTORS

PSC, OPEN AIR OVER MOTORS

FEATURES:

- Resilient ring thru-bolt mounting
- Replaces Tyler No. 760, Fasco No. D870, & Century No. OTY1024
- Ball bearings
- Capacitor included

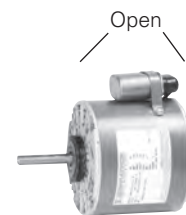

HP	RPM	VOLTS	FRAME	CAT. NO.	MODEL NO.	STOCK	LIST PRICE	MULT. SYMB.	F.L. AMPS	WT.	FRAME LENGTH	SHAFT DIM.	FOOT NOTES
1/4	1625/1	208-230	48Y	X270	048A17O149	√	\$344	F1	1.9	12	4 3/4	1/2 x 2 1/2	16

Replacements listed may not be an exact duplicate of the original motor.

The following are not owned or controlled by Regal Beloit Corporation. Steveco is believed to be the trademark or trade name of Emerson Electric Co.

OEM: BRAND W MOTORS

PSC, OPEN AIR OVER MOTORS

FEATURES:

- Resilient ring mounting
- Ball bearings
- Capacitor included

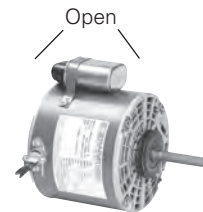

HP	RPM	VOLTS	FRAME	CAT. NO.	MODEL NO.	STOCK	LIST PRICE	MULT. SYMB.	F.L. AMPS	WT.	FRAME LENGTH	SHAFT DIM.	FOOT NOTES
1/3	1075/1	208-230	48Y	X268	048A11O1239	√	\$352	F1	3.0	14	4 3/4	1/2 x 2 7/8	15

OEM: BRAND Y MOTORS

PSC, OPEN AIR OVER MOTORS

FEATURES:

- Round belly band mounting
- Replaces Brand Y No. K44HXJAF-4955 & Fasco No. D873, Century No. OYK1056, Century No. 468
- Ball bearings
- Capacitor not included, see accessories section

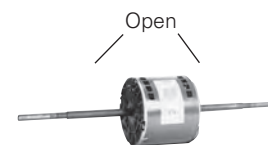

HP	RPM	VOLTS	FRAME	CAT. NO.	MODEL NO.	STOCK	LIST PRICE	MULT. SYMB.	F.L. AMPS	WT.	FRAME LENGTH	SHAFT DIM.	FOOT NOTES
1/2	1050	230	48Y	X295	048A11O1410	√	\$314	F1	3.9	19	5	9 1/4 x 1/2 x 9 1/8	15

Replacements listed may not be an exact duplicate of the original motor.

PEDESTAL FAN, PSC, TEAO MOTORS

48 FRAME, YOKE MOUNT MOTORS

FEATURES:

- Heavy gauge steel frame and yoke fan shroud mounted by four 7/8" extended stud bolts on 5-1/8" bolt circle
- Single and multi-speed models, as noted
- Automatic reset thermal protector
- 1/2" x 2-1/2" long shaft with two flats, 90° apart
- 1.0 Service factor
- Ball bearings (except as noted)
- Capacitor included
- UL recognized and CSA certified



HP	RPM	VOLTS	FRAME	CAT. NO.	MODEL NO.	STOCK	LIST PRICE	MULT. SYMB.	F.L. AMPS	FRAME LENGTH	WT.	"C" DIM.	FOOT NOTES
1/4	1625/1	115/230	48Z	X920	048A17T2005	√	\$324	F1	3.6/1.8	7.3	22	10.56	
	1075/2	115	48Z	X923	048A11T2024	√	\$378	F1	3.2	6.5	18	9.81	
1/3	1625/1	115/230	48Z	X921	048A17T2006	√	\$352	F1	3.8/1.9	7.8	24	11.06	
	1075/2	115	48Z	X924	048A11T2025	√	\$408	F1	4.2	6.5	19	9.81	
1/2	1625/1	115/230	48Z	X922	048A17T2007	√	\$389	F1	5.4/2.7	8.0	27	11.31	
	1075/2	115	48Z	X925	048A11T2026	√	\$454	F1	5.7	7.5	25	10.81	

PEDESTAL FAN MOTORS

48 FRAME, YOKE MOUNT MOTORS

FEATURES:

- Continuous duty
- 1.0 Service factor
- Sleeve bearings
- Thermally protected
- PSC & split phase designs
- Capacitor included on PSC models



HP	RPM	VOLTS	FRAME	CAT. NO.	MODEL NO.	STOCK	LIST PRICE	MULT. SYMB.	FL. AMPS	ENCLOSURE	WT.	"C" DIM.	FOOT NOTES
1/4	1725	115	48YZ	YA2020	Century®	√	\$410	F1	4.2	TEAO	14	9.80	3, 34
	1725	115	48	914L	Century	√	\$390	F1	5.1	ODP	13	9.90	3
1/3	1725	115	48YZ	YA2030	Century	√	\$420	F1	6.0	Enclosed	15	10.30	3, 34
1/2	1725	115	48	915L	Century	√	\$511	F1	6.9	ODP	17	10.30	3
	1725	115	48YZ	YA2054	Century	√	\$539	F1	5.0	Enclosed	21	10.80	74

NESBITT REPLACEMENT MOTORS, PSC

RESILIENT BASE

FEATURES:

- Single speed except for C032A its 3 speeds
- 1.0 service factor
- Ball bearings (except as noted)
- Capacitor included
- TEAO except C032A is OAO and C033 is ODP



HP	RPM	VOLTS	FRAME	CAT. NO.	MODEL NO.	STOCK	LIST PRICE	MULT. SYMB.	FL. AMPS	SHAFT DIA. & LENGTH	WT.	PROTECTOR	FOOT NOTES
1/12	715	115	56Z	C031	Century	√	\$1,436	F1	2.0	16-5/8 x 3/4 x 16-5/8	40	None	
1/8	850	115	48Y	C032A	Century	√	\$1,110	F1	1.5	6-1/2 x 1/2 x 6-1/2	16	Auto	4, 15
1/6	800	230	56Z	C035	Century	√	\$1,578	F1	1.6	20-3/4 x 3/4 x 20-1/2	45	Auto	15
	800	115	56Z	C034	Century	√	\$1,436	F1	3.0	21-1/2 x 3/4 x 21-1/2	45	Auto	15
	800	115	56	C033	Century	√	\$1,088	F1	3.0	5/8 x 2	27	Auto	
1/3	850	115	56Z	C036	Century	√	\$1,578	F1	5.0	23 x 3/4 x 23	53	Auto	

AGGREGATE DUTY - BLUE CHIP SERIES® CRUSHER MOTORS

NEMA PREMIUM® XRI® MOTOR

TOTALLY ENCLOSED, THREE PHASE, RIGID BASE, HIGH TORQUE MOTORS

APPLICATIONS:

Specifically designed for the aggregate industry crusher applications such as cone, jaw, and roller type impactors, pulverizers, etc.

FEATURES:

- Meets or exceeds NEMA Premium efficiencies
- Blue Chip Series® quality, 100% cast iron construction for rigidity and reduced vibration
- 4140 high strength shaft material
- NEMA® design C, extra high starting and breakdown torque design
- Roller bearing on drive end for belted loads
- IP55 rating, enclosure protection against dust and water jets
- Suitable for use on a VFD. 10:1 variable torque and 10:1 constant torque
- 1.15 service factor on sinewave, 1.0 service factor on IGBT power
- Suitable for across the line, wye-delta, part winding, or inverter start
- 80°C rise at rated load
- Class F insulation
- Axial surface seal (50 to 200HP) and Inpro® smart ring plus on the 250HP model, rotating shaft seals on each end
- External epoxy paint
- Brass drain and breather
- UL recognized, CSA certified, and CE mark



HP	RPM	VOLTS	FRAME	CAT. NO.	MODEL NO.	STOCK	LIST PRICE	MULT. SYMB.	NOM. EFF.	FL. AMPS	WT.	"C" DIM.	FOOT NOTES
50	1800	230/460	326T	Y818A	326TTFC6633	√	\$6,569	E4	94.5	116.0/58.0	875	33.86	YD
	1200	230/460	365T	Y840A	365TTFC6683	√	\$11,451	E4	94.1	120.0/60.0	1067	38.39	YD
60	1800	230/460	364T	Y819A	364TTFC6633	√	\$9,475	E4	95.0	138.0/69.0	1000	36.61	YD
	1200	230/460	404T	Y850A	404TTFC6683	√	\$12,677	E4	94.5	144.0/72.0	1340	42.72	YD
75	1800	230/460	365T	Y820A	365TTFC6633	√	\$11,705	E4	95.4	172.0/86.0	1235	38.39	YD
	1200	230/460	405T	Y852A	405TTFC6683	√	\$14,857	E4	94.5	178.0/89.0	1455	42.72	YD
100	1800	230/460	405T	Y822B	405TTFC6633	√	\$14,664	E4	95.4	228.0/114.0	1463	42.72	YD
	1200	460	444T	Y851A	444TTFC6683	√	\$21,975	E4	95.0	114.0	2061	50.79	YD
125	1800	460	444T	Y824A	444TTFC6633	√	\$19,906	E4	95.4	140.0	1980	50.79	YD
	1200	460	445T	Y853A	445TTFC6683	√	\$24,609	E4	95.0	142.0	2155	50.79	YD
150	1800	460	445T	Y826A	445TTFN14571	√	\$20,207	E4	95.0	174.0	1990	43.35	d, YD
	1800	460	445T	Y826B	445TTFC6633	√	\$21,823	E4	95.8	165.0	2140	50.79	YD
	1200	460	447T	Y854A	447TTFC6683	√	\$30,345	E4	95.8	170.0	2543	55.91	YD
200	1800	460	447T	Y828A	447TTFC6633	√	\$26,933	E4	96.2	225.0	2175	55.91	YD
	1200	460	447/449T	Y855B	449TTFC6683	√	\$32,591	E4	95.8	228.0	2610	55.91	YD
250	1800	460	447/449T	Y856A	449TTFS36633	√	\$30,028	E4	96.5	282.0	2924	51.84	YD

Catalog numbers (Cat No.) highlighted in bold blue are premium efficient.

Blue shaded areas are cast iron frames.

Inpro is believed to be the trademark or trade name of Inpro/Seal LLC and is not owned or controlled by Regal Beloit Corporation.
NEMA and NEMA Premium are trademarks of National Electrical Manufacturers Association. All Rights Reserved.

Prices and specifications are subject to change without notice.

AIR COMPRESSOR, SINGLE PHASE MOTORS

DRIPPROOF, RIGID BASE MOTORS

FEATURES:

- Capacitor start/capacitor run design for low amps and high efficiency, as noted
- High starting and breakdown torque
- Heavy gauge steel frame and base
- Continuous duty at nameplate ratings
- Thermal protection, as noted
- UL recognized and CSA certified



HP	RPM	VOLTS	FRAME	OVER LOAD	CAT. NO.	MODEL NO.	STOCK	LIST PRICE	MULT. SYMB.	FL. AMPS	WT.	"C" DIM.	FOOT NOTES
1/2	3600	115	56	MANUAL	9031	5KC49MN2043Y	✓	\$343	F1	11.5	20	11.14	2, 17
	3600	115/230	56	MANUAL	B685	Century®	✓	\$477	F1	9.6/4.8	18	11.0	d, 15
1/3	1800	115/230	56	MANUAL	C169	5KC49GN0010Y	✓	\$453	F1	8.8/4.4	21	10.38	2
	3600	115	56	MANUAL	9032	5KC49MN2049Y	✓	\$398	F1	12.5	27	11.14	2, 17
3/4	3600	115/230	56	MANUAL	CP1072L	Century	✓	\$520	F1	12.5/6.75	24	10.60	2
	1800	115/208-230	56	MANUAL	K016	56B17D56	✓	\$555	F1	11.0/5.5	25	11.47	1
	1800	115/230	56	NONE	C639	Century	✓	\$615	F1	10.0/5.0	27	11.10	2
1	3600	115/230	56	MANUAL	9033	5KC49NN2050Y	✓	\$454	F1	16.0/8.0	23	11.14	d, 2, 17
	3600	115/208-230	56	MANUAL	D010	56B34D2029	✓	\$457	F1	10.6/5.5-5.3	23	11.72	1
	3600	115/230	56	MANUAL	CP1102L	Century	✓	\$577	F1	12.0/6.0	26	11.40	2
	1800	115/208-230	56	MANUAL	C1480	5KC49PN0161Y	✓	\$604	F1	13.6/6.8	31	11.38	2
1 1/2	3600	115/208-230	56	MANUAL	C704	5KC49PN2521Y	✓	\$588	F1	21.3/10.6	31	11.91	2, 18
	3600	115/230	56	MANUAL	CP1152L	Century	✓	\$602	F1	12.5/6.3	32	11.90	1, 48
	1800	115/208-230	56H	MANUAL	G951	56C17D5308	✓	\$706	F1	18.0/9.3-9.0	39	12.44	2, 5, 7
2	3600	115/208-230	56H	MANUAL	9035	5KCR48TN2650Y	✓	\$736	F1	15.0/7.5	38	11.14	ES, 1, 17, 48
	3600	115/230	56	MANUAL	CP1202L	Century	✓	\$736	F1	24.0/12.0	33	12.70	2, 57, 48
	1800	115/208-230	145T	MANUAL	I127	145TBDR5337	✓	\$851	F1	18.8/10.2-9.4	48	13.49	1, 7
3	3600	230	56H	MANUAL	9036	5KCR48UN2653Y	✓	\$959	F1	15.0	40	11.44	ES, 1, 17, 48
	3600	208-230	56	MANUAL	CP1302L	Century	✓	\$959	F1	13.1-12.3	33	12.70	1
	1800	230	184T	NONE	Z502	184TBDR5326	✓	\$891	S1	12.6	51	14.27	1
	1800	115/230	184T	NONE	V201M2	Century	✓	\$1,477	S1	34.0/17.0	78	14.70	2, 16, 18
SPCL	3600	230	56	MANUAL	9040	5KCR48UN2654Y	✓	\$864	F1	15.0	40	12.10	ES, 1
SPCL	3600	230	56H	MANUAL	CP1502LV1	Century	✓	\$864	F1	15.0	38	12.80	1
5	3600	208-230	56Y	MANUAL	B384	Century	✓	\$1,027	F1	22.0	50	14.60	1, 15, 18, 125
	3600	230	56H	MANUAL	9038B	5KCR49ZN2722Y	✓	\$1,020	F1	21.0	49	15.04	ES, 1, 5, 17, 48
	3600	230	56H	MANUAL	D017	56B34D5302	✓	\$1,020	F1	20.0	55	13.94	1, 5
	3600	208-230	56HZ	MANUAL	D019	056B34D15532	✓	\$1,020	F1	22.0	47	14.60	1, 15, 18
	3600	230	56HZ	MANUAL	CP1502L	Century	✓	\$1,020	F1	19.7	44	14.10	1, 48, Z
	3600	230	56HZ	MANUAL	B813	Century	✓	\$1,020	F1	22.0	45	14.10	1, 15
	3600	208-230	56HZ	MANUAL	B386	Century	✓	\$1,020	F1	22.0	47	14.60	1, 15, 18
	3600	230	184T	NONE	Z504	184TBDR5301	✓	\$1,251	S1	20.0	62	14.77	1
	3600	230	184T	NONE	V211M2	Century	✓	\$1,492	S1	25.6	82	14.70	2, 16, 18
	1800	208-230	184T	MANUAL	I119	184TBDR7375	✓	\$1,420	S1	25.0-24.1	83	16.22	1, 13
	1800	230	184T	NONE	V208M2	Century	✓	\$1,455	S1	22.0	84	15.00	1, 16, 18
	1800	208-230	184T	NONE	I114A	184TBDW7026	✓	\$1,093	S1	23.0-21.0	82	14.69	1, 13
1800	208-230	184T	NONE	Z506A	184TBDW7656	✓	\$1,071	S1	22.0-20.0	81	15.21	1, 13	
6	3600	230	56Y	MANUAL	B387	Century	✓	\$1,258	F1	24.0	53	14.60	1, 15, 132
7 1/2	3600	208-230	184T	NONE	I108A	184TBDW7001	✓	\$1,227	S1	34.0-31.0	103	16.69	1, 13
	3600	208-230	213T	NONE	I105	213TCDW7001	✓	\$1,659	S1	40.0-37.0	102	16.55	2, F
	1800	208-230	215T	NONE	I115	215TBDW7026	✓	\$1,637	S1	37.2-34.5	115	18.05	1
10	1800	208-230	215T	NONE	I116	215TBDW7028	✓	\$2,107	S1	49.0-44.0	140	19.30	1

DEFINITE PURPOSE

AIR COMPRESSOR OEM SPECIAL REPLACEMENT MOTORS, SINGLE PHASE

DRIPPROOF, RIGID BASE MOTORS

FEATURES:

- Capacitor start/capacitor run design for low amps and high efficiency
- Heavy gauge steel frame and base
- 1.0 service factor
- Manual thermal protection
- CW rotation facing opposites shaft end



HP	RPM	VOLTS	FRAME	OVER LOAD	CAT. NO.	MODEL NO.	STOCK	LIST PRICE	MULT. SYMB.	FL. AMPS	WT.	"C" DIM.	FOOT NOTES
2 SPL	3600	115/230	56	MANUAL	B381	Century®	√	\$736	F1	15.0/7.5	27	11.3	
3 SPL	3600	115/230	56	MANUAL	B383	Century	√	\$642	F1	15.0/7.5	30	11.6	
5 SPL	3600	208-230	56	MANUAL	B385	Century	√	\$1,020	F1	15.0	37	12.6	

COOLING TOWER, TWO-SPEED-ONE WINDING, VARIABLE TORQUE MOTORS

BLUE CHIP SERIES® SEVERE DUTY, XRI® MOTOR

THREE PHASE, TOTALLY ENCLOSED, RIGID BASE MOTORS

APPLICATIONS:

Cooling towers, fan and blowers, and other severe duty environments where long life and ultra-high efficiency are desired. Guaranteed efficiencies offer an eXtra Return on your Investment when using these premium efficiency motors on high cycle or long run applications. Replacement for two-speed Marley® cooling tower motors.



IP55

FEATURES:

- Blue Chip Series quality, 100% cast iron construction for rigidity and reduced vibration
- Internal and external epoxy paint
- Class F insulation
- 1.15 service factor
- Extended grease tubes, regreasable in service
- T-drains provided for effective drainage (Installed in both endshields)
- Shaft slinger
- Forsheda® seals on both ends
- Actual test and vibration data supplied with each motor
- Ball bearings
- UL recognized and CSA certified
- Three year warranty
- Horizontal mounting only; consult engineering for vertical mounting

HP	RPM	VOLTS	FRAME	CAT. NO.	MODEL NO.	STOCK	LIST PRICE	MULT. SYMB.	NOM. EFF.	FL. AMPS	WT.	"C" DIM.	FOOT NOTES
3/7.5	1800/900	460	184T	Y380	184TTFS7290		\$2,206	S3	85.5	4.0/1.75	141	16.19	
5/1.25	1800/900	460	213T	Y381	213TTFS7238		\$2,438	S3	89.5	6.0/2.4	199	19.72	
7.5/1.9	1800/900	460	215T	Y382	215TTFS7290	√	\$3,160	S3	89.5	9.0/3.1	217	19.72	
10/2.5	1800/900	460	254T	Y383	254TTFNA7210		\$3,809	S3	90.2	12.0/4.0	360	23.65	
15/3.75	1800/900	460	256T	Y384	256TTFNA7250	√	\$4,757	S3	90.2	18.0/6.0	381	25.40	
20/5	1800/900	460	284T	Y385	284TTFNA7240	√	\$5,937	S3	91.7	24.0/8.5	489	26.21	
25/6.25	1800/900	460	286T	Y386	286TTFNA7260	√	\$6,928	S3	91.7	31.0/11.0	468	27.71	
30/7.5	1800/900	460	324T	Y387	324TTFS7290	√	\$8,455	S3	91.0	35.0/11.2	668	28.88	
40/10	1800/900	460	326T	Y388	326TTFS9210	√	\$10,567	S3	91.0	46.0/14.6	751	30.38	
50/12.5	1800/900	460	364T	Y389	364TTFS9234	√	\$13,439	S3	92.4	61.0/24.0	975	31.50	
60/15	1800/900	460	365T	Y390	365TTFS9230	√	\$19,450	S3	92.4	75.0/25.0	1000	32.50	
75/18.75	1800/900	460	405T	Y391	405TTFS7297		\$25,159	S3	94.1	83.0/27.0	1331	37.14	
100/25	1800/900	460	444T	Y392	444TTFS7262		\$30,429	S3	94.1	113.0/37.5	1781	41.27	

Blue shaded areas are cast iron frames.

Marley is believed to be the trademark or trade name of SPX Cooling Technologies and is not owned or controlled by Regal Beloit Corporation.

Forsheda is believed to be the trademark or trade name of Trelleborg Forsheda Sweden AB and is not owned or controlled by Regal Beloit Corporation.

Prices and specifications are subject to change without notice.

MULTI-SPEED: TWO-SPEED, ONE-WINDING, VARIABLE TORQUE MOTORS

THREE PHASE, DRIPPROOF, RIGID BASE MOTORS

APPLICATIONS:

Commercial and industrial fans, blowers, pumps, and other machinery that have variable torque characteristics. Prolonged use at low speed can result in significant energy savings. Drip-proof motors are intended for use in environments that are relatively clean and dry. For use outdoors an enclosure or drip cover may be required (see accessories section).



FEATURES:

- Ball bearings
- 1.15 service factor
- UL recognized and CSA certified

HP	RPM	VOLTS	FRAME	CAT. NO.	MODEL NO.	STOCK	LIST PRICE	MULT. SYMB.	NOM. EFF.	FL. AMPS	WT.	"C" DIM.	FOOT NOTES
3/7.5	1800/900	200-230	182T	Y1484	182TTDW7412	√	\$1,038	S3	84.5	9-8.2	65	13.19	F, 13
	1800/900	460	182T	Y485A	182TTDW7203		\$1,038	S3	84.5	4.1	58	13.19	13, 25
5/1.25	1800/900	200-230	184T	Y486A	184TTDW7287	√	\$1,454	S3	85.5	14.5-13.8	80	14.19	F, 13
	1800/900	460	184T	Y1487	184TTDW7209	√	\$1,454	S3	85.5	6.9	80	14.72	13
7.5/1.88	1800/900	200-230	213T	Y488	213TTDW7202		\$1,803	S3	86.5	21.6-19.8	110	17.30	
	1800/900	460	213T	Y489	213TTDW7201	√	\$1,803	S3	87.5	9.6	118	17.30	
10/2.5	1800/900	200-230	215T	Y490	215TTDW17206		\$2,277	S3	86.5	29.0-26.4	87	18.55	F, 13
	1800/900	460	215T	Y491	215TTDW7201		\$2,277	S3	86.5	12.5	106	17.30	
15/3.75	1800/900	460	256T	Y492	256TTDX7207		\$2,990	S3	87.5	18.4	217	22.32	
20/5	1800/900	460	284T	Y493	284TTDP7202		\$3,721	S3	87.5	25.0	320	23.49	

Blue shaded areas are cast iron frames.

MULTI-SPEED: TWO-SPEED, TWO-WINDING, VARIABLE TORQUE MOTORS

ADDITIONAL FEATURES:

- Economical two-winding design

HP	RPM	VOLTS	FRAME	CAT. NO.	MODEL NO.	STOCK	LIST PRICE	MULT. SYMB.	NOM. EFF.	FL. AMPS	WT.	"C" DIM.	FOOT NOTES
1/2.5	1800/900	460	145T	Y465	145TTDR5701	√	\$1,251	S3	79.5	1.5	42	12.99	5, 13
1/4.4	1800/1200	200-230	145T	Y449	145TTDR5703	√	\$1,251	S3	80.0	3.4-3.2	42	12.99	5, 13
	1800/1200	460	145T	Y450	145TTDR5704		\$1,251	S3	78.5	1.5	39	12.49	5, 13
1.5/3.7	1800/900	460	145T	Y466	145TTDR5702	√	\$1,372	S3	78.5	2.2	47	13.49	5, 13
1.5/6.7	1800/1200	200-230	145T	Y451	145TTDR5705	√	\$1,372	S3	80.0	5-4.8	47	13.49	5, 13
	1800/1200	460	145T	Y452	145TTDR5706	√	\$1,372	S3	78.5	2.3	42	12.99	5, 13
2/5	1800/900	460	182T	Y467A	182TTDW7411	√	\$1,512	S3	82.0	2.8	68	13.69	13
2/8.8	1800/1200	200-230	182T	Y1453	182TTDW7413	√	\$1,512	S3	80.0	6.6-6.4	60	12.69	13
2/9	1800/1200	460	182T	Y409A	182TTDW7211	√	\$1,512	S3	80.0	3.2	60	12.69	13
3/7.5	1800/900	460	184T	Y468A	184TTDW7230	√	\$1,575	S3	82.5	4.0	80	13.19	13
3/1.3	1800/1200	200-230	184T	Y454A	184TTDW7286	√	\$1,575	S3	81.5	9.2-8.6	74	13.69	13
	1800/1200	460	184T	Y412A	184TTDW7215	√	\$1,575	S3	81.5	4.3	74	13.69	13
5/1.25	1800/900	460	215T	Y469	215TTDW7205	√	\$2,203	S3	86.5	6.8	118	17.30	
5/2.22	1800/1200	200-230	215T	Y455	215TTDW7204	√	\$2,203	S3	85.5	14.5-14.0	116	17.30	
	1800/1200	460	215T	Y415	215TTDW7203	√	\$2,203	S3	85.5	6.5	106	17.30	
7.5/1.9	1800/900	460	254T	Y470	254TTDX7201		\$2,733	S3	85.5	10.5	135	20.57	
7.5/3.3	1800/1200	200-230	254T	Y456	254TTDX7278	√	\$2,733	S3	87.5	20.8-18.4	175	22.32	
	1800/1200	460	254T	Y418	254TTDX7208	√	\$2,733	S3	84.0	10.0	154	20.57	
10/2.5	1800/900	460	256T	Y471	256TTDX7253		\$3,388	S3	86.5	12.9	145	22.32	
10/4.4	1800/1200	200-230	256T	Y457	256TTDX7263		\$3,388	S3	88.5	28-26	214	22.32	
	1800/1200	460	256T	Y458	256TTDX7264	√	\$3,388	S3	87.5	12.0	214	22.32	
15/3.8	1800/900	460	284T	Y472	284TTDP7205		\$4,533	S3	88.5	18.0	300	23.49	
15/6.7	1800/1200	460	284T	Y459	284TTDP7221	√	\$4,533	S3	87.5	18.5	325	24.44	
	20/5	1800/900	460	286T	Y473	286TTDP7251		\$5,647	S3	88.5	25.0	321	24.99
20/8.9	1800/1200	460	286T	Y460	286TTDP7217	√	\$5,647	S3	88.5	25.0	326	24.99	

Blue shaded areas are cast iron frames.

INSTANT REVERSING MOTORS

SINGLE PHASE MOTORS

FEATURES:

- Thermal protection, as noted
- Electronic instant reverse switch
- Extended clamp screws for mounting belt guard or accessories
- Three pole, double throw reversing switch supplied by customer



CAPACITOR START, DRIPPROOF

HP	RPM	VOLTS	FRAME	OVER LOAD	CAT. NO.	MODEL NO.	STOCK	LIST PRICE	MULT. SYMB.	F.L. AMPS	WT.	"C" DIM.	FOOT NOTES
1/4	1800	115	48	NONE	CG382	5KC35GNA488	√	\$480	F1	5.2	14	9.57	20
1/3	1800	115	56	MANUAL	CG384	5KC35JNA489Y	√	\$591	F1	6.3	16	9.89	20
	1800	115	56	NONE	CG383	5KC35JNA489	√	\$583	F1	6.3	15	9.89	20
1/2	1800	115/230	56	MANUAL	C1459	5KC46GN0251Y	√	\$663	F1	8.8/4.4	21	10.78	19
	1800	115/230	56	NONE	C1458	5KC46GN0251	√	\$630	F1	8.8/4.4	21	10.78	19
3/4	1800	115/230	56	MANUAL	C1461	5KC46LN0252Y	√	\$755	F1	13.2/6.6	25	10.78	19
	1800	115/230	56	NONE	C1460	5KC46LN0252	√	\$732	F1	13.2/6.6	25	10.78	19
1	1800	115/230	56	NONE	C1469	5KC49PN0253	√	\$881	F1	13.6/6.8	31	11.38	18

CAPACITOR START, TEFC

HP	RPM	VOLTS	FRAME	OVER LOAD	CAT. NO.	MODEL NO.	STOCK	LIST PRICE	MULT. SYMB.	F.L. AMPS	WT.	"C" DIM.	FOOT NOTES
3/4	1800	115/230	56	MANUAL	C1489	5KC46PN0359Y	√	\$929	F1	11.0/5.5	31	11.83	17

PSC, DRIPPROOF

HP	RPM	VOLTS	FRAME	OVER LOAD	CAT. NO.	MODEL NO.	STOCK	LIST PRICE	MULT. SYMB.	F.L. AMPS	WT.	"C" DIM.	FOOT NOTES
1/3	1625/1325	115	56	MANUAL	P254	5KCP35KNB650U	√	\$591	F1	3.8	18	9.94	17
1/2	1625/1325	115	56	MANUAL	PG252	5KCP36NNB670U	√	\$630	F1	5.4	18	10.33	17
	1625/1325	115	56	MANUAL	P253	5KCP36NNB671U	√	\$663	F1	5.4	18	10.30	12, 17

PSC, TENV

HP	RPM	VOLTS	FRAME	OVER LOAD	CAT. NO.	MODEL NO.	STOCK	LIST PRICE	MULT. SYMB.	F.L. AMPS	WT.	"C" DIM.	FOOT NOTES
1/2	1625	115	48	AUTO	P247	5KCP35NNA670T	√	\$521	F1	5.8	18	9.42	17, 94, 96

DEFINITE PURPOSE

KILN DUTY, XRI® MOTORS

BLUE CHIP SERIES® SEVERE DUTY
TEAO, RIGID BASE, THREE PHASE MOTORS

APPLICATIONS:

Fans found in kilns and other high ambient environments where long life and high efficiency are desired. These TEAO motors must be mounted within the airstream for proper cooling. Suitable for use on variable frequency drives.

FEATURES:

- Blue Chip Series quality, 100% cast iron construction for rigidity and reduced vibration
- Internal and external epoxy paint
- CR²⁰⁰ corona resistant magnet wire
- Class H insulation system
- Normally closed thermostats (one per phase, Class H)
- Heat stabilized ball bearings and high temperature grease
- Suitable for inverter use, 20:1 variable torque with 1.0 S.F. IN 90°C ambient
- Suitable for 90°C ambient at 1.15 S.F. or 100°C ambient at 1.0 S.F.
- Extended grease tubes, regreasable in service
- 8 foot leads
- UL recognized and CSA certified



HP	RPM	VOLTS	FRAME	CAT. NO.	MODEL NO.	STOCK	LIST PRICE	MULT. SYMB.	NOM. EFF.	FL. AMPS	WT.	"C" DIM.	FOOT NOTES
1	1200	460	145T	S501	145TTTN18577		\$1,636	E9	80.0	1.7	59	11.43	
2	1800	460	145T	S503	145TTTN18531	√	\$1,636	E9	85.5	2.8	68	11.43	
	1800	575	145T	S553	145TTTN18532		\$1,636	E9	85.5	2.3	69	11.43	
	1200	460	184T	S504	184TTTS18577	√	\$2,263	E9	87.5	3.0	115	13.74	
	1200	575	184T	S554	184TTTS18578		\$2,263	E9	87.5	2.4	115	13.74	
3	1800	460	182T	S506	182TTTS18532	√	\$2,211	E9	90.2	3.9	106	13.74	
	1200	460	213T	S507	213TTTS17077		\$2,403	E9	89.5	4.3	191	15.69	
	1200	575	213T	S557	213TTTS17078		\$2,403	E9	89.8	3.5	175	15.69	
5	1200	460	215T	S510	215TTTS17077	√	\$2,766	E9	87.5	6.9	196	17.19	
	1200	575	215T	S560	215TTTS17078		\$2,766	E9	88.5	5.5	200	17.19	
7 1/2	1200	460	254T	S513	254TTTNA17077	√	\$3,393	E9	90.2	9.8	318	20.61	
	900	575	256T	S564	256TTTNA18601	√	\$3,800	E9	88.5	8.7	310	22.35	
10	1200	460	256T	S516	256TTTNA18578	√	\$3,890	E9	91.0	12.8	425	22.35	
	1200	575	256T	S566	256TTTNA18577		\$3,890	E9	91.0	10.2	425	22.35	
	900	460	284T	S517	284TTTNA18601	√	\$4,033	E9	88.5	15.2	475	23.42	
	900	575	284T	S567	284TTTNA17101	√	\$4,033	E9	88.5	12.1	457	23.42	
15	1800	460	254T	S518	254TTTNA18530	√	\$3,201	E9	92.4	18.2	276	20.61	
	1200	460	284T	S519	284TTTNA16577	√	\$4,659	E9	91.7	20.5	425	23.42	
	1200	575	284T	S569	284TTTNA18577		\$4,659	E9	91.7	16.4	475	23.42	
	900	460	286T	S520	286TTTNA18602		\$5,134	E9	88.5	23.0	505	24.92	
20	1200	460	286T	S522	286TTTNA18577	√	\$5,103	E9	91.7	27.0	520	24.92	
	900	460	324T	S523	324TTTS18601		\$6,235	E9	90.2	29.5	536	27.77	
25	1200	460	324T	S525	324TTTS18577		\$6,410	E9	93.0	32.5	675	27.77	
30	1200	460	326T	S528	326TTTS18577		\$6,788	E9	93.0	38.5	725	27.50	

Blue shaded areas are cast iron frames.

DEFINITE PURPOSE

OIL WELL PUMP, THREE PHASE MOTORS

DRIPPROOF, RIGID BASE MOTORS

APPLICATIONS:

For use on walking beam pumps found in oil field service.

FEATURES:

- NEMA® design D for extra high starting and breakdown torques
- Normally closed thermostats (one per phase, Class F)
- Fully guarded with screens on all external openings
- Copper bar rotor on 500 frame
- Low starting current with 5-8% slip
- Class F insulation
- F2 conduit box location
- Ball bearings (except as noted)
- Shaft slinger
- Special "oil well" duty
- 1.15 service factor



HP	RPM	VOLTS	FRAME	CAT. NO.	MODEL NO.	STOCK	LIST PRICE	MULT. SYMB.	NOM. EFF.	FL. AMPS	WT.	"C" DIM.	FOOT NOTES
3	1200	230/460/796	215T	Y201	215TTDW7376		\$2,064	S7	82.5	10.6/5.3/3.1	104	17.30	
5	1200	230/460/796	215T	Y202	215TTDW7377		\$2,384	S7	84.0	16.6/8.3/4.8	118	17.30	
7 1/2	1200	230/460/796	254T	Y203	254TTDX7377		\$3,068	S7	85.5	22.0/11.0/6.4	220	21.29	
10	1200	230/460/796	256T	Y204	256TTDX7391	√	\$3,785	S7	86.5	29.0/14.5/8.4	462	23.04	d
15	1200	230/460/796	284T	Y215	284TTDP7692	√	\$4,577	S7	87.5	41.0/20.5/11.9	330	23.44	
20	1200	230/460/796	286T	Y216	286TTDP7689	√	\$5,570	S7	87.5	53.0/26.5/15.3	368	24.94	
25	1200	460/796	324T	Y217	324TTDP7687	√	\$6,837	S7	88.5	34.0/19.7	460	26.00	
30	1200	460/796	326T	Y218	326TTDP7697	√	\$8,173	S7	88.5	40.0/23.1	498	27.50	d
40	1200	460/796	365T	Y209	365TTDS7383		\$10,731	S7	87.5	48.0/27.7	713	29.93	
50	1200	460/796	404T	Y210	404TTDS7387		\$12,965	S7	87.5	60.0/34.5	939	32.81	
60	1200	460/796	405T	Y211	405TTDS7697		\$15,292	S7	87.5	71.0/41.0	1018	34.31	
75	1200	460/796	444T	Y212	444TTDS8699	√	\$17,168	S7	90.2	91.5/53.0	1239	38.06	
100	1200	460/796	445T	Y213	445TTDS9477		\$22,891	S7	88.5	124.0/71.5	1327	40.06	
125	1200	460/796	505U	Y219	505UTDS1584		\$33,536	S7	90.2	175.0/101.0	1995	45.19	RB
150	1200	460/796	505U	Y220	505UTDS1590		\$35,837	S7	91.0	175.0/101.0	2282	45.19	RB

Blue shaded areas are cast iron frames.

DEFINITE PURPOSE

CONVECTION AND PIZZA OVEN MOTORS

SPLIT PHASE MOTORS (SINGLE AND TWO SPEEDS)

FEATURES:

- Double sealed ball bearings
- Service factor as noted
- 60° C ambient
- Automatic reset overload protector
- ODP enclosure (except as noted)



HP	RPM	VOLTS	FRAME	CAT. NO.	MODEL NO.	STOCK	LIST PRICE	MULT. SYMB.	FL. AMPS	BASE/MOUNTING	WT.	"C" DIM.	FOOT NOTES
1/3~0.09	1725/1140	100-115	56Y	F264V1	Century®	√	\$901	F1	6.2-6.0/3.0-2.8	Eared Bkt. /Removable Base	37	12.3	20, 68, 142
	1725/1140	200-230	56Y	F265	Century	√	\$901	F1	2.8-2.9/1.3-1.4	Eared Bkt. /Removable Base	27	12.3	20, 68, 142
1/3	1725	100-115/200-230	56Z	F267	Century	√	\$767	F1	5.0-5.2/2.5-2.6	Cushion Base	22	14.1	20, 57, 68, 106, 142
	1725	100-115/200-230	56Y	F266	Century	√	\$740	F1	5.0-5.2/2.5-2.6	Eared Bkt. /Removable Base	25	11.6	20, 68, 142
1/2	1725	100-115/200-230	56Y	F260	Century	√	\$1,034	F1	6.2-6.6/3.1-3.3	Special Flange	23	10.8	57, 142
	1725	100-115/200-230	56Y	F268V1	Century	√	\$1,033	F1	6.2-6.6/3.1-3.3	Eared Bkt.	21	10.6	57, 142
3/4	1725	115/230	56Y	F261	Century	√	\$1,332	F1	9.6/4.8	Special Flange	24	11.1	57, 142
	1725	115/230	56Y	F269	Century	√	\$1,332	F1	9.6/4.8	Eared Bkt.	17	10.9	142

PRESSURE WASHER, SINGLE PHASE MOTORS

DRIPPROOF MOTORS

FEATURES:

- Ball bearings, shaft end mechanically locked on C-face models
- Heavy gauge steel constructions
- Capacitor start/capacitor run design for higher efficiency (except as noted)
- Continuous duty, 1.15 service factor (except as noted)
- Thermal protection on some models
- UL recognized and CSA certified



RIGID BASE

HP	RPM	VOLTS	FRAME	OVER LOAD	CAT. NO.	MODEL NO.	STOCK	LIST PRICE	MULT. SYMB.	F.L. AMPS	WT.	"C" DIM.	FOOT NOTES
3/4	3600	115	56	MANUAL	9032	5KC49MN2049Y	√	\$398	F1	12.5	27	11.14	2, 17
	1800	115	56	AUTO	9030	5KC49NN0222X		\$555	F1	10.5	16	11.14	2, 17
	1800	115/208-230	56	MANUAL	K016	056B17D56	√	\$555	F1	11.0/5.5-5.5	25	11.47	
1	3600	115/208-230	56	MANUAL	D010	056B34D2029	√	\$457	F1	10.6/5.5-5.3	23	11.72	
	1800	115/230	56	MANUAL	C1480	5KC49PN0161U	√	\$604	F1	13.6/6.8	31	11.38	2
1 1/2	3600	115/208-230	56	MANUAL	G987	056B34D2021		\$622	F1	14.8/8.0-7.4	26	11.72	
	1800	115/208-230	56H	MANUAL	G958	056B17D5323	√	\$735	F1	13.2/7.2-6.6	39	11.94	5, 14
2	3600	115/208-230	56H	MANUAL	G976	056B34D5304		\$770	F1	17.6/9.7-8.8	34	11.44	5, 14
	1800	115/208-230	145T	MANUAL	I127	145TBDR5337	√	\$851	S1	18.8/10.2-9.4	48	13.49	14
	1800	115/230	56H	MANUAL	C210	Century®		\$851	F1	18.0/9.0	32	14.40	
	1800	115/208-230	56H	MANUAL	G979	056B17D5319		\$969	F1	18.8/10.2-9.4	47	13.44	5, 14
3	3600	208-230	56H	MANUAL	G996	056B34D5334		\$987	F1	14.2/12.5	44	12.44	5, 14
	1800	208-230	184T	NONE	I128A	184TBDW7631	√	\$995	S1	13.8-12.8	71	13.69	13
	1800	208-230	184T	MANUAL	I130A	184TBDW7630	√	\$1,077	S1	13.8-12.8	70	14.19	13
5	1800	208-230	184T	MANUAL	I119	184TBDR7375		\$1,420	S1	25.0-24.1	83	16.29	13
	1800	208-230	184T	NONE	I131A	184TBDW7632	√	\$1,434	S1	22.0-20.0	89	15.19	13
6	3600	230	56Y	MANUAL	B869	Century		\$1,265	F1	24.0	50	14.60	15, 17



C-FACE WITH RIGID BASE

HP	RPM	VOLTS	FRAME	OVER LOAD	CAT. NO.	MODEL NO.	STOCK	LIST PRICE	MULT. SYMB.	F.L. AMPS	WT.	"C" DIM.	FOOT NOTES
1 1/2	3600	115/208-230	56C	MANUAL	K212	056B34D2018		\$652	F1	14.8/8.0-7.4	26	11.72	
	1800	115/208-230	56HC	MANUAL	G290	056B17D5328		\$762	F1	13.2/7.2-6.6	39	11.94	5
2	3600	115/208-230	56HC	MANUAL	G294	056B34D5307		\$795	F1	16.8/9.4-8.4	34	11.44	5
	1800	115/208-230	56HC	MANUAL	K232	056B17D5322	√	\$950	F1	18.8/10.2-9.4	49	13.43	5
3	3600	208-230	56HC	MANUAL	K219	056B34D5336		\$1,012	F1	14.2-12.5	42	12.44	5
	1800	208-230	184TC	MANUAL	I305	184TBDR7628		\$1,181	S1	15.4-13.7	83	15.96	
5	3600	208-230	56HCZ	MANUAL	B182	Century		\$1,320	F1	22.0	42	14.50	15
	1800	208-230	184TC	MANUAL	I308	184TBDR7634		\$1,626	S1	25.0-24.1	97	16.96	

PRESSURE WASHER, SINGLE PHASE MOTORS

TOTALLY ENCLOSED FAN COOLED MOTORS

FEATURES:

- Ball bearings, shaft end mechanically locked on C-face models
- Heavy gauge steel constructions
- Capacitor start/capacitor run design for higher efficiency (except as noted)
- Continuous duty, 1.15 service factor
- Manual reset thermal protector
- UL recognized and CSA certified



RIGID BASE

HP	RPM	VOLTS	FRAME	CAT. NO.	MODEL NO.	STOCK	LIST PRICE	MULT. SYMB.	FL. AMPS	WT.	"C" DIM.	FOOT NOTES
3/4	3600	115/208-230	56	G379	056C34F5309	√	\$441	F1	10.6/5.3-5.3	26	12.32	2, 14
	1800	115/208-230	56	G356	056C17F5308	√	\$609	F1	11/5.4-5.5	29	12.32	2, 14
1	3600	115/208-230	56	G390	056C34F5311	√	\$499	F1	12.4/6.7-6.2	31	12.32	2, 14
	1800	115/208-230	56	G373	056C17F5311	√	\$638	F1	13.4/6.8-6.7	32	12.82	2, 14
1 1/2	3600	115/208-230	56	K332	056B34F5303		\$681	F1	12.0/7.5-6	37	13.32	14
	1800	115/208-230	56H	G378	056B17F5302	√	\$732	F1	15.2/8.2-7.6	41	13.82	5, 14
2	1800	115/230	145T	I702	145TBFR5336		\$942	S1	18.8/9.4	52	14.87	14

C-FACE WITH RIGID BASE

HP	RPM	VOLTS	FRAME	CAT. NO.	MODEL NO.	STOCK	LIST PRICE	MULT. SYMB.	FL. AMPS	WT.	"C" DIM.	FOOT NOTES
1/2	1800	115/208-230	56C	G380	056C17F5957		\$566	F1	8.8/4.2-4.4	27	11.82	2
3/4	1800	115/208-230	56C	G381	056C17F5955	√	\$677	F1	11/5.4-5.5	29	12.32	2
1	1800	115/208-230	56C	G382	056C17F5956	√	\$708	F1	13.4/6.8-6.7	31	12.82	2
1 1/2	3600	115/208-230	56C	K612	056B34F5306	√	\$706	F1	12.1/6.9-6	40	13.32	
	1800	115/208-230	56HC	G396	056B17F5310	√	\$806	F1	13.6/7.5-6.8	45	13.82	5
2	3600	115/230	56HC	K615	056B34F5312	√	\$838	F1	17.5/8.7	42	13.32	5
	3600	115/208-230	56HC	B861	Century®		\$1,067	F1	16.6/9.1-8.4	43	14.20	
	1800	115/230	145TC	I311	145TBFR5333		\$1,141	S1	18.8/9.4	52	14.87	
	1800	115/230	56HC	K319	056B17F5319	√	\$953	F1	18.8/9.4	51	14.82	5
	1800	115/230	56HC	C213	Century		\$1,267	F1	17.0/8.5	47	14.10	5
3	3600	230	56HC	K618	056B34F5318	√	\$1,057	F1	11.8	52	14.82	5
	1800	230	184TC	I314A	184TBFW7041	√	\$1,428	S1	12.8	73	14.96	13
5	1800	230	184TC	I315A	184TBFW7034	√	\$1,704	S1	19.5	101	17.47	13, 17

DEFINITE PURPOSE

WOODWORKING/POWER TOOL, SINGLE PHASE MOTORS

TOTALLY ENCLOSED, RIGID BASE MOTORS

APPLICATIONS:

Replacement motors for table saws, planers, lathes, and other equipment found in the woodworking and metalworking trades. These totally enclosed, fan cooled motors are well suited for use in dusty and dirty environments or where wood or metal shavings are present.

FEATURES:

- Capacitor start design for high starting torque with low amps
- Double sealed ball bearings
- Heavy gauge steel frame and base
- 1.15 service factor
- Manual reset thermal protection
- Dependable, dust-proof centrifugal starting switch
- On/off toggle switch and 8 foot cord with 115 volt plug included on 1/2 to 1-1/2 HP models
- UL recognized and CSA certified



HP	RPM	VOLTS	FRAME	CAT. NO.	MODEL NO.	STOCK	LIST PRICE	MULT. SYMB.	FL. AMPS	WT.	"C" DIM.	FOOT NOTES
1/2	1800	115/208-230	56	T010	056C17F5351	√	\$585	F1	8.8/4.2-4.4	29	11.82	2
3/4	3600	115/208-230	56	T013	056C34F5340	√	\$529	F1	10.6/5.3-5.3	27	12.32	2
	1800	115/208-230	56	T014	056C17F5350	√	\$684	F1	11.0/5.4-5.5	30	12.32	2
1	3600	115/208-230	56	T015	056C34F5339	√	\$588	F1	12.4/6.7-6.2	30	12.32	2
	1800	115/208-230	56	T016	056C17F5349	√	\$724	F1	13.4/6.8-6.7	31	12.82	2, d
1 1/2	3600	115/208-230	56	T017	056B34F5332	√	\$722	F1	14.2/7.7-7.1	33	12.82	1
	1800	115/208-230	56	T018	056B17F5328	√	\$878	F1	13.6/7.5-6.8	44	13.73	1
2	3600	115/230	56H	T019	056B34F5333	√	\$786	F1	17.5/8.7	36	13.41	1, 5
	1800	115/230	56H	T030	056B17F5329	√	\$969	F1	18.8/9.4	50	14.82	1, 5
3	3600	208-230	145T	T031	145TBFR5309	√	\$1,090	S1	13.1/11.8	51	14.87	1

50 HERTZ, THREE PHASE MOTORS

DRIPPROOF, RIGID BASE MOTORS

FEATURES:

- Ball bearings
- 1.15 service factor
- Nameplated 190-200-208/380-400-416 (except as noted)
- 12 Lead delta capability
- UL recognized and CSA certified



HP	RPM	VOLTS	FRAME	CAT. NO.	MODEL NO.	STOCK	LIST PRICE	MULT. SYMB.	NOM. EFF.	FL. AMPS	WT.	"C" DIM.	FOOT NOTES
2	1500	220/380	145T	KG319	5K49UN8052		\$730	E6	81.5	6.4/3.7	40	14.24	
	1500	190-208/380-416	145T	H952	145TTDR5647		\$730	E6	82.5	7.2-7.3/3.6-3.65	41	12.99	F, YD, 5, 14
3	1500	190-208/380-416	182T	H953	182TTDR8353	√	\$813	E6	81.5	10.0-9.8/5.0-4.9	60	13.22	F, YD, 25
5	1500	190-208/380-416	184T	H954	184TTDR9040	√	\$1,033	E6	82.5	16.2-15.6/8.1-7.8	80	14.72	F, YD, 13, 25
7 1/2	1500	190-208/380-416	213T	H955	213TTDW7053		\$1,356	E6	85.5	22.6-19.0/9.5-11.3	106	17.30	YD
10	1500	190-208/380-416	215T	H956	215TTDW7053		\$1,614	E6	88.5	31.0-29.1/15.5-14.5	135	17.30	YD
15	1500	190-208/380-416	254T	H957	254TTDX8338	√	\$2,137	E6	88.5	46.0-44.0/23.0-22.0	180	22.32	F, YD

MOD CENTRAL - MOTOR MODIFICATIONS

MOD CENTRAL

Regal offers the capability to modify stock motors in a matter of days to meet our customer's special needs. MOD CENTRAL is centrally located in Regal's distribution center in Indianapolis, Indiana. This state-of-the-art facility stocks a vast array of motors and accessories along with a staff of skilled technicians who provide the highest quality of service. If you need motor modifications on 20 motors or less and want to avoid special engineering and manufacturing schedules, call your local sales representative and take advantage of our MOD CENTRAL Motor Modification Program.

LEAD-TIME

All lead-times indicated are subject to availability of the stock motors and parts at the time of order placement. If a stock motor is shipped from a remote warehouse to Indianapolis for modification, the cost of the inbound freight will be added to the price of the modified motor and the delivery of the modified motor will be extended by the inbound transit time. (Lead-times in working days are calculated from normal business hours excluding holidays and weekends and do not include the day the purchase order is received.) Large quantities may require additional lead-time.

MOD CENTRAL HOURS

The Modification Center is open from 7:00 a.m. to 5:00 p.m. CST Monday through Friday.

HOW TO ORDER

First determine whether you need a kit to perform the modification, if you do not need a kit, then the modification list price includes all supplies to perform that modification. If a kit is needed, the modification list price is the labor to install the kit. The kit list price and the motor list price are not included. You must add the net price of the motor and kit to the net price of the modification(s) to calculate the total price of the modified motor.

For example, to add a C-Face kit and thermostats to catalog motor U633, you would calculate the total price as follows:

	LIST PRICE	MULT. SYMBOL
Kit 175191 (A653)	\$263	S4
Modification MOD2L, add C-Face to 254T-256T frame motor	\$311	S4
Modification MOD14E, add thermostats to 254T-256T frame motor	\$443	S4
TOTAL	\$1017	

Add the net price of U633 (\$2386 list price times (x) your motor multiplier) to the net adder for the kit and modifications (\$1017 times (x) your Mod Center multiplier of S4) to find the total net price for the modified motor

FREIGHT TERMS

Standard terms and conditions apply.

EXCEPTIONS

Some modifications do not apply to explosion proof motors.

DISCOUNT MULTIPLIER

Discount symbol S4 applies to all list prices, except where noted.

CANCELLATION POLICY

If a Mod Central order is cancelled after the motor is modified but before it ships, a cancellation charge of double the modification charge will be invoiced to the customer. Any Mod Central order cancelled before modifications are completed is subject to a cancellation charge of 25% of the total modification charges for that item.

ONCE SHIPPED MODIFIED MOTORS MAY NOT BE RETURNED FOR CREDIT OR RESTOCKING.

MOD CENTRAL - MOTOR MODIFICATIONS

MODIFICATION DESCRIPTION	MODIFICATION	PRODUCT	FRAME	LEAD-TIME
Altitude/Ambient				
AC motor altitude or ambient re-rating	MOD7	All Non-EXP	48-449T	2
AC motor altitude or ambient re-rating	MOD7	Explosion Proof	143T-449T	2
Assembly (see Mounting)				
Bearings				
Convert ball to roller (drive end)	MOD18	TEFC	364T-449T	3
Convert roller to ball (drive end)	MOD18	TEFC	444T-449T	2
Sealed bearing	MOD18	All Non-EXP	48-449T	Call
Insulated bearing	MOD18	Non Div 1 or 2	143T-449T	Call
Blowers				
Axial blower	MOD19	TEFC	213T-449T	3
Brackets				
C-Face non-explosion proof	MOD2	All Non-EXP	56-449T	2
C-Face explosion proof	MOD2	Explosion Proof	56,254T-449T	Call
C-Face IEEE 841	MOD2	All Non-EXP	143T-449T	2
D-Flange	MOD17	All Non-EXP	254T-365T	Call
B14 FT flange (IEC C-face)	MOD55	IEC	63-160	2
B5 FF flange (IEC D-flange)	MOD55	IEC	63-315	2
Brake Motors				
Brake motors-single phase	MOD3	TEFC	56C	3
Brake motors-three phase	MOD3	TEFC	56C-145TC	3
Brake motors-inverter duty	MOD3	TENV	56C-326TC	3
Electrical modifications-brake coil	MOD3	Brake Motors	56-256TC	10
Vertical brake mounting (shaft up or shaft down)	MOD3	All brakes	213-256T	3
Conduit Box				
Rotate conduit box lead opening	MOD56	All Non-EXP	143T-449T	2
Convert to cast iron	MOD56	All Non-EXP	143T-326T	2
Auxiliary box (condulet)	MOD56	All Non-EXP	182T-449T	Call
Connections				
SO cord, plug, and switch-single phase	MOD0	TEFC	48-215T	Call
Drains				
Condensation drain holes	MOD21	All Non-EXP	143T-449T	2
Brass drain & breather	MOD21	All Non-EXP	143T-449T	2
Stainless steel drain & breather	MOD21	All Non-EXP	143T-449T	2
Drip Covers				
Canopy cover	MOD4	ODP,TEFC	48-256T	2
Encoders				
Avtron® AV56 - Black Max® motor / Blue Max® motor	MOD22	TENV,TEBC	56-449T	2
Avtron HS25A & HS35A	MOD22	TENV,TEBC	56-449T	2
Avtron M56/M85 - Black Max motor / Blue Max brake motors	MOD24	TENV	143T-256T	2
Northstar® SL56 - Black Max motor / Blue Max motor	MOD22	TENV,TEBC	56-449T	2
Northstar SL56/SL85 - Blue Max brake motors	MOD24	TENV	143T-256T	2
Dynapar® HS20, HS35R, & HSD38 - Black Max motor / Blue Max motor	MOD22	TENV,TEFC,TEBC	56-449T	2
BEI® HS35 - Black Max motor / Blue Max motor	MOD31	TENV,TEFC,TEBC	56-449T	2
Stub shaft (XRI®-SD & XRI-841, TEFC motors only)	MOD42	TEFC	182-449T	2
Fan				
Oversized fan (see Inverter Duty modification)	MOD43	TEFC	213T-449T	2
Fan removal	MOD44	All Non-Exp	56-449T	2
Vane axial	MOD43	All Non-Exp	143T-449T	4
Frequency				
Frequency re-rate 60 Hz to 50 Hz	MOD7	All	56-449T	1
Grease/Fittings				
Grease relief fittings	MOD15	All Non-Exp	143T-449T	2
Zerk fittings (cast iron motors)	MOD15	All Non-Exp	182T-449T	2
Low temperature grease	MOD0	All	48-449T	2
High temperature grease	MOD0	All	48-449T	2

*Lead-time days does not include the day order is received.

Avtron is believed to be a trademark of Avtron Mfg. and is not owned or controlled by Regal Beloit Corporation.
 BEI is believed to be the trademark or trade name of Custom Sensors & Technology, Inc. and is not owned or controlled by Regal Beloit Corporation.
 Dynapar is believed to be a trademark of Danaher Corporation and is not owned or controlled by Regal Beloit Corporation.
 Northstar is believed to be a trademark of Northern Tool & Equipment and is not owned or controlled by Regal Beloit Corporation.
 NEMA is a trademark of National Electrical Manufacturers Association. All Rights Reserved.

Prices and specifications are subject to change without notice.

MOD CENTRAL - MOTOR MODIFICATIONS

MODIFICATION DESCRIPTION	MODIFICATION	PRODUCT	FRAME	LEAD-TIME
Grounding				
Conduit box grounding lug	MOD20	All	48-215T	2
On-frame grounding (cast iron motors)	MOD20	All	143T-449T	2
Shaft grounding ring	MOD20	Call	48-449T	2
Inverter Duty Motors				
Variable torque with thermostats (R140)	MOD25	All	143T-449T	2
Constant torque with thermostats (R142)	MOD26	All	143T-449T	2
Constant torque (R164)	MOD43	All	143T-449T	2
Leads				
Reconnect leads	MOD9	All	48-449T	2
Terminal lugs	MOD0	All	48-326T	2
Remark leads	MOD33	All	48-449T	2
Longer leads - up to 24"	MOD0	All Non-Exp	48-449T	2
Mounting/Assembly (Example: F1 to F2)				
Convert to floor, top, ceiling, or wall	MOD1	All Non-Exp	143T-449T	2
Convert to floor, top, ceiling, or wall	MOD39	Explosion Proof	143T-449T	2
Adjustable bases	MOD39	All	143T-449T	2
Nameplates/Markings				
Additional data on nameplate	MOD7	All	48-449T	1
CE Marking	MOD7	All	48-449T	2
Private Label	MOD7	All	48-449T	1
Rotation arrow	MOD7	Single Phase	48-215T	1
Separate nameplate for customer data	MOD7	All	48-449T	2
Stainless steel nameplate	MOD7	All	48-449T	1
Packaging				
Heat treated pallet	MOD29	All	48-449T	3
Paint				
Repaint to a Marathon® motor stock color	MOD8	All	48-449T	2-3
Screens				
Rodent screens	MOD0	ODP	364T-449T	Call
Service Factor				
AC motor service factor re-rating	MOD7	All Non-EXP	48-449T	1
Severe Duty Construction				
Cast iron fan cover and conduit box	MOD16	All Non-EXP	143T-449T	2
Shaft Grounding Ring (see Grounding)				
Shaft Modifications				
Drill & tap hole	MOD42	All	56-449T	3
TS shaft	MOD42	All	284T-449T	3
Mill flat on shaft	MOD0	All	56-184T	3
Steps on shaft	MOD0	All	143T-449T	Call
Space Heaters				
Non explosion proof	MOD12	All Non-EXP	48-449T	2
Explosion proof	MOD41	Explosion Proof	56-449T	2
IEC frames	MOD12	IEC	100-250	2
Terminal Blocks				
Terminal block	MOD0	All Non-EXP	180-449T	Call
Thermal Protection				
Thermostats-windings	MOD14	All	56-449T	2
Thermistors-windings	MOD14	All	143T-449T	2
Thermistors (including control module)	MOD14	All Non-EXP	143T-449T	2
Thermocouples - winding or bearing	MOD0	All Non-EXP	145T-449T	2
RTD's - winding	MOD14	All	143T-449T	3
Weatherproofing/Special Service				
Tropical anti-fungus treatment	MOD5	All	48-449T	2
Division 2 motors (CSA certified)	MOD49	Blue Chip®/XRI®	143T-449T	Call

*Lead-time days does not include the day order is received.

MOD CENTRAL - STOCK MOTORS ONLY

MULT. SYMBOL IS S4 (EXCEPT AS NOTED)

NEMA MOTORS DESCRIPTION	REQUIRES KIT	LIST PRICE													
		MOD #	48	56	143-145	182-184	213-215	254-256	284-286	324-326	364-365	404-405	444-445	447-449	
Altitude / Ambient:		7	\$182	\$182	\$182	\$182	\$182	\$182	\$182	\$182	\$182	\$182	\$182	\$182	
Bearings:															
Convert ball to roller (drive end)	Yes	18	—	—	—	—	—	—	—	—	—	\$319	\$319	\$398	\$398
Convert roller to ball (drive end)	Yes	18	—	—	—	—	—	—	—	—	—	—	—	\$398	\$398
Sealed bearings		18	\$314	\$314	\$314	\$419	\$419	\$577	\$735	\$996	\$1,728	\$1,728	\$2,356	\$2,356	
Insulated bearings		18	—	—	\$368	\$419	\$419	\$1,219	\$1,312	\$1,312	\$1,385	\$1,415	\$1,500	\$1,643	
Blowers:															
Axial blower	Yes	19	—	—	—	—	\$491	\$430	\$430	\$430	\$829	\$829	\$829	\$829	
Brackets: *															
C-Face (non-explosion proof)	Yes	2	—	\$228	\$228	\$268	\$268	\$311	\$462	\$524	\$524	\$524	\$524	\$524	
C-Face (explosion proof)	Yes	2	—	\$379	—	—	—	\$518	\$770	\$1,033	\$1,033	\$1,033	\$1,511	\$1,511	
C-Face (IEEE 841)	Yes	2	—	—	\$379	\$446	\$446	\$518	\$677	\$779	\$779	\$779	\$779	\$779	
D-Flange	Yes	17	—	—	—	—	—	\$268	\$383	\$650	\$650	—	—	—	
Brakes:															
3 lb-ft for a TEFC motor	Yes	3	—	\$263	\$263	—	—	—	—	—	—	—	—	—	
6 lb-ft for a TEFC motor	Yes	3	—	\$263	\$263	—	—	—	—	—	—	—	—	—	
10 lb-ft for a TEFC motor	Yes	3	—	\$263	\$263	—	—	—	—	—	—	—	—	—	
6 lb-ft for a Black Max® (TENV) motor	Yes	3	—	\$263	\$263	\$263	\$263	—	—	—	—	—	—	—	
10 lb-ft for a Black Max (TENV) motor	Yes	3	—	\$263	\$263	\$263	\$263	\$263	\$263	—	—	—	—	—	
Brake coil (56000 series)		3	—	\$653	\$653	\$653	—	—	—	—	—	—	—	—	
Brake coil (87000 series)		3	—	—	—	\$813	\$813	\$813	—	—	—	—	—	—	
Vertical mounting - shaft up	Yes	3	—	—	—	—	\$116	\$116	—	—	—	—	—	—	
Vertical mounting - shaft down	Yes	3	—	—	—	—	\$116	\$116	—	—	—	—	—	—	
Conduit Box:															
Rotate conduit box lead opening		56	—	—	\$231	\$231	\$231	\$231	\$231	\$231	\$231	\$231	\$231	\$231	
Convert to cast iron	Yes	56	—	—	\$252	\$252	\$252	\$277	\$300	\$346	—	—	—	—	
Auxiliary box (condulet)		56	—	—	—	\$346	\$346	\$461	\$461	\$461	\$692	\$692	\$692	\$692	
Connections:															
SO cord, plug, and switch single phase		0	\$457	\$457	\$457	\$457	\$457	—	—	—	—	—	—	—	
Drains:															
Condensation drain holes		21	—	—	\$273	\$273	\$273	\$304	\$304	\$304	\$304	\$304	\$304	\$304	
Brass drain & breather		21	—	—	\$290	\$290	\$290	\$520	\$520	\$520	\$520	\$520	\$520	\$520	
Stainless steel drain & breather		21	—	—	\$419	\$419	\$419	\$751	\$751	\$751	\$751	\$751	\$751	\$751	
Drip Cover:															
Canopy cover (ODP & TEFC motors)	Yes	4	\$193	\$193	\$193	\$193	\$255	\$408	—	—	—	—	—	—	
Encoders: (NOTE: Multiplier Symbol E3)															
Avtron® AV32	Yes	22	—	\$150	\$150	\$150	\$150	\$150	\$150	\$150	\$150	\$150	\$150	\$150	
Avtron AV56	Yes	22	—	\$150	\$150	\$150	\$150	\$150	\$150	—	—	—	—	—	
Avtron HS35A	Yes	22	—	\$150	\$150	\$150	\$150	\$150	\$150	\$150	\$150	\$150	\$150	\$150	
Avtron HS35M	Yes	22	—	\$150	\$150	\$150	\$150	\$150	\$150	\$150	\$150	\$150	\$150	\$150	
Avtron HS45															
Dynapar® HS20	Yes	22	—	\$150	\$150	\$150	\$150	\$150	\$150	—	—	—	—	—	
Dynapar HS35R	Yes	22	—	\$150	\$150	\$150	\$150	\$150	\$150	\$150	\$150	\$150	\$150	\$150	
NorthStar® HSD35	Yes	22	—	\$150	\$150	\$150	\$150	\$150	\$150	\$150	\$150	\$150	\$150	\$150	
NorthStar ST56	Yes	22	—	\$150	\$150	\$150	\$150	\$150	\$150	—	—	—	—	—	
Blue Max® TEBC Encoders:															
Avtron HS35A	Yes	24	—	—	—	—	—	—	\$150	\$150	\$150	\$150	\$150	\$150	
Avtron AV32	Yes	24	—	—	—	—	—	—	\$150	\$150	\$150	\$150	\$150	\$150	
Avtron AV56	Yes	24	—	—	—	—	—	—	\$150	\$150	\$150	\$150	\$150	\$150	
Dynapar HS35R	Yes	24	—	—	—	—	—	—	\$150	\$150	\$150	\$150	\$150	\$150	
NorthStar ST56	Yes	24	—	—	—	—	—	—	\$150	\$150	\$150	\$150	\$150	\$150	
Turck A02H	Yes	24	—	—	—	—	—	—	\$150	\$150	\$150	\$150	\$150	\$150	
Blue Max Brakemotor Encoders:															
Avtron AV56	Yes	24	—	—	\$336	\$336	—	—	—	—	—	—	—	—	
Avtron AV85	Yes	24	—	—	—	\$336	\$336	\$336	—	—	—	—	—	—	
NorthStar ST56	Yes	24	—	—	\$336	\$336	—	—	—	—	—	—	—	—	
NorthStar ST85	Yes	24	—	—	—	\$336	\$336	\$336	—	—	—	—	—	—	
Stub Shaft: (XRI®-SD & XRI-841, TEFC motors only)	Yes	42	—	—	\$290	\$290	\$290	\$290	\$290	\$290	\$290	\$290	\$290	\$290	
Fan:															
Oversized fan (Inverter Duty)		43	—	—	—	—	\$367	\$419	\$419	\$419	\$472	\$524	\$524	\$524	
Fan removal		44	—	\$285	\$285	\$359	\$359	\$346	\$346	\$346	\$405	\$405	\$405	\$405	
Vane axial		43	—	—	\$502	\$993	\$993	\$1,489	\$1,489	\$1,489	\$1,962	\$1,962	\$1,962	\$1,962	
Frequency:															
Re-rate 60Hz to 50Hz		7	\$182	\$182	\$182	\$182	\$182	\$182	\$182	\$182	\$182	\$182	\$182	\$182	
Grease/Fittings:															
Grease relief fittings		15	—	—	\$277	\$277	\$277	\$277	\$277	\$277	\$277	\$277	\$277	\$277	
Zerk fittings (cast iron motors)		15	—	—	—	\$440	\$440	\$440	\$440	\$440	\$440	\$440	\$440	\$440	
Low temperature grease		0	\$735	\$735	\$735	\$1,301	\$1,301	\$1,301	\$1,301	\$1,301	\$1,740	\$2,328	\$2,328	\$2,328	
High temperature grease		0	\$735	\$735	\$735	\$1,301	\$1,301	\$1,301	\$1,301	\$1,301	\$1,740	\$2,328	\$2,328	\$2,328	

* Addition of C-Face Kits may result in non-NEMA® "BA", dimension. For the resulting "BA" dimension consult chart found in modification section.
Contact your local sales representative for all modification services on Explosion Proof and Blower (TEBC) motors.

Continued on next page.

Avtron is believed to be a trademark of Avtron Mfg. and is not owned or controlled by Regal Beloit Corporation.
Dynapar and Danaher are believed to be trademarks of Danaher Corporation and are not owned or controlled by Regal Beloit Corporation.
Northstar is believed to be a trademark of Northern Tool & Equipment and is not owned or controlled by Regal Beloit Corporation.
NEMA is a trademark of National Electrical Manufacturers Association. All Rights Reserved.

Prices and specifications are subject to change without notice.

MOD CENTRAL - STOCK MOTORS ONLY

MULT. SYMBOL IS S4 (EXCEPT AS NOTED)

NEMA MOTORS DESCRIPTION	REQUIRES KIT	LIST PRICE												
		MOD #	48	56	143-145	182-1 84	213-215	254-256	284-286	324-326	364-365	404-405	444-445	447-449
Grounding:														
Conduit box grounding lug		20	\$167	\$167	\$167	\$188	\$188	—	—	—	—	—	—	—
On-frame grounding (cast iron motors)		20	—	—	\$231	\$158	\$252	\$381	\$381	\$381	\$532	\$532	\$532	\$532
Shaft grounding ring (E3 multiplier)	Yes	20	\$282	\$282	\$282	\$204	\$325	\$465	\$381	\$642	\$846	\$881	\$1,237	\$1,237
Inverter Duty Motors:														
Variable torque (R140)		25	—	\$443	\$443	\$278	\$443	\$443	\$443	\$443	\$443	\$443	\$443	\$443
Constant torque (fan chg, t-stats, re-nameplate)		26	—	\$443	\$443	\$278	\$443	\$703	\$703	\$703	\$703	\$864	\$864	\$864
Constant torque (R164, fan chg, re-nameplate)		43	—	—	\$367	\$230	\$367	\$419	\$419	\$419	\$472	\$524	\$524	\$524
Leads:														
Reconnect leads (non-explosion proof)		9	\$268	\$268	\$268	\$249	\$397	\$700	\$700	\$700	\$916	\$916	\$916	\$916
Reconnect leads (explosion proof)		40	\$432	\$432	\$432	\$417	\$665	\$896	\$896	\$896	\$1,130	\$1,130	\$1,130	\$1,130
Remark leads		33	\$281	\$281	\$281	\$176	\$281	\$281	\$281	\$281	\$281	\$281	\$281	\$281
Longer leads - up to 24"		33	\$220	\$220	\$220	\$207	\$330	\$577	\$577	\$577	\$808	\$808	\$808	\$808
Mounting/ Assembly: (Ex. F1 to F2):														
Non-explosion proof		1	—	—	\$333	\$209	\$333	\$443	\$443	\$443	\$553	\$553	\$553	\$553
Explosion proof		39	—	—	\$776	\$487	\$776	\$885	\$885	\$885	\$998	\$998	\$998	\$998
Adjustable motor bases	Yes	39	—	—	\$228	\$143	\$228	\$228	\$228	\$228	\$228	\$228	\$228	\$228
Transition motor bases	Yes	39	—	—	\$228	\$143	\$228	\$228	\$228	\$228	\$228	\$228	\$228	\$228
Nameplates / Markings:														
Additional data on nameplate		7	\$182	\$182	\$182	\$114	\$182	\$182	\$182	\$182	\$182	\$182	\$182	\$182
CE Marking		7	\$182	\$182	\$182	\$114	\$182	\$182	\$182	\$182	\$182	\$182	\$182	\$182
Private label		7	\$182	\$182	\$182	\$114	\$182	\$182	\$182	\$182	\$182	\$182	\$182	\$182
Rotation arrow		7	\$182	\$182	\$182	\$114	\$182	—	—	—	—	—	—	—
Stainless steel nameplate		7	\$182	\$182	\$182	\$114	\$182	\$182	\$182	\$182	\$182	\$182	\$182	\$182
Separate nameplate for customer data		7	\$182	\$182	\$182	\$114	\$182	\$182	\$182	\$182	\$182	\$182	\$182	\$182
Packaging:														
Heat treated pallets		29	\$80	\$80	\$80	\$50	\$199	\$199	\$398	\$398	\$398	\$398	\$398	\$398
Paint:														
Repaint to a Marathon® motor stock color		8	\$336	\$336	\$336	\$211	\$336	\$419	\$419	\$419	\$735	\$735	\$735	\$944
Screens:														
Rodent screens		0	—	—	—	—	—	—	—	—	\$1,053	\$1,053	\$1,053	\$1,053
Service Factor:														
AC motor service factor re-rating		7	\$182	\$182	\$182	\$114	\$182	\$182	\$182	\$182	\$182	\$182	\$182	\$182
Severe Duty Construction:														
Cast iron fan cover and conduit box	Yes	16	—	—	\$234	\$181	\$319	\$359	\$359	\$359	\$435	\$435	\$435	—
Shaft Modifications:														
Drill & tap hole		42	—	\$277	\$277	\$197	\$410	\$504	\$504	\$730	\$808	\$912	\$1,154	\$1,154
TS shaft		42	—	—	—	—	—	—	\$2,517	\$2,517	\$2,727	\$3,046	\$3,046	\$3,046
Mill flat on shaft		0	—	\$277	\$277	\$197	—	—	—	—	—	—	—	—
Steps on shaft		0	—	—	\$346	\$289	\$461	\$577	\$692	\$808	\$923	\$1,038	\$1,154	\$1,269
Space Heaters:														
Non explosion proof		12	\$443	\$443	\$443	\$400	\$638	\$751	\$751	\$751	\$1,053	\$1,053	\$1,053	\$1,053
Explosion proof		41	—	\$665	\$665	\$525	\$837	\$1,053	\$1,053	\$1,053	\$1,275	\$1,275	\$1,275	\$1,275
Terminal Blocks:														
Terminal block	Yes	0	—	—	—	\$294	\$469	\$559	\$559	\$559	\$571	\$571	\$696	\$696
Thermal Protection:														
Thermostats (non explosion proof)		14	—	\$443	\$443	\$278	\$443	\$443	\$443	\$443	\$443	\$443	\$443	\$443
Thermostats (explosion proof motors)		14	—	\$886	\$886	\$556	\$886	\$886	\$886	\$886	\$886	\$886	\$886	\$886
Thermistors (non explosion proof motors)		14	—	—	\$832	\$522	\$832	\$832	\$832	\$832	\$832	\$832	\$832	\$832
Thermistors (explosion proof motors)		14	—	—	\$1,678	\$1,053	\$1,678	\$1,678	\$1,678	\$1,678	\$1,678	\$1,678	\$1,678	\$1,678
Thermistors (including control module)		14	—	—	\$2,217	\$1,391	\$2,217	\$2,217	\$2,217	\$2,217	\$2,217	\$2,217	\$2,217	\$2,217
Thermocouples - winding or bearing (non XP)		0	—	—	\$486	\$305	\$486	\$761	\$761	\$761	\$916	\$916	\$916	\$916
RTD's - winding - top (non explosion proof)		14	—	—	\$2,265	\$2,265	\$2,265	\$2,265	\$2,265	\$2,265	\$2,265	\$2,265	\$2,265	\$2,265
RTD's - winding - top (explosion proof motors)		14	—	—	\$4,529	\$4,529	\$4,529	\$4,529	\$4,529	\$4,529	\$4,529	\$4,529	\$4,529	\$4,529
RTD's - winding - Per Phase (non explosion proof)		14	—	—	\$4,529	\$4,529	\$4,529	\$4,529	\$4,529	\$4,529	\$4,529	\$4,529	\$4,529	\$4,529
RTD's - winding - Per Phase (explosion proof motors)		14	—	—	\$5,875	\$5,875	\$5,875	\$5,875	\$5,875	\$5,875	\$5,875	\$5,875	\$5,875	\$5,875
Weatherproofing / Special Service:														
Tropical anti-fungus treatment		5	\$386	\$386	\$386	\$242	\$386	\$499	\$499	\$499	\$609	\$609	\$609	\$609
Division 2 hazardous (CSA certified)		49	—	—	\$182	\$339	\$540	\$703	\$703	\$703	\$357	\$357	\$357	\$357
Other Modifications:														
		0	CONSULT FACTORY											

NEMA MOTORS DESCRIPTION	REQUIRES KIT	LIST PRICE														
		MOD #	63	71	80	90	100	112	132	160	180	200	225	250	280	315
Brackets:																
FF Flange (B5)	Yes	55	\$252	\$258	\$271	\$285	\$319	\$352	\$352	\$352	\$352	\$352	\$352	\$352	\$352	\$352
FT Flange (B14)	Yes	55	\$252	\$258	\$271	\$285	\$319	\$352	\$352	\$352	—	—	—	—	—	—
Space Heaters:																
		12	—	—	—	—	\$645	\$800	\$800	\$883	\$883	\$883	\$1,104	\$1,104	\$1,104	\$1,104
Thermostats:																
		14	—	—	—	—	\$443	\$443	\$443	\$443	\$443	\$443	\$443	\$443	\$443	\$443
Heat Treated Pallets:																
		29	\$151	\$151	\$151	\$151	\$398	\$398	\$398	\$518	\$518	\$518	\$518	\$518	\$518	\$518
Other Modifications:																
		0	CONSULT FACTORY													

MODIFICATIONS

MOD CENTRAL - MOTOR MODIFICATIONS

ALTITUDE / AMBIENT - MOD7 (Mult. Symbol S4)

The rating of standard motors assumes operation at sea level. Listed motors are suitable for operation at altitudes up to 3,300 feet in a maximum ambient temperature of 40°C. The ambient temperature is the temperature of the cooling medium surrounding the motor. All standard motors are suitable for operation over the range of -15°C to 40°C ambient per NEMA® MG-1.

AC MOTOR ALTITUDE OR AMBIENT RE-RATING

Re-Rating of a non-explosion proof motor can be done by evaluating the performance data and possibly changing the service factor. Contact your local sales representative for motor capabilities prior to motor selection and modification.

BEARINGS - MOD18 (Mult. Symbol S4)

Most standard motors use anti-friction deep groove Conrad type ball bearing, sized for the loads to be expected in industrial applications. Roller bearings are used on the drive end to handle heavy or overhung (radial) shaft loads.

BALL TO ROLLER BEARING

Roller bearings have the capability to handle higher radial loads than ball bearings, but must have minimum radial loads to operate correctly. Roller bearings must only be used on belted loads. They are not suitable for direct-coupled loads. (Regal recommends that belting data is reviewed by Engineering prior to converting any motor to roller bearing.) This option includes replacing only the standard drive end bearing with a roller bearing and locking the opposite bearing axially. Available only on TEFC Blue Chip Series® and Blue Chip Series XRI® motors. Lead-time is 3 days.

ROLLER TO BALL BEARING

Larger horsepower motors are stocked standard with a roller bearing on the drive end. For direct-coupled applications, a ball bearing must be installed on the drive-end. Lead-time is 2 days.

SEALED BEARING

This modification provides the option of replacing the standard bearings in AC motors with sealed bearings and replacing the grease fittings with plugs. May not be suitable for belted applications. 250 - 449 frame, 3600RPM, no sealed bearing option. 250 - 445, 1800RPM and below, non contact sealed only. 48 - 215, All RPM's are available for sealed bearings. Consult your sales representative for full application details. Call for lead-time.

INSULATED BEARING

Insulated bearings are used to reduce the transmission of shaft currents. In accordance with NEMA Blowers - MOD19 (Mult. Symbol S4) Low rotational speeds, common in many vector drive applications, cause additional heat within the motor. As a result, these motors are designed as TENV or TEBC. The Marathon® brand is available with two types of blower units, depending upon the application requirements. The axial blower is available on XRI® and XRI-Severe Duty motors.

BLOWERS - MOD19 (Mult. Symbol S4)

Low rotational speeds, common in many vector drive applications, cause additional heat within the motor. As a result, these motors are designed as TENV or TEBC. The Marathon® brand is available with two types of blower units, depending upon the application requirements. The axial blower is available on XRI® and XRI-Severe Duty motors.

AXIAL BLOWER

Most TEBC requirements are satisfied with a Marathon® axial blower. The blower motor and fan are in the same (horizontal) plane as the motor drive shaft. Lead-time is 3 days.

C-FACE BRACKETS - MOD2 (Mult. Symbol S4)

The addition of a C-Face kit to a standard foot mount (rigid base) motor, results in a non-NEMA "BA" dimension in 143-256 Frames due to NEMA's establishment of two distinct "BA" dimensions for each of the affected frame sizes: one for rigid base motors and another for C-Face/rigid base motors. No motor manufacturer can meet both prescribed dimensions on reworked motors. The following table identifies the "BA" dimensions (defined as the distance from the center of the front foot hole to the shaft shoulder) for 143T-256T and TC frames:

NEMA FRAME	FOOT MOUNT*	C-FACE
143T-145T	2.38"	2.75"
182T-184T	2.75"	3.50"
213T-215T	3.50"	4.25"
254T-256T	4.25"	4.75"

D-FLANGE BRACKETS - MOD17 (Mult. Symbol S4)

Add a D-Flange Kit to rigid base, cast iron motor. Available on Blue Chip Series® motor 254T-365T and Dripproof 284T-286T ("TTDP" and "TTDC" designs). Addition of D-Flange Kit results in non-NEMA "BA" dimension or 254T-256T. Lead time is 2 days.

IEC BRACKETS - MOD55 (Mult. Symbol S4)

B14 FT FLANGE (IEC C-Face)

IEC mounting arrangement with the motor flange at the drive end similar to a NEMA C-Face motor. Modification includes motor disassembly and installation of a FT Flange to a Globetrotter® motor. Lead-time is 2 days.

B5 FF FLANGE (IEC D-Flange)

IEC mounting arrangement with the motor flange at the drive end similar to a D-Flange. Modification includes motor disassembly and installation of a FF Flange to Globetrotter® motor. Lead-time is 2 days.

BRAKE MOTORS - MOD3 (Mult. Symbol S4)

Spring-set, electrically released mechanical disc brakes are available for stopping and/or holding the load. The Marathon® motor brakes are suitable for any angle mounting. Price of modification includes brake kit and installation.

NEMA is a trademark of National Electrical Manufacturers Association. All Rights Reserved.

Prices and specifications are subject to change without notice.

MOD CENTRAL - MOTOR MODIFICATIONS

MOTOR HP	BRAKEMOTOR SHAFT R.P.M.		
	Lb-Ft @3600	Lb-Ft @1800	Lb-Ft @1200
1/4	—	—	3
1/3	—	3	3
1/2	3	3	3
3/4	3	6	6
1	3	6	6
1 1/2	6	10	10
2	6	10	—

BRAKE SELECTION CHART

** For normal (140%) torque rating, do not apply on motors larger than 2 HP. Reduced braking torque and/or longer Stopping times. can result from applying an undersized brake on higher HP motors.

BRAKE ADDITION - TEFC

This modification includes the addition of a 3,6, or 10 Lb-Ft brake to single or three phase, TEFC, 56 (5000 series model numbers) and 143/145T Frame motors. Operating voltages are 115/208-230, 208-230/460, and 575 volts. Lead-time is 3 days.

BRAKE ADDITION - INVERTER DUTY

This modification includes the addition of a 6 or 10 Lb-Ft brake to Black Max® or Blue Max® Vector Duty motors. Operating voltages are 115/208-230, 208-230/460, or 575 volts. Lead-time is 3 days.

BRAKE COIL VOLTAGE (Stearns® brakes only)

Brake coil changes allow for operation of brakes at various voltages on 50 or 60 Hertz AC power supplies. Available coil voltages at 50 HZ are 110, 220, 415, and 110/220 volts. Coil voltages at 60 HZ are 115, 200, 575, and 200/400 volts. Coil voltages at 60/50 HZ are 230/190, 460/380, and 208-230/460-190/380 volts. External brake coil lead connections will be brought out from the brake. Specify brake lead location, brake coil voltage, and supply frequency at time of order. Lead-time is 10 days.

MOD NUMBER	BRAKE RATING	BRAKE SERIES	LIST PRICE PER MOTOR
MOD3X	3 Ft/Lb	56,000	\$653
	6 Ft/Lb		
	10 Ft/Lb		
	15 Ft/Lb		
MOD3Y	25 Ft/Lb	87,000	\$813
	35 Ft/Lb		
	50 Ft/Lb		
	75 Ft/Lb		
	105 Ft/Lb		

VERTICAL MODIFICATION KIT (Stearns® 87,000 brake series)

Includes required hardware to accommodate vertical above (shaft down) or vertical below (shaft up) mounting.

TORQUE RATING (Lb/Ft)	MOUNTING	
	SHAFT UP	SHAFT DOWN
25,35	Not req'd	Required
50,75,105	Required	Required

CONDUIT BOX - MOD56 (Mult. Symbol S4)

Standard conduit box construction is based on the individual product description, e.g. severe duty motors always have a cast iron conduit box, while some standard duty motors come with stamped steel and others cast iron. Conduit boxes meet or exceed NEC 430.12 requirements for volume.

Termination of protective or monitoring devices can be provided in a separate auxiliary conduit box or conduit. Auxiliary conduit boxes are not available on explosion proof motors.

ROTATE CONDUIT BOX LEAD OPENING

Standard motors have lead opening facing down toward motor base. Modifications include rotating the conduit box so the lead opening is facing the desired direction. Specify lead opening location facing conduit box. Available on non-explosion proof motors. Lead-time is 2 days.

CONVERT TO CAST IRON

Replacement of steel conduit box with a cast iron conduit box. This modification is available on non-explosion proof cast iron motors as marathon's explosion proof integral stock motors come standard with a cast iron conduit box. Lead-time is 2 days.

AUXILIARY BOX (Condulet)

A condulet can be added to the main motor conduit box for routing of accessory leads. Available on ODP and TEFC (non-explosion proof) motors. Call for Lead-time.

CONNECTIONS - MOD0 (Mult. Symbol S4)

Motor connections consist of special cords, plugs, and switches added to a single phase motor.

DRAINS - MOD21 (Mult. Symbol S4)

Standard duty motors include a weep hole as standard, while severe duty and explosion proof motors include a brass drain/breather as standard. These are located in the drive end bracket at the lowest point.

CONDENSATION DRAIN HOLES

Additional drilled holes will be made in both end brackets of TEFC motors. Not available on explosion proof motors. Lead-time is 2 days.

BRASS DRAIN & BREATHER

Combination self-draining and breather plugs are available on TEFC motors. Not available on explosion proof motors. Lead-time is 2 days.

STAINLESS STEEL DRAIN & BREATHER

Combination self-draining and breather plugs are available on TEFC motors. Not available on explosion proof motors. Lead-time is 2 days.

DRIP COVERS - MOD4 (Mult. Symbol S4)

Drip covers can be furnished on standard motors for extra protection from dripping liquids and falling objects when the motor is mounted in the vertical shaft down position. These covers are recommended on all open dripproof and totally enclosed motors for vertical shaft down operation. These covers have no vertical lifting provisions provided.

MOD CENTRAL - MOTOR MODIFICATIONS

CANOPY COVER (OPD and TEFC Motors)

Modification includes installation of a sheet metal drip cover to the motor for vertical shaft down mounting. Available on rolled steel Dripproof motors through 256T frame and select TEFC motors. Lead-time is 2 days.

ENCODERS - MOD22, AND MOD24 (Mult. Symbol E3)

These electrical devices sense rotor speed and direction providing feedback to a control device. An encoder is a feedback device that translates mechanical motion into an electrical signal. A cable is connected from the encoder to the variable frequency drive to provide this feedback. Various mechanical provisions on the motor are required to attach the encoder. These may include C-Face on the non-drive end of the motor and special shaft extension. Various resolutions are available. All encoders offered have quadrature signal with line driver output.

Encoders can be mounted on Black Max® and Blue Max® 2000 Vector Duty motors, TENV 56 through 286T Frame, TEBC construction in 284T through 449T Frame.

STUB SHAFT - MOD42 (Mult. Symbol S4)

Add Stub Shaft to Fan Cooled XRI®-SD, XRI®-841 motors (182-449 Frames) to accommodate addition of encoder on opposite drive end of motor. Lead-time is 2 days.

FAN - MOD43, AND MOD44 (Mult. Symbol S4)

The Marathon® XRI® Severe Duty and IEEE841 motors have non-sparking fans made with, high-temperature, reinforced corrosion resistant plastic that is impervious to chemical attack and has been specially designed for motor applications. All motors utilize bi-directional cooling fans.

OVERSIZED FAN (Inverter Duty) - See MOD43 Inverter Duty

FAN REMOVAL - MOD44

TEFC to TEAO. Convert a motor from totally enclosed, fan cooled construction to totally enclosed, air-over by removing fan cover, fan, and cuttin goff the fan end shaft. The modified motor must be mounted in the air stream of the driven fan for cooling purposes. The customer is responsible for providing adequate airflow over the motor. Lead-time is 2 days.

VANE AXIAL FAN - MOD43

The modification can be done on rigid or C-Face mount, TEFC, TENV, EPFC, EPNV, or DP enclosures. Motors will be modified for Vane Axial fan applications. All motors will get an additional nameplate, and 42" extended leads. TEFC models will have the fan and fan guard removed and enclosure changed to TEAO. A minimum airstream velocity of 3000' per minute is required. Lead time is 4 days.

FREQUENCY - MOD7 (Mult. Symbol S4)

Most motors commonly operate on 60 hertz (HZ) within North America. However, 50 hertz systems are common in other countries.

FREQUENCY RE-RATE 60 HZ TO 50 HZ

Marathon® standard motors rated at 60 HZ may be operated at 50 HZ at reduced voltage and horsepower or service factor. A label containing specific re-rating information will be attached to the motor. Frame size is subject to change. Lead-time is 1 day.

GREASE/FITTINGS - MOD0, MOD15 (Mult. Symbol S4)

Standard grease is Exxon® Polyrex® EM with a bearing operating temperature range of -30° to +150°C for ball and roller bearings. Devices for installing grease into the motors, such as zerk fittings, are available.

GREASE RELIEF FITTINGS - MOD15

Install standard grease relief fitting on motor. Grease relief fittings serve as an outlet to equalize pressure in the motor. Not available on explosion proof motors. Lead-time is 2 days.

ZERK FITTINGS (Cast Iron Motors) - **MOD15**

Replace standard grease plugs on motors with zerk XRI® Severe Duty and IEEE841 motors come with zerk fittings as standard equipment. Not available on explosion proof motors. Lead-time is 2 days.

LOW TEMPERATURE GREASE - MOD0

Bearing grease may be changed to allow for a lower operation range. The motor bearings and end bells are purged and repacked with beacon 325 grease or equivalent with a temperature range of -60°C to +120°C. Call for lead-time.

HIGH TEMPERATURE GREASE - MOD0

Bearing grease may be changed to allow for a higher operating range. The motor bearings and end bells are purged and repacked with Dow Corning® DC44M grease or equivalent with a temperature range of -40° to +204°C. Call for lead-time.

GROUNDING - MOD20 (Mult. Symbol S4)

All motors 48 to 449T Frame have grounding provisions per NEMA® and NEC Standards. Explosion proof motors are permitted to have a frame ground, but electricaground in conduit box must also be connected.

CONDUIT BOX GROUNDING LUG

Add clamp-type grounding lug in the conduit box. Lead-time is 2 days.

ON-FRAME GROUNDING (Cast Iron Motors)

Addition of drilled and tapped hole on conduit box side of frame with installation of grounding lug. Available on non-explosion proof cast iron ratings only. Lead-time

BEARING CURRENT PROTECTION - BCP

BCP is a shaft current mitigation system utilizing shaft ground rings for MODS. They are recommended (NEMA MG1 31.4.4.3) as an effective means of bearing protection for motors operated from inverter power. One ring is adequate to bleed down inverter-sourced shaft voltages, thereby protecting both bearings for motors as large as 5011 frame. BCP may not be installed on motors used in Division 1 or Division 2 hazardous locations or motors with a modified shaft. Does not fit all motor types. Lead-time is 2 days.

INVERTER DUTY - MOD25, MOD26, AND MOD43 (Mult. Symbol S4)

"Inverter Duty" describes a class of motors that are capable of operation from a variable frequency drive. Many general purpose motors are suitable for most variable torque and some limited constant torque applications.

These motors do not have provisions for mounting encoders, but are suitable for use with volts/hertz or open loop vector controls. As required under USA Federal law, these motors comply with EAct efficiencies when operating from utility power.

Dow Corning is believed to be a registered trademark of Dow Corning Corporation and is not owned or controlled by Regal Beloit Corporation.

Exxon and Polyrex are trademarks of Exxon Mobil Corporation and are not owned or controlled by Regal Beloit Corporation.

NEMA is a trademark of National Electrical Manufacturers Association. All Rights Reserved.

Prices and specifications are subject to change without notice.

MOD CENTRAL - MOTOR MODIFICATIONS

INV. DUTY (LEADTIME 2 DAYS)

MOD #	APPL.	MTR. TYPE	MOD
25	Variable Torque	Any	Add thermostats, re-nameplate
26	10:1 CT 20:1 CT	EPA ^{ct} TEFC NEMA Premium [®] TEFC	Oversized fan, add thermostats, re-nameplate
43	10:1 C 20:1 CT	EPA ^{ct} TEFC NEMA Premium TEFC	Oversized fan, re-nameplate

Operation of motor on VFD exempts motor from EPA^{ct} mandated efficiency levels.

LEADS - MOD0, MOD9, AND MOD33, (Mult. Symbol S4)

All motors are provided with standard leads of ample length for easy connection in the conduit box to the power leads. Lead size and material are dependent upon the class of insulation system in the motor and the current capacity required.

RECONNECTION - MOD9

Reconnect dual voltage 9-lead or 12-lead motors to a 3-lead single voltage. Connection is made inside the motor frame. Specify desired voltage when ordering. On single phase motors, specify rotation. Lead-time is 2 days.

*Part Winding Start and Star-delta connections are excluded.

REMARK LEADS - MOD33

Using cloth markers, remark leads with numbers or letters. Please specify markings. Lead-time is 2 days.

LONGER LEADS - MOD0

Extend leads up to two feet longer than standard by splicing. Splice will be visible in conduit box. Not available on explosion proof motors. Lead-time is 2 days.

MOUNTING/ASSEMBLY - MOD1, AND MOD39 (Mult. Symbol S4)

Motors listed are horizontal, foot mounted. Many stock motors can be furnished in assembly positions as illustrated. Modification may include repositioning of vents, baffles, drains, and conduit box. Also end brackets are assembled and grease fittings are properly installed for operation with the motor in the position shown. No attempt is made to locate fittings on any particular side of the motor. Horizontal ball bearing motor assemblies W5, W6, W7, and W8 are not suitable for external thrusts in excess of rotor weight and half-coupling. Cast Iron ODP and TEFC, 360 and larger, are not suitable for vertical operation. Consult Engineering for TEFC Build Up. Lead-time is 2 days. SB300 - Prices and Specifications are subject to change without notice.

CONVERT TO FLOOR, CEILING, OR WALL MOUNT - MOD1

Convert standard F1 mount to F2, W1, W2, W3, W4, W5, W6, W7, W8, C1, or C2 mount. The mounting symbol is required when ordering to indicate the proper mounting. Lead-time is 2 days.

Example: Motor will be modified F1 to wall mounting W3

FLOOR MOUNTING ASSEMBLIES

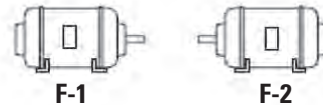

CEILING MOUNTING ASSEMBLIES

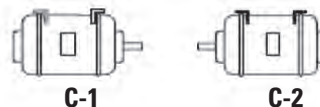

WALL MOUNTING ASSEMBLIES

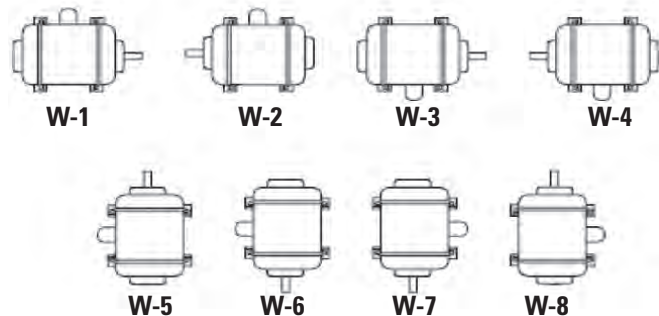

ADJUSTABLE MOTOR BASES - MOD39

Adjustable bases are a convenient means for adjusting belt tension or may be used as mounting plates. Adjustable motor bases are bolted to fixed base of motor prior to shipping. NEMA[®] 215T and smaller bases feature one adjusting screw. Bases on NEMA 254T and larger feature two adjusting screws. Bases are not suitable for vertical mounting. Lead-time is 2 days.

NAMEPLATES/MARKINGS - MOD7 (Mult. Symbol S4)

Nameplate material is mylar or stainless steel depending on motor design and enclosure.

ADDITIONAL DATA ON NAMEPLATE

Motors can be re-nameplated for alternate ratings. Changes in horsepower, altitude, ambient, voltage, frequency, etc. Lead-time is 1 day.

CE MARK

CE compliant mark can be provided for all non-explosion proof NEMA frame motors. Many stock motors already contain the CE mark. Lead-time is 2 days.

MOD CENTRAL - MOTOR MODIFICATIONS

ROTATION ARROW

All motors utilize bi-directional cooling fans. Specify rotation facing shaft extension on order entry form. Available on Single Phase only. Lead-time is 1 day.

STAINLESS STEEL NAMEPLATE

Replace existing Mylar® nameplate with 304 stainless steel nameplate. Lead-time is 1 day.

SEPARATE NAMEPLATE FOR CUSTOMER DATA

A separate customer nameplate can be furnished. Information contained must be submitted at time of order. These additional nameplates cannot be supplied with CSA or UL Listings unless installed to motor in a Regal facility. Lead-time is 2 days.

PACKAGING - MOD29 (MULT. SYMBOL S4)

HEAT TREATED PALLETS

ISPM-15 requires the use of heat-treated wooden packaging materials when shipping into all foreign countries (a temporary exemption exists for Canada). Modification includes replacement of wooden pallet with heat-treated pallet. Does not include export crating for ocean freight (contact factory for export packaging cost).

PAINT - MOD8 (MULT. SYMBOL S4)

The standard paint finish is a two-coat paint system. The first coat is a rust-inhibitive primer applied to protect the castings during storage and manufacturing. The second coat is a powder coat on 48-140 frame, enamel on non-severe duty motors, or a 2-part epoxy on severe duty 180-5000 frame motors. Special paints and color options are available if compatible and reviewed by application engineering. Paint chips and material safety data sheets are required.

REPAINT TO A MARATHON® STOCK MOTOR COLOR

Repaint motor to another Marathon stock motor paint color. Colors include: Marathon Blue Chip Series® blue, PowerWash™ white, farm duty black, Fire Pump red, light gray, or dark gray. Specify color on order. Lead-time on enamel paint is 2 days. Epoxy paint requires a 3 day lead-time.

SCREENS - MOD0 (MULT. SYMBOL S4)

Corrosion resistant screens can be furnished over the air intake and discharge openings of cast iron dripproof motors. Dripproof motors equipped with these screens conform to the dripproof guarded definition appearing in NEMA® MG-1, Part 1. Call for lead time.

SERVICE FACTOR - MOD7 (MULT. SYMBOL S4)

A multiplier that may be applied to the rated horsepower of a motor, which indicates a permissible horsepower loading at rated voltage and frequency. Lead-time is 1 day.

AC MOTOR SERVICE FACTOR RE-RATING

When a 1.15 Service Factor or higher is required, please refer to the list adder. Frame size is subject to change. Not available on explosion proof motors. Lead-time is 1 day.

SEVERE DUTY CONSTRUCTION - MOD16 (Mult. Symbol S4)

This modification starts with a Marathon® Blue Chip Series® motor totally enclosed cast iron frame motor and reworks it to all cast iron construction. With additional enhancements, the motor is prepared for a severe or harsh industrial environment. (USA domestic built product only) Remove polypropylene fan cover and sheet metal conduit box from the motor and replace with cast iron fancover, threaded and gasketed conduit box, apply epoxy finish to motor exterior, and add brass drain and breather. Lead-time is 2 days.

SHAFT MODIFICATION - MOD0, AND MOD42 (Mult. Symbol S4)

Motors are furnished with a single straight shaft with sled runner keyway and a rectangular key. For motors in frames 143T through 449T, a long shaft for V-Belt drive is supplied. 2-Pole motors in frames 324 through 449 and certain other 4-Pole ratings are furnished with short shafts for direct connections. Modifications are for existing shafts only. Not applicable if a new shaft is required.

DRILL & TAP HOLE - MOD42

Drilled radially or in the end of the shaft. Drilled and tapped in the end of the shaft. Lead-time is 3 days.

TS SHAFT - MOD42

Convert "T" frame shaft to a "TS" Frame shaft. Modify motor by reducing the shaft, adding new keyway, and shortening the shaft length to the NEMA "TS" dimension. Lead-time is 3 days.

MILL FLAT ON SHAFT - MOD0

Mill a flat on the drive end shaft extension. Provide detail of flat with the order. Lead-time is 3 days.

STEPS ON SHAFT - MOD0

One to three reductions in shaft diameter. Customer to specify number of reductions at time of order. Call for lead time.

Mylar is believed to be a registered trademark of Du Pont De Nemours and Company Corporation and is not owned or controlled by Regal Beloit Corporation.

NEMA is a trademark of National Electrical Manufacturers Association. All Rights Reserved.

Prices and specifications are subject to change without notice.

MOD CENTRAL - MOTOR MODIFICATIONS

SPACE HEATERS - MOD12 AND MOD41 (Mult. Symbol S4)

Space heaters are used to prevent the build-up of condensation on the windings of the motor when the motor is not operating. Space heaters are typically installed on the end-turns of the coils.

SPACE HEATERS - ODP & TEFC - MOD12

Space heaters can be furnished on dripproof and totally enclosed motors. Heater leads are normally brought out to the motor conduit box. Heater voltage is available in three voltages for 60 Hz operation of 115, 230, or 460 volt, single-phase. Space heaters are sized per NEMA® standards. Lead-time is 2 days.

SPACE HEATERS - IEC FRAMES - MOD12

Space heaters can be furnished on IEC motors. Heater leads are normally brought out to the main terminal box. Heater voltage is available in two voltages for 50 Hz operation. Lead-time is 2 days.

SPACE HEATERS - EXPLOSION PROOF - MOD41

Space heaters can be furnished on explosion proof motors. Heater leads are normally brought out to the motor conduit box. Heater voltage is available in three voltages for 60 Hz operation of 115, 230, or 460 volt, single-phase. Space heaters are sized per NEMA standards. Lead-time is 2 days.

TERMINAL BLOCKS - MOD57 (Mult. Symbol S4)

Conduit box mounted terminal blocks provide for a convenient termination of power leads. The terminal blocks are sized for the proper amperage and voltage of the motor. The Globetrotter® IEC motor has IEC terminal blocks as standard.

TERMINAL BLOCK

Install terminal blocks in conduit box of NEMA motor with lead connection. Customer to advise on lead connection. Call for lead-time. Contact factory to verify capability.

THERMAL PROTECTION - MOD14, MOD37 (Mult. Symbol S4)

Thermal protection are built in protective devices that prevent motor overheating. They work either by interrupting the power supply when the motor overheats or by incorporating a pilot device that opens the holding circuit of a magnetic starter or energizes an alarm bell or warning light.

THERMOSTATS - WINDINGS - MOD14

Thermostats are mounted on the stator winding and are temperature-sensing only, with normally closed snap action contacts. These devices are installed on the end-turns of the motor winding. Their purpose is to activate a warning device or shut down the motor upon excessive winding temperatures. The standard arrangement is the addition of 2 or 3 thermostats to the winding end-turns, connected in series with the leads brought out to the main motor conduit box. Class I Groups C & D / Class I Groups F & G Explosion Proof motors have hermetically sealed thermostats as standard. Lead-time is 2 days.

THERMISTORS - WINDING

Thermistors are small, non-linear resistance devices placed on the stator windings. As the critical temperature is reached, the resistance of the thermistor changes radically, causing operation of a control relay. The standard arrangement is Q-3 positive temperature coefficient (PTC) type on winding end-turns with leads brought out to the main motor conduit box. On IEC motors the leads are brought into a condulet adjacent to the main conduit box and includes a terminal block. As standard, 3 Texas Instrument thermistors are furnished, one per phase. Lead-time is 2 days.

RTDS - WINDINGS

RTDs are precision wire-wound resistors with calibrated temperature-resistance characteristics. The standard arrangement is the addition of a 100 ohm platinum RTD attached to the windings with the leads brought out to the main motor conduit box. These devices are used in conjunction with customer supplied instruments. Lead-time is 3 days.

WEATHERPROOFING/SPECIAL SERVICE

MOD5, MOD49, MOD58 (Mult. Symbol S4)

Weatherproofing or special service provides additional protection to windings and mechanical parts as well as special greases or modifications per industry specifications such as NEMA, IEEE, or automotive. Call for lead-time.

TROPICAL ANTI-FUNGUS TREATMENT - MOD5

Windings and mechanical parts coated with polyurethane for superior protection to resist tropical environments. Not available on brake motors. Lead-time is 2 days.

BRAND F EM-1 MOTORS - MOD48

Modify Blue Chip Series® XRI® Severe Duty motor to meet Ford Motor's EM-1 T-Frame automotive specification. Modification requires adding ABMA® bearing numbers and plugging second set of mounting holes on applicable frames. Lead-time is 2 days.

HAZARDOUS DUTY® SERVICE

DIVISION 2 HAZARDOUS MOTORS - MOD49

The Division 2 hazardous modification incorporates a new fan, fan guard, and nameplate on most TEFC motors. The nameplate will say "CSA Certified, Group I, Division 2 Groups A, B, C, and D, Temperature Code. XRI-SD and IEEE841 motors have the Division 2 statement on the nameplate as standard. (See chart below) Call for lead-time.

NEMA FRAME	SERVICE FACTOR	POWER SUPPLY	FREQUENCY RANGE	TEMP CODE
143-449T	1.0	SineWave	50-60Hz	T3
143-449T	1.0	PWM	3-120Hz	T2D
143-449T	1.15	SineWave	60Hz	T2B

ABMA is believed to be a registered trademark of American Bearing Manufacturers Association, Inc. and is not owned or controlled by Regal Beloit Corporation.
FNEMA is a trademark of National Electrical Manufacturers Association.
All Rights Reserved.

Prices and specifications are subject to change without notice.

ACCESSORY KITS - INDEX

DESCRIPTION	Page Number
BASES	
Adjustable Motor Bases	254
Transition Bases	254
BEARINGS	
Ball Bearing Conversion Kits	251
Roller Bearing Conversion Kits	251
BLOWERS	
Axial Blower Kits	251
BRACKETS	
C-Face Kits - Dripproof	239
C-Face Kits - NEMA Premium® / Globetrotter® dripproof motor	239
C-Face Kits - Totally enclosed	240
C-Face Kits - XRI® IEEE 841 motor	242
D-Flange Kits	242
FF (B5) flange (IEC D-Flange)	243
FT (B14) flange (IEC C-Face)	243
Metric flanges to reduce diameter	243
BRAKES	
Brake Kits - Single and three phase	244
Brake Kits - Inverter duty (Black Max® and Blue Max® motors)	244
Double C-Face coupler brake	244
Vertical modification kit	244
CAPACITOR KITS	
Capacitor mounting kit	246
Capacitor with mounting Kit	246
Oval run capacitors	246
Capacitor selection guide	247
CONDUIT BOX	
Cast iron conduit box kits	249
DRIP COVERS	
Motor rainshield/fan canopy	250
Drip cover kits (48-256T Frame)	248
ENCODERS, CABLES, AND STUB SHAFT	
Avtron® - Black Max® / Blue Max® motors	252
BEI® - Black Max / Blue Max motors	252
Dynapar® - Black Max / Blue Max motors	252
EPC® - Black Max / Blue Max motors	252
Northstar® - Black Max / Blue Max motors	252
Turck® - Black Max / Blue Max motors	252
Danaher® controls (cable kits)	252
Encoder stub shaft kit (XRI®-SD & XRI-841, TEFC motors only)	253
EXPLOSION PROOF	
Explosion proof conduit boxes	249
Lead exit reducer	249

All Kits Listed On This Page Are Stock

Avtron is believed to be a trademark of Avtron Mfg. and is not owned or controlled by Regal Beloit Corporation.
 BEI is believed to be the trademark or trade name of Custom Sensors & Technology, Inc. and is not owned or controlled by Regal Beloit Corporation.
 EPC is believed to be the trademark of Encoder Products Company and is not owned or controlled by Regal Beloit Corporation.
 Dynapar and Danaher are believed to be trademarks of Danaher Corporation and is not owned or controlled by Regal Beloit Corporation.
 Northstar is believed to be a trademark of Northern Tool & Equipment and is not owned or controlled by Regal Beloit Corporation.
 Turck is believed to be the trademark or trade name of Turck Corporation and is not owned or controlled by Regal Beloit Corporation.
 NEMA Premium is a trademark of National Electrical Manufacturers Association. All Rights Reserved.

Prices and specifications are subject to change without notice.

ACCESSORY KITS - INDEX

DESCRIPTION	Page Number
GROUNDING	
AEGIS® - Shaft Grounding Ring Kits	253
Conductive Epoxy	253
Replacement Ground Brush Parts	253
MOUNTING	
48 Frame Lug Mount Kits	246
Brand F Adapter Plate	246
Brand F Mounting Kit	246
Length Adapter Kit	246
Resilient Base Latches	245
Resilient Base (includes latches)	245
Resilient Mounting Kit	245
Resilient Ring Kit	245
Brand R Mounting Kit	246
Rubber Mounting Hardware	245
Split Mounting Rings	245
5K MOTOR ACCESSORIES	
Base Plates	250
Bearings	250
C-Face Endsheids	250
Capacitors	250
ODE Endsheids	250
Square Flange Endsheids	250
Start Mechanisms	250
Switches	250
Voltage Change Plug	250
Pool Motor Rainshield Kit	250
SEVERE DUTY CONSTRUCTION (UPGRADE KITS)	
Cast Iron Fan Cover and Conduit Box Kits	250
Globetrotter Fan Guard Kits	249
Cast Iron Conduit Box Kits	249
SHAFT KITS	
Blower Wheel Remover	247
Brass Punch	249
Encoder Stub Shaft Kit (XRI®-SD & XRI-841,TEFC motors only)	253
Shaft Adapter Sleeve	247
Shaft Lock Device	247
Tapered Fork	247
SWITCHES	
Toggle Switches	247
TERMINAL BLOCK KITS	
Terminal Block Kits - 182 to 449 Frames	243

ACCESSORY KITS - MULTIPLIER SYMBOL S4

Complete kits with hardware necessary for converting Marathon® stock rigid base motors to “C-Face” mounting with rigid base.



Excludes Blue Chip Series® XRI® Dripproof stock motors, see below

C-FACE KITS - DRIPPROOF

CAT. NO.	FRAME	KIT NO.	LIST PRICE	WHERE USED (MODELS CONTAINING)	WT.	FOOT NOTES
A435	56	KIT 56CDR-1	\$59	A 6203 (17mm) bearing	3	
AG212	56	161L185AAG1	\$59	A 6203 bearing (5K Type, 30 Frame)	3	
A534	56	161L187BAG1	\$59	A 6203 bearing (5K Type, 40 Frame)	3	
A436	56-143T-145T	KIT 140TCDR-1	\$110	A 6205 (25mm) bearing & E927, E928, and E929	3	75
A535	143T-145T	161L187BCG1	\$110	A 6205 bearing (5K Type, 40 Frame)	3	75
A600	143T-145T	KIT 175181	\$110	U244, U245, U246, U265, U758, U759, and U760	5	75
WD140TCDR	143T-145T	Century®	\$144	TO models	3	75
A160	182T-184T	KIT 180TCD-WD	\$163	TTDB (2,4 and 6 pole)	14	75
A666	182T-184T	KIT 175691	\$163	TTDW	14	75
WD180TCDR	182T-184T	Century	\$165	TO models	14	75
A161	213T-215T	KIT 210TCD-WD	\$228	TTDB or TTDBD (2,4 and 6 pole)	22	75
A602	213T-215T	KIT 175066	\$228	U268, U269, U763, U764, U765, and U766	18	75
A606	213T-215T	KIT 210TCDW	\$228	TTDW, TTDWD, TBDW, or TCDW	13	75
WD210TCDR	213T-215T	Century	\$228	TO models	22	75
A162	254T-256T	KIT 250TCD2-WD	\$263	TTDB (2 pole only)	32	75
A162A	254T-256T	B176066.00	\$263	TTDBD (2 pole only)	32	75
A163	254T-256T	KIT 250TCD-WD	\$263	TTDB (4 and 6 pole only)	32	75
A163A	254T-256T	B176067.00	\$263	TTDBD (4 and 6 pole only)	32	75
A612	254T-256T	KIT 250TCDX	\$263	TTDX	13	75
A622	254T-256T	KIT 175067	\$263	U254, U255, U767, U768, U769, and U770	27	75
A213	284T-286T/TS	KIT 320TCDR	\$845	TTDR (2,4 and 6 pole)	53	75
A210A	284T-286T/TS	KIT 280TCDR	\$488	TTDR (2,4 and 6 pole)	36	75
A287	284T-286T/TS	KIT 280TCDC	\$488	TTDC/N	38	75
A610	284T-286T/TS	KIT 280TCDP	\$488	TTDP or TSTDP	30	75
A1287	284T-286T/TS	KIT 280TCDCA	\$488	TTDCA	45	75
A164	284TS-286TS	KIT 280TCD2-WD	\$488	TSTDCA (2 pole only)	38	75
A164A	284TS-286TS	B176068.00	\$488	TSTDBD (2 pole only)	38	75
A626	284T-286T	KIT 175058	\$488	U256, U257, U771, U772, U773, and U774	32	75
A165	284T-286T	KIT 280TCD-WD	\$488	TTDCA (4 and 6 pole only)	38	75
A165A	284T-286T	B176069.00	\$488	TTDBD (4 and 6 pole only)	38	75
WD280TCD	284T-286T	Century	\$755	TO models (6 pole only)	38	75
A166	324TS-326TS	KIT 320TCD2-WD	\$845	TSTDCA (2 pole only)	45	
A166A	324TS-326TS	B176070.00	\$845	TSTDBD (2 pole only)	45	
A613	324T-326T/TS	KIT 320TCDP	\$845	TTDC/P or TSTDC/P	43	
WD320TCD2	324TS-326TS	Century	\$956	TO models (2 pole only)	45	
A167	324T-326T	KIT 320TCD-WD	\$845	TTDCA (4 and 6 pole only)	45	
A167A	324T-326T	B176071.00	\$845	TTDBD (4 and 6 pole only)	45	
A627	324T-326T	KIT 175059	\$845	U775, U776, U777, U778, U798 and U799	39	
WD320TCD	324T-326T	Century	\$977	TO models (4 and 6 pole only)	45	
A168	364TS-365TS	KIT 360TCD2-WD	\$1,073	TSTDCB (2 pole only)	85	
A168A	364TS-365TS	B176072.00	\$1,073	TSTDBD (2 pole only)	85	
A219	364TS-365TS	KIT 360TSCDS	\$1,073	TSTDC/S	62	
WD360TCD2	364TS-365TS	Century	\$1,216	TO models (2 pole only)	85	
A628	364T-365T	KIT 175060	\$1,073	U779, U782, U783, U784, U927, and U928	56	
A629	364T-365T	KIT 175601	\$1,073	U1779, U1782, U1783, U1784, U1927, and U1928	56	
A216	364T-365T	KIT 360TCDS	\$1,073	TTDC/S & E921	71	
A169	364T-365T	KIT 360TCD-WD	\$1,073	TTDCB (4 and 6 pole only)	85	
A169A	364T-365T	B176073.00	\$1,073	TTDBD (4 and 6 pole only)	85	
WD360TCD	364T-365T	Century	\$1,248	TO models (4 and 6 pole only)	85	
A225	404TS-405TS	KIT 400TSCDS	\$1,173	U250 and U251	89	
A414	404TS-405TS	KIT 400TCD2-WD	\$1,173	TSTDC (2 pole only)	95	
A414A	404TS-405TS	B176074.00	\$1,173	TSTDCA (2 pole only)	95	
A225	404TS-405TS	KIT 400TSCDS	\$1,173	TSTDS	89	

ACCESSORY KITS - MULTIPLIER SYMBOL S4

C-FACE KITS - DRIPPROOF

CAT. NO.	FRAME	KIT NO.	LIST PRICE	WHERE USED (MODELS CONTAINING)	WT.	FOOT NOTES
WD400TCD2	404TS-405TS	Century®	\$1,173	TO models (2 pole only)	89	
A222	404T-405T	KIT 400TCDS	\$1,173	TTDS & E922, E923, U270, and U271	82	
A415	404T-405T	KIT 400TCD-WD	\$1,173	TTDC (4 and 6 pole only)	95	
A415A	404T-405T	B176075.00	\$1,173	TTDCD (4 and 6 pole only)	95	
WD400TCD	404T-405T	Century	\$1,173	TO models (4 and 6 pole only)	95	
A231	444TS-445TS	KIT 440TSCDS	\$2,244	TSTDS	119	
A416	444TS-445TS	KIT 444/5TCD2-WD	\$2,244	TSTDC (2 pole only)	140	
A416A	444TS-449TS	B176076.00	\$2,244	TSTDCD (2 pole only)	140	
WD440TCD2	444TS-449TS	Century	\$2,244	TO models (2 pole only)	140	
A293	447TS-449TS	KIT 440TSCDN	\$2,244	TSTDN	144	
A228	444T-445T	KIT 440TCDS	\$2,244	TTDS & U272, U273, E924, E925 and E926	116	
A417	444T-445T	KIT 444/5TCD-WD	\$2,244	TTDC (4 and 6 pole only)	140	
A417A	444T-449T	B176077.00	\$2,244	TTDCD (4 and 6 pole only)	143	
WD440TCD	444T-449T	Century	\$2,244	TO models (4 and 6 pole only)	140	
A419	447T-449T	KIT 447/9TCD-WD	\$2,244	TTDC (6 pole only)	140	

ACCESSORY KITS - MULTIPLIER SYMBOL S4

Complete kits with hardware necessary for converting Marathon® stock rigid base motors to "C-Face" mounting with rigid base. Includes Globetrotter®, XRI® (AS NOTED), and severe duty motors.

Excludes Blue Chip Series® XRI® IEEE-841 stock motors, available on the next page.



C-FACE KITS - TOTALLY ENCLOSED

CAT. NO.	FRAME	KIT NO.	LIST PRICE	WHERE USED (MODELS CONTAINING)	WT.	FOOT NOTES
A437	56	KIT 56CFR-1	\$59	A 6203 (17mm) bearing (standard frame)	3	
AG215	56	161L186AAG1	\$59	A 6203 bearing (5K Type, 30 Frame)	3	
A536	56	161L188BAG1	\$59	A 6203 bearing (5K Type, 40 Frame)	3	
A665	56	KIT 175076	\$59	Use on 56 frame XRI-NEMA Premium® rolled steel models	5	
A438	56-143T-145T	KIT 140TCFR-1	\$110	A 6205 (25mm) bearing or TBFR, TCFR, TTTR, or TTFR	5	75
A537	140T	161L188BCG1	\$110	A 6205 bearing (5K Type, 40 Frame)	5	75
A603	143T	KIT 143TCFN	\$110	TTFN, TTTC, or TTTN	5	75,76
A642	140T	KIT 175077	\$110	Use on 140 frame XRI-NEMA Premium rolled steel models	5	75
A655	145T	KIT 145TCFN	\$110	TTFN, TTTC, or TTTN	5	75,76
WD140TCF	140T	Century	\$150	TE or SD models	5	75
A170	182T-184T	KIT 180TCF-WD	\$163	TTFBA (Globetrotter motor)	14	75
A420	182T-184T	B176240.00	\$163	TTFCD (Globetrotter motor)	14	75
A640	182T-184T	KIT 180TCN4.5	\$163	TTFN (Non-Std. 4-1/2" AK dim.)	14	75
A641	182T-184T	KIT 180TCN8.5	\$163	TTFN (8-1/2" AK)	14	75
A643	182T-184T	KIT 175296	\$163	Use on model numbers 182/4TTFR4026 (8-1/2"AK)	14	75
A644	182T-184T	KIT 180CF8.5-1	\$163	TTTL/S, TCFL/R, TTFC/L/R/S or THTS (Standard 8-1/2" AK dim.)	14	75
A645	182T-184T	KIT 180CF4.5-1	\$163	TTFC (Not XRI)/L/R/S (Non-Std. 4-1/2" AK dim.)	14	75
A666	182T-184T	KIT 175691	\$163	TCFW, TBFW, TTFW	14	75
WD180TCFS	182T-184T	Century	\$169	TE or SD models	14	75
A171	213T-215T	KIT 210TCF-WD	\$228	TTFBA of TTFBD (Globetrotter motor)	22	75
A421	213T-215T	KIT 210TCFCD-WD	\$228	TTFCD (Globetrotter motor)	22	75
A204	213T-215T	KIT 210TCFL	\$228	TTFL/R or TBFL	17	75
A206	213T-215T	KIT 210TCFS	\$228	TTFC (Not XRI)/S, THFS, TTTS and THTS (except 213/5TTFC4075)	17	75
A609	213T-215T	KIT 210TCFW	\$228	TBFW, TTFW	17	75
A646	213T-215T	KIT 210TCN	\$228	TTFN or TTFND	17	75
A652	213T-215T	KIT 175068	\$228	Use on models 213TTFC4076 and 215TTFC4076	17	75
A667	213T-215T	KIT 175844	\$228	XRI-NEMA Premium models containing TTFW1	17	75
WD210TCFS	213T-215T	Century	\$338	TE or SD models	22	75
A172	254T-256T	KIT 250TCF2-WD	\$263	TTFCA (2 pole only)(Globetrotter motor)	32	75
A173	254T-256T	KIT 250TCF-WD	\$263	TTFCA (4 and 6 pole only)(Globetrotter motor)	32	75

NEMA Premium is a trademark of National Electrical Manufacturers Association.

All Rights Reserved.

Prices and specifications are subject to change without notice.

ACCESSORY KITS - MULTIPLIER SYMBOL S4

CAT. NO.	FRAME	KIT NO.	LIST PRICE	WHERE USED (MODELS CONTAINING)	WT.	FOOT NOTES
A173A	254T-256T	B176026.00	\$263	TTFC (Globetrotter® motor)	32	75
A209	254T-256T	KIT 250TCFL	\$263	TTFL, and THTL (254TTFL4076)	21	75
A1209	254T-256T	KIT 250TCFL-R	\$263	TTFL1 and THTL1 (current frame design) (254TTFL14076)	21	75
A284	254T-256T	KIT 250TCFNA	\$263	TTFNA, and THTNA	35	75
A239	254T-256T	KIT 250TCFPA	\$263	TFPA, THPA, and TSTFPA	35	75
A601	254T-256T	KIT 250TCFP	\$263	TF (Not XRI, or 254/6TTFC4076)	35	75
A653	254T-256T	KIT 175191	\$263	Use on model numbers 254TTFC4076 and 256TTFC4076	21	75
WD250TCCFF	254T-256T	Century®	\$481	TE or SD models (2 pole only)	32	75
WD250TCCFF2	254T-256T	Century	\$315	TE or SD models (4 and 6 pole only)	32	75
A175A	284T-286T/TS	B176028.00	\$488	TTFC (Globetrotter motor)	38	
A611	284T-286T/TS	KIT 280TCFP	\$488	TF (Not XRI)/P, THFP, TSTFP or TSTFC (except 284/6TTFC4076)	31	
A615	284T-286T/TS	KIT 280TCFN	\$488	TFN or TSTFN	52	
A617	284T-286T/TS	KIT 280TCFPA	\$488	TFPA, THPA, and TSTFPA	45	
A618	284T-286T/TS	KIT 280TCFNA	\$488	TFNA, THNA, or TSTFNA	55	
A174	284TS-286TS	KIT 280TCF2-WD	\$488	TSTFCA (2 pole only)(Globetrotter motor)	38	
WD280TCCF3	284TS-286TS	Century	\$564	TE or SD models (2 pole only)	38	
A175	284T-286T	KIT 280TCF-WD	\$488	TF (4 and 6 pole)(Globetrotter motor)	38	
A654	284T-286T	KIT 175061	\$488	Use on model numbers 284TTFC4076 and 286TTFC4076	31	
WD280TCCF4	284T-286T	Century	\$571	TE or SD models (4 and 6 pole only)	38	
A177A	324T-326T/TS	B176030.00	\$845	TTFC (Globetrotter motor)	45	
A214	324T-326T/TS	KIT 320TCFS	\$845	TF, THFS, or TSTFS	90	
A614	324T-326T/TS	KIT 320TCFP	\$845	TF (Not XRI)/P, THFP, TSTFP or TSTFC	50	
A619	324T-326T/TS	KIT 320TCFPA	\$845	TFPA, THPA, AND TSTFPA	57	
A176	324TS-326TS	KIT 320TCF2-WD	\$845	TSTFCA (2 pole only)(Globetrotter motor)	45	
WD320TCCF2	324TS-326TS	Century	\$845	TE or SD models (2 pole only)	45	
A177	324T-326T	KIT 320TCF-WD	\$845	TFCA (4 and 6 pole only) (Globetrotter motor)	45	
WD320TCCF	324T-326T	Century	\$845	TE or SD models (4 and 6 pole only)	45	
A179A	364T-365T/TS	B176032.00	\$1,073	TTFC (Globetrotter motor)	85	
A178	364TS-365TS	KIT 360TCF2-WD	\$1,073	TSTFCA (2 pole only)(Globetrotter motor)	85	
WD360TCCF2	364TS-365TS	Century	\$947	TE models (2 pole only)	85	
A396	364TS-365TS	KIT 360TSCFSR	\$1,073	TSTFS or TSHFS	105	
A179	364T-365T	KIT 360TCF-WD	\$1,073	TFCA (4 and 6 pole only)(Globetrotter motor)	85	
A217	364T-365T	KIT 360TCFS	\$1,073	TF (Not XRI)	105	
A395	364T-365T	KIT 360TSCFSR	\$1,073	TF or THFS	105	
WD360TCCF	364T-365T	Century	\$1,073	TE or SD models (4 and 6 pole only)	85	
A226	404TS-405TS	KIT 400TSCFS	\$1,173	TSTFS or TSHFS	125	
A424	404TS-405TS	KIT 400TCF2-WD	\$1,173	TSTFC (2 pole only)(Globetrotter motor)	175	
A424A	404TS-405TS	B176034.00	\$1,173	TSTFCD (2 pole only)(Globetrotter motor)	175	
WD400TCF2	404TS-405TS	Century	\$1,207	TE models (2 pole only)	175	
A223	404T-405T	KIT 400TCFS	\$1,173	TF or THFS	125	
A425	404T-405T	KIT 400TCF-WD	\$1,173	TF (4 and 6 pole only)(Globetrotter motor)	175	
A425A	404T-405T	B176035.00	\$1,173	TTFC (4 and 6 pole only)(Globetrotter motor)	175	
WD400TCCF	404T-405T	Century	\$1,173	TE models (4 and 6 pole only)	175	
A232	444TS-445TS	KIT 440TSCFS	\$2,244	TSTFS or TSHFS	105	
A426	444TS-445TS	KIT 444/5TCF2-WD	\$2,244	TSTFC (2 pole only)(Globetrotter motor)	225	
A621	444TS-445TS	KIT 440TSCFN	\$2,244	TSTFN or TSHFN	200	
A229	444T-445T	KIT 440TCFS	\$2,244	TF or THFS	175	
A427	444T-445T	KIT 444/5TCF-WD	\$2,244	TF (4 and 6 pole only)(Globetrotter motor)	225	
A620	444T-445T	KIT 440TCFN	\$2,244	TFN or THFN	205	
A426A	444TS-449TS	B176036.00	\$2,244	TSTFCD (2 pole only)(Globetrotter motor)	250	
WD440TCF2	444TS-449TS	Century	\$2,244	TE models (2 pole only)	225	
A428	447/9TS	KIT 447/9TCF2-WD	\$2,244	TSTFC (2 pole only)(Globetrotter motor)	250	
A624	447/9TS	KIT 449TSCFS-1	\$2,244	TSTFS (6313 bearing), 2-Pole	200	
A625	447/9TS	KIT 449TSCFS-2	\$2,244	TSTFS (6318 bearing) 4-, 6-, and 8-Pole	200	
A427A	444T-449T	B176037.00	\$2,244	TTFC (4 and 6 pole only)(Globetrotter motor)	250	
WD440TCF	444T-449T	Century	\$2,244	TE models (4 and 6 pole only)	225	
A429	447/449T	KIT 447/9TCF-WD	\$2,244	TF (4 and 6 pole only)(Globetrotter motor)	250	
A623	447/449T	KIT 449TCFS	\$2,244	TF or THFS with ball bearings	200	

ACCESSORY KITS - MULTIPLIER SYMBOL S4

Complete kits with hardware and Inpro/Seal® necessary for converting Marathon® stock IEEE-841 rigid base motors to "C-Face" mounting with rigid base.

C-FACE KITS - BLUE CHIP SERIES® XRI® IEEE-841 MOTORS

CAT. NO.	FRAME	KIT NO.	LIST PRICE	WHERE USED (MODELS CONTAINING)	WT.	FOOT NOTES
A181	143T	KIT 143TCTN-841	\$233	THTN	9	75,76
A262	145T	KIT 145TCTN-841	\$233	THTN	9	75,76
A182	182T-184T	KIT 180TCFS-841	\$328	THTS or THFS	13	75
A182A	182T-184T	-	\$328	THTN OR THFN	13	75
A183	213T-215T	KIT 210TCFS-841	\$443	THTS or THFS	16	75
A183A	213T-215T	-	\$443	THTN OR THFN	16	75
A184	254T-256T	KIT 250TCFNA-841	\$507	THFNA	35	75
A185	284T/TS-286T/TS	KIT 280TCFN-841	\$950	THFN	52	
A186	284T/TS-286T/TS	KIT 280TCFNA-841	\$950	THFNA	52	
A187	324T/TS-326T/TS	KIT 320TCFS-841	\$1,559	THFS	89	
A188	364T-365T	KIT 360TCFSR-841	\$1,951	THFS	95	
A189	364TS-365TS	KIT 360TSCFSR-841	\$1,951	TSHFS	95	
A190	404T-405T	KIT 400TCFS-841	\$2,142	THFS	129	
A191	404TS-405TS	KIT 400TSCFS-841	\$2,142	TSHFS	118	
A192	444T-445T	KIT 440TCFS-841	\$2,979	THFS	175	
A193	444TS-445TS	KIT 440TSCFS-841	\$2,979	TSHFS	108	
A194	444T-445T	KIT 440TCFN-841	\$2,979	THFN	201	
A195	444TS-445TS	KIT 440TSCFN-841	\$2,979	TSHFN	199	

D-FLANGE KITS Complete kits with hardware necessary for converting Marathon stock rigid base motors to D-Flange mounting with rigid base.

CAT. NO.	FRAME	ENCLOSURE	KIT NO.	LIST PRICE	WHERE USED (MODELS CONTAINING)	WT.	FOOT NOTES
A650	284/286T/TS	ODP	KIT 650R	\$1,140	TTDPTDC (EPAAct),TSTDP or TSTDC (EPAAct)	38	
A670	324/326T	ODP	B176201.00	\$1,252	TTDBD	98	
A671	324/326TS	ODP	B176202.00	\$1,252	TTDBD	98	
A672	364/365T	ODP	B176203.00	\$1,344	TTDBD	121	
A673	364/365TS	ODP	B176204.00	\$1,344	TTDBD	121	
A647	254/256T	TEFC	KIT 250TDFPA	\$649	TTFPA	21	97
A648	254/256T	TEFC	KIT 250TDFNA	\$649	TTFNA	15	97
A649	254/256T	TEFC	KIT 649R	\$649	TTFP or TTFC (EPAAct)	39	97
A675	254/256T	TEFC	B176205.00	\$649	TTFC	39	
A656	284/286T	TEFC	KIT 280TDFNA	\$1,140	TTFNA	60	97
A651	284/286T/TS	TEFC	KIT 651R	\$1,140	TTFP, TTFC (EPAAct), TSTFP or TSTFC (EPAAct)	38	
A676	284/286T/TS	TEFC	B176206.00	\$1,140	TTFC	60	
A657	324/326T	TEFC	KIT 320TDFPA	\$1,288	TTFPA or TSTFPA	83	97
A658	324/326T/TS	TEFC	KIT 320TDFS	\$1,288	TTFS, TSTFS	118	
A677	324/326T/TS	TEFC	B176194.00	\$1,288	TTFC	98	
A637	364/365T	TEFC	KIT 360TDFC	\$1,520	TTFC (EPAAct)	121	
A678	364/365T/TS	TEFC	B176207.00	\$1,520	TTFC	121	

Complete kits with hardware necessary for converting Marathon stock C-Face rigid base motors to D-Flange mounting with rigid base.

CAT. NO.	FRAME	ENCLOSURE	KIT NO.	LIST PRICE	WHERE USED (MODELS CONTAINING)	WT.	FOOT NOTES
A630	182TC-184TC	TEFC	KIT 180TDFR	\$255	TTFR	17	
A631	284TC-286TC	TEFC	KIT 280TDFP	\$1,141	TTFP	15	
A632	324TC-326TC	TEFC	KIT 320TDFP	\$1,396	TTFP	71	
A634	405TC	TEFC	KIT 400TDFS	\$1,903	TTFS	149	

ACCESSORY KITS - MULTIPLIER SYMBOL S4

IEC MOUNTING KITS

Complete kits with hardware necessary for converting Marathon® IEC stock motors to B5 or B14 mountings.

FLANGE MOUNTING KITS FOR ALUMINUM FRAME MOTORS ONLY

FRAME	POLE	FLANGE	CAT. NO.	KIT NO.	LIST PRICE	BOLT CIRCLE "MM"	WT.
63	ALL	FF/B5	A569	KIT 635115	\$84	115	15
	ALL	FT/B14	A561	KIT 631475	\$77	75	15
71	ALL	FF/B5	A570	KIT 715130	\$99	130	15
	ALL	FT/B14	A562	KIT 711485	\$84	85	15
80	ALL	FF/B5	A571	KIT 805165	\$107	165	25
	ALL	FT/B14	A563	KIT 8014100	\$94	100	25
90	ALL	FF/B5	A572	KIT 905165	\$113	165	25
	ALL	FT/B14	A564	KIT 9014115	\$104	115	25

FLANGE MOUNTING KITS FOR CAST IRON FRAME, NEMA PREMIUM® (IE3) MOTORS ONLY

FRAME	POLE	FLANGE	CAT. NO.	KIT NO.	LIST PRICE	BOLT CIRCLE "MM"	WT.
100	ALL	FF/B5	A554A	KIT 175810	\$150	215	16
	ALL	FT/B14	A581A	KIT 175817	\$137	130	10
112	2 & 4	FF/B5	A555B	KIT 175827	\$161	215	33
	2 & 4	FT/B14	A582B	KIT 175832	\$150	130	13
	6	FF/B5	A554A	KIT 175810	\$150	215	33
	6	FT/B14	A581A	KIT 175817	\$137	130	13
132	2	FF/B5	A550	KIT 175828	\$214	265	20
	2	FT/B14	A589	KIT 175833	\$199	165	16
	4 & 6	FF/B5	A556A	KIT 175812	\$214	265	20
	4 & 6	FT/B14	A583A	KIT 175819	\$199	165	16
160	2	FF/B5	A551	KIT 175829	\$405	300	33
	2	FT/B14	A590	KIT 175834	\$422	215	30
	4 & 6	FF/B5	A557	KIT 175990	\$405	300	33
	4 & 6	FT/B14	A584	KIT 175991	\$491	215	30
180	2	FF/B5	A552	KIT 175830	\$553	300	41
	4 & 6	FF/B5	A558	KIT 175890	\$553	300	41
200	2	FF/B5	A553	KIT 175831	\$655	350	61
	4 & 6	FF/B5	A559	KIT 175994	\$655	350	61
225	2	FF/B5	A593	KIT 175837	\$2,317	400	59
	4 & 6	FF/B5	A580	KIT 175995	\$1,144	400	76
250	ALL	FF/B5	A594	KIT 175619	\$1,468	400	165
280	ALL	FF/B5	A596	KIT 175835	\$1,836	500	201
315	ALL	FF/B5	A598	KIT 175836	\$2,317	600	232

B14 METRIC FLANGES TO REDUCE DIAMETER FOR ALUMINUM FRAME MOTORS ONLY

FRAME	NEW FRAME DIAMETER	CAT. NO.	KIT NO.	KIT ONLY LIST PRICE	WT.
63	56	A585	KIT 175900	\$70	5
71	63	A586	KIT 175901	\$80	5
80	71	A587	KIT 175902	\$89	8
90	80	A588	KIT 175903	\$94	8

FLANGE MOUNTING KITS FOR CAST IRON FRAME, EPACT (IE2) MOTORS ONLY

FRAME	FLANGE	CAT. NO.	KIT NO.	LIST PRICE	BOLT CIRCLE "MM"	WT.	STYLE LETTER*
100	FF/B5	A573	KIT 1005215	\$150	215	16	None
	FF/B5	A554	KIT 175984	\$150	215	16	A
	FT/B14	A565	KIT 10014130	\$137	130	10	None
	FT/B14	A581	KIT 175985	\$137	130	10	A
112	FF/B5	A574	KIT 1125215	\$161	215	33	None
	FF/B5	A555	KIT 175986	\$161	215	33	A
	FT/B14	A566	KIT 11214130	\$150	130	13	None
	FT/B14	A582	KIT 175987	\$150	130	13	A
132	FF/B5	A575	KIT 1325265	\$214	265	20	None
	FF/B5	A556	KIT 175988	\$214	265	20	A
	FT/B14	A567	KIT 13214165	\$199	165	16	None
	FT/B14	A583	KIT 175989	\$199	165	16	A
160	FF/B5	A576	KIT 1605300	\$405	300	33	None
	FF/B5	A557	KIT 175990	\$405	300	33	A
	FT/B14	A568	KIT 16014215	\$390	215	30	None
	FT/B14	A584	KIT 175991	\$491	215	30	A
180	FF/B5	A577	KIT 1805300	\$502	300	33	None
	FF/B5	A558	KIT 175890	\$553	300	41	A
200	FF/B5	A578	KIT 2005350	\$655	350	45	None
	FF/B5	A559	KIT 175994	\$655	350	61	A
225	FF/B5	A579	KIT 2255400	\$838	400	60	None
	FF/B5	A580	KIT 175995	\$1,144	400	76	A

* Style letter refers to the 8th position in the motor model number. Ex: 132STFCA4526

TERMINAL BLOCK KITS

Terminal blocks provide for a convenient termination for power leads, and are sized for the proper amperage and voltage of the motor. These kits fit domestically produced NEMA® TEFC, TENV, and ODP motors equipped with cast iron conduit boxes. **Available on 182 to 449 frames.**

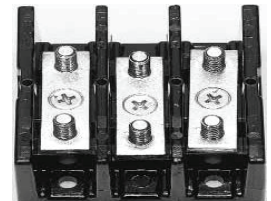

CAT. NO.	FRAME	KIT NO.	LIST PRICE	WT.
A1000	180-210	KIT 180-210 TERM BLK	\$161	2
A1001	250-320	KIT 250-320 TERM BLK	\$196	3
A1002	360	KIT 360 TERM BLK	\$268	5
A1003	405-445	KIT 400-445 TERM BLK	\$268	7
A1004	447/449	KIT 447/9 TERM BLK	\$387	10

All Kits Listed On This Page Are Stock

NEMA and NEMA Premium are trademarks of National Electrical Manufacturers Association. All Rights Reserved.

Prices and specifications are subject to change without notice.

ACCESSORY KITS - MULTIPLIER SYMBOL S4 (EXCEPT AS NOTED)

BRAKE KITS - SINGLE AND THREE PHASE MOTORS

STEARNS® 56000 SERIES BRAKE KITS

These kits include a brake mounted to an external cast aluminum fan guard. Designed for easy field installation on Marathon® 4-In-1® motors, 56, 143, and 145 frames only.

Selection Chart
(Used to select brake size)

TORQUE RATING (LB/FT)	LIST PRICE	115/208-230 VOLT		208-230/460 VOLT		575 VOLT		WT. ALL
		CAT. NO.	KIT. NO.	CAT. NO.	KIT. NO.	CAT. NO.	KIT. NO.	
3	\$634	A306	KIT 3BRK1	A301	KIT 3BRK3	A297	KIT 3BRK3A	10
6	\$747	A307	KIT 6BRK1	A302	KIT 6BRK3	A298	KIT 6BRK3A	11
10	\$924	—	—	A303	KIT 10BRK	A299	KIT 10BRKA	10

MOTOR HP	BRAKEMOTOR SHAFT RPM		
	LB-FT @ 3600	LB-FT @ 1800	LB-FT @ 1200
1/4	—	—	3
1/3	—	3	3
1/2	3	3	3
3/4	3	6	6
1	3	6	6
1 1/2	6	10	10
2	6	10	—

STEARNS 56000 SERIES BRAKE KITS - INVERTER DUTY TENV BLACK MAX® AND BLUE MAX® MOTORS - MULTIPLIER SYMBOL E3

For normal (140%) torque rating, do not apply on motors larger than 2 HP. Reduced braking torque and/or longer stopping times can result from applying an undersized brake on higher HP motors.

These brake kits fit on both the Black Max® and Blue Max® TENV motors. These can also be used together with the Double C-Face SL56 encoder to make a closed loop inverter brake motor.

TORQUE RATING (LB/FT)	LIST PRICE	115/208-230 VOLT		208-230/460 VOLT		575 VOLT		WT. ALL
		CAT. NO.	KIT. NO.	CAT. NO.	KIT. NO.	CAT. NO.	KIT. NO.	
6	\$1,140	A317	KIT BM6BRK115	A312	KIT BM6BRK	A315	KIT BM6BRK575	7
10	\$1,383	A318	KIT BM10BRK115	A313	KIT BM10BRK	A316	KIT BM10BRK575	7

See page 221 for encoder kits to install between the motor and brake.

VERTICAL MODIFICATION KIT (STEARNS 87,000 SERIES)

Includes required hardware to accommodate vertical above (shaft down) or vertical below (shaft up) mounting.

TORQUE RATING (LB/FT)	MOUNTING		CAT. NO.	KIT. NO.	LIST PRICE	WT. ALL
	SHAFT UP	SHAFT DOWN				
25,35	Not req'd	Required	A157	KIT VRT87BRK	\$669	3
50,75,105	Required	Required				



DOUBLE C-FACE COUPLER BRAKES

Includes a 5/8" sleeve

TORQUE RATING (LB/FT)	ENCLOSURE NEMA 2, IP-23 208-230/460V			ENCLOSURE NEMA® 4, IP-54 208-230/460V			ENCLOSURE NEMA 4X, IP-55 208-230/460V			WT. ALL
	CAT. NO.	KIT. NO.	LIST PRICE	CAT. NO.	KIT. NO.	LIST PRICE	CAT. NO.	KIT. NO.	LIST PRICE	
3	A903	KIT 903	\$845	A906	KIT 906	\$1,039	A909	KIT 909	\$1,203	12
6	A904	KIT 904	\$942	A907	KIT 907	\$1,173	A910	KIT 910	\$1,301	12
10	A905	KIT 905	\$1,073	A908	KIT 908	\$1,301	A911	KIT 911	\$1,430	12

All Kits Listed On This Page Are Stock

Stearns is believed to be the trademark or trade name of Rexnord Industries and is not owned or controlled by Regal Beloit Corporation.

NEMA is a trademark of National Electrical Manufacturers Association. All Rights Reserved.

Prices and specifications are subject to change without notice.

ACCESSORY KITS - MULTIPLIER SYMBOL S4

RESILIENT BASE

Includes base and latch straps. For use with motors having 2 1/4" resilient rings.



NEMA 48 FRAME, 2 1/4" DIA RINGS

CAT. NO.	KIT. NO.	LIST PRICE	SHELL LENGTH	FRAME SIZE	WT.
AG109	161L113AAG1	\$49	5.16	32	5
AG110	161L113AAG2	\$49	5.41	33	5
AG111	161L113AM-G6	\$49	5.79	35	5
AG112	161L113AAG4	\$49	6.22	36	5
AG113	161L113AAG5	\$49	6.62	37	5
AG114	161L113AAG6	\$49	7.22	38	5
AG115	161L113AAG9	\$49	7.75	39	5

RESILIENT BASE - MEMC

Used to add a resilient base to models having resilient rings. Results in 3" shaft height. Kit includes: mounting base and 2 latch assemblies.



CAT. NO.	KIT. NO.	LIST PRICE	RING TO RING DIMENSION	WT.
A107	KIT 107-637	\$19	6.37"	2

RESILIENT MOUNTING KIT

Used to add a resilient base to models having hubs only. 3-1/2" shaft height. Kit includes: mounting base, 2 resilient rings, 2 latch assemblies, 2 end caps and a slinger.



CAT. NO.	KIT. NO.	LIST PRICE	BASE LENGTH	USED WITH CAT. NO.	WT.
A279	KIT 279	\$33	8-5/8"	X500	5
A280	KIT 280	\$33	9-1/8"	X501, X511, X208	5
A281	KIT 281	\$75	11-5/8"	X507, X509	5
A282	KIT 282	\$65	10-5/8"	X503	5
A283	KIT 283	\$65	9-5/8"	X502, X207	5
A308	KIT 308	\$65	10-1/8"	X206	5

RESILIENT MOUNTING KIT

Fits 48 frame motors with 2-1/2" diameter resilient rings. Available in 3 sizes to fit 9", 10" and 12" blowers.

CAT. NO.	KIT. NO.	LIST PRICE	SIZE	WT.
A240	KIT 240	\$64	9"	5
A241	KIT 241	\$96	12"	5
A242	KIT 242	\$78	10"	5



NEMA 56 FRAME, 2 1/4" DIA RINGS

CAT. NO.	KIT. NO.	LIST PRICE	SHELL LENGTH	FRAME SIZE	WT.
AG125	161L113ADG1	\$49	5.41	33	5
AG127	161L113ADG3	\$49	6.22	36	5
AG128	161L113ADG4	\$49	6.62	37	5
AG129	161L113ADG5	\$49	7.22	38	5
AG130	161L113ADG14	\$49	7.75	39	5

6 1/2" DIA FAN & BLOWER REPLACEMENT MOTORS

CAT. NO.	KIT. NO.	LIST PRICE	SHELL LENGTH	FRAME SIZE	WT.
AG125	161L113ADG1	\$49	P243, P245	42	5
AG127	161L113ADG3	\$49	P244, P246, P180	49	5
AG128	161L113ADG4	\$49	P184, P185	46	5

SPLIT MOUNTING RINGS

Used for adapting a 2-1/4" Resilient mounting ring to 2-1/2". Kit includes: 4 split rings.



CAT. NO.	KIT. NO.	LIST PRICE	WT.
A104	KIT 104	\$13	1

RESILIENT RING KIT

Used to mount resilient rings onto hubbed PSC brackets. Kit includes: 2 rubber resilient rings and 4 split rings.



CAT. NO.	KIT. NO.	LIST PRICE	WT.	NOTES
A110	KIT 110	\$18	1	2-1/4" (48 frame)
A114	KIT 114	\$26	1	2-1/2" (56 frame)

RUBBER MOUNTING HARDWARE

Used for mounting the resilient base to a resilient ring. Kit includes: 4 clamps, 2 screws, and 2 nuts.



CAT. NO.	KIT. NO.	LIST PRICE	WT.	NOTES
A112	KIT 112	\$16	1	56 Frame
A113	KIT 113	\$16	1	48 Frame
AG195A	161L110AAG1	\$16	1	2 1/2" dia; 30 or 40
A518	161L110AA4	\$16	1	2 1/2" dia; 40

All Kits Listed On This Page Are Stock

Prices and specifications are subject to change without notice.

ACCESSORY KITS - MULTIPLIER SYMBOL S4

48 FRAME LUG MOUNTS KITS

A249
Single Strap,
Dual Slot
2" L, 1/4" & 3/4" W
\$56



A250
Double Strap,
Dual Slot
2" L, 1/4" & 3/4" W
\$56



A251
Double Strap,
Dual Slot
4" L, 1/4" & 3/4" W
\$56



A252
Single Strap,
Single Slot
2" L x 3/8" W
\$56



A253
Double Strap,
Single Slot
2" L x 3/8" W
\$56



A254
Double Wire,
Single Slot
2" L x 3/8" W
\$56



LENGTH ADAPTER KIT

Used to convert hubless motors to resilient ring mount. One adapter bracket can be mounted directly to original motor bracket and the other is mounted on the motor's thru-bolts and can be adjusted to desired length. Kit includes: 2 adapters, 2 resilient rings, 4 split rings, and the necessary nuts, screws, and washers.



CAT. NO.	KIT NO.	DESCRIPTION	LIST PRICE	WT.
A111	KIT 111	Two Adapters	\$32	1

BRAND R MOUNTING KIT

Used to replace a Brand R condenser fan motor where the original was held in place by four cables. Kit includes: pre-punched plated steel plate, 4-8x32 nuts with washer fastened, 4-10x32 nuts with washers fastened and 4-1/4" sheet metal screws. Instructions included.

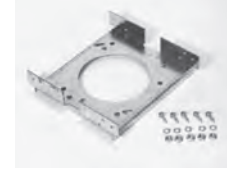

CAT. NO.	KIT NO.	LIST PRICE	WT.
A259	Kit 259	\$40	2



BRAND F MOUNTING KIT

Used in Brand F air conditioners.

CAT. NO.	KIT NO.	LIST PRICE	WT.
A277	KIT 277	\$40	2



OVAL RUN CAPACITORS

CAT. NO.	KIT NO.	SIZE	LIST PRICE	WT.
A965	111A271P113	208mfd/110v	\$19	2
A371	KIT 370-3	3mfd/370v	\$14	2
A372	KIT 370-4	4mfd/370v	\$14	2
A373	KIT 370-5	5mfd/370v	\$14	2
A375	KIT 370-7.5	7.5mfd/370v	\$18	2
A376	KIT 370-10	10mfd/370v	\$18	2
A378	KIT 370-15	15mfd/370v	\$30	2
A379	KIT 370-17.5	17.5mfd/370v	\$30	2
A380	KIT 370-20	20mfd/370v	\$33	2
A381	KIT 370-25	25mfd/370v	\$38	2
A382	KIT 370-30	30mfd/370v	\$43	2
A445	KIT 440-7.5	7.5mfd/440v	\$27	2
A446	KIT 440-10	10mfd/440v	\$30	2
A447	KIT 440-12.5	12.5mfd/440v	\$43	2
A448	KIT 440-15	15mfd/440v	\$43	2
A449	KIT 440-17.5	17.5mfd/440v	\$30	2

CAPACITOR MOUNTING KIT

Used for mounting a capacitor on the frame of a permanent split capacitor motors. Kit includes: mounting strap, mounting screws, and terminal protection boot. (4 screws are included - 2#10 screws and 2#8 screws). Fits 10mfd. and smaller capacitors only.



CAT. NO.	KIT NO.	LIST PRICE	WT.
A100	KIT 100	\$13	2

CAPACITOR WITH MOUNTING KIT

Kit includes 370 volt capacitor, mounting strap, mounting screws and terminal protection boot.

CAT. NO.	KIT NO.	SIZE	LIST PRICE	WT.
A243	KIT 243	5.0 mfd	\$26	2
A244	KIT 244	7.5 mfd	\$30	2
A245	KIT 245	10.0 mfd	\$33	2

BRAND F ADAPTER PLATE

Used to match Brand F rectangular mounting stud pattern on 5-5/8" motors.

CAT. NO.	KIT NO.	LIST PRICE	WT.
A278	KIT 278	\$21	3

ACCESSORY KITS - MULTIPLIER SYMBOL S4

CAPACITOR SELECTION GUIDE FOR STOCK PSC MOTORS

370 VOLT													440 VOLT				
3.0 MFD	4.0 MFD	5.0 MFD					7.5 MFD	10.0 MFD	15.0 MFD	17.5 MFD	20.0 MFD	25.0 MFD	30.0 MFD	7.5 MFD	10.0 MFD		
X411	X223	X001	X049	X081	X219	X430	X000	X294	X004	X453	X009	X433	X206	X462	X271	X454	X237
X427	X273	X003	X050	X082	X233	X440	X002	X413	X010	X458	X016		X447	X449	X448	X446	X241
X429	X281	X006	X052	X083	X234	X441	X005	X415	X021	X1010	X023		X242		X405		
		X011	X056	X086	X236	X442	X013	X422	X033		X027						
		X012	X057	X087	X258	X443	X015	X424	X035		X036						
		X014	X058	X088	X262	X445	X018	X426	X038		X039						
		X017	X059	X089	X278	X463	X020	X450	X063		X085						
		X019	X060	X097	X287	X464	X022	X456	X068		X090						
		X033	X061	X200	X295	X466	X037	X457	X084		X099						
		X034	X062	X202	X297	X470	X071	X465	X096		X205						
		X040	X064	X204	X412	X477	X203		X098		X207						
		X041	X065	X209	X417		X213		X208		X218						
		X042	X066	X210	X418		X214		X211		X298						
		X043	X067	X212	X419		X222		X221		X444						
		X044	X069	X215	X420		X225		X400		X452						
		X045	X070	X216	X423		X231		X414		X455						
		X048	X080	X217	X428		X283		X416		X459						
									X451								

SHAFT ADAPTER SLEEVE

Used to increase the diameter of a shaft to a larger size. Available sizes include converting from a 1/2" dia. shaft with flat to a 5/8" dia. with key and from a 5/8" dia. with key to a 3/4" dia. with key. Kit includes adapter sleeve and key.



CAT. NO.	KIT NO.	TO CHANGE SHAFT	LIST PRICE	WT.
A105	KIT 105	1/2" to 5/8"	\$13	3
A106	KIT 106	5/8" to 3/4"	\$18	3

SHAFT LOCK DEVICE

Used as a pry point for prying the blade off. Instructions included.



CAT. NO.	KIT NO.	LIST PRICE	WT.
A257	KIT 257	\$75	2

BLOWER WHEEL REMOVER

Used to pull off corroded, rusted, stubborn blower wheels from 5/8" diameter shafts and smaller. Comes with complete instructions.



CAT. NO.	KIT NO.	LIST PRICE	WT.
A256	KIT 256	\$236	2

TAPERED FORK

Used for prying off pulleys, fan blades, etc., from any shaft 5/8" diameter or smaller. Long 16" handle gives good leverage. Instructions included.



CAT. NO.	KIT NO.	LIST PRICE	WT.
A258	KIT 258	\$99	4

TOGGLE SWITCH

Start switches for single-phase open dripproof motors only in ratings one horsepower and smaller. Switch is mounted on the motor terminal box cover.



CAT. NO.	KIT NO.	LIST PRICE	WT.	NO. OF POLES	FRAME SIZE
AG228	112A515AKG4	\$59	2	Single (SPST)	30
AG229	112A515ASG2	\$59	2	Single (SPST)	40

All Kits Listed On This Page Are Stock

Prices and specifications are subject to change without notice.

ACCESSORY KITS - MULTIPLIER SYMBOL S4 (EXCEPT AS NOTED)

DRIP COVER KITS

Mounts with two screws into the end bracket. Kit includes: drip cover, mounting screws, washers, and instructions. Contact Regal to determine compatibility with motor. For vertical shaft down applications.

CAT. NO.	FRAME	KIT NO.	ENCLOSURE	LIST PRICE	WT.
A234	48-184T ("629")	KIT 234	ODP or TEFC	\$38	2
AG234	48-56	161L528AAG1	5K MDLS ODP	\$38	2
WD140DCOD	143/145T	Century	ODP (TO)	\$60	3
A201	182/184T	KIT 201	ODP	\$61	3
A662	182/184T	KIT 175614	ODP (TTDW)	\$123	15
WD180DCOD	182/184T	Century	ODP (TO)	\$61	3
A202	213/215T	KIT 202	ODP (TTDR)	\$75	5
A198	213/215T	KIT 198	ODP (TTDW)	\$75	5
A082	213/215T	B176222.00	ODP (TTDBD)	\$75	5
WD210DCOD	213/215T	Century	ODP (TO)	\$54	5
A311	254/256T	KIT 311	ODP (TTDX) Rigid Base	\$65	5
A083	254/256T	KIT 250DCD-WD	ODP (TTDBD)	\$523	5
A084	284/286T/TS	B176224.00	ODP (TTDBD)	\$709	8
WD280DCOD	284/286T/TS	Century	ODP (TO) Cast Iron	\$121	8
A085	324/326T/TS	B176225.00	ODP (TTDBD)	\$820	8
WD320DCOD	324/326T/TS	Century	ODP (TO) Cast Iron	\$145	8
A086	364/365T/TS	B176226.00	ODP (TTDBD)	\$912	15
WD360DCOD	364/365T/TS	Century	ODP (TO) Cast Iron	\$218	15
A087	404/405T/TS	B176227.00	ODP (TTDBD)	\$1,013	18
WD400DCOD	404/405T/TS	Century	ODP (TO) Cast Iron	\$242	18
A088	444/449T/TS	B176228.00	ODP (TTDBD)	\$1,151	18
WD440DCOD	444/449T/TS	Century	ODP (TO) Cast Iron	\$326	18
WD140DCF	143/145T	Century	TEFC (TE, SD) & (TTFB)	\$60	3
A197	182/184T	KIT 197	TEFC (4-IN-1)	\$196	3
A091	182/184T	B176241.00	TEFC (TTFCD)	\$196	3
WD180DCF	182/184T	Century	TEFC (TE, SD) & (TTFBA, TTFCA)	\$109	3
A199	213/215T	KIT 199	TEFC (4-IN-1)	\$210	5
A092	213/215T	B176214.00	TEFC (TTFCD)	\$405	5
WD210DCF	213/215T	Century	TEFC (TE, SD) & (TTFCA)	\$142	5
A093	254/256T	B176215.00	TEFC (TTFCD)	\$650	5
WD250DCF	254/256T	Century	TEFC (TE, SD) & (TTFCA)	\$145	5
A094	284/286T/TS	KIT 280DCF-WD	TEFC (TTFCA or TTFCD)	\$681	8
WD280DCF	284/286T/TS	Century	TEFC (TE, SD) & (TTFCA)	\$168	8
A095	324/326T/TS	B176217.00	TEFC (TTFCD)	\$694	8
WD320DCF	324/326T/TS	Century	TEFC (TE, SD) & (TTFCA)	\$200	8
A096	364/365T/TS	B176218.00	TEFC (TTFCD)	\$753	15
WD360DCF	364/365T/TS	Century	TEFC (TE, SD) & (TTFCA)	\$313	15
A097	404/405T/TS	B176219.00	TEFC (TTFCD)	\$923	18
WD400DCF	404/405T/TS	Century	TEFC (TE) & (TTFCA)	\$353	18
A098	444/445T/TS	B176220.00	TEFC (TTFCD)	\$1,105	18
WD440DCF	444/449T/TS	Century	TEFC (TE) & (TTFCA)	\$608	18
A099	447/449T/TS	B176221.00	TEFC (TTFCD)	\$970	18

Note: Kit 234, the mounting holes have a 4.80 bolt circle.

MOTOR RAINSHIELD/FAN CANOPY

Sizes to fit 1/2" or 5/8" diameter shafts. 6.88" diameter. Shield has 8 air vanes to provide air circulation for motor. For vertical shaft up applications. Rain shield mounts over shaft.



056 TYPE MODEL NUMBERS

CAT. NO.	KIT NO.	LIST PRICE	WT.	SHAFT DIA.
A247	KIT 247	\$13	2	1/2"
A248	KIT 248	\$13	2	5/8"



5K TYPE MODEL NUMBERS

CAT. NO.	KIT NO.	LIST PRICE	WT.	WHERE USED
A549	52A101229AAG1	\$91	2	5.5" Dia. Motors, 1/2" shaft dia.

Includes clamp and black plastic cover.

ACCESSORY KITS - MULTIPLIER SYMBOL S4

BRASS PUNCH

Used for placing between your hammer and a motor's shaft or bearing. 3/4" diameter x 6" length.

CAT. NO.	KIT NO.	LIST PRICE	WT.
A261	KIT 261	\$33	6



CONDUIT BOX KIT

(56/140 FRAME EXPLOSION PROOF MOTORS)

For installation on rolled steel 56/140 frame explosion proof motors. Lead exit holes are 1" dia. NPT.

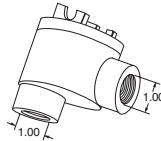

CAT. NO.	KIT NO.	LIST PRICE	WT.
A800	KIT 56 EXPR BOX	\$148	2

LEAD EXIT REDUCERS

(56/140 FRAME EXPLOSION PROOF MOTORS)

For reducing the lead exit from 1" to 3/4". Kit LDRDCR-M has an externally threaded 3/4" exit and internally threaded 1" exit.

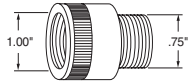

CAT. NO.	KIT NO.	LIST PRICE	WT.
A803	KIT LDRDCR-M	\$27	2

CAST IRON CONDUIT BOX KITS

Fits standard Globetrotter® and Blue Chip Series® motors. Threaded conduit box and gaskets.

CAT. NO.	FRAME	KIT NO.	ENCLOSURE	LIST PRICE	WT.
A720	182-215T	KIT 180/210CB	TTFS, TTFN or TTFND	\$128	4
A933	182/184T	B176242.00	TTFCD	\$317	
A722	254/256T	KIT 250CB	TTFS, TTFN, TTFNA, or TTFPA	\$210	12
A935	254/256T	B176209.00	TTFCD	\$486	
A729	284/286T/TS	KIT 280CB	TTFN, TTFNA, TTFP, or TTFPA	\$284	12
A936	284/286T/TS	B176210.00	TTFCD	\$548	
A730	324/326T/TS	KIT 320CB	TTFS, TTFN, TTFP, or TTFPA	\$316	28
A937	324/326T/TS	B176211.00	TTFCD	\$633	
A119	364/445T/TS	KIT 364-445CB	TTFS, TTFN,	\$531	34
A938	364/365T/TS	B176212.00	TTFCD	\$1,066	
A939	404/449T/TS	B176213.00	TTFCD	\$1,371	

FAN GUARD KITS

Fits standard Globetrotter motors. Mounts with four screws into the end bracket.

Kit includes: fan guard, mounting screws, washers, and instructions.

CAT. NO.	FRAME	KIT NO.	ENCLOSURE	LIST PRICE	WT.
A972	182/184T	B176237.00	TTFCD	\$72	3
A973	213/215T	B176238.00	TTFCD	\$120	3
A974	254/256T	B176239.00	TTFCD	\$151	3
A975	143/145T	—	TTFCD	\$215	8
A976	182/184T	B176243.00	TTFCD	\$317	20
A977	213/215T	—	TTFCD	\$406	25
A978	254/256T	—	TTFCD	\$486	38
A979	284/286T/TS	—	TTFCD	\$548	40
A980	324/326T/TS	B176196.00	TTFCD	\$633	55
A981	364/365T/TS	B176197.00	TTFCD	\$849	105
A982	404/405T/TS	B176198.00	TTFCD	\$955	175
A983	444/445T/TS	B176199.00	TTFCD	\$1,012	225
A984	447/449T/TS	B176200.00	TTFCD	\$1,149	250

All Kits Listed On This Page Are Stock

Prices and specifications are subject to change without notice.

ACCESSORY KITS - MULTIPLIER SYMBOL S4

5K MOTOR ACCESSORIES

CAT. NO.	KIT NO.	DISCRIPTION	LIST PRICE	WT.
A940	52D310833AAP001	30 Frame C-face PE Endshield	\$33	4
A941	52D311808ARP1	40 Frame C-face PE Endshield	\$62	4
A942	52D310814AAP1	30 Frame OPE Endshield	\$24	4
A945	115D964P1	Base Plate for 30 Frame	\$13	2
A946	115D964P2	Base Plate for 40 Frame	\$13	2
A947	115D963P1	Back Compartment Cover	\$13	2
A948	113A617AG001	OPE bearing 17 mm	\$14	3
A949	113A620AYP1	PE bearing 20 mm	\$33	3
A950	976B399AAP9	Run Capacitor 15mfd/370v	\$38	2
A951	976B399AAP12	Run Capacitor 22.5mfd/370v	\$45	2
A952	976B399AAP13	Run Capacitor 25mfd/370v	\$46	2
A953	976B399ABP6	Run Capacitor 40mfd/370v	\$62	2
A954	976B399ABP9	Run Capacitor 45mfd/370v	\$56	2
A955	976B399ABP10	Run Capacitor 50mfd/370v	\$46	2
A956	161L198AAG9	Switch for Single Speed Models	\$14	1
A957	161L198AAG10	Switch for Two Speed Models	\$27	2
A958	161L197ABG1	Start mech for Single Speed Models	\$6	1
A959	161L197ABG11	Start mech for Two Speed Models	\$13	1
A960A	3062.09	Start Capacitor 161-193mfd/110v	\$19	2
A961	111A271P111	Start Capacitor 40mfd/220v	\$19	2
A962	52D310822ACDP1	30 Frame Square Flange PE Endshield	\$32	4
A963	52D311819ABP1	40 Frame Square Flange PE Endshield	\$62	4
A964	52A103486G1	Voltage Changing Plug	\$5	2

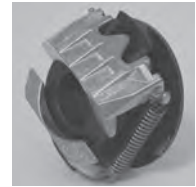

PUMP MOTORS RAINSHIELD KIT

Designed for horizontally mounted pump motors to adhere to UL1081 standard. Includes screw and rain cover.

CAT. NO.	KIT NO.	WHERE USED	LIST PRICE	WT.
AG697	161L210AAP1	5" & 5 1/2" Dia. Motors	\$91	1



SEVERE DUTY - UPGRADE TO CAST IRON FAN COVER / CONDUIT BOX

Fits standard Blue Chip Series® motors to achieve all cast iron construction. Components include fan guard and threaded conduit box.

CAT. NO.	KIT NO.	LIST PRICE	FRAME	WT.	WHERE USED
A715	KIT 140CB	\$175	143T-145T	4	TTTN
A718	KIT 180R	\$252	182T-184T	17	THFN, THFS, THTS, TTFC (Not XRI), TTFN, TTFS, TTTS
A721	KIT 210R	\$367	213T-215T	19	THFS, THTS, TTFC (Not XRI), TTFS, TTTS
A723	KIT 250RFPA	\$445	254T-256T	32	TTFPA, or THFPA
A724	KIT 250RFNA	\$445	254T-256T	34	TTFNA, TTFCA (Not XRI), THTNA, or THFNA
A725	KIT 250R	\$445	254T-256T	32	TTFC (Not XRI)
A726	KIT 280RFPA	\$618	284T-286T	34	TTFPA, TSTFPA, or TSHFPA
A727	KIT 280RFN	\$618	284T-286T	39	TTFN or TSTFN
A728	KIT 280R	\$618	284T-286T	39	TTFC (Not XRI) or TTFF
A731	KIT 280RFNA	\$618	284T-286T	32	TTFNA, TSTFNA, THFNA or TSHFNA
A733	KIT 320RFPA	\$655	324T-326T	55	TTFPA, TSTFPA, THFPA, or TSHFPA

ACCESSORY KITS - MULTIPLIER SYMBOL S4

BALL BEARING CONVERSION KITS

For conversion of roller bearing on drive end to ball bearing (for direct-coupled applications).

CONFIRM KIT SELECTION WITH CUSTOMER SERVICE/ENGINEERING

CAT. NO.	KIT NO.	LIST PRICE	FRAME	BEARING SIZE	ENCLOSURE	WT.	WHERE USED (MODELS CONTAINING)
A760	KIT 440BBFN	\$2,438	444T-445T	318	TEFC	160	TTFN, THFN
A761	KIT 449BBFS	\$2,537	447T-449T	319	TEFC	171	TTFS, THFS
A788	KIT 449BBFS-319	\$2,537	L447T-L449T	319	TEFC	174	TTFS
A787	KIT 449BBFS-322	\$2,537	447T-449T	322	TEFC	196	TTFS
A795	KIT L449BBFS-322	\$2,537	L447T-L449T	322	TEFC	190	TTFS

ROLLER BEARING CONVERSION KITS

For conversion of roller bearing on drive end to ball bearing (for belted applications).

CONFIRM KIT SELECTION WITH CUSTOMER SERVICE/ENGINEERING

CAT. NO.	KIT NO.	LIST PRICE	FRAME	ENCLOSURE	WT.	WHERE USED (MODELS CONTAINING)
A755	KIT 360BRFSR-314	\$1,855	364T-365T	TEFC & TEBC	14	TTFS, THFS
A756	KIT 400BRFS-316	\$1,855	404T-405T	TEFC & TEBC	19	TTFS, THFS
A757	KIT 440BRFS-318	\$2,438	444T-445T	TEFC & TEBC	32	TTFS, THFS
A759	KIT 440BRFN	\$2,438	444T-445T	TEFC & TEBC	13	TTFN, THFN
A758	KIT 449BRFS	\$2,537	447T-449T	TEFC & TEBC	20	TTFS, THFS

AXIAL BLOWER KITS

For installation on Blue Chip Series® XRI® Totally Enclosed and Severe Duty motors (excluding Explosion Proof).

CAT. NO.	KIT NO.	LIST PRICE	FRAME	WT.	WHERE USED (MODELS CONTAINING)
A680	4900030	\$1,032	1HP Motor Only	56	Replacement motor for TEBC blower unit
A681A	4900670	\$1,074	2HP Motor Only	57	Replacement motor for TEBC blower unit
A692	KIT 21TEBC	\$2,560	213T-215T	104	TTFS
A691	KIT 25TEBCNA	\$2,797	254T-256T	158	TTFNA (Also fits 284/286T/TS TTFPA)
A701	KIT 28TEBCNA	\$3,293	284T/TS-286T/TS	103	TTFNA
A695	KIT 32TEBC	\$3,873	324T/TS-326T/TS	200	TTFS
A696	KIT 36TEBC	\$4,960	364T/TS-365T/TS	172	TTFS
A697	KIT 40TEBC	\$5,835	404T/TS-405T/TS	242	TTFS
A698	KIT 44TEBC-313	\$6,185	444TS-449TS	401	A 6313 bearing on opposite shaft end
A699	KIT 44TEBC-316	\$6,185	444T-449T	401	A 6316 bearing on opposite shaft end (excludes roller bearing)
A700	KIT 44TEBC-318	\$6,185	444T-449T	401	A 6318 bearing on opposite shaft end (excludes roller bearing)
A796	KIT L449TEBC	\$6,185	L447T-L449T	272	With L447/449 Frames

All Kits Listed On This Page Are Stock

Prices and specifications are subject to change without notice.

ACCESSORY KITS - MULTIPLIER SYMBOL E3

ENCODER KITS AND ACCESSORIES FOR BLACK MAX®, BLUE MAX®, XRI®-SD AND XRI-841 MOTORS

Installation of encoder kits on Blue Chip Series® XRI-SD and XRI-841 TEFC motors requires installation of A807 Stub Shaft Kit (see below)

ENCL.	FRAME	BRAND / MODEL	PPR.	CAT. NO.	KIT NO.	LIST PRICE	WT.	NOTES		
TENV (5/8" bore)	56-286	Avtron® AV32	1024	A1010	KIT AV321024-NV	\$1,594	1	Shaft Mount, 5-24 VDC, with 10 pin connector/mate		
				A972	KIT AV32B1024-NV			Shaft Mount, 5-24 VDC, with 10 pin connector/mate (BEI Phased)		
			2048	A1011	KIT AV322048-NV	\$1,594	1	Shaft Mount, 5-24 VDC, with 10 pin connector/mate		
				A973	KIT AV32B2048-NV			Shaft Mount, 5-24 VDC, with 10 pin connector/mate (BEI Phased)		
		Avtron HS35A	1024	A736	KIT HS35A1024-NV	\$2,305	4	Shaft Mount, 5-26 VDC, with 10 pin connector/mate		
				A779A	KIT HS35A/B1024-NV			Shaft Mount, 5-26 VDC, with 10 pin connector/mate (REPLACES BEI A779)		
			2048	A739	KIT HS35A2048-NV			Shaft Mount, 5-26 VDC, with 10 pin connector/mate		
				A780A	KIT HS35A/B2048-NV			Shaft Mount, 5-26 VDC, with 10 pin connector/mate (REPLACES BEI A780)		
		Avtron HS35M	1024	A742	KIT HS35M1024	\$2,668	4	Shaft Mount, 5-24 VDC, with EPIC connector/mate		
		Avtron HS45	1024	A753A	KIT HS451024-NV	\$4,463	10	Shaft Mount, 5-24 VDC, with EPIC connector/mate		
		Avtron AV56	512	A713	KIT AV56512-NV	\$3,639	5	Modular Mount, 5-24 VDC, with EPIC connector/mate, Double C-Face		
			1024	A793A	KIT AV561024-NV	\$3,639	5	Modular Mount, 5-24 VDC, with EPIC connector/mate, Double C-Face		
		Dynapar® HS20	1024	A687	KIT HS201024-NV	\$1,071	3	Shaft Mount, 5-26 VDC, with 10 pin connector/mate		
		Dynapar HS35R	1024	A772	KIT HS351024-NV	\$2,305	3	Shaft Mount, 5-26 VDC, with 10 pin connector/mate		
			2048	A776	KIT HS352048-NV			Shaft Mount, 5-26 VDC, with EPIC connector/mate		
		NorthStar® HSD35	1024	A711	KIT HSD351024-NV	\$2,489	4	Modular Mount, 5-15 VDC, with EPIC connector/mate		
		NorthStar ST56	512	A785	KIT LKSR512	\$3,639	5	Modular Mount, 5-15 VDC, with EPIC connector/mate		
			1024	A763	KIT LKSR02	\$3,639	5	Modular Mount, 5-15 VDC, with EPIC connector/mate, Double C-Face		
1024	A786		KIT LKSR-CFACE	\$4,000	5	Modular Mount, 5-15 VDC, with EPIC connector/mate, Double C-Face				
TEFC (1" bore)	182-449	Avtron AV32	1024	A974	KIT AV321024-FC	\$1,594	1	Shaft Mount, 5-24 VDC, with 10 pin connector/mate		
				A976	KIT AV32B1024-FC			Shaft Mount, 5-24 VDC, with 10 pin connector/mate (BEI Phased)		
			2048	A975	KIT AV322048-FC	\$1,594	1	Shaft Mount, 5-24 VDC, with 10 pin connector/mate		
				A977	KIT AV32B2048-FC			Shaft Mount, 5-24 VDC, with 10 pin connector/mate (BEI Phased)		
		Avtron HS35A	1024	A737	KIT HS35A1024-FC	\$2,305	4	Shaft Mount, 5-26 VDC, with 10 pin connector/mate		
				A783A	KIT HS35A/B1024-FC			Shaft Mount, 5-26 VDC, with 10 pin connector/mate (REPLACE BEI A783)		
			2048	A740	KIT HS35A2048-FC			Shaft Mount, 5-26 VDC, with 10 pin connector/mate		
				A784A	KIT HS35A/B2048-FC			Shaft Mount, 5-26 VDC, with 10 pin connector/mate (REPLACE BEI A784)		
		Avtron HS35M	1024	A742	KIT HS35M1024	\$2,668	4	Shaft Mount, 5-24 VDC, with EPIC connector/mate		
		Avtron HS45	1024	A754A	KIT HS451024-FC	\$4,463	10	Shaft Mount, 5-24 VDC, with EPIC connector/mate		
		Dynapar HS35R	1024	A774	KIT HS35M2048	\$2,383	4	Shaft Mount, 5-24 VDC, with EPIC connector/mate		
			2048	A744	KIT HS35M2048	\$2,383	4	Shaft Mount, 5-24 VDC, with EPIC connector/mate		
		Avtron HS45	1024	A754A	KIT HS451024-FC	\$4,463	10	Shaft Mount, 5-24 VDC, with EPIC connector/mate		
		Dynapar HS35R	1024	A774	KIT HS351024-FC	\$2,305	3	Shaft Mount, 5-26 VDC, with 10 pin connector/mate		
			2048	A777	KIT HS352048-FC			Shaft Mount, 5-26 VDC, with 10 pin connector/mate		
		NorthStar HSD35	1024	A712	KIT HSD351024-FC	\$2,489	4	Shaft Mount, 5-26 VDC, with EPIC connector/mate		
		TEBC (1" bore)	284-449	Avtron AV32	1024	A974	KIT AV321024-FC	\$1,594	1	Shaft Mount, 5-24 VDC, with 10 pin connector/mate
						A976	KIT AV32B1024-FC			Shaft Mount, 5-24 VDC, with 10 pin connector/mate (BEI Phased)
2048	A975				KIT AV322048-FC	\$1,594	1	Shaft Mount, 5-24 VDC, with 10 pin connector/mate		
	A977				KIT AV32B2048-FC			Shaft Mount, 5-24 VDC, with 10 pin connector/mate (BEI Phased)		
Avtron HS35A	1024			A738	KIT HS35A1024-BC	\$2,305	3	Shaft Mount, 5-26 VDC		
Avtron AV56	1024			A794A	KIT AV561024-BC	\$4,048	4	Shaft Mount, 5-24 VDC		
Dynapar HS35R	1024			A775	KIT HS351024-BC	\$2,305	3	Shaft Mount, 5-26 VDC		
	2048			A778	KIT HS352048-BC			Shaft Mount, 5-26 VDC		
NorthStar ST56	1024			A764	KIT LKSR03	\$3,639	5	Modular Mount, 5-15 VDC		
Turck® A02H	1024			A668	KIT A02H1024-BC LED	\$2,588	4	Shaft Mount, 5-30VDC, bulkhead (A801 not required), LED cordset (3m)		
	2048			A669	KIT A02H2048-BC LED			Shaft Mount, 5-30VDC, bulkhead (A801 not required), LED cordset (3m)		
ALL				A801	KIT ENCBOX	\$243	2	Encoder Conduit Box (required for all TEBC encoders except Turck A02H)		
TENV Brake Motors	143-256	Avtron AV56	1024	A748A	KIT AV561024BRK-140	\$3,639	4	Fits Blue Max Brakemotors (Y986, Y987)		
				A749A	KIT AV561024BRK-182			Fits Blue Max Brakemotors (Y988)		
			Avtron AV85	1024	A750A	KIT AV851024BRK-184	\$4,909	8	Fits Blue Max Brakemotors (Y989)	
		A751A			KIT AV851024BRK-210	Fits Blue Max Brakemotors (Y990, Y991)				
		NorthStar ST56	1024	A752A	KIT AV851024BRK-250	\$4,000	5	Fits Blue Max Brakemotors (Y992, Y993)		
				A786	KIT LKSR-CFACE			Fits Blue Max Brakemotors (Y986, Y987)		
		NorthStar ST85	1024	A789	KIT ST561024-182NV	\$4,909	8	Fits Blue Max Brakemotors (Y988)		
				A790A	KIT ST851024-184NV			Fits Blue Max Brakemotors (Y989)		
				A791A	KIT ST851024-210NV			Fits Blue Max Brakemotors (Y990, Y991)		
		A792A	KIT ST851024-250NV	Fits Blue Max Brakemotors (Y992, Y993)						
CABLE KITS	56-449	Danaher® Controls	N/A	A688-10	KIT A688-10	\$444	3	10' cable and pre-wired 10-pin connector for all 10 pin (MS) connectors		
			N/A	A688-20	KIT A688-20	\$627	3	20' cable and pre-wired 10-pin connector for all 10 pin (MS) connectors		
			N/A	A688-25	KIT A688-25	\$710	4	25' cable and pre-wired 10-pin connector for all 10 pin (MS) connectors		
			N/A	A688-30	KIT A688-30	\$800	4	30' cable and pre-wired 10-pin connector for all 10 pin (MS) connectors		
			N/A	A688-50	KIT A688-50	\$1,155	5	50' cable and pre-wired 10-pin connector for all 10 pin (MS) connectors		
			N/A	A688-60	KIT A688-60	\$1,332	5	60' cable and pre-wired 10-pin connector for all 10 pin (MS) connectors		
			N/A	A688-100	KIT A688-100	\$2,040	10	100' cable and pre-wired 10-pin connector for all 10 pin (MS) connectors		
			N/A	A690-15	KIT A690-15	\$368	3	15 feet bulk cable, for use with NorthStar encoders		

All Kits Listed On This Page Are Stock

Avtron is believed to be a trademark of Avtron Mfg. and is not owned or controlled by Regal Beloit Corporation.
 Dynapar and Danaher are believed to be trademarks of Danaher Corporation. and is not owned or controlled by Regal Beloit Corporation.
 Northstar is believed to be a trademark of Northern Tool & Equipment. and is not owned or controlled by Regal Beloit Corporation.
 Turck is believed to be the trademark or trade name of Turck Corporation and is not owned or controlled by Regal Beloit Corporation.

Prices and specifications are subject to change without notice.

ACCESSORY KITS - MULTIPLIER SYMBOL E3

ENCODER STUB SHAFT KIT

Fits XRI® Severe Duty or XRI IEEE-841 motors to allow the addition of 1" borehollow shaft encoders on opposite drive end of motor.

CAT. NO.	KIT NO.	LIST PRICE	FRAME	WT.	WHERE USED
A807	KIT STUBSHAFT 1IN	\$268	182T-449T/TS	3	FAN COOLED SEVERE DUTY AND IEEE-841

WARNING:

Encoder stub shaft may not be installed on motors used in Division 1 or Division 2 hazardous locations.



SHAFT GROUNDING KITS

Shaft grounding: Shaft grounding is recommended (NEMA® MG1 31.4.4.3) as an effective means of bearing protection for motors operated from inverter power. One grounding device is adequate to bleed down inverter-sourced shaft voltages, thereby protecting both bearings for motors as large as 6085 frame.

BCP KIT:

Kit includes grounding ring, adhesive mounting hardware and instructions (for domestic produced products only).

BCP UNIVERSAL KIT:

Kit includes grounding ring, all mounting hardware needed to mount to any standard drive end bracket and instructions.



BCP UNIVERSAL SPLIT RING KIT

Kit is designed to allow BCP mounting without uncoupling the motor. Kit includes grounding ring, all mounting hardware needed to mount to any standard drive end bracket and instructions. Shaft ground rings fit these NEMA frame shaft extensions listed below, they are designed to mount on the shaft end. For larger frames, please contact Regal.

BCP KIT					BCP UNIVERSAL KIT				BCP UNIVERSAL SPLIT RING KIT			
FRAME	KIT NO.	CAT. NO.	LIST PRICE	WT.	KIT NO.	CAT. NO.	LIST PRICE	WT.	KIT NO.	CAT. NO.	LIST PRICE	WT.
48	KIT SGR-11.2	A500-5	\$347	1	—	—	—	—	—	—	—	—
56	KIT SGR-14.4	A500-8	\$347	1	KIT SGR-0.625-UK	A499-1	\$539	5	KIT SGR-0.625-1A4-UK	A495-1	\$858	5
143-145T	KIT SGR-20.7	A500-14	\$370	1	KIT SGR-0.875-UK	A499-2	\$582	5	KIT SGR-0.875-1A4-UK	A495-2	\$939	5
182-184T	KIT SGR-27.1	A500-20	\$402	1	KIT SGR-1.125-UK	A499-3	\$623	5	KIT SGR-1.125-1A4-UK	A495-3	\$1,030	5
213-215T	KIT SGR-33.4	A500-26	\$453	1	KIT SGR-1.375-UK	A499-4	\$665	5	KIT SGR-1.375-1A4-UK	A495-4	\$1,091	5
254-256T	KIT SGR-39.8	A500-32	\$559	1	KIT SGR-1.625-UK	A499-5	\$832	5	KIT SGR-1.625-1A4-UK	A495-5	\$1,334	5
250JM/JP	KIT SGR-43.0	A500-35	\$547	1	—	—	—	—	—	—	—	—
284-286T	KIT SGR-46.1	A500-38	\$668	1	KIT SGR-1.875-UK	A499-6	\$915	5	KIT SGR-1.875-1A4-UK	A495-6	\$1,456	5
284-286TS	KIT SGR-39.8	A500-32	\$559	1	KIT SGR-1.625-UK	A499-5	\$832	5	KIT SGR-1.625-1A4-UK	A495-5	\$1,334	5
324-326T	KIT SGR-52.5	A500-44	\$773	1	KIT SGR-2.125-UK	A499-7	\$1,041	7	KIT SGR-2.125-1A4-UK	A495-7	\$1,608	7
324-326TS	KIT SGR-46.1	A500-38	\$668	1	KIT SGR-1.875-UK	A499-6	\$915	5	KIT SGR-1.875-1A4-UK	A495-6	\$1,456	5
364-365T	KIT SGR-58.8	A500-50	\$878	1	KIT SGR-2.375-UK	A499-8	\$1,125	7	KIT SGR-2.375-1A4-UK	A495-8	\$1,739	7
364-365TS	KIT SGR-46.1	A500-38	\$668	1	KIT SGR-1.875-UK	A499-6	\$915	5	KIT SGR-1.875-1A4-UK	A495-6	\$1,456	5
404-405T	KIT SGR-71.5	A500-62	\$1,299	1	KIT SGR-2.875-UK	A499-9	\$1,458	7	KIT SGR-2.875-1A4-UK	A495-9	\$2,088	7
404-405TS	KIT SGR-52.5	A500-44	\$773	1	KIT SGR-2.125-UK	A499-7	\$1,041	7	KIT SGR-2.125-1A4-UK	A495-7	\$1,608	7
444-445T	KIT SGR-84.2	A500-74	\$1,862	1	KIT SGR-3.375-UK	A499-10	\$1,960	7	KIT SGR-3.375-1A4-UK	A495-10	\$2,621	7
444-445TS	KIT SGR-58.8	A500-50	\$878	1	KIT SGR-2.375-UK	A499-8	\$1,125	7	KIT SGR-2.375-1A4-UK	A495-8	\$1,739	7
447/449T	KIT SGR-84.2	A500-74	\$1,862	1	KIT SGR-3.375-UK	A499-10	\$1,960	7	KIT SGR-3.375-1A4-UK	A495-10	\$2,621	7
447/449TS	KIT SGR-58.8	A500-50	\$878	1	KIT SGR-2.375-UK	A499-8	\$1,125	7	KIT SGR-2.375-1A4-UK	A495-8	\$1,739	7
5000LS	KIT SGR-71.5	A500-62	\$1,299	1	—	—	—	—	KIT SGR-4.875-1A4-UK	A495-14	\$3,990	7

CONDUCTIVE EPOXY:

Epoxy comes in two 7g syringes, 14g (0.35 oz). This two part epoxy offers high electrical conductivity and strong conductive bonding. Use in place of traditional end bracket drilling.

CAT. NO.	KIT NO.	LIST PRICE	WT.
A496	EP2400	\$814	2

REPLACEMENT GROUND BRUSH MOUNTING HARDWARE AND BRUSHES

CAT. NO.	KIT NO.	LIST PRICE	WT.	COMMENTS
A103	KIT 103	\$556	1	Drive end mount
A116	KIT 116	\$803	1	Non-drive end mount
A109	KIT 109	\$88	1	Replacement brush

WARNING:

Grounding devices may not be installed on motors used in Division 1 or Division 2 hazardous locations.

All Kits Listed On This Page Are Stock

NEMA is a trademark of National Electrical Manufacturers Association. All Rights Reserved.

Prices and specifications are subject to change without notice.

ACCESSORY KITS - MULTIPLIER SYMBOL S4

TRANSITION BASES

APPLICATION:

Convert "T" frame ratings to "U" frame based dimensions and shaft heights. Shaft dimensions may vary from actual "U" frame specifications.

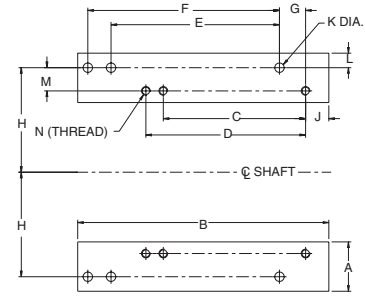

Dimensions = Inches

CAT. NO.	KIT NO.	CONVERTS		A	B	HGT	C	D	E	F	G	H	J	K	L	M	N (THREAD)	APP. WT.	LIST PRICE
		FROM	TO																
1814T	KIT 180U	143/5T	182/4	2 1/4	7 1/2	1	4	5	4 1/2	5 1/2	1/2	3 3/4	1	7/16	1/2	1	5/16-18	2	\$234
2118T	KIT 210U	182/4T	213/5	1 3/4	9 1/2	3/4	4 1/2	5 1/2	5 1/2	7	1	4 1/4	1	7/16	7/16	1/2	3/8-16	3	\$296
25U21T	KIT 250U	213/5T	254/6U	2 7/16	12 3/4	1	5 1/2	7	8 1/4	10	1 1/8	5	1	9/16	5/8	3/4	3/8-16	5	\$296
28U25T	KIT 280U	254/6T	284/6U	2 3/4	14 1/4	3/4	8 1/4	10	9 1/2	11	1 3/8	5 1/2	1 1/4	9/16	15/16	1/2	1/2-13	8	\$296
32U28T	KIT 320U	284/6T	324/6U	3 1/4	15 3/4	1	9 1/2	11	10 1/2	12	1 1/2	6 1/4	1 1/2	11/16	15/16	3/4	1/2-13	10	\$351
36U32T	KIT 360U	324/6T	364/5U	3 11/16	16 1/2	1	10 1/2	12	11 1/4	12 1/4	1 3/4	7	1 3/4	11/16	1 3/16	3/4	5/8-11	13	\$414
40U36T	KIT 400U	364/5T	404/5U	4 1/4	18 5/8	1	11 1/4	12 1/4	12 1/4	13 3/4	2	8	2	13/16	1 1/4	1	5/8-11	22	\$531
44U40T	KIT 440U	404/5T	444/5U	4 1/4	21 5/8	1	12 1/4	13 3/4	14 1/2	16 1/2	2 1/4	9	2	13/16	1 1/4	1	3/4-10	24	\$531

ADJUSTABLE MOTOR BASES (SLIDE BASES)

APPLICATION:

Used to adjust tension during motor installation. Made with heavy duty steel construction with single screw adjustment for 143T-215T Frame and double screw adjustment for 254T Frame and larger.

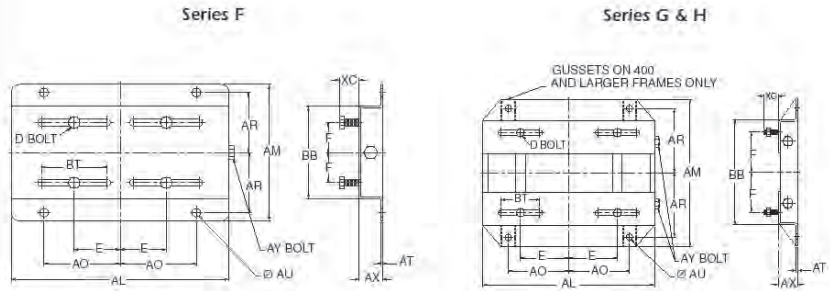

Dimensions = Inches

SERIES	FRAME	CAT. NO.	KIT NO.	AL	AM	AX	BB	E	F	AO	AR	AU	BT	AT	XC	D BOLT	AY BOLT	WT. LBS.	LIST PRICE
F	143	143A	KIT 143SB	10 1/2	7 1/2	1 1/8	5 1/2	2 3/4	2	3 3/4	3 3/8	3/8	3	0.119	13/16	5/16 x1	3/8x4	5	\$143
F	145	145A	KIT 145SB	10 1/2	8 1/2	1 1/8	6 1/2	2 3/4	2 1/2	3 3/4	3 7/8	3/8	3	0.119	13/16	5/16x1	3/8x4	6	
F	182	182A	KIT 182SB	12 3/4	9 1/2	1 1/2	6 1/2	3 3/4	2 1/4	4 1/2	4 1/4	1/2	3	0.134	1 1/2	3/8x1 3/4	1/2x6	9	
F	184	184A	KIT 184SB	12 3/4	10 1/2	1 1/2	7 1/2	3 3/4	2 3/4	4 1/2	4 3/4	1/2	3	0.134	1 1/2	3/8s 1 3/4	1/2x6	9	\$159
F	213	213A	KIT 213SB	15	11	1 3/4	7 1/2	4 1/4	2 3/4	5 1/4	4 3/4	1/2	3 1/2	0.164	1 1/2	3/8x1 3/4	1/2x6	13	\$191
F	215	215A	KIT 215SB	15	12 1/2	1 3/4	9	4 1/4	3 1/2	5 1/4	5 1/2	1/2	3 1/2	0.164	1 1/2	3/8x1 3/4	1/2x6	15	
G	254	254B2	KIT 254SB	17 3/4	15 1/8	2	10 3/4	5	4 1/8	6 1/4	6 5/8	5/8	4	3/16	1 7/16	1 1/2x1 3/4	5/8x6	17	\$308
G	256	256B2	KIT 256SB	17 3/4	16 7/8	2	12 1/2	5	5	6 1/4	7 1/2	5/8	4	3/16	1 7/16	1 1/2x1 3/4	5/8x6	18	
G	284	284B2	KIT 284SB	19 3/4	16 7/8	2	12 1/2	5 1/2	4 3/4	7	7 1/2	5/8	4 1/2	3/16	2 1/2	1 1/2x2	5/8x6	21	\$363
G	286	286B2	KIT 286SB	19 3/4	18 3/8	2	14	5 1/2	5 1/2	7	8 1/4	5/8	4 1/2	3/16	2 1/2	1 1/2x2	5/8x6	22	
G	324	324B2	KIT 324SB	22 3/4	19 1/4	2 1/2	14	6 1/4	5 1/4	8	8 1/2	3/4	5 1/4	3/16	2 3/16	5/8x2 1/2	3/4x9	31	\$601
G	326	326B2	KIT 326SB	22 3/4	20 3/4	2 1/2	15 1/2	6 1/4	6	8	9 1/4	3/4	5 1/4	3/16	2 3/16	5/8x2 1/2	3/4x9	32	
G	364	364B2	KIT 364SB	25 1/2	20 1/2	2 1/2	15 1/2	7	5 5/8	9	9 1/8	3/4	6	1/4	2 1/16	5/8x2 1/2	3/4x9	44	\$786
G	365	365B2	KIT 365SB	25 1/2	21 1/2	2 1/2	16 1/2	7	6 1/8	9	9 5/8	3/4	6	1/4	2 1/16	5/8x2 1/2	3/4 x9	45	
H	404	404B2	KIT 404SB	28 3/4	22 3/8	3	16 1/2	8	6 1/8	10	9 7/8	7/8	7	1/4	2 1/2	3/4x3	3/4x11	60	\$1,148
H	405	405B2	KIT 405SB	28 3/4	23 7/8	3	18	8	6 7/8	10	10 5/8	7/8	7	1/4	2 1/2	3/4x3	3/4x11	61	
H	444	444B2	KIT 444SB	31 1/4	24 5/8	3	19 1/4	9	7 1/4	11	11	7/8	7 1/2	1/4	2 1/2	3/4x3	3/4x11	67	\$1,587
H	445	445B2	KIT 445SB	31 1/4	26 5/8	3	21 1/4	9	8 1/4	11	12	7/8	7 1/2	1/4	2 1/2	3/4x3	3/4x11	69	
H	447	447B2	KIT 447SB	31 1/4	30 1/8	3	24 3/4	9	10	11	13 3/4	7/8	7 1/2	5/16	3	3/4x3 1/2	3/4x11	92	\$1,900
H	449	449B2	KIT 449SB	31 1/4	35 1/8	3	29 3/4	9	12 1/2	11	16 1/4	7/8	7 1/2	5/16	3	3/4x3 1/2	3/4x11	95	

THE MOST SUSTAINABLE MOTOR AVAILABLE TODAY



SYMAX® INDUSTRIAL – CAST IRON SEVERE DUTY
NEMA® 182-286T – IEC 132-180



SYMAX®-I WITH IPENTEK INTELLIDRIVE®

LOOKING FOR THE NEXT LEVEL OF EFFICIENCY?

SyMAX PMAC motors deliver impressive energy savings by the elimination of rotor conductor losses, optimized fan design, precision-wound stator and variable speed operation. These Ultra Efficient™ motors surpass European IE4 efficiency levels...5 years ahead of scheduled implementation, achieving efficiencies 25-35% over NEMA Premium®! The energy savings alone often pays for the motor in as little as two years. Additionally, the SyMAX motor efficiency profile remains flatter than an equivalent induction motor as the speed and load declines, allowing the user to capture even greater energy savings when operated at the application's ideal speed.

Electric motors consume an estimated 25% of all electricity and up to 65% of all electrical energy consumed by industrials. Energy costs are projected to continue to increase in the future. A "mere" 1% gain in energy efficiency would reduce carbon emissions by an estimated 80 million tons per year. SyMAX motors provide a very cost-effective way to reduce our "carbon footprint" and assure a cleaner environment.

SyMAX motors provide the highest level of reliability and longevity, coupled with low maintenance costs, due to their low operating temperature, high ingress protection levels and ultra-precision balancing techniques.

We've got the right motor for your application

REGAL® PERMANENT MAGNET VARIABLE SPEED SOLUTIONS

- √ High Efficiency
- √ Variable Speed
- √ High Duty Cycle
- √ Regulatory Requirements

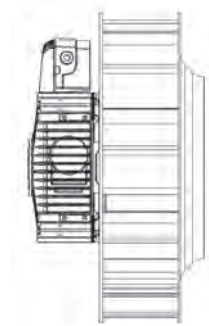

UlteMAX® Motor DISRUPTIVE FORM FACTOR

- √ Axial is best for the application
- √ For OEM's – Adapting for integration
- √ Wants reduced size and weight
- √ High power density and efficiency
- √ 3 – 15 HP



UlteMAX®

NovaMAX™ Motor TRADITIONAL CONSTRUCTION

- √ Radial NEMA® /IEC is best application
- √ For OEM's – With standard platforms
- √ Retrofit for Dist upgrade
- √ IE5+ efficiency
- √ Frames: 48, 56, 140, 180, 210, 250 & 280



NovaMAX™

For more information: (715) 675-3311

SPECIALS ARE OUR SPECIALTY

143-449T, IP56, Hazardous Duty® Motor

Class I and II,
Groups C, D, F & G



6805 DPFV

Cast Iron, Force Ventilated, F2



Roller Table Motor - Round

Annular fin design, Cast Iron,
FF Flange, F4



Roller Table Motor - Footed

Annular Fin Design, Cast Iron, F4

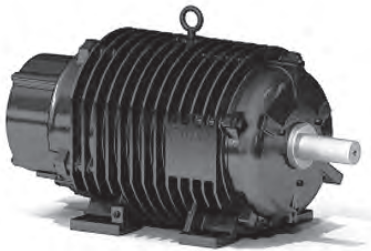

5007 - 5010 Frame

All New designs



TEFC Fire Pump

3Hp to 450HP,
Red Paint



Shaker Duty, Hazardous Duty Motor

210-360 Frame, Round,
Dual Flange



280 IEC TEBC

Blower Cooled, Ground
Brush, F3

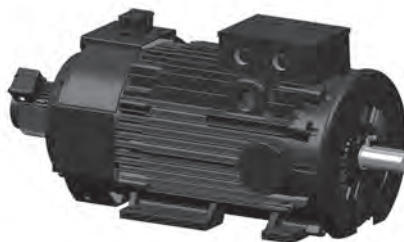

440TCZ TEFC

Cast Iron,
Tapered ODE Shaft, F2



SPECIALS ARE OUR SPECIALTY

320TCZ TEFC

Special Shaft, C-Face



Ground Brush

Opposite Drive End

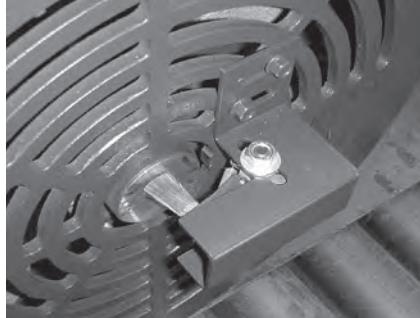

AEGIS® Shaft Grounding Ring

Drive End



320 TCZ TEBC

Blower Cooled, Special ODE Shaft, C-Face



320 TZ TENV

Non Ventilated, Special ODE Shaft, Encoder



5007-5013 Vertical Frames

TENV and TEFC



400TC TEBC

Blower Cooled, C-Face, F3



Marathon® "IntelliBrake"

Stearns® & Dings® Brakes with Imbedded Encoder



440TD TEFC Round

Cast Iron, Round, D-Flange



CAT. NO.	MODEL NO.	STOCK	PAGE NO.	CAT. NO.	MODEL NO.	STOCK	PAGE NO.	CAT. NO.	MODEL NO.	STOCK	PAGE NO.	CAT. NO.	MODEL NO.	STOCK	PAGE NO.
25U21T	KIT 250U	✓	254	3468	SEE X076		205	4722	5KH39QN5558T	✓	204,212	A129-(GE)	SEE AG129		245
28U25T	KIT 280U	✓	254	3583	SEE X000		182	4725	5KH32DN5587X	✓	136	A130-(GE)	SEE AG130		245
32U28T	KIT 320U	✓	254	3584	SEE X001		182	4730	5KH39QN9725T	✓	198	A157	KIT VRT87BRK	✓	244
36U32T	KIT 360U	✓	254	3585	SEE X002		182	4731	5KH39QN9696X	✓	198	A160	KIT 180TCD-WD	✓	239
40U36T	KIT 400U	✓	254	3586	SEE X003		182	4732	5KH39QN9702T	✓	198	A161	KIT 210TCD-WD	✓	239
44U40T	KIT 440U	✓	254	3587	SEE X004		182	4733	5KH39DNA533T	✓	198	A162	KIT 250TCD2-WD	✓	239
143A	KIT 143SB	✓	254	3588	SEE X005		182	4734	5KH32HNA532T	✓	198	A162A	B176066.00	✓	239
145A	KIT 145SB	✓	254	3589	SEE X009		182	4735	5KH33JNA534T	✓	198	A163	KIT 250TCD-WD	✓	239
182A	KIT 182SB	✓	254	3590	SEE X010		182	4738	5KH39QN9703T	✓	198	A163A	B176067.00	✓	239
184A	KIT 184SB	✓	254	3596	SEE X023		182	4739	5KH39QN9704T	✓	198	A164	KIT 280TCD2-WD	✓	239
213A	KIT 213SB	✓	254	3727	SEE X411		211	4757	5KH39QN9636T	✓	186	A164A	B176068.00	✓	239
215A	KIT 215SB	✓	254	3728	SEE X412		174	4758	5KH39QN9698T	✓	187	A165	KIT 280TCD-WD	✓	239
254B2	KIT 254SB	✓	254	3729	SEE X413		174	4759	5KH39QN9697T	✓	187	A165A	B176069.00	✓	239
256B2	KIT 256SB	✓	254	3730	SEE X414		174	4773	SEE 0005		200	A166	KIT 320TCD2-WD	✓	239
284B2	KIT 284SB	✓	254	3732	SEE X412		174	4774	5KH33GN5014U	✓	200	A166A	B176070.00	✓	239
286B2	KIT 286SB	✓	254	3733	SEE X415		174	4776	5KH39QN5539T	✓	186	A167	KIT 320TCD-WD	✓	239
324B2	KIT 324SB	✓	254	3736	SEE X456		174	4777	SEE 0701		200	A167A	B176071.00	✓	239
326B2	KIT 326SB	✓	254	3737	SEE X457		174	4778	5KH39QN9639T	✓	187	A168	KIT 360TCD2-WD	✓	239
364B2	KIT 364SB	✓	254	3738	SEE X458		174	4779	SEE 0100		200	A168A	B176072.00	✓	239
365B2	KIT 365SB	✓	254	3739	SEE X459		174	4781	5KC37HN3898U		200	A169	KIT 360TCD-WD	✓	239
404B2	KIT 404SB	✓	254	3746	SEE X452		174	4782	SEE 0600		200	A169A	B176073.00	✓	239
405B2	KIT 405SB	✓	254	3783	SEE X034		183	4784	SEE 0601		200	A170	KIT 180TFC-WD	✓	240
444B2	KIT 444SB	✓	254	3785	SEE X035		183	4785	SEE 0004		200	A171	KIT 210TFC-WD	✓	240
445B2	KIT 445SB	✓	254	3787	SEE X036		183	4786	SEE 0002		200	A172	KIT 250TFC2-WD	✓	240
447B2	KIT 447SB	✓	254	3945	SEE X445		177	4787	SEE 0003		200	A173	KIT 250TFC-WD	✓	241
449B2	KIT 449SB	✓	254	3946	SEE X446		177	4788	5KC37EN3900U	✓	200	A173A	B176026.00	✓	241
807L	Century	✓	188	4050	SEE 4370		186	4798	5KH35FN153T	✓	186	A174	KIT 280TFC2-WD	✓	241
815A	Century	✓	188	4304	5KH39QN5543	✓	185	4805	5KH32GNB811X	✓	136	A175	KIT 280TFC-WD	✓	241
815V2	Century	✓	188	4305	5KH39QN5511X	✓	185	9029	SEE S013A		27	A175A	B176028.00	✓	241
889A	Century	✓	189	4306	5KH39QN5537X	✓	186	9030	5KC49NN0222X		223	A176	KIT 320TFC2-WD	✓	241
889V2	Century	✓	189	4308	SEE HG700		186	9031	5KC49MN2043Y	✓	216	A177	KIT 320TFC-WD	✓	241
902L	Century	✓	189	4309	5KH39QN9514X	✓	186	9032	5KC49MN2049Y	✓	216,223	A177A	B176030.00	✓	241
904L	Century	✓	194	4310	5KH39QN5508X		186	9033	5KC49NN2050Y	✓	216	A178	KIT 360TFC2-WD	✓	241
906L	Century	✓	194	4311	5KH39QN5529X	✓	186	9034	SEE 9034A		27	A179	KIT 360TFC-WD	✓	241
914L	Century	✓	214	4314	SEE D107		185	9034A	---		27	A179A	B176032.00	✓	241
915L	Century	✓	214	4319	5KH39QN9429T	✓	186	9035	5KCR48TN2650Y	✓	216	A181	KIT 143TCTN-841	✓	242
917L	Century	✓	188	4322	5KH39QN9548	✓	185	9036	5KCR48UN2653Y	✓	216	A182	KIT 180TFC-841	✓	242
919L	Century	✓	188	4338	5KH39QN9541T	✓	187	9038B	5KCR49ZN2722Y	✓	216	A182A	---	✓	242
920L	Century	✓	188	4349	5KH39QN9537X	✓	24	9040	5KCR48UN2654Y	✓	216	A183	KIT 210TFCFS-841	✓	242
921L	Century	✓	188	4350	5KH39QN5538X	✓	185	A000	KIT 391-200-01	✓	250	A183A	---	✓	242
922L	Century	✓	188	4351	5KH39QN9542	✓	27	A001	KIT 391-200-02	✓	250	A184	KIT 250TFCNA-841	✓	242
924L	Century	✓	188	4352	SEE S102		185	A082	B176222.00	✓	248	A185	KIT 280TFCN-841	✓	242
925L	Century	✓	188	4354	5KH39QN9538	✓	24	A083	KIT 250DCD-WD	✓	248	A186	KIT 280TFCNA-841	✓	242
925AL	Century	✓	188	4355	5KH39QN9525	✓	185	A084	B176224.00	✓	248	A187	KIT 320TFCFS-841	✓	242
927L	Century	✓	188	4359	5KH39QN5523	✓	185	A085	B176225.00	✓	248	A188	KIT 360TFCFSR-841	✓	242
927AL	Century	✓	188	4360	5KH39QN9548	✓	186	A086	B176226.00	✓	248	A189	KIT 360TSCFSR-841	✓	242
1814T	KIT 180U	✓	254	4362	5KH39QN9686X	✓	24	A087	B176227.00	✓	248	A190	KIT 400TFCFS-841	✓	242
2118T	KIT 210U	✓	254	4363	5KH39QN5526X	✓	186	A088	B176228.00	✓	248	A191	KIT 400TSCFS-841	✓	242
3001	SEE X230		203,209	4364	5KH39QN5541X	✓	185	A091	B176241.00	✓	248	A192	KIT 440TFCFS-841	✓	242
3028	SEE X081		172	4368	5KH39QN9397	✓	27	A092	B176214.00	✓	248	A193	KIT 440TSCFS-841	✓	242
3037	SEE X090		172	4369	5KH39QN5508	✓	186	A093	B176215.00	✓	248	A194	KIT 440TFCN-841	✓	242
3048	SEE X085		172	4370	5KH39QN9682	✓	186	A094	KIT 280DCF-WD	✓	248	A195	KIT 440TSCFN-841	✓	242
3050	SEE X209		182,211	4371	5KH39QN5529	✓	186	A095	B176217.00	✓	248	A195-(GE)	SEE AG195A		245
3070	SEE X200		212	4372	5KH39QN9546	✓	27	A096	B176218.00	✓	248	A197	KIT 197	✓	248
3082	SEE X236		182,207, 211	4373	5KH39QN9543	✓	27	A097	B176219.00	✓	248	A198	KIT 198	✓	248
				4376	5KH39QN9547	✓	27	A098	B176220.00	✓	248	A199	KIT 199	✓	248
3084	SEE X441		173	4377	5KH39QN9524	✓	186	A099	B176221.00	✓	248	A201	KIT 201	✓	248
3085	SEE X442		173	4381	5KH39QN5528X	✓	186	A100	KIT 100	✓	246	A202	KIT 202	✓	248
3086	SEE X443		173	4383	5KH39QN9513X	✓	186	A103	KIT 103	✓	253	A204	KIT 210TFCFL	✓	240
3132	SEE X203		207	4386	SEE S120		195	A104	KIT 104	✓	245	A206	KIT 210TFCFS	✓	240
3155	SEE X278		173,211	4387	5KH39QN9684	✓	187	A105	KIT 105	✓	247	A209	KIT 250TFCFL	✓	241
3204	SEE X450		174	4389	5KH39QN9548X	✓	185	A106	KIT 106	✓	247	A210A	KIT 280TCDR	✓	239
3205	SEE X451		174	4390	5KH39QNA039	✓	187	A107	KIT 107-637	✓	245	A212-(GE)	SEE AG212		239
3206	SEE X302		204	4392	5KH39QN9405X	✓	187	A109	KIT 109	✓	253	A213	KIT 320TCDR	✓	239
3208	SEE X303		204	4393	5KH39QN9544X	✓	187	A109-(GE)	SEE AG109		245	A214	KIT 320TFCFS	✓	241
3212	SEE X304		204	4396	5KH39QN9683	✓	186	A110	KIT 110	✓	245	A215-(GE)	SEE AG215		240
3220	SEE X216		173,211	4399	5KH39QN9551X	✓	185	A110-(GE)	SEE AG110		245	A216	KIT 360TCDSD	✓	239
3221	SEE X297		173,211	4404	5KH39QN5550X	✓	204,212	A111	KIT 111	✓	246	A217	KIT 360TFCFS	✓	241
3230	SEE X416		174	4406	5KH32FN5586X	✓	136	A111-(GE)	SEE AG111		245	A219	KIT 360TSCDS	✓	239
3280	SEE X033		183	4412	5KH39QN9550X	✓	185	A112	KIT 112	✓	245	A222	KIT 400TCDSD	✓	240
3288	SEE X405		207	4422	5KH39QN9687	✓	187	A112-(GE)	SEE AG112		245	A223	KIT 400TFCFS	✓	241
3290	SEE X039		183	4602	5KH39QN9518X	✓	187	A113	KIT 113	✓	245	A224-(GE)	SEE AG105		247
3328	SEE X213		172	4680	5KH32FN3120T	✓	185	A113-(GE)	SEE AG113		245	A225	KIT 400TCDSD	✓	239
3329	SEE X214		172	4682	5KH35JN3132T	✓	186	A114	KIT 114	✓	245	A225-(GE)	SEE AG106		247
3330	SEE X221		172	4684	5KH36MN3127T	✓	187	A114-(GE)	SEE AG114		245	A226	KIT 400TSCFS	✓	241
3331	SEE X298		172	4686	5KC46LN0269X	✓	191	A115-(GE)	SEE AG115		245	A228	KIT 440TCDSD	✓	240
3463	SEE X077		206	4688	5KC49NN0061T	✓	191	A116	KIT 116	✓	253	A228-(GE)	SEE AG228		247
3464	SEE X073		206	4701	5KH39QN5512T	✓	185	A119	KIT 364-445CB	✓	249	A229	KIT 440TFCFS	✓	241
3465	SEE X072		205	4702	5KH33HN5725X	✓	185	A125-(GE)	SEE AG125		245	A229-(GE)	SEE AG229		247
3466	SEE X074		206	4707	SEE 4757		186	A127-(GE)	SEE AG127		245	A231	KIT 440TSCDS	✓	240
3467	SEE X075		206	4708	SEE D162		187	A128-(GE)	SEE AG128		245	A232	KIT 440TSCFS	✓	241

INDEX

Index

Catalog Number/Model Number

INDEX

CAT. NO.	MODEL NO.	STOCK	PAGE NO.	CAT. NO.	MODEL NO.	STOCK	PAGE NO.	CAT. NO.	MODEL NO.	STOCK	PAGE NO.	CAT. NO.	MODEL NO.	STOCK	PAGE NO.
A234	KIT 234	✓	248	A435	KIT 56CDR-1	✓	239	A572	KIT 905165	✓	243	A670	B176201.00	✓	242
A239	KIT 250TCFPA	✓	241	A436	KIT 140TCDR-1	✓	239	A573	KIT 1005215	✓	243	A671	B176202.00	✓	242
A240	KIT 240	✓	245	A437	KIT 56CFR-1	✓	240	A574	KIT 1125215	✓	243	A672	B176203.00	✓	242
A241	KIT 241	✓	245	A438	KIT 140TCFR-1	✓	240	A575	KIT 1325265	✓	243	A673	B176204.00	✓	242
A242	KIT 242	✓	245	A445	KIT 440-7.5	✓	246	A576	KIT 1605300	✓	243	A675	B176205.00	✓	242
A243	KIT 243	✓	246	A446	KIT 440-10	✓	246	A577	KIT 1805300	✓	243	A676	B176206.00	✓	242
A244	KIT 244	✓	246	A447	KIT 440-12.5	✓	246	A578	KIT 2005350	✓	243	A677	B176194.00	✓	242
A245	KIT 245	✓	246	A448	KIT 440-15	✓	246	A579	KIT 2255400	✓	243	A678	B176207.00	✓	242
A247	KIT 247	✓	248	A449	KIT 440-17.5	✓	246	A580	KIT 175995	✓	243	A680	4900030	✓	251
A248	KIT 248	✓	248	A459-(GE)	SEE A104	✓	245	A581	KIT 175985	✓	243	A681A	4900670	✓	251
A249	KIT 249	✓	246	A478-(GE)	SEE A111	✓	246	A581A	KIT 175817	✓	243	A686	KIT EPC260 2048	✓	252
A250	KIT 250	✓	246	A487-(GE)	SEE A243	✓	246	A582	KIT 175987	✓	243	A687	KIT HS201024-NV	✓	252
A251	KIT 251	✓	246	A488-(GE)	SEE A244	✓	246	A582A	KIT 175818	✓	243	A688-10	KIT A688-10	✓	252
A252	KIT 252	✓	246	A489-(GE)	SEE A245	✓	246	A582B	KIT 175832	✓	243	A688-20	KIT A688-20	✓	252
A253	KIT 253	✓	246	A493-(GE)	SEE A114	✓	245	A583	KIT 175989	✓	243	A688-25	KIT A688-25	✓	252
A254	KIT 254	✓	246	A494-(GE)	SEE A110	✓	245	A583A	KIT 175819	✓	243	A688-30	KIT A688-30	✓	252
A256	KIT 256	✓	247	A496	KIT EP2400	✓	253	A584	KIT 175991	✓	243	A688-50	KIT A688-50	✓	252
A257	KIT 257	✓	247	A495-1	KIT SGR-0.625-1A4-UK	✓	253	A585	KIT 175900	✓	243	A688-60	KIT A688-60	✓	252
A258	KIT 258	✓	247	A495-2	KIT SGR-0.875-1A4-UK	✓	253	A586	KIT 175901	✓	243	A688-100	KIT A688-100	✓	252
A259	KIT 259	✓	246	A495-3	KIT SGR-1.125-1A4-UK	✓	253	A587	KIT 175902	✓	243	A690-15	KIT A690-15	✓	252
A261	KIT 261	✓	249	A495-4	KIT SGR-1.375-1A4-UK	✓	253	A588	KIT 175903	✓	243	A691	KIT 25TEBCNA	✓	251
A262	KIT 145CTCN-841	✓	242	A495-5	KIT SGR-1.625-1A4-UK	✓	253	A589	KIT 175833	✓	243	A692	KIT 21TEBC	✓	251
A277	KIT 277	✓	246	A495-6	KIT SGR-1.875-1A4-UK	✓	253	A590	KIT 175834	✓	243	A695	KIT 32TEBC	✓	251
A278	KIT 278	✓	246	A495-7	KIT SGR-2.125-1A4-UK	✓	253	A593	KIT 175837	✓	243	A696	KIT 36TEBC	✓	251
A279	KIT 279	✓	245	A495-8	KIT SGR-2.375-1A4-UK	✓	253	A594	KIT 175619	✓	243	A697	KIT 40TEBC	✓	251
A280	KIT 280	✓	245	A495-9	KIT SGR-2.875-1A4-UK	✓	253	A596	KIT 175835	✓	243	A698	KIT 44TEBC-313	✓	251
A281	KIT 281	✓	245	A495-10	KIT SGR-3.375-1A4-UK	✓	253	A598	KIT 175836	✓	243	A699	KIT 44TEBC-316	✓	251
A282	KIT 282	✓	245	A495-14	KIT SGR-4.875-1A4-UK	✓	253	A600	KIT 175181	✓	239	A700	KIT 44TEBC-318	✓	251
A283	KIT 283	✓	245	A499-1	KIT SGR-0.625-UK	✓	253	A601	KIT 250TCFP	✓	241	A701	KIT 28TEBCNA	✓	251
A284	KIT 250TCFNA	✓	241	A499-2	KIT SGR-0.875-UK	✓	253	A602	KIT 175066	✓	239	A711	KIT HSD351024-NV	✓	252
A287	KIT 280TCDC	✓	239	A499-3	KIT SGR-1.125-UK	✓	253	A603	KIT 143TCFN	✓	240	A712	KIT HSD351024-FC	✓	252
A293	KIT 440TSCDN	✓	240	A499-4	KIT SGR-1.375-UK	✓	253	A606	KIT 210TCDW	✓	239	A713	KIT AV56512-NV	✓	252
A297	KIT 3BRK3A	✓	244	A499-5	KIT SGR-1.625-UK	✓	253	A609	KIT 210TCFW	✓	240	A715	KIT 140CB	✓	250
A298	KIT 6BRK3A	✓	244	A499-6	KIT SGR-1.875-UK	✓	253	A610	KIT 280TCDP	✓	239	A718	KIT 180R	✓	250
A299	KIT 10BRKA	✓	244	A499-7	KIT SGR-2.125-UK	✓	253	A611	KIT 280TCFP	✓	241	A720	KIT 180/210CB	✓	249
A301	KIT 3BRK3	✓	244	A499-8	KIT SGR-2.375-UK	✓	253	A612	KIT 250TCDX	✓	239	A721	KIT 210R	✓	250
A302	KIT 6BRK3	✓	244	A499-9	KIT SGR-2.875-UK	✓	253	A613	KIT 320TCDP	✓	239	A722	KIT 250CB	✓	249
A303	KIT 10BRK	✓	244	A499-10	KIT SGR-3.375-UK	✓	253	A614	KIT 320TCFP	✓	241	A723	KIT 250RPPA	✓	250
A306	KIT 3BRK1	✓	244	A500-5	KIT SGR-11.2	✓	253	A615	KIT 280TCFN	✓	241	A724	KIT 250RFNA	✓	250
A307	KIT 6BRK1	✓	244	A500-8	KIT SGR-14.4	✓	253	A617	KIT 280TCFPA	✓	241	A725	KIT 250R	✓	250
A308	KIT 308	✓	245	A500-14	KIT SGR-20.7	✓	253	A618	KIT 280TCFNA	✓	241	A726	KIT 280RPPA	✓	250
A311	KIT 311	✓	248	A500-20	KIT SGR-27.1	✓	253	A619	KIT 320TCFPA	✓	241	A727	KIT 280RFFN	✓	250
A312	KIT BM6BRK	✓	244	A500-26	KIT SGR-33.4	✓	253	A620	KIT 440TCFN	✓	241	A728	KIT 280R	✓	250
A313	KIT BM10BRK	✓	244	A500-32	KIT SGR-39.8	✓	253	A621	KIT 440TSCFN	✓	241	A729	KIT 280CB	✓	249
A315	KIT BM6BRK575	✓	244	A500-35	KIT SGR-43.0	✓	253	A622	KIT 175067	✓	239	A730	KIT 320CB	✓	249
A316	KIT BM10BRK575	✓	244	A500-38	KIT SGR-46.1	✓	253	A623	KIT 449TCFS	✓	241	A731	KIT 280RFNA	✓	250
A317	KIT BM6BRK115	✓	244	A500-44	KIT SGR-52.5	✓	253	A624	KIT 449TSCFS-1	✓	241	A733	KIT 320RPPA	✓	250
A318	KIT BM10BRK115	✓	244	A500-50	KIT SGR-58.8	✓	253	A625	KIT 449TSCFS-2	✓	241	A736	KIT HS35A1024-NV	✓	252
A371	KIT 370-3	✓	246	A500-62	KIT SGR-71.5	✓	253	A626	KIT 175058	✓	239	A737	KIT HS35A1024-FC	✓	252
A372	KIT 370-4	✓	246	A500-74	KIT SGR-84.2	✓	253	A627	KIT 175059	✓	239	A738	KIT HS35A1024-BC	✓	252
A373	KIT 370-5	✓	246	A518	161L110AAG4	✓	245	A628	KIT 175060	✓	239	A739	KIT HS35A2048-NV	✓	252
A375	KIT 370-7.5	✓	246	A534	161L187BAG1	✓	239	A629	KIT 175601	✓	239	A740	KIT HS35A2048-FC	✓	252
A376	KIT 370-10	✓	246	A535	161L187BAG1	✓	239	A630	KIT 180TDFR	✓	242	A742	KIT HS35M1024	✓	252
A378	KIT 370-15	✓	246	A536	161L188BAG1	✓	240	A631	KIT 280TDFP	✓	242	A744	KIT HS35M2048	✓	252
A379	KIT 370-17.5	✓	246	A537	161L188BAG1	✓	240	A632	KIT 320TDFP	✓	242	A746	KIT HS25A1024-NV	✓	252
A380	KIT 370-20	✓	246	A549	52A101229AAG1	✓	248	A634	KIT 400TDFS	✓	242	A747	KIT HS25A2048-NV	✓	252
A381	KIT 370-25	✓	246	A550	KIT 175828	✓	243	A637	KIT 360TDFC	✓	242	A748	KIT M561024BRK-140	✓	252
A382	KIT 370-30	✓	246	A551	KIT 175829	✓	243	A640	KIT 180TCN4.5	✓	240	A748A	KIT AV561024BRK-140	✓	252
A395	KIT 360TCFSR	✓	241	A552	KIT 175830	✓	243	A641	KIT 180TCN8.5	✓	240	A749	KIT M561024BRK-182	✓	252
A396	KIT 360TSCFSR	✓	241	A553	KIT 175831	✓	243	A642	KIT 175077	✓	240	A749A	KIT AV561024BRK-182	✓	252
A414	KIT 400TC2-WD	✓	239	A554	KIT 175984	✓	243	A643	KIT 175296	✓	240	A750	KIT M851024BRK-184	✓	252
A414A	B176074.00	✓	239	A554A	KIT 1759810	✓	243	A644	KIT 180CF8.5-1	✓	240	A750A	KIT AV851024BRK-184	✓	252
A415	KIT 400TC2-WD	✓	240	A555	KIT 175986	✓	243	A645	KIT 180CF4.5-1	✓	240	A751	KIT M851024BRK-210	✓	252
A415A	B176075.00	✓	240	A555A	KIT 1759811	✓	243	A646	KIT 210TCN	✓	240	A751A	KIT AV851024BRK-210	✓	252
A416	KIT 444/5TC2-WD	✓	240	A555B	KIT 175827	✓	243	A647	KIT 250TDFPA	✓	242	A752	KIT M851024BRK-250	✓	252
A416A	B176076.00	✓	240	A556	KIT 175988	✓	243	A648	KIT 250TDFNA	✓	242	A752A	KIT AV851024BRK-250	✓	252
A417	KIT 444/5TC2-WD	✓	240	A556A	KIT 175812	✓	243	A649	KIT 649R	✓	242	A753	KIT M31024-NV	✓	252
A417A	B176077.00	✓	240	A557	KIT 175990	✓	243	A650	KIT 650R	✓	242	A753A	KIT HS451024-NV	✓	252
A419	KIT 447/9TCD-WD	✓	240	A558	KIT 175890	✓	243	A651	KIT 651R	✓	242	A754	KIT M31024-FC	✓	252
A420	B176240.00	✓	240	A559	KIT 175994	✓	243	A652	KIT 175068	✓	240	A754A	KIT HS451024-FC	✓	252
A421	KIT 210TCFCD-WD	✓	240	A561	KIT 631475	✓	243	A653	KIT 175191	✓	241	A755	KIT 360BRFSR-314	✓	251
A424	KIT 400TCF2-WD	✓	241	A562	KIT 711485	✓	243	A654	KIT 175061	✓	241	A756	KIT 400BRFS-316	✓	251
A424A	B176034.00	✓	241	A563	KIT 8014110	✓	243	A655	KIT 145TCFN	✓	240	A757	KIT 440BRFS-318	✓	251
A425	KIT 400TCF-WD	✓	241	A564	KIT 9014115	✓	243	A656	KIT 280TDFNA	✓	242	A758	KIT 449BRFS	✓	251
A425A	B176035.00	✓	241	A565	KIT 10014130	✓	243	A657	KIT 320TDFPA	✓	242	A759	KIT 440BRFN	✓	251
A426	KIT 444/5TCF2-WD	✓	241	A566	KIT 11214130	✓	243	A658	KIT 320TDFS	✓	242	A760	KIT 440BRFN	✓	251
A426A	B176036.00	✓	241	A567	KIT 13214165	✓	243	A662	KIT 175614	✓	248	A761	KIT 449BRFS	✓	251
A427	KIT 444/5TCF-WD	✓	241	A568	KIT 16014215	✓	243	A666	KIT 175691	✓	240	A763	KIT LKSR02	✓	252
A427A	B176037.00	✓	241	A569	KIT 635115	✓	243	A667	KIT 175844	✓	240	A764	KIT LKSR03	✓	252
A428	KIT 447/9TCF2-WD	✓	241	A570	KIT 715130	✓	243	A668	KIT A02H1024-BC LED	✓	252	A772	KIT HS351024-NV	✓	252
A429	KIT 447/9TCF-WD	✓	241	A571	KIT 805165	✓	243	A669	KIT A02H2048-BC LED	✓	252	A774	KIT HS351024-FC	✓	252

CAT. NO.	MODEL NO.	STOCK	PAGE NO.	CAT. NO.	MODEL NO.	STOCK	PAGE NO.	CAT. NO.	MODEL NO.	STOCK	PAGE NO.	CAT. NO.	MODEL NO.	STOCK	PAGE NO.
A775	KIT HS351024-BC	✓	252	A978	---	✓	249	B206	048S17D2107	✓	185	B597	Century	✓	119
A776	KIT HS352048-NV	✓	252	A979	---	✓	249	B207	048S17D2108	✓	186	B598	Century	✓	119
A777	KIT HS352048-FC	✓	252	A980	B176196.00	✓	249	B208	048S17D2109	✓	187	B599	Century	✓	119
A778	KIT HS352048-BC	✓	252	A981	B176197.00	✓	249	B210	056C17D2100	✓	190	B600	SEE H176	✓	187
A779	KIT HS35B1024-NV	✓	252	A982	B176198.00	✓	249	B220	Century	✓	170	B604	SEE H169	✓	185
A779A	KIT HS35A/B1024-NV	✓	252	A983	B176199.00	✓	249	B222	Century	✓	170	B605	SEE H170	✓	185
A780	KIT HS35B2048-NV	✓	252	A984	B176200.00	✓	249	B300	048S17D2052	✓	185	B606	048S17D2116	✓	186
A780A	KIT HS35A/B2048-NV	✓	252	A1000	KIT 180-210 TERM BLK	✓	243	B302	048S17D2054	✓	185	B607	048S17D2117	✓	186
A781	KIT HS35B1024-BC	✓	252	A1001	KIT 250-320 TERM BLK	✓	243	B303	048S17D2055	✓	185	B608	056C17D2113	✓	190
A782	KIT HS35B2048-BC	✓	252	A1002	KIT 360 TERM BLK	✓	243	B304	048S17D2056	✓	186	B609	056B17D2013	✓	191
A783	KIT HS35B1024-FC	✓	252	A1003	KIT 400-445 TERM BLK	✓	243	B305	048S17D2057	✓	186	B652ES	Century	✓	29
A783A	KIT HS35A/B1024-FC	✓	252	A1004	KIT 447/9 TERM BLK	✓	243	B306	048S17D2058	✓	187	B664	Century	✓	31
A784	KIT HS35B2048-FC	✓	252	A1010	KIT AV321024-NV	✓	252	B307	048S17D2059	✓	187	B666	Century	✓	170
A784A	KIT HS35A/B2048-FC	✓	252	A1011	KIT AV322048-NV	✓	252	B308	SEE H208	✓	199	B671ES	Century	✓	26
A785	KIT LKSR512	✓	252	A1012	KIT AV32B1024-NV	✓	252	B309	SEE H212	✓	199	B672ES	Century	✓	29
A786	KIT LKSR-CFACE	✓	252	A1013	KIT AV32B2048-NV	✓	252	B310	SEE C235	✓	191	B685	Century	✓	216
A787	KIT 4498BFS-322	✓	251	A1014	KIT AV321024-FC	✓	252	B311	056C17D5322	✓	191	B695	Century	✓	31
A788	KIT 4498BFS-319	✓	251	A1015	KIT AV322048-FC	✓	252	B312	048C17D2041	✓	190	B696	Century	✓	31
A789	KIT SL561024-182NV	✓	252	A1016	KIT AV32B1024-FC	✓	252	B313	048C17D2042	✓	190	B697	Century	✓	31
A789A	KIT ST561024-182NV	✓	252	A1017	KIT AV32B2048-FC	✓	252	B314	048C17D2043	✓	190	B699	Century	✓	35
A790	KIT SL851024-184NV	✓	252	A1209	KIT 250TCFL-R	✓	241	B315	048C17D2044	✓	190	B701	Century	✓	193
A790A	KIT ST851024-184NV	✓	252	A1287	KIT 280TCDDA	✓	239	B316	SEE B1316	✓	190	B702ES	Century	✓	26
A791	KIT SL851024-210NV	✓	252	AG109	161L113AAG1	✓	245	B317	056C17D2072	✓	190	B703	048N17D14	✓	186
A791A	KIT ST851024-210NV	✓	252	AG110	161L113AAG2	✓	245	B318	056C17D2073	✓	191	B703	Century	✓	193
A792	KIT SL851024-250NV	✓	252	AG111	161L113AAG3	✓	245	B319	056C17D2074	✓	191	B722L	Century	✓	193
A792A	KIT ST851024-250NV	✓	252	AG112	161L113AAG4	✓	245	B320	SEE H217	✓	199	B734ES	Century	✓	26
A793	KIT M561024-NV	✓	252	AG113	161L113AAG5	✓	245	B321	SEE H290	✓	199	B735ES	Century	✓	26
A793A	KIT AV561024-NV	✓	252	AG114	161L113AAG6	✓	245	B322	048S17D2053	✓	185	B753ES	Century	✓	29
A794	KIT M561024-BC	✓	252	AG115	161L113AAG9	✓	245	B330	SEE C1160	✓	191	B793	Century	✓	33
A794A	KIT AV561024-BC	✓	252	AG125	161L113ADG1	✓	245	B331	SEE C420	✓	191	B794	Century	✓	33
A795	KIT L4498BFS-322	✓	251	AG127	161L113ADG3	✓	245	B332	056B17D5701	✓	191	B813	Century	✓	216
A796	KIT L449TEBC	✓	251	AG128	161L113ADG4	✓	245	B334	SEE C475	✓	191	B860ES	Century	✓	29
A800	KIT 56 EXPR BOX	✓	249	AG129	161L113ADG5	✓	245	B335	056B17D5703	✓	191	B861	Century	✓	35,224
A801	KIT ENCBOX	✓	252	AG130	161L113ADG14	✓	245	B336	056C17D5347	✓	191	B869	Century	✓	223
A803	KIT LDRDCR-M	✓	249	AG195	SEE AG195A	✓	245	B337	056C17D5348	✓	191	B1316	5KC49GN001	✓	190
A807	KIT STUBSHAFT 1IN	✓	253	AG195A	161L110AAG1	✓	245	B338	056C17D5349	✓	191	B1502	5KH39QN105	✓	195
A903	KIT 903	✓	244	AG212	161L185AAG1	✓	239	B348	SEE 4392	✓	187	B1504	5KH35MMN56	✓	195
A904	KIT 904	✓	244	AG215	161L186AAG1	✓	240	B350	SEE C486	✓	191	B1507	5KH42GM0336	✓	195
A905	KIT 905	✓	244	AG228	112A515AKG4	✓	247	B352	056B17D5331	✓	191	BF1052V1	Century	✓	192
A906	KIT 906	✓	244	AG229	112A515ASG2	✓	247	B353	056B17D67	✓	190	BF1072	Century	✓	192
A907	KIT 907	✓	244	AG234	161L528AAG1	✓	248	B380	SEE H209	✓	199	BF1102	Century	✓	193
A908	KIT 908	✓	244	AG697	161L210AAP1	✓	250	B381-(ME)	SEE H214	✓	199	BF2006L	Century	✓	188
A909	KIT 909	✓	244	AR2024	Century	✓	198	B381	Century	✓	217	BF2008	Century	✓	188
A910	KIT 910	✓	244	AR2034	Century	✓	198	B383-(ME)	SEE H171	✓	185	BF20086V1	Century	✓	188
A911	KIT 911	✓	244	AR2054	Century	✓	198	B383	Century	✓	217	BF2024	Century	✓	188
A933	B176242.00	✓	249	ARB2014L	Century	✓	194	B384-(ME)	SEE H172	✓	185	BF2034	Century	✓	188
A935	B176209.00	✓	249	ARB2014L2	Century	✓	194	B384	Century	✓	216	BF2034B	Century	✓	188
A936	B176210.00	✓	249	ARB2016M	Century	✓	194	B385	Century	✓	217	BF2054	Century	✓	189
A937	B176211.00	✓	249	ARB2016SLV1	Century	✓	194	B386	Century	✓	216	BF2054V1	Century	✓	189
A938	B176212.00	✓	249	ARB2016SV1	Century	✓	194	B387-(ME)	SEE H173	✓	186	BF2056D	Century	✓	189
A939	B176213.00	✓	249	ARB2024L1	Century	✓	194	B387	Century	✓	216	BGF2014L	Century	✓	188
A940	52D310833AAP001	✓	250	ARB2024L2	Century	✓	194	B388	SEE H174	✓	186	BK1052	Century	✓	192
A941	52D311808ARP1	✓	250	ARB2024L3	Century	✓	194	B389	SEE H175	✓	187	BK1054	Century	✓	192
A942	52D310814AAP1	✓	250	ARB2024L4	Century	✓	194	B400	048S17D997	✓	171	BK1072	Century	✓	192
A945	115D964P1	✓	250	ARB2024ML	Century	✓	194	B401	056S17D2062	✓	171	BK1102	Century	✓	193
A946	115D964P2	✓	250	ARB2026SLV1	Century	✓	194	B402	048S17D7209	✓	171	BK3054V1	Century	✓	197
A947	115D963P1	✓	250	ARB2026SV1	Century	✓	194	B412	Century	✓	31	BK3074	Century	✓	197
A948	113A617AG001	✓	250	ARB2034L1	Century	✓	194	B416ES	Century	✓	29	BK3102	Century	✓	197
A949	113A620AYP1	✓	250	ARB2034L2	Century	✓	194	B417	Century	✓	35	BK3202L	Century	✓	197
A950	976B399AAP9	✓	250	ARB2034L3	Century	✓	194	B418	Century	✓	35	BR3202LES	Century	✓	44
A951	976B399AAP12	✓	250	ARB2034L4	Century	✓	194	B420	Century	✓	35	C031	Century	✓	214
A952	976B399AAP13	✓	250	ARB2034L5	Century	✓	194	B500	SEE H236	✓	195	C032A	Century	✓	214
A953	976B399ABP6	✓	250	ARB2034L6	Century	✓	194	B501	SEE H234	✓	195	C033	Century	✓	214
A954	976B399ABP9	✓	250	ARB2036S	Century	✓	194	B502	SEE B1502	✓	195	C034	Century	✓	214
A955	976B399ABP10	✓	250	ARB2036SL	Century	✓	194	B504	SEE B1504	✓	195	C035	Century	✓	214
A956	161L198AAG9	✓	250	ARB2054L1	Century	✓	194	B506	056S17F5303	✓	195	C036	Century	✓	214
A957	161L198AAG10	✓	250	ARB2054L2	Century	✓	194	B507	SEE B1507	✓	195	C048	Century	✓	116
A958	161L197ABG1	✓	250	ARB2054L3	Century	✓	194	B513ES	Century	✓	29	C060	Century	✓	194
A959	161L197ABG11	✓	250	ARB2054L4	Century	✓	194	B519	Century	✓	33	C061	Century	✓	35
A960B	10003237-001-049	✓	250	ARS2020L	Century	✓	194	B582	Century	✓	119	C062	Century	✓	35
A961A	003062.36	✓	250	ARS2050DV1	Century	✓	194	B583	Century	✓	119	C081	Century	✓	176
A962	52D310822ACP1	✓	250	B100	056S17D2064	✓	187	B584	Century	✓	119	C102A	145TTDR14007	✓	46
A963	52D311819ABP1	✓	250	B171	Century	✓	192	B585	Century	✓	119	C102LES	Century	✓	26
A964	52A103486G1	✓	250	B172ES	Century	✓	26	B586	Century	✓	119	C102B	145TTDR16403	✓	46
A965	111A271P113	✓	246	B177LES	Century	✓	26	B587	Century	✓	119	C103	SEE C103A	✓	46
A972	B176237.00	✓	249	B182	Century	✓	223	B588	Century	✓	192	C103A	145TTDR16319	✓	46
A973	B176238.00	✓	249	B183	Century	✓	35	B589	Century	✓	193	C104B	SEE C104C	✓	46
A974	B176239.00	✓	249	B193	056T34D5357	✓	196	B590	Century	✓	192	C104C	182TTDW16019	✓	46
A975	---	✓	249	B200	056S17D2049	✓	187	B592	Century	✓	119	C105B	SEE C105C	✓	46
A976	B176243.00	✓	249	B201	056S17D2047	✓	185	B595	Century	✓	119	C105C	184TTDW16304	✓	46
A977	---	✓	249	B202	056S17D2048	✓	186	B596	Century	✓	119	C105L	Century	✓	192

Index

Catalog Number/Model Number

INDEX

CAT. NO.	MODEL NO.	STOCK	PAGE NO.	CAT. NO.	MODEL NO.	STOCK	PAGE NO.	CAT. NO.	MODEL NO.	STOCK	PAGE NO.	CAT. NO.	MODEL NO.	STOCK	PAGE NO.
C105-(GE)	SEE CG105		27	C186A	056B17DRR70022A1	✓	25	C237B	215TTFWD16012	✓	59	C322	Century	✓	31
C106A	SEE C106B		46	C187	SEE C187A		25	C238B	SEE C238C		59	C322-(ME)	SEE C322B		85
C106B	213TTDWD16024	✓	46	C187A	056B34D11011	✓	25	C238C	184TTFW16013	✓	59	C322A	SEE C322B		85
C109LES	Century	✓	26	C188	SEE C188A		24	C239-(GE)	SEE CG239		191	C322B	145TTGN16034	✓	85
C111	SEE K1301		46	C188A	143C17DRR40001A1	✓	24	C242	5KC32GN9	✓	30	C323	SEE C323A		85
C111-(GE)	SEE CG111		27	C191	5KCR49SN0065	✓	25	C243	5KC32GN9X	✓	30	C323A	182TTGN4068	✓	85
C120	SEE K634B		46	C193	SEE C193A		25	C247	5KC32GN13	✓	195	C323ES	Century	✓	26
C121	SEE K622B		46	C193A	056B17D15555	✓	25	C248	5KCA9PN3036	✓	30	C324A	SEE C324B		85
C122A	SEE C122B		46	C194	5KCR48TN8062	✓	25	C250A	145TFR4378	✓	58	C324B	184TTGN16027	✓	85
C122B	145TTDR16359	✓	46	C196L	Century	✓	192	C250B	145TFR16088	✓	58	C324ES	Century	✓	26
C123	SEE C123C		46	C198L	Century	✓	31	C250-(GE)	SEE G1312		30	C325A	SEE C325C		85
C123B	182TTDW4028	✓	46	C199ES	Century	✓	26	C251	SEE GT1305		69	C325B	215TTGN16027	✓	85
C123C	182TTDW16065	✓	46	C200	5KC35JN12	✓	190	C251-(GE)	SEE CG251		30	C325C	213TTGN16027	✓	85
C124B	SEE C124C		46	C201	143TFR5302	✓	58	C252	SEE GT1308		69	C326A	SEE C326B		85
C124C	184TTDW16068	✓	46	C201A	SEE C201B		58	C252-(GE)	SEE G1316		69	C326B	215TTGN16029	✓	85
C125A	SEE C125B		46	C201B	143TFR16017	✓	58	C253A	SEE GT1311A		69	C327A	254TTGN14042	✓	85
C125B	---		46	C201-(GE)	SEE CG201		190	C254A	SEE GT1314A		69	C327B	254TTGN16034	✓	85
C126A	SEE C126B		46	C202A	145TFR4306	✓	59	C254-(GE)	SEE G1330		30	C328A	SEE C328B		85
C126B	215TTDW16340	✓	46	C202B	145TFR16101	✓	59	C255A	SEE C255B		59	C328B	256TTGN16034	✓	85
C129	5KC35JN23X		190	C202ES	Century	✓	26	C255B	254TFL16078		59	C328-(GE)	SEE J1025		139,201
C133	5KC36MN27X	✓	190	C202-(GE)	SEE G1114		190	C255-(GE)	SEE G1331		30	C329	5KC37FN65X	✓	139
C136	SEE S113		195	C203B	SEE C203C		59	C256A	SEE C256B		59	C330	5KC36JN268X	✓	139,201
C138	5KC46JN0002X	✓	191	C203C	182TTFW16010	✓	59	C256B	256TTFNA16096		59	C330	Century	✓	112
C145	SEE C148A		24	C203-(GE)	SEE G1115		190	C257-(GE)	SEE C1333		59	C331	5KC36JN269X	✓	139
C147	SEE C147A		24	C204B	SEE C204C		59	C260	SEE K640A		30	C331	Century	✓	112
C147A	048B17D11005	✓	24	C204C	184TTFW16012	✓	59	C260-(GE)	SEE CG260		30	C332	5KC39NN50X	✓	139,201
C148	SEE C148A		24	C205A	SEE C205B		59	C261	5KC42GN0014	✓	30	C332	Century	✓	112
C148A	048B17D11015	✓	24	C205B	213TTFWD16012	✓	59	C262	5KC42GN0014X	✓	30	C333	5KC39QN3219X	✓	139
C150A	145TTDR14088	✓	46	C206A	SEE C206B		59	C264	5KC49UN6065	✓	30	C333	Century	✓	112
C150B	145TTDR16085	✓	46	C206B	215TTFWD16010	✓	59	C268	5KC46PN0015	✓	30	C334	5KC39RN44X	✓	139,201
C150L	Century	✓	31	C207A	SEE C207B		59	C269	5KC46PN0015X	✓	30	C335	5KC39RN45X	✓	139
C151L	Century	✓	31	C207B	254TFL16007		59	C271	5KCR48WN6066	✓	30	C336	5KC49NN2140X	✓	139,201
C152A	SEE C152B		46	C208	5KC35FN51X	✓	190	C273	5KC49NN2130X	✓	30	C337	5KC49NN2167X	✓	139
C152B	184TTDW16082	✓	46	C208V1	Century	✓	33	C274	5KC49NN2130Y	✓	30	C337	Century	✓	114
C153	SEE C153A		24	C209	5KC36LN26	✓	190	C275	5KC49TN0034	✓	30	C338	5KC49TN2141X	✓	139,201
C153A	048B17D11004	✓	24	C209	Century	✓	223	C276	5KC49TN0034X	✓	30	C338	Century	✓	114
C153L	Century	✓	33	C210	5KC36LN26X	✓	190	C281	145TFR5337		34	C339	5KC49TN2170X	✓	139
C154	SEE C154A		24	C210	Century	✓	26	C281-(GE)	SEE G1376		30	C339	Century	✓	114
C154A	048B17D11010	✓	24	C210ES	Century	✓	26	C282	145TFR5305		34	C340	5KCR48TN142T	✓	139,201
C155	Century	✓	33	C213	Century	✓	35,224	C282-(GE)	SEE G1377		30	C340	Century	✓	112
C155-(ME)	SEE C155B		46	C215	5KC36LN1	✓	190	C284	145TFR5306		34	C341	5KCR48TN174T	✓	139
C155A	SEE C155B		46	C216	5KC36LN1X	✓	190	C284-(GE)	SEE G1392		31	C341	Century	✓	192
C155B	---		46	C220A	143TFR4329	✓	58	C289	5KC42GN0309X	✓	195	C343	Century	✓	193
C156A	SEE C156B		46	C220B	143TFR16059	✓	58	C292	5KC49TN0285X	✓	195	C344	Century	✓	35
C156B	---		46	C220V1	Century	✓	31	C295	5KC49TN0033	✓	30	C345	Century	✓	112
C157LES	Century	✓	26	C221A	145TFR4332	✓	58	C297	5KCR48WN0292	✓	30	C346	Century	✓	112
C158	SEE C158A		24	C221B	145TFR16353	✓	58	C301A	SEE C301B		85	C347	Century	✓	112
C158A	056B17D11019	✓	24	C221-(GE)	SEE B1316		191	C301B	143TTGN14011		85	C348ES	Century	✓	112
C159	SEE C159A		24	C222	SEE C222A		59	C302A	SEE C302B		85	C349	5KC36LN166X	✓	32
C159A	056B17D11037	✓	24	C222A	145TFR17033	✓	59	C302B	145TTGN16504		85	C349ES	Century	✓	112
C162A	SEE C162B		46	C222ES	Century	✓	26	C303A	SEE C303B		85	C351	5KC49NN2133X	✓	32
C162B	---		46	C223B	SEE C223C		59	C303B	182TTGN16003	✓	85	C352	5KC49NN2135X	✓	139
C162-(GE)	SEE G1098A		24	C223C	182TTFW16042	✓	59	C304A	SEE C304B		85	C354	SEE C354A		28
C163	SEE C123C		46	C223V1	Century	✓	31	C304B	184TTGN16004	✓	85	C354A	056B17D11039	✓	28
C164	SEE C164A		24	C223-(GE)	SEE CG223		190	C305	213TTGS14015	✓	85	C355	SEE G230A		28
C164A	048B17D11003	✓	24	C224	SEE C224B		59	C305B	213TTGND16001	✓	85	C355ES	Century	✓	29
C167	SEE SC167A		24	C224B	184TTFW16046	✓	59	C306	SEE C306B		85	C356	SEE C356A		28
C167A	056B17D11018	✓	24	C225A	SEE C225C		59	C306B	215TTGND16006	✓	85	C356A	056B17D11036	✓	28
C168	SEE C168A		24	C225B	213TTFW16047	✓	59	C307A	SEE C307B		85	C358	SEE G234A		28
C168A	056B17D11030	✓	24	C225C	213TTFWD16047	✓	59	C307B	254TTGN16524		85	C359	SEE C359A		28
C169	5KC49GN0010Y	✓	216	C226A	SEE C226B		59	C308A	SEE C308B		85	C359A	056B17D11033	✓	28
C173	182TCDR8007		28	C226B	215TTFWD16051	✓	59	C308B	256TTGN16004		85	C361	SEE C361A		83
C175	SEE C175A		24	C226	Century	✓	192	C309	Century	✓	192	C361A	143TTGN6551	✓	83
C175A	056B17D15545	✓	24	C227A	SEE C227B		59	C310	Century	✓	110	C361-(GE)	SEE CG361A		28
C176	SEE C176A		24	C227B	254TFL16039	✓	59	C310C	Century	✓	110	C362	SEE C362A		83
C176A	056B17DRR70004A1	✓	24	C230A	SEE C230B		58	C311	Century	✓	110	C362A	145TTGN6536	✓	83
C177	SEE C177A		24	C230B	143TFR16070	✓	58	C311C	Century	✓	110	C362-(GE)	SEE CG362A		28
C177A	056B17DRR70010A1	✓	24	C230-(GE)	SEE CG230		191	C312	Century	✓	110	C363	SEE C363A		83
C178	SEE C178A		24	C231	Century	✓	192	C312C	Century	✓	110	C363A	145TTGN6549	✓	83
C178A	056B11D15506	✓	24	C231-(ME)	SEE C231B		58	C313	Century	✓	110	C363-(GE)	SEE CG363A		28
C179	SEE C179A		24	C231A	SEE C231B		58	C313C	Century	✓	110	C364	SEE C364A		83
C179A	056B34D11014	✓	24	C231B	145TFR16374		58	C314	Century	✓	110	C364A	182TTGN6569	✓	83
C180	SEE C180A		24	C231-(GE)	SEE D1113		191	C314C	Century	✓	110	C365	SEE C365A		83
C180A	056B34D99007	✓	24	C232A	SEE C232B		59	C315ES	Century	✓	28	C365A	184TTGN6575	✓	83
C181	SEE C181A		24	C232B	145TFR16426		59	C316ES	Century	✓	28	C366	SEE C366B		83
C181A	056B17D15542	✓	24	C232-(GE)	SEE CG232		191	C317V1	Century	✓	113	C366A	213TTGN6528	✓	83
C182	SEE C182A		24	C235	5KCA9PN0155	✓	191	C320A	SEE C320B		85	C366B	213TTGND6528	✓	83
C182A	056B17DRR70017A1	✓	24	C236A	SEE C236B		59	C320B	143TTGN16539	✓	85	C366-(GE)	SEE G1511		32
C185	SEE C185A		25	C236B	145TFR16105	✓	59	C320ES	Century	✓	26	C367	SEE C367B		83
C185A	056B17D15548	✓	25	C236-(GE)	SEE CG236		191	C321A	SEE C321B		85	C367A	215TTGN6528	✓	83
C186	SEE C186A		25	C237A	SEE C237B		59	C321B	145TTGN16036	✓	85	C367B	215TTGND6528	✓	83

CAT. NO.	MODEL NO.	STOCK	PAGE NO.	CAT. NO.	MODEL NO.	STOCK	PAGE NO.	CAT. NO.	MODEL NO.	STOCK	PAGE NO.	CAT. NO.	MODEL NO.	STOCK	PAGE NO.
C367-(GE)	SEE G1513		32	C435	Century	✓	192	C702A	056B34D99009	✓	24	C1287	SEE N542		121
C368	SEE C368A		83	C444	5KC36LN144X	✓	34	C703	SEE C703A		25	C1288	SEE N543		121
C368A	182TTGN6536	✓	83	C445	5KC49NN2132X	✓	34	C703A	056B34D15536	✓	25	C1289	SEE N544		121
C368-(GE)	SEE G1515		32	C445ES	Century	✓	28	C704	5KC49PN2521Y	✓	216	C1290	SEE N545		121
C369	SEE C369A		83	C446	5KC42GN0018X	✓	32	C732-(GE)	SEE CG732		139	C1291	5KC46GN0075U	✓	112
C369A	184TTGN6537	✓	83	C448	Century	✓	192	C741V1	Century	✓	192	C1292	5KC46JUN0076U	✓	112
C369-(GE)	SEE G1517		32	C449	5KC37NN160	✓	27	C742V1	Century	✓	192	C1293	5KCR49PN0077U	✓	112
C370	SEE C370B		83	C455	Century	✓	192	C766	Century	✓	193	C1294	5KCR49UN0079U	✓	112
C370A	213TTGN6536	✓	83	C457	5KC37NN14T	✓	190	C770	Century	✓	176	C1295	5KCR49WN0295U	✓	112
C370B	213TTGND6536	✓	83	C457ES	Century	✓	26	C770V1	Century	✓	176	C1296	SEE G212A		28
C370-(GE)	SEE G1519		32	C459	5KC37MN96	✓	24	C771	Century	✓	176	C1297	SEE G256A		28
C371	SEE C371A		83	C460	5KC36LN19X	✓	190	C774ES	Century	✓	26	C1298	5KC46NN0758	✓	24
C371A	215TTGN16534	✓	83	C460ES	Century	✓	26	C775ES	Century	✓	26	C1298A	056B17DRR70012A1	✓	24
C371-(GE)	SEE G1531		32	C462	5KC33KN19	✓	30	C776ES	Century	✓	29	C1302	5KCR49SN0042S	✓	115
C375	5KC42GN0066	✓	34	C465	5KC39QN3218X	✓	139	C782RB	Century	✓	113	C1303	5KCR46NN0264T	✓	115
C376	5KC49TN0067	✓	34	C466	5KCR49TN155T	✓	32	C783	Century	✓	116	C1314	5KCR49PN0492S	✓	115
C380	SEE C380B		61	C474	5KCR49PN3011X	✓	191	C784	Century	✓	176	C1315	5KCR49SN0493S	✓	115
C380B	184TTFW16051	✓	61	C475	5KCR49SN3009	✓	191	C785	Century	✓	176	C1333	5KC49PN6062	✓	30
C381	SEE C381B		61	C476	5KCR49SN3010	✓	191	C786	Century	✓	176	C1336	5KC33FN14180X	✓	139
C381B	182TTFW16021	✓	61	C486	5KCR49PN3012X	✓	191	C806	5KC49PN0281X	✓	195	C1380	SEE C380B		61
C381-(GE)	SEE CG381		25	C490	Century	✓	176	C847	5KC37NN115X	✓	39	C1381	SEE C381B		61
C382	SEE C382B		61	C507	Century	✓	33	C855	5KC49SN2156X	✓	132	C1382	SEE C382B		61
C382B	182TTFW16030	✓	61	C513V1	Century	✓	176	C878	5KCR49TN2164T	✓	139	C1385	SEE C385B		61
C382-(GE)	SEE CG382		219	C523V1	Century	✓	193	C907	Century	✓	33	C1404	5KC49UN6067	✓	32
C383A	182TTFW4345	✓	61	C524	Century	✓	193	C916	Century	✓	33	C1405	5KC35MN145	✓	34
C383B	182TTFW16027	✓	61	C526ES	Century	✓	26	C926	Century	✓	33	C1412	5KCR49WN6078	✓	34
C383-(GE)	SEE CG383		219	C527	Century	✓	192	C1081	5KC39EN2553X	✓	137	C1419	5KC33FN31	✓	32
C384	SEE C384B		61	C548	5KC49PN6051X	✓	190	C1082	5KC39HN2554X	✓	137	C1420	5KC36LN144	✓	34
C384A	213TTFW16078	✓	61	C552	5KC48UN6052X	✓	190	C1083	5KC33MN2555X	✓	137	C1422	SEE C1422A		28
C384B	213TTFWD16078	✓	61	C580	Century	✓	113	C1083A	5KC39PN5105X	✓	137	C1422A	056B11D15504	✓	28
C384-(GE)	SEE CG384		219	C581	Century	✓	113	C1084	5KC39SN2810X	✓	137	C1423	5KCR49MN6063	✓	34
C385	SEE C385B		61	C582	Century	✓	113	C1085	5KCR39SN2557X	✓	137	C1424	5KC49SN2158	✓	32
C385B	184TTFW16006	✓	61	C593	Century	✓	116	C1086	5KCR39UN2558X	✓	137	C1425	5KC49PN0283	✓	34
C386A	SEE C386B		61	C594	Century	✓	116	C1087	5KC39EN2500X	✓	137	C1458	5KC46GN0251	✓	219
C386B	184TTFW16027	✓	61	C595	Century	✓	116	C1088	5KC39HN2501X	✓	137	C1459	5KC46GN0251Y	✓	219
C387A	SEE C387B		61	C596	Century	✓	116	C1089	5KC33MN2502X	✓	137	C1460	5KC46LN0252	✓	219
C387B	184TTFW16029	✓	61	C597	Century	✓	116	C1089A	5KC39PN6200X	✓	137	C1461	5KC46LN0252Y	✓	219
C388	SEE C388B		61	C598	Century	✓	116	C1090	5KC39SN2812X	✓	137	C1462	5KC39HN2888X	✓	137
C388A	215TTFW16079	✓	61	C607	Century	✓	192	C1091	5KCR39SN2504X	✓	137	C1463	5KC33MN2889X	✓	137
C388B	215TTFWD16079	✓	61	C608ES	Century	✓	26	C1092	5KCR39UN2505X	✓	137	C1463A	5KC39PN6201X	✓	137
C389	SEE C389B		61	C612	Century	✓	31	C1104	SEE C104C		46	C1464	5KC39SN2890X	✓	137
C389A	213TTFW16008	✓	61	C613	Century	✓	31	C1105	SEE C105C		46	C1465	5KCR39SN2891X	✓	137
C389B	213TTFWD16008	✓	61	C620	Century	✓	31	C1123	SEE C123C		46	C1466	5KCR39UN2892X	✓	137
C390	SEE C390B		61	C621	Century	✓	193	C1152	5KC39QN3220X	✓	190	C1467	5KC37NN3544T	✓	170
C390A	213TTFW16035	✓	61	C630ES	Century	✓	26	C1153	5KC49GN0022X	✓	190	C1468	5KC49NN2081T	✓	170
C390B	213TTFWD16035	✓	61	C634	Century	✓	192	C1154	5KC38NN413X	✓	191	C1469	5KC49PN0253	✓	219
C391	SEE C391B		61	C635ES	Century	✓	28	C1155	5KC38NN410X	✓	191	C1474	SEE C1474A		24
C391A	213TTFW16036	✓	61	C636	SEE S117		195	C1156	5KC46LN0149X	✓	191	C1474A	056B34D11021	✓	24
C391B	213TTFWD16036	✓	61	C639	Century	✓	216	C1157	5KC39RN383X	✓	191	C1475	SEE C1475A		24
C392	SEE C392B		61	C646	5KC36PNB169	✓	37	C1158	5KC49PN0164X	✓	191	C1475A	056B34D11022	✓	24
C392A	215TTFW16005	✓	61	C654	Century	✓	192	C1159	5KC49RN2152T		191	C1477	SEE C1477A		25
C392B	215TTFWD16005	✓	61	C655ES	Century	✓	26	C1160	5KCR49SN0150X	✓	191	C1477A	056B34D99008	✓	25
C393	SEE C393B		61	C658ES	Century	✓	26	C1161	5KCR49RN2148T	✓	191	C1478	5KCR49SN3009X	✓	191
C393A	215TTFW16041	✓	61	C659	5KCR49WN0566Y	✓	110	C1162	SEE B352		191	C1479	5KCR49TN3084X	✓	191
C393B	215TTFWD16041	✓	61	C660	5KC49TN0568Y	✓	110	C1168	5KC36GN2507X	✓	137	C1480	5KC49PN0161U	✓	216,223
C393-(GE)	SEE CG393		27	C660V1	Century	✓	176	C1169	5KC36MN2508X	✓	137	C1483	5KC46LN0254X	✓	191
C394	SEE C394A		61	C661	5KC46GN0569Y	✓	110	C1170	5KC38PN2509X	✓	137	C1489	5KC46PN0359Y	✓	219
C394A	215TTFW16042	✓	61	C661V1	Century	✓	176	C1171	5KC38SN2510X	✓	137	C1801	5KC49MN6384	✓	37
C400	SEE C400A		109	C662	5KC49SN2418U	✓	110	C1172	5KCR39UN2511X	✓	137	C1802	SEE G650		37
C400A	145TFR16092	✓	109	C662	Century	✓	175	C1173	5KCR39UN2512X	✓	137	C1803	5KC49HN0719	✓	37
C401	145TFR5360	✓	109	C663	5KC49NN2419Y	✓	110	C1187	5KC49NN0224X	✓	191	C1804	SEE G651A		37
C401A	145TFR16360	✓	109	C663	Century	✓	175	C1203	SEE C203C		59	C1805	SEE G652		37
C402	SEE C402A		109	C664	5KC36LN4003Y	✓	110	C1204	SEE C204C		59	C1806	SEE G653		37
C402A	184TTY16076	✓	109	C664	Century	✓	31	C1223	SEE C223C		59	C1807	5KC49QN0716	✓	37
C403	145TFR5359	✓	109	C665ES	Century	✓	28	C1224	SEE C224B		59	C1808	SEE G654A		37
C403A	145TFR16359	✓	109	C666	Century	✓	192	C1238	SEE C238C		59	C1809	5KCR49SN6375	✓	37
C403V1	Century	✓	192	C669	Century	✓	31	C1252	SEE C1252A		24	C1810	SEE G657A		37
C404	SEE C404A		109	C671	Century	✓	31	C1252A	056B11D11003	✓	24	C1811	SEE G659A		37
C404A	184TTY16033	✓	109	C678V1	Century	✓	192	C1258	5KC49PN6051	✓	190	C1812	SEE G853		38
C405	182TTL7034	✓	109	C682ES	Century	✓	26	C1263	SEE C1263A		24	C1813	SEE G854		38
C406	184TTL7041	✓	109	C683	5KC36LN84X	✓	139	C1263A	056B11D15505	✓	24	C1814	5KC49HN2509	✓	38
C407	SEE C407A		109	C683	Century	✓	31	C1264	5KC48UN6052	✓	190	C1815	SEE G855		38
C407A	213TTL16038	✓	109	C685	Century	✓	31	C1269	SEE C1269A		29	C1816	SEE G656		38
C408	215TTL7050	✓	109	C686	Century	✓	31	C1269A	056B34D15537	✓	29	C1817	5KC49SN6380	✓	38
C408A	---	✓	109	C688ES	Century	✓	26	C1270	SEE C1270A		29	C1818	5KC49MN6379	✓	38
C412V1	Century	✓	192	C689ES	Century	✓	26	C1270A	056B34D15538	✓	29	C1904	SEE Z128		110
C419	5KC49PN3027X	✓	190	C691	Century	✓	192	C1273	5KC49SN8060T	✓	170	C1909	5KCR49ZNO785S	✓	115
C420	5KCR49PN3011	✓	191	C692	Century	✓	193	C1274	5KCR49TN8058T	✓	170	CB2024AV1	Century	✓	136
C420ES	Century	✓	26	C693	Century	✓	31	C1275	5KCR49ZNB061T	✓	170	CB2034A	Century	✓	136
C426V1	Century	✓	192	C695ES	Century	✓	26	C1285	SEE N559		121	CB2034AD	Century	✓	136
C431	5KC36LN18	✓	24	C702	SEE C702A		24	C1286	SEE N541		121	CB2054AD	Century	✓	136

Index

Catalog Number/Model Number

INDEX

CAT. NO.	MODEL NO.	STOCK	PAGE NO.	CAT. NO.	MODEL NO.	STOCK	PAGE NO.	CAT. NO.	MODEL NO.	STOCK	PAGE NO.	CAT. NO.	MODEL NO.	STOCK	PAGE NO.
CF100	Century	✓	69	CG381	5KCR49WN0270T	✓	25	D393A	056T34F99008	✓	60	DC155	Century	✓	102
CF101	Century	✓	69	CG382	5KC35GNA488	✓	219	D394	SEE D394A	✓	61	E1204	SEE G063A	✓	39
CF102	Century	✓	69	CG383	5KC35JNA489	✓	219	D394A	056T34F99017	✓	61	E3404	SEE G084A	✓	39
CF103	Century	✓	69	CG384	5KC35JNA489Y	✓	219	D395	SEE D395A	✓	61	E001	SEE GT1105A	✓	63
CF104	Century	✓	69	CG393	5KC36MN20	✓	27	D395A	056T34F99012	✓	61	E002	SEE GT1108A	✓	63
CF105	Century	✓	69	CG732	5KC39RN114T	✓	139	D396	056T34F5306	✓	61	E003	SEE GT1111A	✓	64
CF106	Century	✓	69	CP1072L	Century	✓	216	D396A	056T34F99014	✓	61	E004	SEE GT1114A	✓	64
CF107	Century	✓	69	CP1102L	Century	✓	216	D400	056C17F5352	✓	107	E005	254TTF06081	✓	55
CF108	Century	✓	69	CP1152L	Century	✓	216	D401	056C17F5353	✓	107	E006	SEE GT1120A	✓	65
CF109	Century	✓	69	CP1202L	Century	✓	216	D402	056C17F5354	✓	107	E007	SEE GT1123A	✓	65
CF110	Century	✓	69	CP1302L	Century	✓	216	D403	056C17F5355	✓	107	E008	SEE GT1126A	✓	65
CF111	Century	✓	69	CP1502L	Century	✓	216	D404	056B17F5330	✓	107	E009	SEE GT1129A	✓	66
CF112	Century	✓	69	CP1502LV1	Century	✓	216	D450	056T17F5348	✓	109	E010	SEE GT1132A	✓	66
CF113	Century	✓	69	CPE10	Century	✓	150	D451	056T11F5325	✓	109	E011	SEE GT1133A	✓	66
CF114	Century	✓	69	CPE11	Century	✓	158	D452	056T17F5349	✓	109	E012	SEE GT1135A	✓	66
CF115	Century	✓	69	CPE12	Century	✓	150	D453	056T11F5326	✓	109	E013	SEE GT1136A	✓	66
CF116	Century	✓	69	CPE13	Century	✓	158	D454	056T17F5350	✓	109	E014	SEE GT1138A	✓	67
CF117	Century	✓	69	CPE14	Century	✓	150	D455	056T11F5327	✓	109	E015	SEE GT1139A	✓	67
CF118	Century	✓	69	CPE15	Century	✓	158	D456	056T17F5357	✓	109	E016	SEE GT1142A	✓	67
CF119	Century	✓	69	CPE16	Century	✓	150	D456A	056T17F15655	✓	109	E095	SEE GT4103	✓	146
CFR01	Century	✓	70	CPE17	Century	✓	158	D457	056T17F5358	✓	109	E096	SEE GT0406	✓	146
CFR02	Century	✓	70	CPE18	Century	✓	151	D457A	056T17F15677	✓	109	E097	SEE GT0410	✓	147
CFR03	Century	✓	70	CPE19	Century	✓	159	D1113	5KC46LN0158X	✓	191	E098	SEE E148B	✓	147
CFR04	Century	✓	70	CPE20	Century	✓	151	D1312	---	✓	36	E100	SEE GT0401	✓	146
CFR05	Century	✓	70	CPE21	Century	✓	158	D1313	---	✓	36	E102	SEE GT0404	✓	146
CFR06	Century	✓	70	CPE22	Century	✓	151	D1314	---	✓	36	E104	SEE GT0407	✓	146
CFR07	Century	✓	70	CPE23	Century	✓	159	D1315	---	✓	36	E105	SEE GT0409	✓	147
CFR08	Century	✓	70	CPE24	Century	✓	151	D1316	---	✓	36	E106A	SEE GT0410	✓	147
CFR09	Century	✓	70	CPE25	Century	✓	159	DC104	Century	✓	101	E107A	SEE GT0412	✓	147
CFR10	Century	✓	70	CPE26	Century	✓	151	DC105	Century	✓	101	E108	SEE GT0413	✓	147
CFR11	Century	✓	70	CPE27	Century	✓	159	DC106	Century	✓	101	E109A	SEE GT0415	✓	147
CFR12	Century	✓	70	CPE28	Century	✓	151	DC107	Century	✓	101	E110	SEE GT0416A	✓	147
CFR13	Century	✓	70	CPE29	Century	✓	159	DC108	Century	✓	101	E111	SEE GT0418A	✓	148
CFR14	Century	✓	70	CPE30	Century	✓	151	DC109	Century	✓	101	E112	SEE GT0419A	✓	148
CFR15	Century	✓	71	CPE31	Century	✓	159	DC110	Century	✓	101	E113	215TTDW4022	✓	148
CFR16	Century	✓	71	CPE32	Century	✓	151	DC111	Century	✓	101	E113A	215TTDW4022	✓	148
CFR17	Century	✓	71	CPE33	Century	✓	159	DC112	Century	✓	101	E114A	SEE E114B	✓	148
CFR18	Century	✓	71	CPE34	Century	✓	151	DC114	Century	✓	101	E114B	254TTR16031	✓	148
CFR19	Century	✓	71	CPE35	Century	✓	152	DC115	Century	✓	101	E115	SEE GT2001	✓	146
CFR20	Century	✓	71	CPE36	Century	✓	159	DC116	Century	✓	101	E116	SEE GT0501	✓	146
CFR21	Century	✓	71	CPE37	Century	✓	151	DC117	Century	✓	101	E118	SEE GT4101	✓	146
CFR22	Century	✓	71	CPE38	Century	✓	159	DC118	Century	✓	101	E117	SEE GT4001	✓	146
CFR23	Century	✓	71	CPE39	Century	✓	151	DC119	Century	✓	101	E119	SEE GT4201	✓	146
CFR24	Century	✓	71	D010	056B34D2029	✓	216,223	DC120	Century	✓	101	E120	SEE GT2003	✓	146
CFR25	Century	✓	71	D012	SEE 9035	✓	216	DC121	Century	✓	101	E121	SEE GT0503	✓	146
CFR26	Century	✓	71	D013	SEE 9036	✓	216	DC122	Century	✓	101	E122	SEE GT4003	✓	146
CFR27	Century	✓	71	D014	SEE 9031	✓	216	DC123	Century	✓	101	E123	SEE GT0403	✓	146
CFR28	Century	✓	71	D015	SEE 9032	✓	216,223	DC124	Century	✓	101	E124	SEE GT4203	✓	146
CFR29	Century	✓	71	D017	056B34D5302	✓	216	DC125	Century	✓	101	E125	SEE GT2004	✓	146
CFR30	Century	✓	72	D018	SEE C704	✓	216	DC126	Century	✓	101	E126	SEE GT0504	✓	146
CFR31	Century	✓	72	D019	056B34D15532	✓	216	DC127	Century	✓	101	E127	SEE GT4004	✓	146
CFR32	Century	✓	72	D107	048S17D2017	✓	185	DC128	Century	✓	101	E128	SEE GT4104	✓	146
CFR33	Century	✓	72	D110	SEE C1152	✓	191	DC129	Century	✓	101	E129	SEE GT4204	✓	146
CFR34	Century	✓	72	D111	056C17D2079	✓	190	DC130	Century	✓	101	E130	SEE GT2006	✓	146
CFR35	Century	✓	72	D113	SEE D1113	✓	191	DC131	Century	✓	101	E131	SEE GT0506	✓	146
CFR36	Century	✓	72	D114	SEE C1158	✓	191	DC132	Century	✓	101	E132	SEE GT4006	✓	146
CFR37	Century	✓	72	D115	056B34D2027	✓	191	DC133	Century	✓	101	E133	SEE GT4106	✓	146
CFR38	Century	✓	72	D116	SEE C1161	✓	191	DC134	Century	✓	101	E134	SEE GT4206	✓	146
CFR39	Century	✓	72	D117	SEE C1155	✓	191	DC135	Century	✓	101	E135	SEE GT2007	✓	146
CFR40	Century	✓	72	D118	056C34D2106	✓	191	DC136	Century	✓	101	E136	SEE GT0507	✓	146
CFR41	Century	✓	72	D119	048C17D2055	✓	190	DC142	Century	✓	101	E137	SEE GT4007	✓	146
CFR42	Century	✓	72	D127	SEE 4305	✓	186	DC144	Century	✓	101	E138	SEE GT4107	✓	146
CFR43	Century	✓	72	D129	SEE 4306	✓	186	DC145	Century	✓	101	E139	SEE GT4207	✓	146
CFR44	Century	✓	72	D143	048S17D2086	✓	186	DC146	Century	✓	119	E140	SEE GT2009	✓	147
CG105	SEE CG105	✓	27	D145	SEE H167	✓	186	DC147	Century	✓	119	E141	SEE GT0509	✓	147
CG105A	056B17D11038	✓	27	D149	056S17D2050	✓	187	DC156	Century	✓	119	E142	SEE GT4009	✓	147
CG111	5KC37LN91	✓	27	D162	048S17D2087	✓	187	DC157	Century	✓	119	E143	SEE GT4109	✓	147
CG201	5KC35JN12X	✓	190	D163	048S17D2088	✓	187	DC158	Century	✓	101	E144	SEE GT4209	✓	147
CG223	5KC49GN0001X	✓	190	D164	SEE 4338	✓	187	DC161	Century	✓	101	E145	SEE E145A	✓	147
CG230	5KC46LN0158	✓	191	D180	048S17D7204	✓	185	DC162	Century	✓	101	E145A	---	✓	147
CG232	5KCR49WN6077	✓	191	D181	048S17D7205	✓	186	DC163	Century	✓	101	E146	SEE GT0510	✓	147
CG236	5KC49PN0155X	✓	191	D311	056C34F5301	✓	36	DC164	Century	✓	101	E147A	SEE E147B	✓	147
CG239	5KCR49SN0012X	✓	191	D312	056C34F5302	✓	36	DC165	Century	✓	101	E147B	182TTDW16062	✓	147
CG251	5KC32GN19X	✓	30	D313	056C34F5303	✓	36	DC166	Century	✓	101	E148A	SEE E148B	✓	147
CG260	5KC37RN35	✓	30	D314	056B34F5326	✓	36	DC148	Century	✓	102	E148B	182TTDW16067	✓	147
CG361	SEE CG361A	✓	28	D315	056B34F5327	✓	36	DC149	Century	✓	102	E149A	SEE E149B	✓	147
CG361A	056B17D15544	✓	28	D316	056B34F5328	✓	36	DC150	Century	✓	102	E149B	---	✓	147
CG362	SEE CG362A	✓	28	D390	056T34F5303	✓	60	DC151	Century	✓	102	E150A	SEE E150B	✓	147
CG362A	056B17DRC70002A1	✓	28	D391	056T34F5301	✓	60	DC152	Century	✓	102	E150B	182TTDW16311	✓	147
CG363	SEE CG363A	✓	28	D392	056T34F5302	✓	60	DC153	Century	✓	102	E151	SEE GT0512	✓	147
CG363A	056B17DRC70005A1	✓	28	D393	SEE D393A	✓	60	DC154	Century						

CAT. NO.	MODEL NO.	STOCK	PAGE NO.	CAT. NO.	MODEL NO.	STOCK	PAGE NO.	CAT. NO.	MODEL NO.	STOCK	PAGE NO.	CAT. NO.	MODEL NO.	STOCK	PAGE NO.
E152A	---		147	E204M2	Century	✓	45	E268A	056B17DRR70008A1	✓	29	E327	444TTFN16577		78
E153A	SEE E153B		147	E204-P	215TTFN16057	✓	55	E269	SEE E269A		28	E328	444TTFN6086	✓	57
E153B	182TTDWD16021	✓	147	E204A-P	215TTFND16057	✓	55	E269A	056B17D15550	✓	28	E329	449TTFN16426		57
E154A	SEE E154B		147	E205	254TTFNA6026	✓	55	E270	SEE E270A		29	E331M2	Century	✓	45
E154B	182TTDWD16315		147	E205M2	Century	✓	45	E270A	056B17DRR70005A1	✓	29	E342	445TTFN16004	✓	57
E155	SEE E155A		147	E205-P	254TTFNA16074	✓	55	E271	449TSTFS6003		57	E345	449TTFN16534		78
E155A	184TTDWD16074		147	E206	256TTFNA6026	✓	56	E271-(GE)	SEE EG271A		24	E349	143TTTN6026	✓	53
E156	SEE GT0513		147	E206M2	Century	✓	44	E272	449TSTFS6002	✓	57	E350	SEE E355		53
E157	SEE E157B		147	E206-P	256TTFNA16070	✓	56	E272-(GE)	SEE EG272		191	E350A	---		53
E157B	184TTDWD16072		147	E207	284TTFNA6026	✓	56	E273	449TSTFS6001	✓	57	E351	143TTTN6001	✓	53
E158A	SEE E158B		147	E207M2	Century	✓	44	E273-(GE)	SEE EG273		34	E352A	---		53
E158B	184TTDWD16073	✓	147	E207-P	284TTFNA16070	✓	56	E274	5KCR49PN0100	✓	32	E353	145TTTN6001	✓	54
E159	SEE E159A		147	E208	286TTFNA6026	✓	56	E275	5KCR49PN0099X	✓	34	E355	145TTTN16081	✓	53
E159A	---		147	E208-P	286TTFNA16328	✓	56	E276	449TFS6038	✓	57	E356	143TTFN16008		53
E160	SEE E160A		147	E209	324TTFN6026	✓	56	E276-(GE)	SEE EG276		30	E362	---		78
E160A	---		147	E209-P	324TTFN16066	✓	56	E277	449TFS6037		57	E363	5013LSTFS6595		78
E161	SEE GT0515		147	E210	326TTFN6026	✓	56	E277-(GE)	SEE EG277A		29	E364	5011LSTFS16031		78
E162	SEE E162A		147	E210-P	326TTFN16073	✓	56	E278	SEE G256A		28	E365	---		78
E162A	---		147	E211	364TTFN6036	✓	57	E280	SEE E280A		24	E366	5011LSTFS16033		78
E163A	SEE E163B		147	E212	365TTFN6036	✓	57	E280A	056B17D15549	✓	24	E369	---		78
E163B	184TTDWD16310	✓	147	E213	405TTFN6036	✓	57	E281	5KCR48UN0105X	✓	191	E373	143TTFN6576		75
E164	SEE E164A		147	E214	444TTFN6036	✓	57	E282	449TFS6088		57	E374	143TTFN6526		75
E164A	---		147	E215	445TTFN6036	✓	57	E282-(GE)	SEE EG282		34	E375	143TTFN6563		75
E165	SEE E165A		147	E216	182TTT6001		54	E283	449TFS6087		57	E376	143TTFN16539		75
E165A	---		147	E216M2	Century	✓	44	E283-(GE)	SEE EG283		32	E377	143TTFN6501		75
E166	SEE GT0516A		147	E217M2	Century	✓	44	E284	449TFS6390	✓	57	E378	143TTFN6502		75
E167	SEE E167A		147	E218	213TTT6001		55	E284-(GE)	SEE EG284		34	E379	143TTFN6505		75
E167A	213TTDWD16347		147	E218M2	Century	✓	45	E285	5KCR49UN0108	✓	30	E380	SEE E380A		75
E168	SEE E168A		147	E219M2	Century	✓	45	E286	5KS49HN4595	✓	122	E380A	182TTFN16584		75
E168A	213TTDWD16333		147	E220	254TTFNA6001	✓	55	E287	SEE E276		57	E382	145TTFN6501		76
E169	SEE E169A		147	E221	256TTFNA6001	✓	56	E287-(GE)	SEE N322		122	E383	145TTFN6521		76
E169A	---		147	E222	284TSTFNA6001	✓	56	E288	SEE N320		122	E386	SEE E386A		76
E170	SEE E170A		148	E223	286TSTFNA6001	✓	56	E289	445TTFN6087		57	E386A	145TTFN16632		76
E170A	---		148	E224	324TSTFS6001	✓	56	E290	SEE N310A		122	E388	SEE E388A		76
E171	SEE GT0518A		148	E225	326TSTFS6001	✓	56	E291	449TFS16334		57	E388A	184TTFN6576		76
E172	SEE E172A		148	E226	364TSTFS6001	✓	57	E292	449TFS6065		57	E390	182TTFN6501		76
E172A	---		148	E227	365TSTFS6001	✓	57	E293	449TFS16333	✓	57	E392	182TTFN6505		76
E173	SEE E173A		148	E228	405TSTFS6001	✓	57	E294	SEE N642		123	E392M2	Century	✓	45
E173A	213TTDWD16307	✓	148	E229	444TSTFS6001	✓	57	E295	SEE N644		123	E393M2	Century	✓	45
E174	SEE E174A		148	E230	445TSTFN6001	✓	57	E296	SEE N646A		123	E394M2	Century	✓	44
E174A	---		148	E235	254TTFNA6076	✓	55	E297-(GE)	SEE N647A		123	E395M2	Century	✓	45
E175	SEE E175A		148	E236	256TTFNA6076	✓	55	E300	143TTTN6030		53	E396	213TTFN6501		76
E175A	215TTDWD16364		148	E237	284TTFNA6076	✓	55	E301A	145TTTN16038	✓	53	E397M2	Century	✓	45
E176	SEE GT0519A		148	E238	286TTFNA6076	✓	55	E302-(GE)	SEE N566		124	E400	326TTFN6580		77
E177	SEE E177A		148	E239	324TTFN6076	✓	56	E302	SEE E302A		54	E401	SEE E401A		77
E177A	---		148	E240	326TTFN6076	✓	56	E302A	145TTTN16037	✓	54	E401A	364TTFN16585		77
E178	SEE E178A		148	E241	SEE E241A		56	E302M2	SEE E316M2		45	E402	SEE E402A		77
E178A	215TTDWD16349	✓	148	E241A	364TTFN16083	✓	56	E303	182TTT6030		54	E402A	365TTFN16592		77
E179	SEE E179A		148	E242	SEE E242A		56	E303-(GE)	SEE N567		124	E403	404TTFN6592		77
E179A	---		148	E242A	365TTFN16083	✓	56	E303M2	SEE E331M2		45	E404	405TTFN6587		78
E180	215TTDWD4008		148	E243	404TTFN6086	✓	57	E304-(GE)	SEE N622		124	E405	SEE E405A		78
E181	215TTDWD4009		148	E244	405TTFN6086	✓	57	E305-(GE)	SEE N569		124	E405A	444TTFN16582		78
E182	215TTDWD4010		148	E246	445TTFN6086	✓	57	E306	215TTFN6030		55	E406	445TTFN6590		78
E183	215TTDWD4023	✓	148	E247	445TTFN6038	✓	57	E306-(GE)	SEE N599		124	E407	445TTFN6591		78
E183A	215TTDWD4023	✓	148	E250	SEE E250A		29	E307	254TTFNA6030	✓	55	E407M2	Century	✓	45
E184	215TTDWD4007		148	E250A	056B17D11041	✓	29	E307-(GE)	SEE N623		124	E408	449TTFN6582		78
E185	SEE E185A		148	E251	SEE E251A		28	E308	256TTFNA6030		56	E448	445TTFN6587	✓	78
E185A	---		148	E251A	056B17D11021	✓	28	E308-(GE)	SEE N601		124	E449	445TTFN6505	✓	78
E186	SEE E186A		148	E252	SEE E252A		29	E309	284TTFNA6030	✓	56	E450	SEE E690		78
E186A	---		148	E252A	056B17D11032	✓	29	E309-(GE)	SEE N602A		124	E450M2	Century	✓	45
E187	SEE E187A		148	E253	SEE E253A		24	E310	286TTFNA6030		56	E451M2	Century	✓	45
E187A	---		148	E253A	056B17D11020	✓	24	E310-(GE)	SEE N626A		124	E452M2	Century	✓	45
E188	SEE E188A		148	E254	5KCR46JN0086X	✓	190	E311	324TTFN6030		56	E453	326TTFN6536		77
E188A	254TTDR16027	✓	148	E255	5KCR46JN0087Y	✓	34	E311-(GE)	SEE N627A		124	E454	364TTFN6526		77
E190	254TTDX4007	✓	148	E256	5KCR46JN0088	✓	32	E312	326TTFN6030	✓	56	E455	365TTFN6526	✓	78
E191	254TTDX4006	✓	148	E257	5KCR46JN0087X	✓	34	E312-(GE)	SEE N605		124	E456	405TTFN6526	✓	78
E192	254TTDX4019		148	E258	5KCR46JN0089	✓	30	E313	364TTFN6040	✓	57	E456M2	SEE E452M2A		45
E193	254TTDX4015		148	E259	SEE E259A		29	E314	405TTFN6040	✓	57	E457	444TTFN6526	✓	78
E194	254TTDX4020		148	E259A	056B17D11031		29	E315	365TTFN6040	✓	57	E458	445TTFN6526	✓	78
E195	254TTDX4024		148	E260	SEE E260A		28	E316	SEE E316A		57	E459	445TTFN6528	✓	78
E197	SEE E197A		149	E260A	056B17D11023		28	E316A	444TTFN6044		57	E461	143TTTN6563	✓	75
E197A	256TTDR16026	✓	149	E261	SEE E261A		29	E316M2	Century	✓	45	E462	SEE E462A		75
E198	SEE E198A		149	E261A	056B17D11029	✓	29	E317	445TTFN6037		57	E462A	---		75
E198A	---		149	E262	SEE E262A		24	E317M2	Century	✓	45	E463	143TTTN6502		75
E199	SEE E199A		149	E262A	056B17D11022	✓	24	E319	324TSTFS6005		56	E464	SEE E464A		75
E199A	---		149	E263	5KCR46MN0054X	✓	190	E320	326TSTFS6005		56	E464A	145TTTN16631	✓	75
E202M2	SEE E216M2		44	E264	5KCR46MN0055Y	✓	34	E321	364TSTFS6005		57	E465	182TTT65678		75
E202-P	184TTFN16056	✓	54	E265	5KCR46MN0093	✓	32	E322	365TSTFS6002		57	E466	145TTTN6521		76
E203M2	SEE E218M2		45	E266	5KCR46MN0055X	✓	34	E323	405TSTFS6005		57	E467	SEE E467A		76
E203-P	213TTFN16326	✓	55	E267	5KCR46MN0094	✓	30	E324	444TSTFS16002		57	E467A	145TTTN16628	✓	76
E203A-P	213TTFND16326	✓	55	E268	SEE E268A		29	E326	445TTFN6039		57	E468	184TTFN6582	✓	76

Index

Catalog Number/Model Number

INDEX

CAT. NO.	MODEL NO.	STOCK	PAGE NO.	CAT. NO.	MODEL NO.	STOCK	PAGE NO.	CAT. NO.	MODEL NO.	STOCK	PAGE NO.	CAT. NO.	MODEL NO.	STOCK	PAGE NO.
E470	182TTTS6538	✓	76	E585M2	Century	✓	45	E653	145TTTN6501	✓	76	E725A	SEE U773		42
E471	213TTF6594	✓	76	E586M2	Century	✓	45	E654	SEE E654A		76	E725B	SEE U773		42
E471A	213TTFND6594	✓	76	E588	445TTGN6538	✓	88	E654A	145TTTN16629	✓	76	E726	SEE GT0073		50
E472	184TTF6810	✓	76	E591	449TTGS16537	✓	88	E655	184TTF6505	✓	76	E727	SEE U777		43
E473	184TTF6844	✓	76	E594	405TTGS6548	✓	88	E656	213TTT6505	✓	76	E728	SEE U265		40
E474	215TTF6881	✓	76	E595	SEE E595A		88	E656A	213TTTND6505	✓	76	E729	SEE U1266		40
E474A	215TTFND6881	✓	76	E595A	449TSTGS16506		88	E657	215TTF6505		76	E730	SEE U1267		40
E475	213TTS6502	✓	76	E596	449TTGS16554		88	E658	254TTFNA6503		77	E731	SEE U268		41
E475A	213TTTND6502	✓	76	E601	182TTT6501	✓	76	E659	256TTFNA6503	✓	77	E732	SEE U269		41
E476	213TTF6531	✓	76	E602	184TTF6501	✓	76	E660	284TSTFNA6502		77	E733	SEE E733A		41
E476A	213TTFND6531	✓	76	E603	213TTT6501	✓	76	E662	324TSTFS6505		77	E733A	254TDX16082	✓	41
E477	254TTFNA6590	✓	76	E603A	213TTTND6501	✓	76	E663	326TSTFS6502		77	E734	SEE E734A		42
E478	215TTF6807	✓	76	E604	215TTF6501	✓	76	E664	364TSTFS6505		77	E734A	256TDX16078	✓	42
E479	215TTF6527	✓	76	E604A	215TTFND6501	✓	76	E665	365TSTFS6502	✓	78	E735	SEE U256		42
E479A	215TTFND6527	✓	76	E605	254TTFNA6501	✓	77	E666	143TTTN6530	✓	75	E736	SEE U257		42
E479-P	215TTFN16847	✓	76	E606	256TTFNA6501	✓	77	E667	SEE E667A		75	E737	SEE U798		42
E480	256TTFNA6596	✓	76	E607	284TSTFNA6501	✓	77	E667A	145TTTN16637		75	E738	SEE U799		42
E481	254TTFNA6515	✓	77	E608	286TSTFNA6501	✓	77	E668	SEE E668A		76	E739	SEE GT0081		50
E482	254TTFNA6529	✓	77	E609	324TSTFS6501	✓	77	E668A	145TTTN16632		76	E740	SEE U1783		43
E483	284TTFNA6876	✓	77	E610	326TSTFS6501	✓	77	E669	182TTTS6530	✓	76	E741	SEE E922		43
E484	256TTFNA6523	✓	77	E611	364TSTFS6501	✓	77	E670	184TTF6530	✓	76	E742	SEE E923		43
E485	256TTFNA6529	✓	77	E612	365TSTFS6501	✓	78	E671	213TTF6530	✓	76	E743	SEE E924		43
E486	286TTFNA6876	✓	77	E613	405TSTFS6501	✓	78	E671A	213TTFND6530	✓	76	E744	SEE E925		43
E488	284TTFNA6837	✓	77	E614	444TSTFS6501	✓	78	E672	215TTF6530	✓	76	E745	SEE E745A		43
E490	286TSTFNA6804	✓	77	E615	445TSTFNA6501	✓	78	E672A	215TTFND6530	✓	76	E745A	447TTDN16058		43
E491	286TTFNA6570	✓	77	E616	182TTTS6526	✓	76	E673	254TTFNA6528	✓	77	E746	SEE U1927		42
E493	405TSTFS6502	✓	78	E617	184TTF6526	✓	76	E674	256TTFNA6528	✓	77	E747	SEE U1928		43
E494	444TSTFS6505	✓	78	E618	213TTF6526	✓	76	E675	284TTFNA6527	✓	77	E748	SEE U270		43
E494M2	Century	✓	45	E618A	213TTFND6526	✓	76	E676	286TTFNA6527	✓	77	E749	SEE U271		43
E495	445TSTFNA6502	✓	78	E619	215TTF6526	✓	76	E677	324TTF6527	✓	77	E750	SEE U272		43
E495M2	Century	✓	45	E619A	215TTFND6526	✓	76	E678	326TTF6527	✓	77	E753	SEE U1784		43
E496	445TSTFNA6506	✓	78	E620	254TTFNA6526	✓	77	E679	364TTF6537	✓	77	E754	SEE U250		43
E496M2	Century	✓	45	E620-P	254TTFNA16838	✓	77	E680	365TTF6537	✓	78	E755	SEE U251		43
E497M2	Century	✓	45	E621	256TTFNA6526	✓	77	E681	405TTF6538	✓	78	E756	SEE U252		43
E499	145TTFN16592	✓	75	E621-P	256TTFNA16855	✓	77	E682	445TTFN6537	✓	78	E757	SEE U785		43
E500	254TTGN6576	✓	87	E622	284TTFNA6526	✓	77	E683	215TTF6580	✓	76	E758	SEE E758A		41
E501	256TTGN6576	✓	87	E622-P	284TTFNA16851	✓	77	E684	254TTFNA6578	✓	76	E758A	213TDDW6030		41
E502	254TTGN6507	✓	87	E623	286TTFNA6526	✓	77	E685	256TTFNA6578	✓	76	E759	SEE E759A		42
E503	254TTGN6531	✓	87	E623-P	286TTFNA16847	✓	77	E687	449TTF6588	✓	78	E759A	215TDDW16345		42
E503-P	254TTGN16549	✓	87	E624	324TTF6526	✓	77	E688	449TTF6587	✓	78	E760	SEE E760A		42
E504	284TTGN6576	✓	87	E624-P	324TTF16860	✓	77	E690	449TTF6538	✓	78	E760A	---		42
E505	256TTGN16509	✓	87	E625	326TTF6526	✓	77	E691	449TTF6537	✓	78	E761	SEE E761A		42
E506	256TTGN6531	✓	87	E625-P	326TTF16844	✓	77	E692	449TTF6536	✓	78	E761A	---		42
E506-P	256TTGN16552	✓	87	E626	364TTF6536	✓	77	E694	284TTFNA6580	✓	77	E762	SEE E762A		42
E507	286TTGN16577	✓	87	E626-P	364TTF16833	✓	77	E695	286TTFNA6580	✓	77	E762A	284TTDC6029	✓	42
E513M2	Century	✓	45	E627	365TTF6536	✓	78	E696	324TTF6577	✓	77	E763	SEE E763A		42
E514M2	Century	✓	45	E627-P	365TTF16862	✓	78	E697	444TTF6540	✓	78	E763A	286TTDC6029	✓	42
E515M2	Century	✓	45	E628	405TTF6536	✓	78	E698	449TSTFS6502	✓	78	E764	SEE E764A		42
E516M2	Century	✓	45	E628-P	405TTF16865	✓	78	E699	449TSTFS6503	✓	78	E764A	324TTDC6029	✓	42
E545M2	SEE E513M2	✓	45	E629	444TTF6536	✓	78	E702	SEE U246		40	E765	SEE E765A		43
E546	284TSTGN6503	✓	87	E629-P	444TTFN16574	✓	78	E704	SEE GT0012A		48	E765A	326TTDC6029	✓	43
E547	284TTGN6533	✓	87	E630	445TTFN6536	✓	78	E705	SEE U249A		41	E766	SEE E766A		43
E547-P	284TTGN16550	✓	87	E631	445TTFN6538	✓	78	E706	SEE E706A		41	E766A	365TTDS16067		43
E563	286TSTGN6501	✓	87	E632	182TTTS6576	✓	75	E706A	213TDDW16310		41	E767	SEE E767A		43
E564	286TTGN6537	✓	87	E633	184TTTS6576	✓	76	E707	SEE U766		42	E767A	365TTDS16064		43
E564-P	286TTGN16546	✓	87	E634	213TTF6576	✓	76	E708	SEE E708A		42	E768	SEE E768C		43
E565	326TTGS6578	✓	87	E634A	213TTFND6576	✓	76	E708A	254TDX16010	✓	42	E768C	365TTDS16042	✓	43
E566	324TSTGS6501	✓	87	E635	215TTF6576	✓	76	E709	SEE E709A		42	E769	449TSTFS6501	✓	78
E567	324TTGS6529	✓	87	E635A	215TTFND6576	✓	76	E709A	256TTDX16006	✓	42	E770	449TTF6530	✓	78
E567-P	324TTGS16541	✓	87	E636	254TTFNA6576	✓	76	E710	SEE GT0069		49	E771	449TTF6528	✓	78
E568	SEE E568A		87	E637	256TTFNA6576	✓	76	E711	SEE GT0072		50	E772	449TTF6527	✓	78
E568A	364TTGS16577	✓	87	E638	284TTFNA6576	✓	77	E712	SEE GT0076		50	E773	449TTF6578	✓	78
E569	326TSTGS6501	✓	88	E639	286TTFNA6576	✓	77	E713	SEE GT0080		50	E774	449TTF6577	✓	78
E570	326TTGS6532	✓	88	E640	324TTF6576	✓	77	E714	SEE U1782		43	E775	449TTF16553	✓	78
E570-P	326TTGS16546	✓	88	E641	326TTF6576	✓	77	E715	SEE U758		40	E776	---		78
E571	365TTGS16577	✓	88	E642	SEE E642A		77	E716	SEE U759		40	E780	SEE E780A		43
E572	364TSTGS6506	✓	88	E642A	364TTF16584	✓	77	E717	SEE U760		40	E780A	404TSTDS16036	✓	43
E573	SEE E573A		88	E643	SEE E643A		77	E718	SEE GT0010A		48	E781	SEE E781A		43
E573A	364TTGS16536	✓	88	E643A	365TTF16591	✓	77	E718A	SEE GT0010A		48	E781A	405TSTDS16038	✓	43
E574	404TTGS6588	✓	88	E644	404TTF6586	✓	77	E719	SEE E719A		41	E782	SEE E782C		43
E575	365TSTGS16503	✓	88	E645	405TTF6586	✓	78	E719A	184TDDW6026		41	E782C	365TSTDS16041	✓	43
E576	SEE E576A		88	E646	SEE E646A		78	E720A	SEE E720B		41	E783	SEE E783A		40
E576A	365TTGS16540	✓	88	E646A	444TTFN16581	✓	78	E720B	213TDDW16330		41	E783A	143TTDR6313	✓	40
E577	405TTF6589	✓	88	E647	445TTFN6586	✓	78	E721	SEE GT0019A		49	E784	SEE U247		41
E578	405TSTGS6503	✓	88	E648	143TTTN6576	✓	75	E721A	SEE GT0019A		49	E785	SEE E785A		40
E580A	444TTGN16580	✓	88	E649	143TTTN6526	✓	75	E722	SEE E722A		42	E785A	145TTDR16089		40
E582A	444TTGN16532	✓	88	E650	SEE E650A		75	E722A	254TDX16042	✓	42	E786	SEE E786A		42
E583	445TTGN6597	✓	88	E650A	---		75	E722A-P	254TDX16043	✓	42	E786A	256TTDR16010	✓	42
E584	445TSTGN16505	✓	88	E651	143TTTN6501	✓	75	E723A	SEE E723B		42	E787	324TTDR4030	✓	42
E584M2	Century	✓	45	E652	SEE E652A		75	E723B	256TTDX16032	✓	42	E787A	324TTDR16054	✓	42
E585	445TTGN6542	✓	88	E652A	145TTTN16630	✓	75	E723B-P	256TTDX16033	✓	42	E788	SEE E788A		42

CAT. NO.	MODEL NO.	STOCK	PAGE NO.	CAT. NO.	MODEL NO.	STOCK	PAGE NO.	CAT. NO.	MODEL NO.	STOCK	PAGE NO.	CAT. NO.	MODEL NO.	STOCK	PAGE NO.
E788A	215TTDWD4003	✓	42	E843	SEE E2131		54	E939A	213TTDWD16314		41	E1730	SEE U1267		40
E789	SEE E789A		42	E844	145TTN4005		54	E950	SEE E2101		53	E1739	SEE U1779		43
E789A	326TSTDP16032	✓	42	E845	SEE E2157		54	E951	SEE E2104		53	E1740	SEE U1783		43
E790	SEE E790A		43	E846	SEE GT1007		63	E952	SEE E2107		54	E1768	SEE E768C		43
E790A	326TTDR16073		43	E847	SEE E2132		54	E953	SEE E2110		54	E1782	SEE E782C		43
E791	SEE E791A		43	E848	SEE E302A		54	E954	SEE E2113		54	E1799	SEE E799B		40
E791A	326TSTDR16034	✓	43	E849	SEE GT1008A		63	E955	SEE E2116A		55	E1904	SEE E904B		41
E791A-P	326TTDR16063	✓	43	E849A	SEE GT1008A		63	E957	SEE GT1043A		67	E1905	SEE E905B		41
E792	SEE E792A		43	E851	143TTN6505		75	E957A	SEE GT1043A		67	E1915	SEE E915B		41
E792A	444TSTDS16038	✓	43	E852	145TTN6505		76	E958	SEE E289		57	E1916	SEE E916B		41
E793	SEE E793A		42	E853	182TTTS6505		76	E959	SEE E213		57	E1930	182TTDWD6030	✓	41
E793A	284TSTDN16031		42	E854	449TTFS6540	✓	78	E960	SEE GT1039A		67	E1930-P	182TTDWD16063	✓	41
E794	SEE E794A		42	E856	449TTFS6564	✓	78	E960A	SEE GT1039A		67	E1931	184TTDWD6031	✓	41
E794A	286TSTDN16036		42	E858	145TFN16593	✓	75	E961C	SEE GT1028A		66	E1931-P	184TTDWD16061	✓	41
E795	SEE U273		43	E901	SEE E901A		39	E962	SEE GT1037A		66	E1955	SEE E2116A		55
E796	SEE E796A		43	E901A	143TTDR16056	✓	39	E962B	SEE GT1037A		66	E1956	SEE E2119A		55
E796A	447TTDN16083		43	E902	SEE E902A		40	E963	SEE E2112		54	E1961	SEE GT1028A		66
E797	SEE E797A		43	E902A	145TTDR16355	✓	40	E964	SEE GT1030A		66	E1962	SEE GT1037A		66
E797A	447TTDN16085		43	E903	SEE E903A		40	E964A	SEE GT1030A		66	E1963	SEE E2112		54
E798	SEE E798A		40	E903A	145TTDR16356	✓	40	E965	SEE E2124		56	E1967	SEE E2109		54
E798A	143TTDR16005	✓	40	E904	SEE E904B		41	E966	SEE GT1032A		66	E1982	SEE E2105		53
E799	SEE E799B		40	E904B	182TTDWD16064		41	E966A	SEE GT1032A		66	E1983	SEE E983B		56
E799B	182TTDWD16090	✓	40	E905B	184TTDWD16071	✓	41	E967	SEE E2109		54	E1984	SEE GT1034A		66
E800	SEE GT1128A		66	E906A	SEE E906B		41	E968	SEE GT1026A		65	E1985	SEE GT1040A		67
E800A	284TTFC6031	✓	56	E906B	213TTDWD16334		41	E968A	SEE GT1026A		65	E1995	SEE E2108		54
E801	SEE E801A		56	E907	SEE E907A		41	E969	SEE E2118A		55	E2000	056734F5940	✓	62
E801A	326TSTFC6036	✓	56	E907A	215TTDWD16346	✓	41	E970	SEE E2114A		54	E2001	SEE E2001A		62
E802A	SEE GT1040A		67	E908	SEE E908A		42	E971	SEE GT1033A		66	E2001A	143TTRF16053	✓	62
E803	SEE E243		57	E908A	254TTDR16029	✓	42	E971A	SEE GT1033A		66	E2002	145TTRF6078	✓	62
E804	SEE E804A		57	E909	SEE E909A		42	E972	SEE E2115A		55	E2003	143TTRF5582	✓	62
E804A	365TSTFC6026	✓	57	E909A	256TTDR16027	✓	42	E973	SEE E2120		55	E2004	SEE E2004A		62
E805A	SEE GT1143A		67	E910	SEE E910A		42	E974	SEE E2123		56	E2004A	145TTRF16331	✓	62
E806	SEE E244		57	E910A	284TTDN16052	✓	42	E975	SEE GT1027A		65	E2005	182TTFW6076	✓	62
E807	SEE E228		57	E911	SEE E911A		42	E975A	SEE GT1027A		65	E2006	145TTRF3002	✓	62
E808	SEE E808A		57	E911A	286TTDN16073	✓	42	E976	SEE GT1036A		66	E2007	SEE E2007A		62
E808A	405TSTFS16033	✓	57	E912	SEE E912A		40	E976A	SEE GT1036A		66	E2007A	145TTRF16329	✓	62
E809	SEE E328		57	E912A	143TTDR16037	✓	40	E977	SEE E2121		55	E2008	184TTFW6076	✓	62
E810	SEE E810A		57	E913	SEE E913A		40	E978	SEE E978A		55	E2009	182TTFW6001	✓	62
E810A	444TSTFN16033	✓	57	E913A	145TTDR16061	✓	40	E978A	284TTF6077	✓	55	E2010	182TTFW6026	✓	62
E811	SEE E811A		57	E914	SEE E914A		40	E979	SEE E2102		53	E2011	213TTFW6076	✓	62
E811A	445TSTFN6026	✓	57	E914A	145TTDR16062	✓	40	E980	SEE E2111A		54	E2011A	213TTFW6076	✓	62
E812	SEE E342		57	E915B	182TTDWD16029	✓	41	E981	SEE E230		57	E2012	184TTFW6001	✓	62
E813	SEE E813A		57	E916B	184TTDWD16040	✓	41	E982	SEE E2105		53	E2013	184TTFW6026	✓	62
E813A	445TSTFN16033	✓	57	E917	SEE E917A		40	E983A	SEE E983B		56	E2014	215TTFW6076	✓	62
E814	SEE E814A		57	E917A	143TTDR16024		40	E983B	286TTF6027	✓	56	E2014A	215TTFW6076	✓	62
E814A	449TTF16094		57	E918	SEE E918A		40	E984	SEE GT1034A		66	E2015	213TTFW6001	✓	62
E815A	SEE GT1134A		66	E918A	184TTDWD16083		40	E984B	SEE GT1034A		66	E2015A	213TTFW6001	✓	62
E816	SEE E816A		56	E919	SEE E919A		41	E985	SEE GT1040A		67	E2016A	213TTFW16039	✓	62
E816A	324TSTFC6036	✓	56	E919A	---		41	E985B	SEE GT1040A		67	E2016B	213TTFWD16039	✓	62
E817	SEE E817A		56	E920A	365TTDS16326		43	E986	SEE E215		57	E2018	215TTFW6001	✓	62
E817A	286TTF6031	✓	56	E921	365TTDS6060		43	E987	SEE E214		57	E2018A	215TTFW6001	✓	62
E818	SEE E818A		56	E922	404TTDS6060	✓	43	E988	SEE GT1035A		66	E2019	215TTFW6026	✓	62
E818A	286TSTFC6036	✓	56	E923	405TTDS6060	✓	43	E988A	SEE GT1035A		66	E2019A	215TTFW16047	✓	62
E819	286TSTFPA4005	✓	56	E923M2	Century	✓	44	E989	SEE E247		57	E2019B	215TTFWD16047	✓	62
E820A	SEE GT1029A		66	E924	444TTDS6060	✓	43	E991	SEE E991A		57	E2100	056734F15940	✓	53
E821	SEE E2143		55	E924M2	Century	✓	45	E991A	365TSTFC6003	✓	57	E2101	143TTRF15642	✓	53
E822	SEE E822A		55	E925	445TTDS6060	✓	43	E992	SEE E229		57	E2102	145TTRF16078	✓	53
E822A	215TTFWD16052	✓	55	E925M2	Century	✓	45	E993	SEE E993A		56	E2103	143TTRF15582	✓	53
E823A	SEE GT1005A		63	E926M2	Century	✓	45	E993A	365TTF6087	✓	56	E2104	145TTRF16033	✓	53
E824	143TTRF4028	✓	53	E927A	143TTDR16055	✓	39	E994	SEE E2106		54	E2105	182TTFW16076	✓	53
E825	SEE E825A		53	E927M2	Century	✓	45	E995	SEE E2108		54	E2106	145TTRF13002	✓	54
E825A	143TTTN16041		53	E928A	145TTDR16351	✓	40	E996	SEE E2122		55	E2107	145TTRF16035	✓	54
E826	SEE E349		53	E928M2	Century	✓	45	E997	SEE E2147		55	E2108	184TTFW16076	✓	54
E827	SEE E2126		53	E929A	145TTDR16352	✓	40	E998	SEE E2149		56	E2109	182TTFW16001	✓	54
E828	SEE E300		53	E929M2	Century	✓	45	E999	SEE E999A		56	E2110	182TTFW16026	✓	54
E829	SEE E355		53	E930M2	Century	✓	45	E999A	284TSTFC6036	✓	56	E2111	213TTFW16076	✓	54
E830	SEE E2153		53	E931	SEE E1931		41	E1002	284TDR16077	✓	42	E2111A	213TTFWD16076	✓	54
E831	SEE E356		53	E932	SEE E932A		41	E1006	284TDR16047	✓	42	E2112	184TTFW16001	✓	54
E831A	---		53	E932A	145TTDR16010	✓	41	E1006-P	284TDR16048	✓	42	E2113	184TTFW16026	✓	54
E832	SEE E2103		53	E933	SEE E933A		41	E1008	284TSDR16003	✓	42	E2114	215TTFW16076	✓	54
E833	SEE E351		53	E933A	182TTDWD16316		41	E1009	286TDR16037	✓	42	E2114A	215TTFWD16076	✓	54
E834	SEE E2128		53	E934	SEE E934A		40	E1009-P	286TDR16038	✓	42	E2115	213TTFW16001	✓	55
E835	143TTN4005		53	E934A	145TTDR16077	✓	40	E1010	286TSDR16002	✓	42	E2115A	213TTFWD16001	✓	55
E836	145TTRF4029	✓	53	E935	215TTDWD4078	✓	41	E1704	SEE U1248		41	E2116	213TTFW16026	✓	55
E837	145TTTC4026	✓	53	E935A	215TTDWD16087	✓	41	E1705	SEE U249A		41	E2116A	213TTFWD16026	✓	55
E838	SEE E2129		53	E936	SEE U280		41	E1718	SEE E1930		41	E2117	254TFL16076	✓	55
E839	145TTN4035	✓	53	E937A	SEE E937B		41	E1719	SEE E719A		41	E2118	215TTFW16001	✓	55
E840	SEE E2156		54	E937B	184TTDWD16315		41	E1724	SEE U771		42	E2118A	215TTFWD16001	✓	55
E841	SEE E841A		54	E938	SEE E938A		41	E1726	SEE GT0073		50	E2119	215TTFW16026	✓	55
E841A	---		54	E938A	184TTDWD16027	✓	41	E1727	SEE U777		43	E2119A	215TTFWD16026	✓	55
E842	SEE E353		54	E939	SEE E939A		41	E1729	SEE U1266		40	E2120	256TFL16076	✓	55

Index

Catalog Number/Model Number

INDEX

CAT. NO.	MODEL NO.	STOCK	PAGE NO.	CAT. NO.	MODEL NO.	STOCK	PAGE NO.	CAT. NO.	MODEL NO.	STOCK	PAGE NO.	CAT. NO.	MODEL NO.	STOCK	PAGE NO.
E2121	254TFL16001	✓	55	F13E1	SEE F101		110	G061	SEE G061A		39	G230	SEE G230A		28
E2122	254TFL16026	✓	55	F15E1	5KCR48WN0292Y		110	G061A	056T11D11005		39	G230A	056B17D11014	✓	28
E2122-P	254TFL16036	✓	55	F34E1	SEE F103		110	G062	SEE G062A		39	G232	SEE G232A		28
E2123	256TFL16002	✓	56	F100	SEE F105		110	G062A	056T17D11044	✓	39	G232A	056B34D11017	✓	28
E2124	256TFL16033	✓	56	F101	056C17F5324	✓	110	G063	SEE G063A		39	G234	SEE G234A		28
E2124-P	256TFL16038	✓	56	F102	056C17F5325	✓	110	G063A	056T17D15908	✓	39	G234A	056B17D11017	✓	28
E2125	056T34F16020		53	F103	056C17F5326	✓	110	G065	056T17D2112	✓	39	G238	SEE G238A		28
E2126	143TFR16040	✓	53	F104	056C17F5327	✓	110	G065A	056T17D11043	✓	39	G238A	056B34D11016	✓	28
E2127	145TFR16080		53	F105	056B17F5307	✓	110	G067	SEE G067A		39	G240	SEE G215		46,140,201
E2128	143TFR16020		53	F107	SEE C1468		170	G067A	056T11D15522	✓	39	G241	056T34D5326		46
E2129	145TFR16040	✓	53	F108	SEE C1273		170	G076	SEE C147A		24	G242	SEE G242A		46
E2130	182TFW16080	✓	53	F109	SEE C1274		170	G078	SEE G078A		24	G242A	056T17D11045	✓	46
E2131	145TFR16020		54	F110	SEE C1275		170	G078A	048B17D11017	✓	24	G243	056T17D2116	✓	46
E2132	145TFR16045	✓	54	F120	SEE C1467		170	G080	SEE G080A		39	G243A	056T17D11042	✓	46
E2133	184TFW16081		54	F131	056C17F5358	✓	34,110	G080A	056T34D15593	✓	39	G244	SEE G244A		46
E2134	182TFW16020	✓	54	F132	056C17F5912	✓	34,110	G082	SEE G082A		39	G244A	056T17D11048		46
E2135	182TFW16040	✓	54	F133	056C17F5913	✓	34,110	G082A	056T17D11041	✓	39	G245	SEE K247A		46
E2136	213TFW16081		54	F134	056C17F5914	✓	34,110	G084	SEE G084A		39	G248	SEE K1299A		46
E2137	184TFW16020	✓	54	F135	056B17F5584	✓	34,110	G084A	056T17D11055	✓	39	G250	SEE CG361A		28
E2138	184TFW16040	✓	54	F201	SEE HG646		112	G086	056T17D2110	✓	39	G254	SEE G254A		28
E2139	215TFW16080		54	F202	SEE C1292		112	G086A	056T17D11040	✓	39	G254A	056B34D11015	✓	28
E2140	213TFW16020		55	F203	SEE C1293		112	G088	SEE G088A		39	G256	SEE G256A		28
E2141	213TFW16040	✓	55	F204	SEE C1294		112	G088A	056T11D15525		39	G256A	056B17D15543	✓	28
E2142	254TFL16077		55	F205	SEE C1295		112	G091	SEE G091A		24	G258	SEE G258A		28
E2143	215TFW16020		55	F252	Century	✓	199	G091A	048B34D11002		24	G258A	056B34D11013		28
E2144	215TFW16040	✓	55	F260	Century	✓	222	G093	SEE C158A		24	G270	SEE G270A		28
E2145	256TFL16077		55	F261	Century	✓	222	G094	SEE C159A		24	G270A	056B17D15541	✓	28
E2146	254TFL16020		55	F262	Century	✓	199	G095	SEE G095A		24	G272	SEE G272A		28
E2147	254TFL16040	✓	55	F263	Century	✓	199	G095A	056B17D11034	✓	24	G272A	056B34D15528	✓	28
E2148	256TFL16020		56	F264V1	Century	✓	222	G096	SEE C1252A		24	G274	SEE G274A		28
E2149	256TFL16040	✓	56	F265	Century	✓	222	G098	SEE G1098A		24	G274A	056B17D15554	✓	28
E2150	056T34F16001		53	F266	Century	✓	222	G100	056T17D2101	✓	196	G278	056C11D5304	✓	199
E2151	143TFR16038	✓	53	F267	Century	✓	222	G101	056T17D2099	✓	196	G289	SEE G289A		46
E2152	145TFR15581		53	F268V1	Century	✓	222	G106	056T17D2104	✓	196	G289A	056T34D15597		46
E2153	143TFR16001		53	F269	Century	✓	222	G107	SEE K1408		196	G290	056B17D5328	✓	223
E2154	145TFR16038	✓	53	F270	Century	✓	199	G109	SEE K381		196	G294	056B34D5307		223
E2155	182TFW16082		53	F271	Century	✓	199	G114	SEE G1114		190	G301	SEE K321		52
E2156	145TFR16001		54	F273	Century	✓	199	G115	SEE G1115		190	G303	SEE K154		52
E2157	145TFR16039	✓	54	F274	Century	✓	199	G120	SEE K278		196	G304	056T17F2043	✓	52
E2158	184TFW16079		54	F276V1	Century	✓	199	G122	056T17D5329	✓	196	G306	SEE K155		52
E2159	182TFW16002	✓	54	F340	Century	✓	188	G126	SEE K1415		196	G308	056T34F5328	✓	52
E2160	182TFW16038	✓	54	F341	Century	✓	194	G127	056T17D5332	✓	196	G309	056T34F5333	✓	52
E2161	213TFW16082		54	F344V1	Century	✓	188	G128	SEE K1418		196	G312	SEE G1312		30
E2162	184TFW16002	✓	54	F352	Century	✓	194	G135	056C17D2088	✓	190	G314	056C17F2052	✓	30
E2163	184TFW16038	✓	54	F352V1	Century	✓	194	G140	056T17D5345	✓	196	G316	SEE G1316		30
E2164	215TFW16081		54	F353	Century	✓	194	G141	056T17D5346	✓	196	G321	SEE K158		52
E2201-P	143TFN16040	✓	53	F387	Century	✓	188	G142	056T17D5347	✓	196	G322	SEE K426		52
E2204-P	145TFN16046	✓	53	F390	Century	✓	188	G143	056T17D5348	✓	196	G324	SEE K159		52
E2207-P	145TFN16045	✓	54	F391	Century	✓	189	G144	056T17D5349	✓	196	G326	SEE K160		53
E2210-P	182TFN16047	✓	54	F392	Century	✓	199	G145	056T17D5350	✓	196	G327	056T34F5334	✓	53
EC1054AV1	Century	✓	33	F393L	Century	✓	199	G151	056C17D2025	✓	190	G328	056T17F2045		53
EC1074AL	Century	✓	33	F394	Century	✓	199	G156	056B17D2012	✓	191	G329	SEE K161		53
EG271	SEE EG271A		24	F395	Century	✓	199	G161	056T17D5701		196	G330	SEE G1330		30
EG271A	056B17D15551	✓	24	F396L	Century	✓	199	G162	056T17D2121	✓	196	G331	SEE G1331		30
EG272	5KCR49PN0098X	✓	191	F500L	Century	✓	113	G165	SEE K544		196	G332	056C17F2049	✓	30
EG273	5KCR49PN0099Y	✓	34	F501	Century	✓	113	G166	SEE K546		196	G333	SEE C1333		30
EG276	5KCR49PN0101	✓	30	F502	Century	✓	113	G167	SEE K1409		196	G337	SEE C261		30
EG277	SEE EG277A		29	F661	Century	✓	189	G168	SEE K279		196	G338	SEE C262		30
EG277A	056B17DRR70019A1		29	F680	Century	✓	189	G169	SEE K280		196	G339	056C17F2051	✓	30
EG282	5KCR49UN0106Y	✓	34	F681	Century	✓	189	G180	SEE K1411		196	G340	SEE G1340		53
EG283	5KCR49UN0107	✓	32	F683	Century	✓	116	G181	SEE K518		196	G342	SEE K162		53
EG284	5KCR49UN0106X	✓	34	F684	Century	✓	116	G182	SEE K519		196	G344	SEE K163		53
EG287	SEE N322		122	F780	5KCP49UN9837S	✓	117	G183	SEE K1413		196	G345	SEE E2125		53
EG297	SEE N647A		123	F781	5KCP49UN9838S	✓	113	G184	SEE K520		196	G347	056T17F5302	✓	53
EG302	SEE N566		124	F1201	048C17F11005	✓	112	G185	SEE K549		196	G374A	056T17F15666	✓	53
EG303	SEE N567		124	F1202	048C17F11006	✓	112	G186	SEE K1416		196	G348	SEE G348A		53
EG304	SEE N622		124	F1203	048C17F11007	✓	112	G201	SEE K248A		46	G348A	056T17F15667	✓	53
EG305	SEE N569		124	F1204	056C17F15537	✓	112	G203	SEE K249A		46	G350	SEE C264		30
EG306	SEE N599		124	F1205	056B17F15516	✓	112	G205	056T34D5327		46	G352	056C34F5308	✓	30
EG307	SEE N623		124	FB1106TE	Century	✓	175	G205A	056T34D15594		46	G354	SEE C268		30
EG308	SEE N601		124	FB1156TE	Century	✓	175	G207	SEE K250A		46	G355	SEE C269		30
EG309	SEE N602A		124	FB3154	Century	✓	208	G209	SEE K220		46,140,201	G356	056C17F5308	✓	30
EG310	SEE N626A		124	FY1106V1	Century	✓	176	G212	SEE G212A		28	G357	SEE C271		30
EG311	SEE N627A		124	FY3106	Century	✓	180	G212A	056B17D11015	✓	28	G359	056C34F5310	✓	30
EG312	SEE N605		124	FY3156	Century	✓	180	G216	SEE C216A		28	G360	SEE G360A		53
EL2002V1	Century	✓	202	G044	SEE G044A		39	G216A	056B34D11018	✓	28	G360A	056T11F15525	✓	53
EL2005	Century	✓	202	G044A	048T17D11009	✓	39	G221	SEE K251A		46	G363	SEE G363A		53
EL2022	Century	✓	202	G046	SEE G046A		39	G223	SEE K222		46,140,201	G363A	056T34F15619		53
EL2034	Century	✓	202	G046A	056T17D11051		39	G225	SEE K521A		46	G365	SEE G365A		53
F10E1	5KCR49TN0063Y	✓	110	G047	SEE G047A		39	G227	SEE K224		46,140,201	G365A	056T17F15668	✓	53
F12E1	SEE F102		110	G047A	056T17D11049	✓	39	G229	SEE K644A		46	G368	SEE G368A		54

CAT. NO.	MODEL NO.	STOCK	PAGE NO.	CAT. NO.	MODEL NO.	STOCK	PAGE NO.	CAT. NO.	MODEL NO.	STOCK	PAGE NO.	CAT. NO.	MODEL NO.	STOCK	PAGE NO.
G368A	056T34F15623		54	G583	SEE G583A		60	G915A	056B34D11019	✓	24	GT0016A	213TTDBD6026	✓	49
G369	SEE G396A		54	G583A	056T17F15639	✓	60	G917	SEE C175A		24	GT0017	254TTDCAG6076	✓	49
G369A	056T17F15669	✓	54	G584	056T17F5324	✓	61	G918	SEE C176A		24	GT0018	213TTDB6001	✓	49
G371	SEE C275		30	G584A	056T17F15641	✓	61	G919	SEE G919A		24	GT0018A	213TTDBD6001	✓	49
G372	SEE C276		30	G585	SEE G585A		61	G919A	056B17DRR70011A1	✓	24	GT0019	215TTDB6026	✓	49
G373	056C17F5311	✓	30,224	G585A	056T17F15640	✓	61	G908A	056T17DRR70023A1	✓	39	GT0019A	215TTDBD6026	✓	49
G374	056B34F5320	✓	30	G586	056T11F5311	✓	60	G921	SEE G921A		39	GT0020	256TTDCAG6076	✓	49
G376	SEE G1376		30	G587	056T11F5310	✓	60	G921A	056T17DRR70010A1	✓	39	GT0021	215TTDB6001	✓	49
G377	SEE G1377		30	G588	056T11F5309	✓	60	G923	056T17D5344	✓	40	GT0021A	215TTDBD6001	✓	49
G378	056B17F5302	✓	30,224	G589	056T11F5308	✓	60	G923A	056T17DRR70011A1	✓	40	GT0022	254TTDCAG6026	✓	49
G379	056C34F5309	✓	30,224	G590	SEE G590A		61	G930	SEE C178A		24	GT0023	284TTDCAG6076	✓	49
G380	056C17F5957	✓	224	G590A	182TFW16045	✓	61	G932	SEE C179A		24	GT0024	254TTDCAG6001	✓	49
G381	056C17F5955	✓	224	G591	SEE G591A		61	G934	SEE C181A		24	GT0025	256TTDCAG6026	✓	49
G382	056C17F5956	✓	224	G591A	182TFW16047	✓	61	G935	SEE C182A		24	GT0026	286TTDCAG6076	✓	49
G383	SEE G383A		53	G639	056C17E5314	✓	37	G936	SEE C1480	216,223		GT0027	256TTDCAG6001	✓	49
G383A	056T34F15636		53	G639A	056C17E15513	✓	37	G937	SEE G937A		25	GT0028	284TTDCAG6026	✓	49
G385	SEE E2109		54	G646	056T17E5308	✓	84	G937A	056B34D11012	✓	25	GT0029	324TTDCAG6076	✓	49
G387	SEE E2110		54	G647	056T17E5309	✓	84	G939	SEE C185A		25	GT0030	284TTDCAG6001	✓	49
G390	056C34F5311	✓	30,224	G648	056T34G5303	✓	84	G950	SEE C186A		25	GT0031	286TTDCAG6026	✓	49
G391	056B34F5321	✓	30	G649	056T17G5312	✓	84	G951	056C17D5308	✓	216	GT0032	326TTDCAG6076	✓	49
G392	SEE G1392		31	G650	056C11G5306	✓	37	G952	SEE C187A		25	GT0033	286TTDCAG6001	✓	50
G393	056C34F5307	✓	30	G651	056C17G5315	✓	37	G958	056B17D5323	✓	223	GT0034	324TTDCAG6026	✓	50
G396	056B17F5310	✓	224	G651A	056C17G15555	✓	37	G961	056T17D2118	✓	196	GT0035	364TTDCB6086	✓	50
G502	SEE K253		58	G652	056C11G5307	✓	37	G962	056T17D2119	✓	196	GT0036	324TTDCAG6001	✓	50
G503	SEE K522		58	G653	056C34G5308	✓	37	G963	056T17D2120	✓	196	GT0037	326TTDCAG6026	✓	50
G507	SEE K254		58	G654	056C17G5316	✓	37	G964	056T17D2117	✓	196	GT0038	365TTDCB6086	✓	50
G508	SEE K469		58	G654A	056C17G15556	✓	37	G965	056T17D5357	✓	196	GT0039	326TTDCAG6001	✓	50
G511	SEE G1511		32	G655	056B11G5301	✓	37	G966	SEE K277		196	GT0040	364TTDCB6060	✓	50
G513	SEE G1513		32	G656	056C34G5309	✓	37	G967	056T17D5385	✓	196	GT0041	404TTDCB6086	✓	50
G514	056C34F5322	✓	32	G657	056C17G5317	✓	37	G976	056B34D5304	✓	223	GT0041A	404TTDCB6086	✓	50
G515	SEE G1515		32	G657A	056C17G15557	✓	37	G979	056B17D5319	✓	223	GT0042	364TTDCB6001	✓	50
G516	056C34F5323	✓	32	G658	056C34G5310	✓	37	G987	056B34D2021	✓	223	GT0043	365TTDCB6060	✓	50
G517	SEE G1517		32	G659	056C17G5318	✓	37	G996	056B34D5334	✓	223	GT0044	405TTDC16081	✓	51
G518	056C34F5324	✓	32	G659A	056C17G15558	✓	37	G1098	SEE G1098A		24	GT0044A	405TTDCD6081	✓	51
G519	SEE G1519		32	G660	056T34G5304	✓	84	G1098A	048B34D11003	✓	24	GT0045	365TTDCB6001	✓	51
G522	SEE K255		58	G661	056T17G5313	✓	84	G1114	5KC35JN7	✓	190	GT0046	404TTDCB6060	✓	51
G523	SEE K523		58	G662	SEE G662A		84	G1115	5KC35JN7X	✓	190	GT0046A	404TTDCD6060	✓	51
G527	SEE G527A		58	G662A	056T34G15577	✓	84	G1312	5KC32GN19	✓	30	GT0047	444TTDC16077	✓	51
G527A	056T17F15660	✓	58	G663	056T17G5314	✓	84	G1316	5KC49MN6061	✓	30	GT0047A	444TTDCD6077	✓	51
G528	SEE G528A		58	G663A	056T17G15600	✓	84	G1330	5KC35MN43	✓	30	GT0048	404TTDCD6001	✓	51
G528A	056T17F15901	✓	58	G664	056T17E5314	✓	84	G1331	5KC35MN43X	✓	30	GT0048A	404TTSTDCD6001	✓	51
G530	SEE C1424		32	G665	056T17E5315	✓	84	G1340	5K36PN251	✓	53	GT0049	405TTDCB6060	✓	51
G531	SEE G1531		32	G666	056T17G5321	✓	84	G1376	5KCR48WN0273	✓	30	GT0049A	405TTDCD6060	✓	51
G533	056B34F5319	✓	32	G667	056T17G5322	✓	84	G1377	5KCR48WN0273X	✓	30	GT0050	445TTDC16076	✓	51
G534	SEE C1419		32	G668	SEE G668A		84	G1392	5KCR49TN2139U	✓	31	GT0050A	445TTDCB6076	✓	51
G541	SEE G541A		58	G668A	056T17G15598	✓	84	G1511	5KC32GN25	✓	32	GT0051	405TTDCD6007	✓	51
G541A	056T17F15657	✓	58	G691	056B17G15522	✓	37	G1513	5KC35MN73	✓	32	GT0051A	405TTSTDCD6007	✓	51
G544	SEE G544A		59	G827	056T17E5310	✓	85	G1515	5KCA2GN0018	✓	32	GT0052	444TTDCB6060	✓	51
G544A	056T17F15665	✓	59	G828	056T17E5311	✓	85	G1517	5KCA46PN0032	✓	32	GT0052A	444TTDCD6060	✓	51
G547	SEE K252		58	G829	056T17G5315	✓	85	G1519	5KCA9TN0035	✓	32	GT0053	447TTDC16077	✓	51
G548	SEE G548A		58	G840	056T17G5316	✓	85	G1531	5KCR48WN0294	✓	32	GT0053A	447TTDCD6077	✓	51
G548A	056T17F15674		58	G841	SEE G841A		85	G1572	---		36	GT0054	444TTSTDC16003	✓	51
G549	SEE G549A		59	G841A	056T17G15599	✓	85	G1573	---		36	GT0054A	444TTSTDCD6003	✓	51
G549A	056T17F15903		59	G842	056T17E5312	✓	85	G1574	---		36	GT0055	445TTDCB6060	✓	51
G550	SEE C1405		34	G843	056T17E5313	✓	85	G1575	---		36	GT0055A	445TTDCD6060	✓	51
G551	SEE C375		34	G844	056T17G5318	✓	85	G1576	---		36	GT0056	449TTDC16076	✓	51
G552	SEE C1425		34	G845	056T17G5319	✓	85	GF2014	Century	✓	188	GT0056A	449TTDCD6076	✓	51
G553	SEE C376		34	G846	SEE G846A		85	GF2020L	Century	✓	188	GT0057	254TTDBD6076	✓	49
G559	SEE C1420		34	G846A	056T17G15615	✓	85	GF2024	Century	✓	188	GT0058	256TTDBD6076	✓	49
G560	SEE K1322		60	G852	056C17E5319	✓	38	GF2024D	Century	✓	188	GT0059	254TTDBD6026	✓	49
G561	SEE K1324		60	G853	056C17G5320	✓	38	GF2031L	Century	✓	188	GT0060	284TTDBD6076	✓	49
G562	SEE K258		60	G854	056C34G5311	✓	38	GF2034	Century	✓	188	GT0061	254TTDBD6001	✓	49
G563	SEE G563A		60	G855	056C17G5321	✓	38	GF2034D	Century	✓	188	GT0062	256TTDBD6026	✓	49
G563A	056T17F15658	✓	60	G857	056C17G5322	✓	38	GF2035	Century	✓	188	GT0063	286TTDBD6076	✓	49
G564	SEE G564A		61	G858	056C34G5316	✓	38	GF2038	Century	✓	188	GT0064	256TTDBD6001	✓	49
G564A	056T17F15664	✓	61	G870	056C17G5323	✓	38	GF2054	Century	✓	189	GT0065	284TTDBD6026	✓	49
G565	056T17F2051	✓	60	G871	056C17G5324	✓	38	GF2054D	Century	✓	189	GT0067	286TTDBD6026	✓	49
G569	056T34F5308	✓	60	G872	056C17G5328	✓	38	GK2054	Century	✓	189	GT0068	324TTDBD6076	✓	49
G570	056C17F5320	✓	36	G873	056C34G5314	✓	38	GK2074	Century	✓	189	GT0069	284TTSTDBD6001	✓	49
G571	056C17F5321	✓	36	G874	056C17G5326	✓	38	GK2104DV1	Century	✓	189	GT0071	326TTDBD6076	✓	49
G572	056C17F5322	✓	36	G875	056C34G5315	✓	38	GT0005	182TTDB6076	✓	48	GT0072	286TTSTDBD6001	✓	50
G573	056C17F5323	✓	36	G876	056C17G5327	✓	38	GT0008	184TTDB6076	✓	48	GT0073	324TTDBD6026	✓	50
G574	056B17F5305	✓	36	G905	SEE G905A		39	GT0010	182TTDB6026	✓	48	GT0075	364TTDBD6086	✓	50
G575	056B17F5306	✓	36	G905A	056T17DRR70021A1	✓	39	GT0011	213TTDB6076	✓	48	GT0076	324TTSTDBD6001	✓	50
G576	056C11F5303	✓	36	G908	SEE G908A		39	GT0011A	213TTDBD6076	✓	48	GT0077	326TTDBD6026	✓	50
G577	056C11F5302	✓	36	G908A	056T17DRR70023A1	✓	39	GT0012	182TTDB6001	✓	48	GT0079	365TTDBD6086	✓	50
G578	056B11F5303	✓	36	G910	SEE C167A		24	GT0013	184TTDB6026	✓	48	GT0080	326TTSTDBD6001	✓	50
G579	056B11F5302	✓	36	G911	SEE C168A		24	GT0014	215TTDB6076	✓	48	GT0081	364TTDBD6060	✓	50
G580	056T17F5305	✓	60	G912	SEE C169		216	GT0014A	215TTDBD6076	✓	48	GT0082	364TTSTDBD6060	✓	50
G581	056T17F5321	✓	60	G913	SEE C1263A		24	GT0015	184TTDB6001	✓	49	GT0083	364TTSTDBD6001	✓	50
G582	056T17F5322	✓	60	G915	SEE G915A		24	GT0016	213TTDBD6026	✓	49	GT0084	365TTDBD6060	✓	51

Index

Catalog Number/Model Number

INDEX

CAT. NO.	MODEL NO.	STOCK	PAGE NO.	CAT. NO.	MODEL NO.	STOCK	PAGE NO.	CAT. NO.	MODEL NO.	STOCK	PAGE NO.	CAT. NO.	MODEL NO.	STOCK	PAGE NO.
GT0085	365STDBD6060	✓	51	GT0515	184TTDB6008	✓	147	GT1025	256TTFCA6026	✓	65	GT1110A	182TTFC6030	✓	64
GT0086	365STDBD6001	✓	51	GT0516	213TTDB6033	✓	147	GT1025A	256TTFC6026	✓	65	GT1111	213TTFC6080	✓	64
GT0093	404STDC6060	✓	51	GT0516A	213TTDBD6033	✓	147	GT1026	286TTFCA6076	✓	65	GT1111A	213TTFC6080	✓	64
GT0093A	404STDC6060	✓	51	GT0517	254TTDCA6092	✓	147	GT1026A	286TTFC6076	✓	65	GT1112	184TTFC6005	✓	64
GT0094	365STDCB6060	✓	51	GT0518	213TTDB6008	✓	148	GT1027	284STFCA6001	✓	65	GT1112A	184TTFC6005	✓	64
GT0095	364STDCB6060	✓	51	GT0518A	213TTDBD6008	✓	148	GT1027A	284STFC6001	✓	65	GT1113	184TTFC6030	✓	64
GT0401	143TTDR6030	✓	146	GT0519	215TTDB6033	✓	148	GT1028	284TTFCA6026	✓	65	GT1113A	184TTFC6030	✓	64
GT0402	145TTDR16080	✓	146	GT0519A	215TTDBD6033	✓	148	GT1028A	284TTFC6026	✓	66	GT1114	215TTFC6080	✓	64
GT0403	143TTDR6007	✓	146	GT0520	256TTDCA6092	✓	148	GT1029	324TTFCA6076	✓	66	GT1114A	215TTFC6080	✓	64
GT0404	145TTDR6034	✓	146	GT0521	215TTDB6008	✓	148	GT1029A	324TTFC6076	✓	66	GT1115	213TTFC6005	✓	64
GT0405	182TTDB6082	✓	146	GT0521A	215TTDBD6008	✓	148	GT1030	286STFCA6001	✓	66	GT1115A	213TTFC6005	✓	64
GT0406	145TTDR6007	✓	146	GT0522	254TTDCA6033	✓	148	GT1030A	286STFC6001	✓	66	GT1116	213TTFC6030	✓	64
GT0407	145TTDR6036	✓	146	GT0523	284TTDCA6092	✓	148	GT1031	284TTFCA6026	✓	66	GT1116A	213TTFC6030	✓	64
GT0408	184TTDB6082	✓	146	GT0524	254TTDCA6008	✓	148	GT1031A	286TTFC6026	✓	66	GT1117	254TTFCA6080	✓	64
GT0409	145TTDR6013	✓	147	GT0525	256TTDCA6033	✓	149	GT1032	326TTFCA6076	✓	66	GT1117A	254TTFC6080	✓	64
GT0410	182TTDB6032	✓	147	GT0526	286TTDCA6092	✓	149	GT1032A	326TTFC6076	✓	66	GT1118	215TTFC6005	✓	64
GT0411	213TTDB6082	✓	147	GT0527	256TTDCA6008	✓	149	GT1033	324STFCA6001	✓	66	GT1118A	215TTFC6005	✓	64
GT0411A	213TTDBD6082	✓	147	GT0528	284TTDCA6033	✓	149	GT1033A	324STFC6001	✓	66	GT1119	215TTFC6030	✓	65
GT0412	182TTDB6007	✓	147	GT0529	324TTDCA6092	✓	149	GT1034	324TTFCA6026	✓	66	GT1119A	215TTFC6030	✓	65
GT0413	184TTDB6032	✓	147	GT0530	284TTDCA6008	✓	149	GT1034A	324TTFC6026	✓	66	GT1120	256TTFCA6080	✓	65
GT0414	215TTDB6082	✓	147	GT0531	286TTDCA6033	✓	149	GT1035	364TTFCA6086	✓	66	GT1120A	256TTFC6080	✓	65
GT0414A	215TTDBD6082	✓	147	GT0532	326TTDCA6092	✓	149	GT1035A	364TTFC6086	✓	66	GT1121	254TTFCA6005	✓	65
GT0415	184TTDB6007	✓	147	GT0533	286TTDCA6008	✓	149	GT1036	326STFCA6001	✓	66	GT1121A	254TTFC6005	✓	65
GT0416	213TTDB6032	✓	147	GT0534	324TTDCA6033	✓	149	GT1036A	326STFC6001	✓	66	GT1122	254TTFCA6030	✓	65
GT0416A	213TTDBD6032	✓	147	GT0536	324TTDCA6008	✓	149	GT1037	326TTFCA6026	✓	66	GT1122A	254TTFC6030	✓	65
GT0417	254TTDCA6082	✓	147	GT0537	326TTDCA6033	✓	149	GT1037A	326TTFC6026	✓	66	GT1123	284TTFCA6080	✓	65
GT0418	213TTDB6007	✓	148	GT0557	254TTDBD6092	✓	147	GT1038	365TTFCA6086	✓	67	GT1123A	284TTFC6080	✓	65
GT0418A	213TTDBD6007	✓	148	GT0558	256TTDBD6092	✓	148	GT1038A	365TTFC6086	✓	67	GT1124	256TTFCA6005	✓	65
GT0419	215TTDB6032	✓	148	GT0559	254TTDBD6033	✓	148	GT1039	364STFCA6001	✓	67	GT1124A	256TTFC6005	✓	65
GT0419A	215TTDBD6032	✓	148	GT0560	284TTDBD6092	✓	148	GT1039A	364STFC6001	✓	67	GT1125	256TTFCA6030	✓	65
GT0420	256TTDCA6082	✓	148	GT0561	254TTDBD6008	✓	148	GT1040	364TTFCA6036	✓	67	GT1125A	256TTFC6030	✓	65
GT0421	215TTDB6007	✓	148	GT0562	256TTDBD6033	✓	149	GT1040A	364TTFC6036	✓	67	GT1126	286TTFCA6080	✓	65
GT0421A	215TTDBD6007	✓	148	GT0563	286TTDBD6092	✓	149	GT1041	404TTFC6086	✓	67	GT1126A	286TTFC6080	✓	65
GT0422	254TTDCA6032	✓	148	GT0564	256TTDBD6008	✓	149	GT1041A	404TTFC6086	✓	67	GT1127	284STFCA6005	✓	65
GT0423	284TTDCA6082	✓	148	GT0565	284TTDBD6033	✓	149	GT1042	365STFCA6001	✓	67	GT1127A	284STFC6005	✓	65
GT0424	254TTDCA6007	✓	148	GT0567	286TTDBD6033	✓	149	GT1042A	365STFC6001	✓	67	GT1128	284TTFCA6030	✓	66
GT0425	256TTDCA6032	✓	149	GT0568	324TTDBD6092	✓	149	GT1043	365TTFCA6036	✓	67	GT1128A	284TTFC6030	✓	66
GT0426	286TTDCA6082	✓	149	GT0569	284TTDBD6008	✓	149	GT1043A	365TTFC6036	✓	67	GT1129	324TTFCA6080	✓	66
GT0427	256TTDCA6007	✓	149	GT0571	326TTDBD6092	✓	149	GT1044	405TTFC6086	✓	67	GT1129A	324TTFC6080	✓	66
GT0428	284TTDCA6032	✓	149	GT0572	286TTDBD6008	✓	149	GT1044A	405TTFC6086	✓	67	GT1130	286STFCA6005	✓	66
GT0429	324TTDCA6082	✓	149	GT0573	324TTDBD6033	✓	149	GT1045	405STFCA6001	✓	67	GT1130A	286STFC6005	✓	66
GT0430	284TTDCA6007	✓	149	GT0576	324TTDBD6008	✓	149	GT1045A	405STFC6001	✓	67	GT1131	286TTFCA6030	✓	66
GT0431	286TTDCA6032	✓	149	GT0577	326TTDBD6033	✓	149	GT1046	405TTFC6036	✓	67	GT1131A	286TTFC6030	✓	66
GT0432	326TTDCA6082	✓	149	GT1004	145TTFC6026	✓	63	GT1046A	405TTFC6036	✓	67	GT1132	326TTFCA6080	✓	66
GT0433	286TTDCA6007	✓	149	GT1005	182TTFC6076	✓	63	GT1047	444TTFC6086	✓	67	GT1132A	326TTFC6080	✓	66
GT0434	324TTDCA6032	✓	149	GT1005A	182TTFC6076	✓	63	GT1047A	444TTFC6086	✓	67	GT1133	324STFCA6005	✓	66
GT0436	324TTDCA6007	✓	149	GT1007	145TTFC6027	✓	63	GT1048	445TTFC6001	✓	68	GT1133A	324STFC6005	✓	66
GT0437	326TTDCA6032	✓	149	GT1008	184TTFC6076	✓	63	GT1048A	444TTFC6001	✓	68	GT1134	324TTFCA6030	✓	66
GT0457	254TTDBD6082	✓	147	GT1008A	184TTFC6076	✓	63	GT1049	444TTFC6036	✓	68	GT1134A	324TTFC6030	✓	66
GT0458	256TTDBD6082	✓	148	GT1009	182TTFC6001	✓	63	GT1049A	444TTFC6036	✓	68	GT1135	364TTFCA6080	✓	66
GT0459	254TTDBD6032	✓	148	GT1009A	182TTFC6001	✓	63	GT1050	445TTFC6086	✓	68	GT1135A	364TTFC6080	✓	66
GT0460	284TTDBD6082	✓	148	GT1010	182TTFC6026	✓	64	GT1050A	445TTFC6086	✓	68	GT1136	326STFCA6005	✓	66
GT0461	254TTDBD6007	✓	148	GT1010A	182TTFC6026	✓	64	GT1051	445TTFC6001	✓	68	GT1136A	326STFC6005	✓	66
GT0462	256TTDBD6032	✓	149	GT1011	213TTFC6076	✓	64	GT1051A	445STFCA6001	✓	68	GT1137	326TTFCA6030	✓	66
GT0463	286TTDBD6082	✓	149	GT1011A	213TTFC6076	✓	64	GT1052	445TTFC6036	✓	68	GT1137A	326TTFC6030	✓	67
GT0464	256TTDBD6007	✓	149	GT1012	184TTFC6001	✓	64	GT1052A	445TTFC6036	✓	68	GT1138	365TTFCA6080	✓	67
GT0465	284TTDBD6032	✓	149	GT1012A	184TTFC6001	✓	64	GT1053	447TTFC6087	✓	68	GT1138A	365TTFC6080	✓	67
GT0467	286TTDBD6032	✓	149	GT1013	184TTFC6026	✓	64	GT1053A	447TTFC6087	✓	68	GT1139	364STFCA6005	✓	67
GT0468	324TTDBD6082	✓	149	GT1013A	184TTFC6026	✓	64	GT1054	447STFCA6004	✓	68	GT1139A	364STFC6005	✓	67
GT0469	284TTDBD6007	✓	149	GT1014	215TTFC6076	✓	64	GT1054A	447STFC6004	✓	68	GT1140	364TTFCA6040	✓	67
GT0471	326TTDBD6082	✓	149	GT1014A	215TTFC6076	✓	64	GT1055	447TTFC6038	✓	68	GT1140A	364TTFC6040	✓	67
GT0472	286TTDBD6007	✓	149	GT1015	213TTFC6001	✓	64	GT1055A	447TTFC6038	✓	68	GT1141	404TTFC6080	✓	67
GT0473	324TTDBD6032	✓	149	GT1015A	213TTFC6001	✓	64	GT1056	449TTFC6088	✓	68	GT1141A	404TTFC6080	✓	67
GT0476	324TTDBD6007	✓	149	GT1016	213TTFC6026	✓	64	GT1056A	449TTFC6088	✓	68	GT1142	365STFCA6002	✓	67
GT0477	326TTDBD6032	✓	149	GT1016A	213TTFC6026	✓	64	GT1057	284STFCA6026	✓	66	GT1142A	365STFC6002	✓	67
GT0501	143TTDR6031	✓	146	GT1017	254TTFCA6076	✓	64	GT1058	286STFCA6026	✓	66	GT1143	365TTFCA6040	✓	67
GT0502	145TTDR16081	✓	146	GT1017A	254TTFC6076	✓	64	GT1059	324STFCA6026	✓	66	GT1143A	365TTFC6040	✓	67
GT0503	143TTDR6008	✓	146	GT1018	215TTFC6001	✓	64	GT1060	326STFCA6026	✓	66	GT1144	405TTFC6080	✓	67
GT0504	145TTDR6031	✓	146	GT1018A	215TTFC6001	✓	64	GT1061	364STFCA6036	✓	67	GT1144A	405TTFC6080	✓	67
GT0505	182TTDB6092	✓	146	GT1019	215TTFC6026	✓	65	GT1062	365STFCA6036	✓	67	GT1145	405STFCA6005	✓	67
GT0506	145TTDR6004	✓	146	GT1019A	215TTFC6026	✓	65	GT1063	405STFCA6036	✓	67	GT1145A	405STFC6005	✓	67
GT0507	145TTDR6030	✓	146	GT1020	256TTFCA6076	✓	65	GT1064	444STFCA6036	✓	68	GT1146	405TTFC6040	✓	67
GT0508	184TTDB6092	✓	146	GT1020A	256TTFC6076	✓	65	GT1065	445STFCA6036	✓	68	GT1146A	405TTFC6040	✓	67
GT0509	145TTDR6006	✓	147	GT1021	254TTFCA6001	✓	65	GT1066	447STFCA6038	✓	68	GT1147	444TTFC6080	✓	67
GT0510	182TTDB6033	✓	147	GT1021A	254TTFC6001	✓	65	GT1105	182TTFC6080	✓	63	GT1147A	444TTFC6080	✓	67
GT0511	213TTDB6092	✓	147	GT1022	254TTFCA6026	✓	65	GT1105A	182TTFC6080	✓	63	GT1148	444TTFC16002	✓	68
GT0511A	213TTDBD6092	✓	147	GT1022A	254TTFC6026	✓	65	GT1108	184TTFC6080	✓	63	GT1148A			

CAT. NO.	MODEL NO.	STOCK	PAGE NO.	CAT. NO.	MODEL NO.	STOCK	PAGE NO.	CAT. NO.	MODEL NO.	STOCK	PAGE NO.	CAT. NO.	MODEL NO.	STOCK	PAGE NO.
GT1151	445STFC6005	✓	68	GT1305	182TTFB6079	✓	69	GT2418	213TDB6012	✓	155	GT2557	254TTDBD6095	✓	155
GT1151A	445STFC6005	✓	68	GT1305A	182TTFB6079	✓	69	GT2418A	213TDBD6012	✓	155	GT2558	256TTDBD6095	✓	155
GT1152	445TFC6037	✓	68	GT1308	184TTFB6079	✓	69	GT2419	215TTDB6037	✓	156	GT2559	254TTDBD6038	✓	155
GT1152A	445TFC6037	✓	68	GT1308A	184TTFB6079	✓	69	GT2419A	215TTDBD6037	✓	156	GT2560	284TTDBD6095	✓	155
GT1153	447TFC6080	✓	68	GT1309	182TTFB6004	✓	69	GT2420	256TDC6085	✓	156	GT2561	254TTDBD6013	✓	155
GT1153A	447TFC6080	✓	68	GT1309A	182TTFB6004	✓	69	GT2421	215TTDB6012	✓	156	GT2562	256TTDBD6038	✓	155
GT1154	447STFC6005	✓	68	GT1310	182TTFB6029	✓	69	GT2421A	215TTDBD6012	✓	156	GT2563	286TTDBD6095	✓	155
GT1154A	447STFC6005	✓	68	GT1310A	182TTFB6029	✓	69	GT2422	254TDC6037	✓	156	GT2564	256TTDBD6013	✓	157
GT1155	447TFC6039	✓	68	GT1311	213TTFBA6079	✓	69	GT2423	284TDC6085	✓	156	GT2565	284TTDBD6038	✓	157
GT1155A	447TFC6039	✓	68	GT1311A	213TTFBA6079	✓	69	GT2424	254TDC6012	✓	156	GT2566	286TTDBD6038	✓	157
GT1156	449TFC6080	✓	68	GT1312	184TTFB6004	✓	69	GT2425	256TDC6037	✓	156	GT2568	324TTDBD6095	✓	157
GT1156A	449TFC6080	✓	68	GT1312A	184TTFB6004	✓	69	GT2426	286TDC6085	✓	156	GT2569	284TTDBD6013	✓	157
GT1201	143TFR6032	✓	70	GT1313	184TTFB6029	✓	69	GT2427	256TDC6012	✓	157	GT2571	326TTDBD6095	✓	157
GT1202	145TFR16079	✓	70	GT1313A	184TTFB6029	✓	69	GT2428	284TDC6037	✓	157	GT2572	286TTDBD6013	✓	157
GT1203	143TFR6010	✓	70	GT1314	215TTFBA6079	✓	69	GT2429	324TDC6085	✓	157	GT2573	324TTDBD6038	✓	157
GT1204	145TFR6058	✓	70	GT1314A	215TTFB6079	✓	69	GT2430	284TDC6012	✓	157	GT2576	324TTDBD6013	✓	157
GT1205	182TTFB6078	✓	70	GT1315	213TTFBA6004	✓	69	GT2431	286TDC6037	✓	157	GT2577	326TTDBD6038	✓	157
GT1205A	182TTFB6078	✓	70	GT1315A	213TTFB6004	✓	69	GT2432	326TDC6085	✓	157	GT3001	143TFR16047	✓	150
GT1206	145TFR6009	✓	70	GT1316	213TTFBA6029	✓	69	GT2433	286TDC6012	✓	157	GT3003	143TFR16007	✓	150
GT1207	145TFR6040	✓	70	GT1316A	213TTFB6029	✓	69	GT2434	324TDC6037	✓	157	GT3004	145TFR16059	✓	150
GT1208	184TFR6078	✓	70	GT1318	215TTFBA6004	✓	69	GT2436	324TDC6012	✓	157	GT3006	145TFR16010	✓	150
GT1208A	184TFR6078	✓	70	GT1318A	215TTFB6004	✓	69	GT2437	326TDC6037	✓	157	GT3007	145TFR16037	✓	151
GT1209	182TTFB6003	✓	70	GT1319	215TTFBA6029	✓	69	GT2457	254TTDBD6085	✓	155	GT3101	143TFR16032	✓	150
GT1209A	182TTFB6003	✓	70	GT1319A	215TTFB6029	✓	69	GT2458	256TTDBD6085	✓	156	GT3102	145TFR16083	✓	150
GT1210	182TFR6028	✓	70	GT1401	143TFR16039	✓	70	GT2459	254TTDBD6037	✓	156	GT3103	143TFR16010	✓	150
GT1211	213TTFBA6078	✓	70	GT1403	143TFR16003	✓	70	GT2460	284TTDBD6085	✓	156	GT3104	145TFR16036	✓	150
GT1211A	213TTFB6078	✓	70	GT1404	145TFR16046	✓	70	GT2461	254TTDBD6012	✓	156	GT3105	182TFR6082	✓	150
GT1212	184TFR6003	✓	70	GT1406	145TFR16005	✓	70	GT2462	256TTDBD6037	✓	156	GT3106	145TFR16013	✓	150
GT1212A	184TFR6003	✓	70	GT1407	145TFR16047	✓	70	GT2463	286TTDBD6085	✓	156	GT3107	145TFR16037	✓	151
GT1213	184TFR6028	✓	70	GT1409	182TFR6007	✓	70	GT2464	256TTDBD6012	✓	157	GT3108	184TFR6082	✓	151
GT1213A	184TFR6028	✓	70	GT1409A	182TFR6007	✓	70	GT2465	284TTDBD6037	✓	157	GT3109	182TFR6006	✓	151
GT1214	215TTFBA6078	✓	70	GT1410	182TFR6032	✓	70	GT2467	286TTDBD6037	✓	157	GT3110	182TFR6031	✓	151
GT1214A	215TTFB6078	✓	70	GT1410A	182TFR6032	✓	70	GT2468	324TTDBD6085	✓	157	GT3111	213TFR6082	✓	151
GT1215	213TTFBA6003	✓	71	GT1412	184TFR6007	✓	70	GT2469	284TTDBD6012	✓	157	GT3111A	213TFR6082	✓	151
GT1215A	213TTFB6003	✓	71	GT1412A	184TFR6007	✓	70	GT2471	326TTDBD6085	✓	157	GT3112	184TFR6006	✓	151
GT1216	213TTFBA6028	✓	71	GT1413	184TFR6032	✓	70	GT2472	286TTDBD6012	✓	157	GT3113	184TFR6031	✓	151
GT1216A	213TTFB6028	✓	71	GT1413A	184TFR6032	✓	70	GT2473	324TTDBD6037	✓	157	GT3114	215TFR6082	✓	151
GT1217	254TFC6078	✓	71	GT1415	213TTFBA6007	✓	71	GT2476	324TTDBD6012	✓	157	GT3114A	215TFR6082	✓	151
GT1217A	254TFC6078	✓	71	GT1415A	213TTFB6007	✓	71	GT2477	326TTDBD6037	✓	157	GT3115	213TFR6006	✓	151
GT1218	215TTFBA6003	✓	71	GT1416	213TTFBA6032	✓	71	GT2501	143TDR16040	✓	154	GT3115A	213TFR6006	✓	151
GT1218A	215TTFB6003	✓	71	GT1416A	213TTFB6032	✓	71	GT2502	145TDR16082	✓	154	GT3116	213TFR6031	✓	151
GT1219	215TTFBA6028	✓	71	GT1418	215TTFBA6007	✓	71	GT2503	143TDR16006	✓	154	GT3116A	213TFR6031	✓	151
GT1219A	215TTFB6028	✓	71	GT1418A	215TTFB6007	✓	71	GT2504	145TDR16327	✓	154	GT3117	254TFC6082	✓	151
GT1220	256TFC6078	✓	71	GT1419	215TTFBA6032	✓	71	GT2505	182TTDB6095	✓	154	GT3117A	254TFC6082	✓	151
GT1220A	256TFC6078	✓	71	GT1419A	215TTFB6032	✓	71	GT2506	145TDR16017	✓	154	GT3118	215TFR6006	✓	151
GT1221	254TFC6003	✓	71	GT1421	254TFC6007	✓	71	GT2507	145TDR16339	✓	154	GT3118A	215TFR6006	✓	151
GT1221A	254TFC6003	✓	71	GT1421A	254TFC6007	✓	71	GT2508	184TTDB6095	✓	154	GT3119	215TFR6031	✓	152
GT1222	254TFC6028	✓	71	GT1422	254TFC6032	✓	71	GT2509	145TDR16303	✓	154	GT3119A	215TFR6031	✓	152
GT1222A	254TFC6028	✓	71	GT1422A	254TFC6032	✓	71	GT2510	182TTDB6038	✓	155	GT3120	256TFC6082	✓	152
GT1224	256TFC6003	✓	71	GT2001	143TDR16043	✓	146	GT2511	213TTDB6095	✓	155	GT3120A	256TFC6082	✓	152
GT1224A	256TFC6003	✓	71	GT2003	143TDR16009	✓	146	GT2511A	213TTDBD6095	✓	155	GT3121	254TFC6006	✓	152
GT1225	256TFC6028	✓	71	GT2004	145TDR16074	✓	146	GT2512	182TTDB6013	✓	155	GT3121A	254TFC6006	✓	152
GT1225A	256TFC6028	✓	71	GT2006	145TDR16015	✓	146	GT2513	184TTDB6038	✓	155	GT3122	254TFC6031	✓	152
GT1227	284STFC6003	✓	71	GT2007	145TDR16335	✓	146	GT2514	215TTDB6095	✓	155	GT3122A	254TFC6031	✓	152
GT1227A	284STFC6003	✓	71	GT2009	145TDR16023	✓	147	GT2514A	215TTDBD6095	✓	155	GT3123	284TFC6082	✓	152
GT1228	284TFC6028	✓	71	GT2301	143TDR16044	✓	154	GT2515	184TTDB6013	✓	155	GT3123A	284TFC6082	✓	152
GT1228A	284TFC6028	✓	71	GT2303	143TDR16010	✓	154	GT2516	213TTDBD6038	✓	155	GT3124	256TFC6006	✓	152
GT1230	286STFC6003	✓	72	GT2304	145TDR16075	✓	154	GT2516A	213TTDBD6038	✓	155	GT3124A	256TFC6006	✓	152
GT1230A	286STFC6003	✓	72	GT2306	145TDR16014	✓	154	GT2517	254TDC6095	✓	155	GT3125	256TFC6031	✓	152
GT1231	286TFC6028	✓	72	GT2307	145TDR16337	✓	154	GT2518	213TTDB6013	✓	155	GT3125A	256TFC6031	✓	152
GT1231A	286TFC6028	✓	72	GT2309	145TDR16024	✓	154	GT2518A	213TTDBD6013	✓	155	GT3126	286TFC6082	✓	152
GT1233	324STFC6003	✓	72	GT2401	143TDR16048	✓	154	GT2519	215TTDB6038	✓	156	GT3126A	286TFC6082	✓	152
GT1233A	324STFC6003	✓	72	GT2402	145TDR16079	✓	154	GT2519A	215TTDBD6038	✓	156	GT3127	284TFC6006	✓	152
GT1234	324TFC6028	✓	72	GT2403	143TDR16015	✓	154	GT2520	256TDC6095	✓	156	GT3127A	284TFC6006	✓	152
GT1234A	324TFC6028	✓	72	GT2404	145TDR16330	✓	154	GT2521	215TTDB6013	✓	156	GT3128	284TFC6032	✓	152
GT1236	326STFC6003	✓	72	GT2405	182TTDB6085	✓	154	GT2521A	215TTDBD6013	✓	156	GT3128A	284TFC6032	✓	152
GT1236A	326STFC6003	✓	72	GT2406	145TDR16020	✓	154	GT2522	254TDC6038	✓	156	GT3129	324TFC6082	✓	152
GT1237	326TFC6028	✓	72	GT2407	145TDR16333	✓	154	GT2523	284TDC6095	✓	156	GT3129A	324TFC6082	✓	152
GT1237A	326TFC6028	✓	72	GT2408	184TTDB6085	✓	154	GT2524	254TDC6013	✓	156	GT3130	286TFC6006	✓	153
GT1239	364STFC6003	✓	72	GT2409	145TDR16301	✓	154	GT2525	256TDC6038	✓	156	GT3130A	286TFC6006	✓	153
GT1239A	364STFC6003	✓	72	GT2410	182TTDB6037	✓	155	GT2526	286TDC6095	✓	156	GT3131	286TFC6032	✓	153
GT1240	364TFC6038	✓	72	GT2411	213TTDB6085	✓	155	GT2527	256TDC6013	✓	157	GT3131A	286TFC6032	✓	153
GT1240A	364TFC6038	✓	72	GT2411A	213TTDBD6085	✓	155	GT2528	284TDC6038	✓	157	GT3132	326TFC6082	✓	153
GT1242	365STFC6003	✓	72	GT2412	182TTDB6012	✓	155	GT2529	324TDC6095	✓	157	GT3132A	326TFC6082	✓	153
GT1242A	365STFC6003	✓	72	GT2413	184TTDB6037	✓	155	GT2530	284TDC6013	✓	157	GT3133	324TFC6007	✓	153
GT1243	365TFC6038	✓	72	GT2414	215TTDB6085	✓	155	GT2531	286TDC6038	✓	157	GT3133A	324TFC6007	✓	153
GT1243A	365TFC6038	✓	72	GT2414A	215TTDBD6085	✓	155	GT25							

Index

Catalog Number/Model Number

INDEX

CAT. NO.	MODEL NO.	STOCK	PAGE NO.	CAT. NO.	MODEL NO.	STOCK	PAGE NO.	CAT. NO.	MODEL NO.	STOCK	PAGE NO.	CAT. NO.	MODEL NO.	STOCK	PAGE NO.
GT3137A	326TFFCD6031	✓	153	GT3414A	215TFFBD6085	✓	159	GT3525	256TFFCA6038	✓	160	GT5403	143TFR16012	✓	158
GT3201	143TFR16046	✓	150	GT3415	213TFFB6012	✓	159	GT3525A	256TFFCD6038	✓	160	GT5404	145TFR16075	✓	158
GT3202	145TFR16085	✓	150	GT3415A	213TFFBD6012	✓	159	GT3526	286TFFCA6095	✓	160	GT5406	145TFR16015	✓	158
GT3203	143TFR16013	✓	150	GT3416	213TFFB6037	✓	159	GT3526A	286TFFCD6095	✓	160	GT5407	145TFR16055	✓	159
GT3204	145TFR16063	✓	150	GT3416A	213TFFBD6037	✓	159	GT3527	284TFFCA6013	✓	160	GT5501	143TFR16045	✓	158
GT3205	182TFFB6092	✓	150	GT3417	254TFFCA6085	✓	159	GT3527A	284TFFCD6013	✓	160	GT5503	143TFR16014	✓	158
GT3206	145TFR16018	✓	150	GT3417A	254TFFCD6085	✓	159	GT3528	284TFFCA6038	✓	160	GT5504	145TFR16065	✓	158
GT3207	145TFR16071	✓	151	GT3418	215TFFB6012	✓	159	GT3528A	284TFFCD6038	✓	160	GT5506	145TFR16019	✓	158
GT3208	184TFFB6092	✓	151	GT3418A	215TFFBD6012	✓	159	GT3529	324TFFCA6095	✓	160	GT5507	145TFR16073	✓	159
GT3209	182TFFB6008	✓	151	GT3419	215TFFB6037	✓	159	GT3529A	324TFFCD6095	✓	160	H041	Century	✓	170
GT3210	182TFFB6033	✓	151	GT3419A	215TFFBD6037	✓	159	GT3530	286TFFCA6013	✓	160	H042	Century	✓	170
GT3211	213TFFB6092	✓	151	GT3420	256TFFCA6085	✓	159	GT3530A	286TFFCD6013	✓	160	H112	5KH37PN39	✓	185
GT3211A	213TFFBD6092	✓	151	GT3420A	256TFFCD6085	✓	159	GT3531	286TFFCA6038	✓	160	H113-(GE)	SEE HG113	✓	185
GT3212	184TFFB6008	✓	151	GT3421	254TFFCA6012	✓	160	GT3531A	286TFFCD6038	✓	160	H114	5KH35FN124	✓	186
GT3213	184TFFB6033	✓	151	GT3421A	254TFFCD6012	✓	160	GT3532	326TFFCA6095	✓	160	H115-(GE)	SEE HG115	✓	186
GT3214	215TFFB6092	✓	151	GT3422	254TFFCA6037	✓	160	GT3532A	326TFFCD6095	✓	160	H116	5KH32FN66	✓	30
GT3214A	215TFFBD6092	✓	151	GT3422A	254TFFCD6037	✓	160	GT3533	324TFFCA6013	✓	160	H120-(GE)	SEE HG120	✓	30
GT3215	213TFFB6008	✓	151	GT3423	284TFFCA6085	✓	160	GT3533A	324TFFCD6013	✓	160	H121	SEE U759	✓	40
GT3215A	213TFFBD6008	✓	151	GT3423A	284TFFCD6085	✓	160	GT3534	324TFFCA6038	✓	160	H121-(GE)	SEE HG121	✓	30
GT3216	213TFFB6033	✓	151	GT3424	256TFFCA6012	✓	160	GT3534A	324TFFCD6038	✓	160	H123-(GE)	SEE HG123	✓	30
GT3216A	213TFFBD6033	✓	151	GT3424A	256TFFCD6012	✓	160	GT3536	326TFFCA6013	✓	160	H124-(GE)	SEE HG124	✓	30
GT3217	254TFFCA6092	✓	151	GT3425	256TFFCA6037	✓	160	GT3536A	326TFFCD6013	✓	160	H130	5KH39QN9632	✓	187
GT3217A	254TFFCD6092	✓	151	GT3425A	256TFFCD6037	✓	160	GT3537	326TFFCA6038	✓	160	H131	5KH39QN9631T	✓	187
GT3218	215TFFB6008	✓	151	GT3426	286TFFCA6085	✓	160	GT3537A	326TFFCD6038	✓	160	H133	5KH39QN9642T	✓	187
GT3218A	215TFFBD6008	✓	151	GT3426A	286TFFCD6085	✓	160	GT4001	143TDR16042	✓	146	H134	5KH32FN3122	✓	115
GT3219	215TFFB6033	✓	152	GT3427	284TFFCA6012	✓	160	GT4003	143TDR16012	✓	146	H135	5KH32FN3122S	✓	115
GT3219A	215TFFBD6033	✓	152	GT3427A	284TFFCD6012	✓	160	GT4004	145TDR16073	✓	146	H136	5KH49MN6057	✓	115
GT3220	256TFFCA6092	✓	152	GT3428	284TFFCA6037	✓	160	GT4006	145TDR16013	✓	146	H137	5KH49MN6057S	✓	115
GT3220A	256TFFCD6092	✓	152	GT3428A	284TFFCD6037	✓	160	GT4007	145TDR16336	✓	146	H138-(GE)	SEE HG138	✓	115
GT3221	254TFFCA6008	✓	152	GT3429	324TFFCA6085	✓	160	GT4009	145TDR16022	✓	147	H139	5KH33JN3121S	✓	115
GT3221A	254TFFCD6008	✓	152	GT3429A	324TFFCD6085	✓	160	GT4101	143TDR16047	✓	146	H140-(GE)	SEE HG140	✓	115
GT3222	254TFFCA6033	✓	152	GT3430	286TFFCA6012	✓	160	GT4103	143TDR16013	✓	146	H141-(GE)	SEE HG141	✓	115
GT3222A	254TFFCD6033	✓	152	GT3430A	286TFFCD6012	✓	160	GT4104	145TDR16329	✓	146	H142-(GE)	SEE HG142	✓	115
GT3223	284TFFCA6092	✓	152	GT3431	286TFFCA6037	✓	160	GT4106	145TDR16019	✓	146	H143-(GE)	SEE HG143	✓	115
GT3223A	284TFFCD6092	✓	152	GT3431A	286TFFCD6037	✓	160	GT4107	145TDR16332	✓	146	H150	143TDR5376	✓	39
GT3224	256TFFCA6008	✓	152	GT3432	326TFFCA6085	✓	160	GT4109	145TDR16305	✓	147	H152-(GE)	SEE HG152	✓	185
GT3224A	256TFFCD6008	✓	152	GT3432A	326TFFCD6085	✓	160	GT4201	143TDR16039	✓	146	H154-(GE)	SEE HG154	✓	185
GT3225	256TFFCA6033	✓	152	GT3433	324TFFCA6012	✓	160	GT4203	143TDR16007	✓	146	H155	Century	✓	142
GT3225A	256TFFCD6033	✓	152	GT3433A	324TFFCD6012	✓	160	GT4204	143TDR16046	✓	146	H155-(GE)	SEE HG155	✓	185
GT3226	286TFFCA6092	✓	152	GT3434	324TFFCA6037	✓	160	GT4206	145TDR16018	✓	146	H156-(GE)	SEE HG156	✓	185
GT3226A	286TFFCD6092	✓	152	GT3434A	324TFFCD6037	✓	160	GT4207	145TDR16338	✓	146	H157	5KH32DN3085X	✓	185
GT3227	284TFFCA6008	✓	152	GT3436	326TFFCA6012	✓	160	GT4209	145TDR16302	✓	147	H158	5KH37PN41	✓	185
GT3227A	284TFFCD6008	✓	152	GT3436A	326TFFCD6012	✓	160	GT4301	143TDR16045	✓	154	H159	5KH37PN41X	✓	185
GT3228	284TFFCA6033	✓	152	GT3437	326TFFCA6037	✓	160	GT4303	143TDR16011	✓	154	H160	5KH32FN3083	✓	185
GT3228A	284TFFCD6033	✓	152	GT3437A	326TFFCD6037	✓	160	GT4304	145TDR16326	✓	154	H161-(GE)	SEE HG161	✓	185
GT3229	324TFFCA6092	✓	152	GT3501	143TFR16044	✓	158	GT4306	145TDR16307	✓	154	H162	5KH46MN6053	✓	186
GT3229A	324TFFCD6092	✓	152	GT3502	145TFR16086	✓	158	GT4307	145TDR16342	✓	154	H163	5KH46MN6053X	✓	186
GT3230	286TFFCA6008	✓	153	GT3503	143TFR16015	✓	158	GT4309	145TDR16025	✓	154	H164	5KH32JN3128	✓	186
GT3230A	286TFFCD6008	✓	153	GT3504	145TFR16064	✓	158	GT4401	143TDR16049	✓	154	H165	5KH32JN3128X	✓	186
GT3231	286TFFCA6033	✓	153	GT3505	182TFFB6095	✓	158	GT4403	143TDR16014	✓	154	H166	5KH35JN26	✓	186
GT3231A	286TFFCD6033	✓	153	GT3506	145TFR16021	✓	158	GT4404	145TDR16331	✓	154	H167	5KH35JN26X	✓	186
GT3232	326TFFCA6092	✓	153	GT3507	145TFR16072	✓	159	GT4406	145TDR16021	✓	154	H168	5KH49PN6055	✓	186
GT3232A	326TFFCD6092	✓	153	GT3508	184TFFB6095	✓	159	GT4407	145TDR16334	✓	154	H169	5KH36KN114	✓	185
GT3233	324TFFCA6008	✓	153	GT3509	182TFFB6013	✓	159	GT4409	145TDR16306	✓	154	H170	5KH36KN114X	✓	185
GT3233A	324TFFCD6008	✓	153	GT3510	182TFFB6038	✓	159	GT4501	143TDR16041	✓	154	H171	5KH37PN33	✓	185
GT3234	324TFFCA6033	✓	153	GT3511	213TFFB6095	✓	159	GT4503	143TDR16008	✓	154	H172	5KH37PN33X	✓	185
GT3234A	324TFFCD6033	✓	153	GT3511A	213TFFBD6095	✓	159	GT4504	145TDR16328	✓	154	H173	5KH46MN3025	✓	186
GT3236	326TFFCA6008	✓	153	GT3512	184TFFB6013	✓	159	GT4506	145TDR16016	✓	154	H174	5KH46MN3025X	✓	186
GT3236A	326TFFCD6008	✓	153	GT3513	184TFFB6038	✓	159	GT4507	145TDR16340	✓	154	H175	5KH49PN3026	✓	187
GT3237	326TFFCA6033	✓	153	GT3514	215TFFB6095	✓	159	GT4509	145TDR16304	✓	154	H176	5KH49PN3026X	✓	187
GT3237A	326TFFCD6033	✓	153	GT3514A	215TFFBD6095	✓	159	GT5001	143TFR16048	✓	150	H178	447TSDN7001	✓	163
GT3301	143TFR16049	✓	158	GT3515	213TFFB6013	✓	159	GT5003	143TFR16005	✓	150	H178-(GE)	SEE HG178	✓	195
GT3303	143TFR16009	✓	158	GT3515A	213TFFBD6013	✓	159	GT5004	145TFR16058	✓	150	H180	143TDR5401	✓	39
GT3304	145TFR16060	✓	158	GT3516	213TFFB6038	✓	159	GT5006	145TFR16009	✓	150	H181	145TDR5401	✓	39
GT3306	145TFR16016	✓	158	GT3516A	213TFFBD6038	✓	159	GT5007	145TFR16066	✓	151	H181LES	Century	✓	44
GT3307	145TFR16068	✓	159	GT3517	254TFFCA6095	✓	159	GT5101	143TFR16052	✓	150	H181-(GE)	SEE B1502	✓	195
GT3401	143TFR16051	✓	158	GT3517A	254TFFCD6095	✓	159	GT5103	143TFR16006	✓	150	H182A	182TDDW7101	✓	40
GT3402	145TFR16084	✓	158	GT3518	215TFFB6013	✓	159	GT5104	145TFR16074	✓	150	H182-(GE)	SEE HG182	✓	195
GT3403	143TFR16011	✓	158	GT3518A	215TFFBD6013	✓	159	GT5106	145TFR16012	✓	150	H183A	184TDDW7101	✓	40
GT3404	145TFR16326	✓	158	GT3519	215TFFB6038	✓	159	GT5107	145TFR16057	✓	151	H184A	SEE H184B	✓	40
GT3405	182TFFB6085	✓	158	GT3519A	215TFFBD6038	✓	159	GT5201	143TFR16042	✓	150	H184B	213TDR16101	✓	40
GT3406	145TFR16014	✓	158	GT3520	256TFFCA6095	✓	159	GT5203	143TFR16004	✓	150	H185A	SEE H185B	✓	41
GT3407	145TFR16056	✓	159	GT3520A	256TFFCD6095	✓	159	GT5204	145TFR16062	✓	150	H185B	215TDR16101	✓	41
GT3408	184TFFB6085	✓	159	GT3521	254TFFCA6013	✓	160	GT5206	145TFR16017	✓	150	H185-(GE)	SEE B1504	✓	195
GT3409	182TFFB6012	✓	159	GT3521A	254TFFCD6013	✓	160	GT5207	145TFR16070	✓	151	H186A	SEE H186B	✓	41
GT3410	182TFFB6037	✓	159	GT3522	254TFFCA6038	✓	160	GT5301	143TFR16050	✓	158	H186B	254TDR16101	✓	41
GT3411	213TFFB6085	✓	159	GT3522A	254TFFCD6038	✓	160	GT5303	1						

CAT. NO.	MODEL NO.	STOCK	PAGE NO.	CAT. NO.	MODEL NO.	STOCK	PAGE NO.	CAT. NO.	MODEL NO.	STOCK	PAGE NO.	CAT. NO.	MODEL NO.	STOCK	PAGE NO.
H188B	284TTDN16101		42	H455-(GE)	SEE HG455		37	H694-(GE)	SEE HG694		187	H919	5KH36MNA735X		187
H188-(GE)	SEE HG188		195	H456-(GE)	SEE HG456		37	H695-(GE)	SEE HG695		185	H926	5KH36MNB837X		136
H189A	SEE H189B		42	H457	143TTFN8076	✓	53	H696	5KH36LNA504	✓	27	H941L	Century	✓	197
H189B	286TTDN16102		42	H458-(GE)	SEE HG458		37	H696	Century	✓	180	H942L	Century	✓	197
H189-(GE)	SEE HG189		195	H467ES	Century	✓	44	H697	Century	✓	180	H943V1	Century	✓	197
H190	5KH49MN3035	✓	195	H490	SEE K067A		39	H697-(GE)	SEE X1903		115	H950	Century	✓	197
H191A	SEE H191B		42	H502	SEE E591		88	H698	Century	✓	180	H951V1	Century	✓	44
H191B	326TDR16101		42	H503	SEE E596		88	H698-(GE)	SEE X1904		115	H952	145TDR5647		225
H191-(GE)	SEE HG191		195	H504	SEE H504A		88	H699-(GE)	SEE HG699		115	H952	Century	✓	197
H193	447TSDN7003	✓	163	H504A	449TTGS16557	✓	88	H699	Century	✓	180	H953	182TDR8353	✓	225
H193V1	Century	✓	142	H506	Century	✓	142	H700	143TFR5376	✓	53	H953V1	Century	✓	44
H195	5KH32GN42	✓	115	H513	SEE E595A		88	H700-(GE)	SEE HG700		186	H954	184TDR9040	✓	225
H196-(GE)	SEE HG196		115	H515	Century	✓	142	H701-(GE)	SEE HG701		185	H954	Century	✓	197
H197	5KH35MN132	✓	115	H526ES	Century	✓	44	H703-(GE)	SEE HG703		187	H955	213TTDW7053		225
H198	5KH35MN132S	✓	115	H534LES	Century	✓	44	H704-(GE)	SEE HG704		185	H955L	Century	✓	44
H203	5KH36PN106	✓	115	H536L	Century	✓	197	H705-(GE)	SEE HG705		186	H956	215TTDW7053	✓	225
H204	5KH32GN142	✓	199	H539L	Century	✓	44	H706ES	Century	✓	142	H956	Century	✓	45
H204ES	Century	✓	44	H564	Century	✓	180	H706-(GE)	SEE HG706		186	H957	254TTDX8338		225
H205	5KH37PN37	✓	199	H567	Century	✓	180	H707ES	Century	✓	142	H957L	Century	✓	197
H206	5KH36KN112	✓	199	H580	SEE E595A		88	H710-(GE)	SEE HG710		187	H962	Century	✓	180
H207	5KH46MN3041	✓	199	H581	SEE E591		88	H711-(GE)	SEE HG711		186	H963	Century	✓	180
H208	5KH32DN111	✓	199	H581V2	Century	✓	197	H712	5KH32GNB815X	✓	136	H964	Century	✓	175
H209	5KH37PN36	✓	199	H581AES	Century	✓	44	H714-(GE)	SEE HG714		136	H965V1ES	Century	✓	44
H210	5KH37PN36X	✓	199	H582V2	Century	✓	197	H715-(GE)	SEE HG715		187	H977	Century	✓	180
H212	5KH33FN77	✓	199	H601	SEE E901A		39	H716-(GE)	SEE HG716		204	H978V1	Century	✓	208
H213	5KH33FN77X	✓	199	H602ES	Century	✓	44	H717-(GE)	SEE HG717		204	H979L	Century	✓	208
H214	5KH46MN6071	✓	199	H604	SEE E902		40	H733	Century	✓	142	H980L	Century	✓	208
H215	5KH46MN6071X	✓	199	H607-(ME)	SEE E903		40	H734	Century	✓	142	H991LES	Century	✓	44
H217	5KH35JN121	✓	199	H607	Century	✓	142	H736ES	Century	✓	142	H992LES	Century	✓	44
H218	5KH35JN121X	✓	199	H609ES	Century	✓	142	H757	Century	✓	44	H993LES	Century	✓	44
H219	5KH49PN6069	✓	199	H612ES	Century	✓	142	H767V1	Century	✓	180	H1026	Century	✓	198
H221	5KH48UN6074	✓	199	H613	SEE E905B		41	H768	Century	✓	175	H1028	SEE H1028V1		198
H222	5KH49PN3047	✓	199	H614LES	Century	✓	44	H803	056T17D5398	✓	41	H1028V1	Century	✓	198
H223	5KH37PN40	✓	199	H615V2	Century	✓	197	H804	SEE X920		213	H1029	Century	✓	198
H224	5KH49SN3049	✓	199	H615	SEE E937A		41	H805	SEE X921		213	H1030L	Century	✓	198
H225	5KH46MN3040	✓	199	H616	SEE E906B		41	H806	SEE X922		213	H1031L	Century	✓	198
H226	5KH49PN3042	✓	199	H619	SEE E907A		41	H812	447TSDN7026	✓	163	H1039L	Century	✓	197
H229	5KH35HN9	✓	27	H620	5KH49PN3043	✓	185	H813	447TSDN7027	✓	163	H1045LES	Century	✓	44
H230	5KH39QN9091	✓	27	H621	SEE E788		42	H814	447TSDN7028	✓	163	H1050AV1	Century	✓	180
H233	5KH36PN109	✓	195	H621-(GE)	SEE HG621		186	H815	SEE H815A		163	H1050RBV1	Century	✓	180
H234	5KH39QN9105X	✓	195	H622	SEE E908A		42	H815A	449TSDN14033	✓	163	H1051A	Century	✓	180
H236	5KH35MNS56X	✓	195	H623	SEE U646A		55	H816	449TSDN7027	✓	163	H1051RB	Century	✓	180
H239	5KH33FN6	✓	24	H625	SEE E909A		42	H817	447TSDN7005	✓	163	H1052AV1	Century	✓	180
H243	5KH32GN68X	✓	30	H627	SEE E786A		42	H818	449TSDN7001	✓	163	H1052RBV1	Century	✓	180
H244	5KH32EN124	✓	32	H628	SEE E910A		42	H819	SEE H819A		163	H1053AV1	Century	✓	180
H247	5KH42JN0328S	✓	115	H631	SEE U901A		42	H819A	449TSDN14005	✓	163	H1053RB	Century	✓	180
H248	5KH36MN3106X	✓	187	H632	SEE E911		42	H820	SEE U790		43	H1054AV1	Century	✓	180
H262LES	Century	✓	44	H636	SEE E787A		42	H821A	SEE H821B		43	H1054RBV1	Century	✓	180
H262V2	Century	✓	197	H645	5KH39QN8810	✓	186	H821B	508UTDS16077		43	H1055A	Century	✓	180
H264A	Century	✓	197	H646-(GE)	SEE HG646		112	H822A	SEE H822B		43	H1056A	Century	✓	180
H267ES	Century	✓	44	H647	5KHC39QN9584X	✓	115	H822B	447TSDN16382		43	H1613	SEE E905B		41
H273LES	Century	✓	44	H648-(GE)	SEE HG648		115	H843V1	Century	✓	197	H1668	SEE E2163		54
H274	SEE U651		56	H649	5KHC39QN9575T	✓	115	H844	Century	✓	197	HG113	5KH37PN39X	✓	185
H275	5KH49PN3045	✓	187	H664	SEE E2151		53	H845	Century	✓	197	HG115	5KH35FN124X	✓	186
H275V2	Century	✓	197	H665	SEE E2154		53	H847	Century	✓	45	HG120	5KH32FN3123	✓	30
H276	5KH42JN0328	✓	115	H666	SEE E2157		54	H850L	Century	✓	197	HG121	5KH32FN3123X	✓	30
H277	5KH33KN20S	✓	115	H667V1	Century	✓	180	H851V2	Century	✓	197	HG123	5KH33FN85	✓	30
H278	5KH37PN37X	✓	199	H668	SEE E2163		54	H852L	Century	✓	197	HG124	5KH33FN85X	✓	30
H279ES	Century	✓	44	H669	SEE U627A		55	H853V2	Century	✓	197	HG138	5KH33JN3121	✓	115
H280	5KH49UN3024X	✓	199	H699	Century	✓	180	H854L	Century	✓	197	HG140	5KH36NN37	✓	115
H282	5KH49PN3042X	✓	199	H670	SEE E822A		55	H855L	Century	✓	197	HG141	5KH36NN37S	✓	115
H286	5KH36MN3106	✓	187	H671	Century	✓	180	H880LES	Century	✓	44	HG142	5KH49PN6056	✓	115
H287	5KH36KN112X	✓	199	H673	5KH33KN5594	✓	186	H881ES	Century	✓	44	HG143	5KH42GN0337	✓	115
H288	5KH49SN3023X	✓	199	H674	5KH35JNA231	✓	186	H882LES	Century	✓	44	HG152	5KH32GN140X	✓	185
H290	5KH36MN137	✓	199	H675	5KH33FNA230	✓	185	H883L	Century	✓	44	HG154	5KH36KN113X	✓	185
H291	5KH32EN72X	✓	195	H676	5KH35GNA229	✓	27	H884LES	Century	✓	44	HG155	5KH46MN3021X	✓	185
H293	5KH46PN3034	✓	195	H679	SEE E1799		40	H885L	Century	✓	44	HG156	5KH32DN3085	✓	185
H296	5KH49SN3046	✓	186	H679-(GE)	SEE HG679		136	H886L	Century	✓	44	HG161	5KH32FN3083X	✓	185
H298	5KH48UN6054X	✓	187	H680-(GE)	SEE HG680		136	H887L	Century	✓	44	HG178	5KH32EN79	✓	195
H300	5KH49SN3048	✓	186	H681-(GE)	SEE HG681		136	H891	5KC49LN6386	✓	37	HG182	5KH49MN6060	✓	195
H344	5KH36KNB833X	✓	136	H682	5KH32ENA443X	✓	136	H901	5KH32DNA612	✓	25	HG186	5KH46PN6059	✓	195
H350	143TTGN7076	✓	86	H683	5KH33GNA444X	✓	136	H902	5KH32DNA612X	✓	25	HG188	5KH49UN6064	✓	195
H377ES	Century	✓	44	H684	5KH36MNA445X	✓	136	H903	5KH32FNA611	✓	25	HG189	5KH36PN108	✓	195
H437ES	Century	✓	44	H685	5KH39EN2887X	✓	137	H904	5KH32FNA611X	✓	25	HG191	5KH46PN3033	✓	195
H439	5KH39EN2552X	✓	137	H685	Century	✓	175	H905	5KH36JNA769	✓	25	HG196	5KH32GN42S	✓	115
H440	5KH39EN2506X	✓	137	H686	Century	✓	180	H906	5KH36JNA769X	✓	25	HG450	5KH32GNB8126	✓	136
H446	Century	✓	142	H689	5KH35JN603X	✓	27	H907	5KH37NNA768	✓	25	HG455	5KH36NNB16X	✓	37
H450-(GE)	SEE HG450		136	H690-(GE)	SEE HG690		186	H908	5KH37NNA768X	✓	25	HG456	5KH35LNB164	✓	37
H451-(GE)	SEE HG451		136	H691	5KH36LN488X	✓	27	H914	SEE H160		185	HG458	5KH36PNB171	✓	37
HG451	5KH32GNB813X	✓	136	H692-(GE)	SEE HG692		186	H915	5KH33FNA722X	✓	185	HG621	5KH49PN6055X	✓	186
H454	5KH32ENB168	✓	37	H693	5KH46JN0329X	✓	187	H917	5KH35JNA723X	✓	186	HG646	5KH39QN9508Y	✓	112

Index

Catalog Number/Model Number

INDEX

CAT. NO.	MODEL NO.	STOCK	PAGE NO.	CAT. NO.	MODEL NO.	STOCK	PAGE NO.	CAT. NO.	MODEL NO.	STOCK	PAGE NO.	CAT. NO.	MODEL NO.	STOCK	PAGE NO.
HG648	5KHC39QN9581T	✓	115	I314A	184TBFW7041	✓	34,110,224	K027A	056T34D15595	✓	39	K215M2	Century	✓	110
HG679	5KH32DN5597X	✓	136	I315	SEE I315A	✓	34,110,224	K032	056C17E5302	✓	37	K215-(GE)	SEE KG215	✓	46,140,201
HG680	5KH32FN5598X	✓	136	I315A	184TBFW7034	✓	34,110,224	K033	056C11G5303	✓	37	K216	5K36JN57	✓	46,140,201
HG681	5KH32GNB814X	✓	136	I502	143TTGR16026	✓	84	K037	056C17G5308	✓	37	K217	5K36JN56	✓	140
HG690	5KH35JN602X	✓	186	I503	143TTGR16030	✓	84	K041	056T17D5310	✓	40	K218	5K37MN37	✓	46,140,201
HG692	5KH36LN489X	✓	186	I504	145TTGR16076	✓	84	K041A	056T17D15715	✓	40	K219	056B34D5336	✓	223
HG694	5KH39QN9767X	✓	187	I505	145TTGR16080	✓	84	K048	056T34D5340	✓	41	K219-(GE)	SEE KG219	✓	140
HG695	5KH37PNA233	✓	185	I506	143TTGR16001	✓	84	K048A	056T34D15596	✓	41	K220	5K38PN47	✓	46,140,201
HG699	5KH49PN6056S	✓	115	I507	143TTGR16005	✓	84	K049	056T17D2130	✓	39	K220M2	Century	✓	117
HG700	5KHC37NNA167T	✓	186	I508	145TTGR16038	✓	84	K049A	056T17D11046	✓	39	K221	5K38PN48	✓	140
HG701	5KH32DN5618X	✓	185	I509	145TTGR16030	✓	84	K061	056T17D5369	✓	40	K221M2	Century	✓	117
HG703	5KH35MNA519T	✓	187	I512	145TTGR16002	✓	84	K061A	056T17D15913	✓	40	K222	5K46KN2173	✓	46,140,201
HG704	5KH35MNA568T	✓	185	I513	145TTGR16004	✓	84	K062	056T17D5370	✓	40	K222M2	Century	✓	31
HG705	5KH46NN3039T	✓	186	I514	145TTGR16040	✓	84	K062A	056T17D15716	✓	40	K223M2	Century	✓	31
HG706	5KH37PNA569T	✓	186	I515	145TTGR16039	✓	84	K063	056T17D3301	✓	39	K223	5K46KN2172	✓	140
HG710	5KH33JNA511T	✓	187	I700	145TBRF5334	✓	31	K064	056T17D3302	✓	40	K224	5K49NN2180	✓	46,140,201
HG711	5KH32HN5620T	✓	186	I702	145TBRF5336	✓	224	K065	056T17D3303	✓	40	K225	5K49NN2178	✓	140
HG714	5KH37PNA479X	✓	136	I707	143TBRF5376	✓	30	K066	056T17D3304	✓	41	K226	5K48TN2182	✓	46,140,201
HG715	5KH38SNA731T	✓	187	I1104	SEE I104A	✓	25	K067	056T17D3305	✓	39	K227	5K48TN2181	✓	140
HG716	5KH36DNA780X	✓	204	J009	SEE C330	✓	139,201	K068	056T17D3306	✓	40	K228	SEE P101	✓	58,141
HG717	5KH37GNA782X	✓	204	J013	SEE C332	✓	139,201	K069	056T17D3307	✓	40	K229	SEE P102	✓	58,141
I101	143TCDR5303	✓	25	J017	SEE C334	✓	139,201	K080	056T17D3308	✓	41	K230	5K35JN47	✓	141
I102	145TBRF5302	✓	25	J019	SEE C336	✓	139,201	K081	056T17D15528	✓	39	K231	SEE P103	✓	58,141
I103	SEE I103A	✓	25	J021	SEE C338	✓	139,201	K100V1	Century	✓	31	K232	056B17D5322	✓	223
I103A	182TCDW7001	✓	25	J023	SEE C340	✓	139,201	K101V1	Century	✓	31	K232-(GE)	SEE KG232	✓	141
I104	SEE I104A	✓	25	J025	SEE J1025	✓	139,201	K102C	Century	✓	111	K233	SEE K233A	✓	58
I104A	184TBDW17008	✓	25	J033	SEE C329	✓	139	K102V1	Century	✓	111	K233A	056T34F99030	✓	58
I105	213TCDW7001	✓	25,216	J034	SEE C331	✓	139	K103	Century	✓	111	K234	SEE K234	✓	29
I106	215TCDW17002	✓	25	J035	SEE C333	✓	139	K103C	Century	✓	111	K234A	056B17D11040	✓	29
I108A	184TBDW7001	✓	25,216	J036	SEE C335	✓	139	K104	Century	✓	110	K234-(GE)	SEE KG234	✓	141
I110	SEE C188A	✓	24	J037	SEE C337	✓	139	K107	Century	✓	33	K235	SEE K235A	✓	29
I111	SEE C191	✓	25	J038	SEE C339	✓	139	K108	Century	✓	33	K235A	056B17D11035	✓	29
I112A	182TCDW7026	✓	25	J039	SEE C341	✓	139	K111	SEE G044A	✓	39	K235-(GE)	SEE KG235	✓	58
I113	SEE I113A	✓	25	J040	SEE K748	✓	140	K112V1	Century	✓	170	K236	SEE E261A	✓	29
I113A	184TCDW7026	✓	25	J041	SEE K217	✓	140	K113	SEE K113A	✓	39	K236M2	Century	✓	117
I114	SEE I114A	✓	25,216	J042	SEE KG219	✓	140	K113A	048T34D11001	✓	39	K236-(GE)	SEE KG236	✓	141
I114A	184TBDW7026	✓	25,216	J043	SEE K221	✓	140	K114	SEE G047A	✓	39	K237	SEE E270A	✓	29
I115	215TBDW7026	✓	25,216	J044	SEE K223	✓	140	K115	SEE K115A	✓	39	K237-(GE)	SEE KG237A	✓	59
I116	215TBDW7028	✓	25,216	J045	SEE K225	✓	140	K115A	048T34D11002	✓	39	K238	SEE K238A	✓	141
I117	213TCDW7026	✓	25	J046	SEE K227	✓	140	K115V1	Century	✓	33	K238A	056T34F99028	✓	141
I118	SEE C193A	✓	25	J047	056T34D5368	✓	140	K116-(ME)	SEE G063A	✓	39	K239	SEE P107A	✓	59,141
I119	184TBDW7375	✓	216,223	J048	056T34D5367	✓	140	K116	Century	✓	170	K240	5K49ZM2190	✓	141
I127	145TBRF5337	✓	25,216,223	J049	056T34D5365	✓	140	K117	SEE G067A	✓	39	K240A	056T34F15597	✓	141
I128	SEE I128A	✓	223	J050	056T34D5366	✓	140	K118	SEE G080A	✓	39	K247	SEE K247A	✓	46
I128A	184TBDW7631	✓	223	J051	056T34D5369	✓	140	K119	SEE G084A	✓	39	K247A	056T17D11053	✓	46
I130	SEE I130A	✓	223	J052	056T34D5370	✓	140	K120	SEE G088A	✓	39	K248	SEE K248A	✓	46
I130A	184TBDW7630	✓	223	J053	056T34D5371	✓	140	K121	SEE K000A	✓	39	K248A	056T17D11050	✓	46
I131	SEE I131A	✓	223	J054	056C34D2118	✓	139	K122	5K46MN4072	✓	39	K249	5K42HN4127	✓	46
I131A	184TBDW7632	✓	223	J055	056C34D2119	✓	139	K125	SEE K022	✓	41	K249A	056T17D15909	✓	46
I141	SEE I141A	✓	24	J056	056C34D2120	✓	139	K126	SEE K025A	✓	41	K250	5K46KN4125	✓	46
I141A	182TCDW17084	✓	24	J057	056C34D2121	✓	139	K136	SEE C1157	✓	191	K250A	056T17D15906	✓	46
I142	184TCDR7076	✓	25	J058	056B34D2033	✓	139	K151	5K32GN30	✓	52	K251	SEE K251A	✓	46
I143	213TCDW7076	✓	25	J059	056B34D5341	✓	139	K152	056B34D5320	✓	191	K251A	056T17D15916	✓	46
I144	215TBDW7079	✓	25	J060	056T34F5308	✓	141	K153	5K33FN30	✓	52	K252	5K49DN4130	✓	58
I145	145TBRF5303	✓	27	J061	056T34F5342	✓	141	K154	5K49FN4136	✓	52	K253	5K33JNA943	✓	58
I146	145TCDR5331	✓	191	J062	056T34F5343	✓	141	K155	5K36PN30	✓	52	K254	5K35MNB114	✓	58
I147	145TBRF5345	✓	191	J063	056T34F5344	✓	141	K158	5K35MNB117	✓	52	K255	5K36PNB116	✓	58
I201	145TBRF5327	✓	30	J063A	056T34F99029	✓	141	K159	5K49MN6079	✓	52	K256	5K49MN4104	✓	58
I204	145TBRF5301	✓	31	J064	056T34F5345	✓	141	K160	5K37NN30	✓	53	K257	5K49SNA117	✓	58
I205	145TBRF5302	✓	31	J064A	056T34F99018	✓	141	K161	5K36PNB111	✓	53	K258	5K49KN4124	✓	60
I206	182TBRF5301	✓	31	J065	056T34F5346	✓	141	K162	5K46PN6082	✓	53	K259	SEE G563A	✓	60
I210	SEE C295	✓	30	J065A	056T34F15592	✓	141	K163	5K38RN30	✓	53	K260	SEE G564A	✓	61
I211	SEE C297	✓	31	J066	SEE J066A	✓	141	K164	SEE G347A	✓	53	K275	5K33GN45	✓	196
I212	182TBRF5326	✓	31	J066A	056T34F15601	✓	141	K165	SEE G360A	✓	53	K277	5K46KN4085	✓	196
I213	SEE I213A	✓	31	J1025	5K37FN71X	✓	139,201	K166	SEE G383A	✓	53	K278	5K46MN4087	✓	196
I213A	184TBFW17044	✓	31	K000	SEE K000A	✓	39	K167	SEE G365A	✓	53	K279	5K49PN3053	✓	196
I214	SEE I214A	✓	31	K000A	056T34D15600	✓	39	K194	5K33KN92	✓	52	K280	5K49PN3052	✓	196
I214A	184TBFW7726	✓	31	K003	SEE K003A	✓	39	K196	5K49FN4129	✓	52	K281	5K32GN48	✓	195
I215	215TBFW7026	✓	31	K003A	056T17D11047	✓	39	K197	5K42HN4109	✓	52	K282	5K35MN294	✓	195
I216	213TBFW7026	✓	31	K004	056T17D2092	✓	39	K198	5K49PN4113	✓	53	K283	5K33KN52	✓	195
I217	215TBFW7027	✓	31	K004A	056T17D15915	✓	39	K200M2	Century	✓	31	K284	5K42HN4128	✓	195
I220	143TBRF5301	✓	30	K007	056T11D5304	✓	40	K203	056T17D15945	✓	47	K285	5K49MN6080	✓	195
I221	145TBRF5303	✓	31	K007A	056T11D15526	✓	40	K203M2	Century	✓	31	K286	5K49KN4142	✓	195
I223	SEE I223A	✓	31	K009	056T34D5303	✓	40	K204M2	Century	✓	111	K300M2	Century	✓	111
I223A	184TBFW7701	✓	31	K009A	056T34D15599	✓	40	K205M2	Century	✓	111	K301M2	Century	✓	111
I224	213TBFW7001	✓	31	K016	056B17D56	✓	216,223	K205CM2	Century	✓	111	K301CM2	Century	✓	111
I225	215TBFW7001	✓	31	K022	056T17D5309	✓	40	K208M2	Century	✓	111	K302M2	Century	✓	111
I305	184TBRF628	✓	223	K022A	056T17D15911	✓	40	K208CM2	Century	✓	111	K302CM2	Century	✓	111
I308	184TBRF634	✓	223	K025	056T34D5304	✓	40	K212	056B34D2018	✓	223	K305M2	Century	✓	31
I311	145TBRF5333	✓	224	K025A	056T34D15598	✓	40	K213M2	Century	✓	110	K310M2	Century	✓	110
I314	SEE I314A	✓	34,110,224	K027	SEE K027A	✓	39	K214M2	Century	✓	110	K311M2	Century	✓	110

CAT. NO.	MODEL NO.	STOCK	PAGE NO.	CAT. NO.	MODEL NO.	STOCK	PAGE NO.	CAT. NO.	MODEL NO.	STOCK	PAGE NO.	CAT. NO.	MODEL NO.	STOCK	PAGE NO.
K312M2	Century	✓	110	K541	5K49MN6081	✓	195	K1150	Century	✓	138	K2016	SEE E2107		54
K313M2	Century	✓	120	K544	5K42JN3051	✓	196	K1152	Century	✓	138	K2017	SEE E2132		54
K314M2	Century	✓	120	K546	5K42JN3050	✓	196	K1200	Century	✓	138	K2018	SEE K2018A		46
K315M2	Century	✓	31	K549	5K48UN3057	✓	196	K1202	Century	✓	138	K2018A	143TTDR16021	✓	46
K318	5K42JN4163	✓	39	K550	5K42HN4133	✓	141	K1221	SEE GT1305		69	K2019	SEE C102B		46
K319	056B17F5319	✓	34, 110, 224	K553	5K42HN4139	✓	140	K1222	SEE K701A		60	K2020	SEE C103A		46
K319-(GE)	SEE KG319		225	K555	5K46KN4141	✓	140	K1299	SEE K1299A		46	K2021	SEE K2021A		47
K320M2	Century	✓	117	K578	SEE X500		179	K1299A	056T11D15523	✓	46	K2021A	143TTDR16068	✓	47
K321	5K35MN75	✓	52	K606	5K42GN4619X	✓	73	K1300	5K49PN6019	✓	46	K2022	SEE K2022A		47
K321M2	Century	✓	117	K607	5K49MN4620X	✓	73	K1300A	056T11D15524	✓	46	K2022A	145TTDR16365	✓	47
K327M2	Century	✓	117	K608	SEE K608A		73	K1305	SEE K1305A		47	K2023	SEE K2023A		47
K330	SEE C222A		59	K608A	056T17W99021	✓	73	K1305A	056T17D11052	✓	47	K2023A	145TTDR16366	✓	47
K332	056B34F5303		224	K609	5K49TN4622	✓	73	K1306	SEE K1306A		47	K2024	SEE C150B		46
K339	056C34F5327		30	K609A	056T17W99024	✓	73	K1306A	056T34D15603	✓	47	K2025	SEE C201B		58
K350	056B34F5322		31	K610	SEE K610A		73	K1307	SEE K1307A		47	K2026	SEE GT1203		70
K378	5K46LN6033S		179	K610A	056T17W99023	✓	73	K1307A	056T17D15910	✓	47	K2027	SEE C202B		59
K379	5K49RN6034S		179	K612	056B34F5306	✓	224	K1308	SEE K1308A		47	K2028	SEE GT1206		70
K380	SEE X503		179	K615	056B34F5312	✓	224	K1308A	056T17D15907	✓	47	K2029	SEE C220B		58
K381	5K42HN4089	✓	196	K618	056B34F5318	✓	224	K1311	SEE K1311A		47	K2030	SEE K2030A		196
K387	SEE G065A		39	K622	SEE K622B		46	K1311A	056T34D15602	✓	47	K2030A	---		196
K392	SEE G086A		39	K622A	145TTDR14049	✓	46	K1314	SEE G586		60	K2031	SEE GT1204		70
K393	SEE K007A		41	K622B	145TTDR16360	✓	46	K1315	SEE G587		60	K2032	SEE GT1201		70
K402	SEE H181		39	K631	056B34F5324		34	K1316	5K49MN6020	✓	58	K2033	5KE48WN8365	✓	58
K404	056T11F5320		58	K633	5K36MN4152	✓	58	K1317	5K49PN6025	✓	58	K2034	SEE GT1207		70
K405	056T17F2047		58	K634A	143TTDR14049	✓	46	K1318	5K49PN8030	✓	58	K2035	SEE C250B		58
K406	SEE K640A		59	K634B	143TTDR16057	✓	46	K1322	5K42FN4035	✓	60	K2036	SEE GT1202		70
K407	SEE K407A		58	K635	SEE K635A		47	K1323	SEE D391		60	K2037	SEE K2037A		196
K407A	056T11F15527	✓	58	K635A	056T17D15917	✓	47	K1324	5K42HN4034	✓	60	K2037A	---		196
K408	5K49SN8050	✓	40	K637	SEE P106A		59, 141	K1325	SEE G588		60	K2039	SEE GT1201		70
K418	5K32GN53	✓	52	K640	5K49DN4609	✓	59	K1326	SEE G589		60	K2042	SEE C236B		59
K420	SEE K151		52	K640A	182TTFW16049	✓	59	K1328	SEE D394A		61	K2043	SEE C122B		46
K421-(GE)	SEE G1340		53	K642	SEE P105A		58, 141	K1333	SEE J061		141	K2044	145TFR16096		108
K424	SEE G348A		53	K644	SEE K644A		46	K1402	5K39SNB505S	✓	179	K2045	SEE K2045A		108
K426	5K42HN4134	✓	52	K644A	056T17D15718	✓	46	K1403	5K36PN345S	✓	179	K2045A	145TFR16361	✓	108
K435	056T11F15533		108	K646	SEE K646A		47	K1404	5K38SN267S	✓	179	K2046	5KE49WN4572	✓	108
K436	056T17F15920		108	K646A	056T17D15914	✓	47	K1405	5K39SNB765T	✓	179	K2046A	145TFR16362	✓	108
K437	056T11F15534		108	K648	SEE K648A		47	K1407	5K39SNB587S	✓	179	K2048	SEE C221B		58
K438	056T17F15919		108	K648A	056T17D15717	✓	47	K1408	5K42HN4089X	✓	196	K2049	SEE E2106		54
K439	5K49DN4131	✓	52	K690	SEE K690A		47	K1409	5K37MN252X	✓	196	K2051	SEE N323		122
K440	056T17F15915		108	K690A	056T34D15601	✓	47	K1410	5K46KN4085X	✓	196	K2052	SEE N321A		122
K441	145TFR16431		108	K700	SEE K700A		61	K1411	5K38PN258X	✓	196	K2053	SEE N312A		122
K455	056T17F15921		108	K700A	182TTFW16085	✓	61	K1412	5K46MN4087X	✓	196	K2055	SEE N650A		123
K456	5K49KN4573	✓	108	K701	SEE K701A		60	K1413	5K49KN2150X	✓	196	K2056	SEE N654B		123
K457	5K49KN4563	✓	108	K701A	056T11F15521	✓	60	K1415	5K49PN4088X	✓	196	K2058	SEE N607A		124
K458	5K49PN4564	✓	108	K702	056T34T5309		60	K1416	5K49NN2147X	✓	196	K2059	SEE N629A		124
K459	SEE K459A		108	K703	056T17T5316	✓	60	K1418	5K49UN4086X	✓	196	K2060	SEE N610A		124
K459A	056T17F99015	✓	108	K704	056T34F5348	✓	60	K1438	5K49NN4052T	✓	118	K2061	SEE N612A		124
K460	5K49PN4565	✓	108	K705	056T17F5336	✓	60	K1438B	056T17F15659	✓	118	K2062	SEE N630		124
K461	5K49UN4566	✓	108	K706	056T34F5349	✓	60	K1476	5K49JN4051T	✓	118	K2063	SEE N613A		124
K461A	143TFR16065	✓	108	K707	056T17F5337	✓	60	K1476B	056T17F15902	✓	118	K2064	SEE G347A		53
K462	SEE K462A		108	K708	SEE K708A		60	K1482	5K48WN3013S	✓	179	K2065	SEE N611A		124
K462A	143TFR16066	✓	108	K708A	056T34F99010	✓	60	K1483	5K37MN3543	✓	140	K2066	SEE N653A		123
K463	056T17F15916		108	K709	SEE K709A		60	K1484	5K46KN2082	✓	140	K2067	SEE N606A		124
K465	056T17F15918		108	K709A	056T17F15642	✓	60	K1485	5K49RN6118S		178	K2068	SEE N649A		123
K466	056T11F15532		108	K717	5K32GNB249X	✓	84	K1486	5K48TN6119S	✓	178	K2069	SEE K004A		39
K467	056T17F15914		108	K718	SEE G647		84	K1487	5K49MN6126T	✓	204	K2084	SEE C222A		59
K468	056T11F15535		108	K721	SEE K721A		61	K1490	5K49PN6164	✓	58	K2085	SEE Y366		91
K469	5K42HN4137	✓	58	K721A	056T34F99020	✓	61	K1491	5K49ZNA253	✓	59	K2087	SEE Y368		91
K470	056T17F15913		108	K722	056T17F5339	✓	61	K1492	SEE G369A		54	K2088	SEE GT1209A		70
K471	056T11F15531		108	K722A	056T17F15645	✓	61	K1494	5K49RN4570	✓	108	K2090	SEE G544A		59
K472	056T17F15917		108	K723	SEE K723A		61	K1494A	056T17F99014	✓	108	K2101	5K49FN6381X	✓	84
K473	145TFR16095		108	K723A	056T34F99015	✓	61	K1497	5K49WN4335X	✓	196	K2102	5K49JN4582X		84
K474	145TFR16430		108	K724	SEE K724A		61	K1500	5K49MN6432S	✓	179	K2103	SEE G649		84
K476	145TFR16429		108	K724A	056T17F15644	✓	61	K1505	5K46LN6428S	✓	179	K2104	5K49HN6385X	✓	84
K499	SEE D392		60	K725	SEE K725A		61	K1510	5K49RN6429S		179	K2105	5K49JN4574X	✓	84
K500	SEE K500A		60	K725A	056T34F15593	✓	61	K1511	5K48WN3181S		179, 203	K2106	SEE G661		84
K500A	056T34F15598	✓	60	K748	5K35FN101	✓	140	K1515	5K48TN6430S		179	K2107	5K49MN8349X	✓	84
K501	SEE D395A		61	K750	5K46MN4144	✓	140	K1520	5K49ZNA6433S		179	K2108	SEE G662A		84
K518	5K49SN3054	✓	196	K751	5K49PN4121	✓	140	K2001	SEE E783A		40	K2109	SEE G663A		84
K519	5K49SN3055	✓	196	K803	SEE K500A		60	K2002	SEE U246		40	K2110	5K49TN6383	✓	84
K520	5K48UN3056	✓	196	K806	SEE K806A		61	K2003	SEE U247		41	K2110A	056T11G15528	✓	84
K521	SEE K521A		46	K806A	056T17F15646	✓	61	K2004	SEE U1248		41	K2111	SEE K2111A		84
K521A	056T17D15912	✓	46	K1030	Century	✓	138	K2005	SEE U758		40	K2111A	056T17G15602	✓	84
K522	5K33KN67	✓	58	K1032	Century	✓	138	K2006	SEE U759		40	K2112	SEE G829		85
K523	5K36PN254	✓	58	K1034LV1	Century	✓	28	K2007	SEE U760		40	K2113	SEE G840		85
K524	5K49MN4112	✓	58	K1050	Century	✓	138	K2010	SEE E914A		40	K2114	SEE G841A		85
K525	5K49MN4114	✓	195	K1052	Century	✓	138	K2011	SEE E2109		54	K2115	SEE K2115A		85
K525A	056T17F15661	✓	195	K1070	Century	✓	138	K2012	SEE E2101		53	K2115A	056T17G15601		85
K526	5K49MN6369	✓	108	K1072	Century	✓	138	K2013	SEE E2126		53	K2116	5K49MN6382X	✓	84
K527	SEE K527A		39	K1100	Century	✓	138	K2014	SEE E2104		53	K2201	SEE I502		84
K527A	048T17D11010	✓	39	K1102	Century	✓	138	K2015	SEE E2129		53	K2202	SEE I504		84

Index

Catalog Number/Model Number

INDEX

CAT. NO.	MODEL NO.	STOCK	PAGE NO.	CAT. NO.	MODEL NO.	STOCK	PAGE NO.	CAT. NO.	MODEL NO.	STOCK	PAGE NO.	CAT. NO.	MODEL NO.	STOCK	PAGE NO.
K2203	SEE I506		84	M102	SEE GT4401		154	M362	SEE GT0412		147	M765	---		167
K2205	SEE I512		84	M103	SEE GT2403		154	M363	SEE E153B		147	M766	---		167
K2206	SEE I514		84	M105	SEE GT2404		154	M401	SEE GT3101		150	M767	---		167
KG215	5K35FN55	✓	46,140,201	M109	SEE GT2407		154	M402	SEE GT3104		150	M768	---		167
KG219	5K37MN38	✓	140	M110	SEE GT4407		154	M403	SEE GT3106		150	M769	---		167
KG232	5K36MN339	✓	141	M111	SEE GT2409		154	M404	SEE GT3107		151	M770	---		167
KG234	SEE KG234A		141	M113	SEE GT2410		155	M405	SEE GT3109		151	M771	---		167
KG234A	056T34F99023	✓	141	M114	SEE GT2412		155	M406	SEE GT3110		151	M773	---		167
KG235	5K49PN2348	✓	58	M115	SEE GT2413		155	M407	SEE GT3112		151	M774	---		167
KG236	5K49PN2330	✓	141	M115A	SEE GT2413		155	M408	SEE GT3113		151	M800B	---		166
KG236A	056T34F99031	✓	141	M116	SEE GT2415A		155	M409	SEE GT3115A		151	M801A	SEE M801B		166
KG237	5K49SN2187	✓	59	M117	SEE GT2416A		155	M410	SEE GT3116A		151	M801B	---		166
KG237A	056T34F99021	✓	59	M118	SEE GT2418A		155	M411	SEE GT3118A		151	M802A	SEE M802B		166
KG319	5K49UN8052	✓	225	M119	SEE GT2419A		156	M412	SEE GT3119A		152	M802B	213TTDWD16089		166
L102	SEE E904B		41	M120	SEE U201B		156	M413	SEE U344A		152	M803A	SEE M803B		166
L409A	SEE L409B		53	M121	SEE U207A		156	M414	SEE U351A		152	M803B	---		166
L409B	182TTFN16101	✓	53	M122	SEE U210A		156	M415	SEE GT3103		150	M804A	SEE M804B		166
L410A	184TTFN14101	✓	53	M123	SEE U213		156	M416	SEE U360A		151	M804B	184TTDWD16338		166
L410B	SEE L410C		53	M124	SEE U219A		156	M416A	SEE U360A		151	M805A	SEE M805B		166
L410C	184TTFN16105	✓	53	M125	SEE U225A		157	M417	SEE U357A		152	M805B	215TTDWD16091		166
L411A	SEE L411B		54	M126	SEE GT2465		157	M418	SEE U363A		151	M806B	---		166
L411B	213TTFN16101	✓	54	M127	SEE GT2469		157	M420	SEE U348A		152	M807A	SEE M807B		166
L412	SEE L412A		54	M128	SEE GT2467		157	M421	SEE U348A		152	M807B	213TTDWD16342		166
L412A	254TTFNA14103	✓	54	M129	SEE GT2472		157	M422	SEE GT3110		151	M808A	SEE M808B		166
L413A	256TTFNA14101	✓	55	M130	SEE GT2473		157	M423	SEE GT3112		151	M808B	254TTDWD16086		166
L413B	256TTFNA16101	✓	55	M131	SEE GT2477		157	M708	---		166	M809B	---		166
L414	SEE L414A		55	M133	SEE GT2476		157	M711	256TTDN16082		166	M810A	SEE M810B		166
L414A	284TTFNA14102	✓	55	M163	SEE U299A		155	M712	---		166	M810B	215TTDWD16350		166
L415A	SEE L415B		55	M165	SEE U186A		155	M714	---		166	M811A	SEE M811B		166
L415B	286TTFNA16106	✓	55	M166	SEE U192A		155	M715	284TTDN16087		166	M811B	---		166
L416A	SEE L416B		56	M167	SEE U198A		156	M716	---		166	M813A	SEE M813B		166
L416B	324TTFN16105	✓	56	M168	SEE U204		156	M717	---		166	M813B	215TTDWD14018		166
L417A	SEE L417B		56	M170	SEE GT2410		155	M718	SEE M718A		166	M814A	SEE M814B		166
L417B	326TTFN16102	✓	56	M171	SEE U162A		155	M718A	256TTDN16067		166	M814B	254TTDX16054		166
L420	364TTFN16101	✓	56	M172	SEE GT2412		155	M719	286TTDN16093		166	M815A	SEE M715		166
L420A	364TTFN16104	✓	56	M213	SEE U345B		160	M720	324TTDN16101		166	M817B	---		166
L421A	SEE L421B		54	M216	SEE GT3415A		159	M721	SEE M721A		166	M818A	SEE M818B		166
L421B	215TTFN16101	✓	54	M217	SEE GT2421A		156	M721A	256TTDN16018		166	M818B	256TTDR16029		166
L425	365TTFN16105	✓	56	M301	SEE GT0401		146	M722	284TTDN16063		166	M819A	SEE M719		166
L425A	365TTFN16103	✓	56	M302	SEE GT4101		146	M723	324TTDN16077		166	M820	SEE M820B		166
L426	404TTFN16102	✓	56	M303	SEE GT0403		146	M724	326TTDN16101		166	M820B	---		166
L426A	404TTFN16103	✓	56	M304	SEE GT4103		146	M725	284TTDN16007		166	M821	SEE M821B		166
L427	SEE L427A		57	M305	SEE GT0404		146	M726	286TTDN16330		166	M821B	---		166
L427A	405TTFN16103	✓	57	M306	SEE GT4104		146	M727	---		166	M822A	SEE M722		166
L428	SEE L428A		57	M307	SEE GT0406		146	M728	364TTDS16105		166	M823A	SEE M823B		166
L428A	444TTFN16102	✓	57	M308	SEE GT4106		146	M729	286TTDN16011		167	M823B	324TTDR16091		166
L429	445TTFN16115	✓	57	M309	SEE GT0407		146	M730	---		167	M824A	SEE M824B		166
L440	SEE L440A		57	M310	SEE GT4107		146	M731	364TTDS16088		167	M824B	326TTDR16102		166
L440A	445TTFN16108	✓	57	M311	SEE GT0409		147	M732	365TTDS16101		167	M825A	SEE M725		166
L442	449TTFN16111	✓	57	M312	SEE GT4109		147	M733	---		167	M826A	SEE M726		166
L449	449TTFN16110	✓	57	M313	SEE GT0410		147	M734	326TTDN16035		167	M827B	---		166
L450	SEE E271		57	M314	SEE E148B		147	M735	365TTDS16086		167	M828A	SEE M728		167
L451	SEE E271		57	M315	SEE M315C		147	M736	404TTDS16102		167	M829	SEE M729		167
L451A	SEE E271		57	M315C	182TTDWD16018	✓	147	M737	---		167	M830A	SEE M830B		167
L452	SEE E276		57	M316	SEE M316B		147	M738	364TTDS16052		167	M830B	324TTDR16056		167
L453	SEE E329		57	M316B	182TTDWD17008	✓	147	M739	404TTDS16093		167	M831A	SEE M731		167
L454	SEE E276		57	M317	SEE GT0413		147	M740	405TTDS16102		167	M832A	SEE M732		167
L455	SEE L455A		57	M318	SEE E158B		147	M741	364TTDS16009		167	M833A	SEE M833B		167
L455A	449TTFN16362	✓	57	M319	SEE GT0415		147	M742	365TTDS16072		167	M833B	324TTDR16007		167
L456	SEE E283		57	M320	SEE E163B		147	M743	405TTDS16089		167	M834A	SEE M734		167
L457	SEE L457A		57	M321	SEE GT0416A		147	M744	444TTDN16101		167	M835A	SEE M735		167
L457A	449TTFN16384	✓	57	M322	SEE E168A		147	M745	365TTDS16016		167	M836A	SEE M736		167
L459	SEE E272		57	M323	SEE GT0418A		148	M746	404TTDS16332		167	M837A	SEE M837B		167
L460	SEE E277		57	M324	SEE E173A		148	M747	444TTDN16078		167	M837B	326TTDR16005		167
L461	SEE L472		57	M325	SEE GT0419A		148	M748	445TTDN16101		167	M838A	SEE M738		167
L462	SEE E277		57	M326	SEE E178A		148	M749	404TTDS16010		167	M839A	SEE M739		167
L463	SEE L463A		57	M327	SEE E113A		148	M750	405TTDS16070		167	M840	SEE M740		167
L4633A	449TTFN16374	✓	57	M328	SEE E183A		148	M751	445TTDN16080		167	M841A	SEE M741		167
L464	SEE E284		57	M329	SEE E114B		148	M752	505UTDS16102		167	M842A	SEE M742		167
L465	SEE L465A		57	M330	SEE E191		148	M753	405TTDS16010		167	M843A	SEE M743		167
L465A	449TTFN16385	✓	57	M331	SEE E197A		149	M754	444TTDN16027		167	M844A	SEE M744		167
L466	SEE E273		57	M332	SEE U103A		149	M755	445TTDN16079		167	M845A	SEE M745		167
L467	SEE E293		57	M333	SEE GT2510		155	M756	505UTDS16103		167	M846B	SEE M746		167
L469A	SEE L469B		57	M334	SEE U109A		149	M757	444TTDN16003		167	M847A	SEE M747		167
L469B	449TTFN16364	✓	57	M335	SEE GT0472		149	M758	445TTDN16031		167	M848	SEE M748		167
L471	SEE L471A		57	M351	SEE GT0467		149	M759	505UTDS16076		167	M849A	SEE M749		167
L471A	449TTFN16102	✓	57	M352	SEE GT0473		149	M760	505UTDS16101		167	M850A	SEE M750		167
L472	SEE L472A		57	M353	SEE GT4101		149	M761	445TTDN16002		167	M851A	SEE M751		167
L472A	449TTFN16365	✓	57	M358	SEE GT0476		149	M762	445TTDN16032		167	M852	SEE M752		167
L633	SEE E2160		54	M360	SEE GT0410		147	M763	508UTDS16078		167	M853A	SEE M753		167
M101	SEE GT2401		154	M361	SEE E148B		147	M764	---		167	M854A	SEE M754		167

CAT. NO.	MODEL NO.	STOCK	PAGE NO.	CAT. NO.	MODEL NO.	STOCK	PAGE NO.	CAT. NO.	MODEL NO.	STOCK	PAGE NO.	CAT. NO.	MODEL NO.	STOCK	PAGE NO.
M855A	SEE M755		167	M909A	326TFFA14049		168	N162	SEE N162A		133	N310A	143TTWR16028	✓	122
M856	SEE M756		167	M909B	326TFFS16037		168	N162A	215TTWD16003	✓	133	N312	SEE N312A		122
M857A	SEE M757		167	M910A	SEE M910B		168	N163	SEE N163A		133	N312A	145TTWR6027	✓	122
M858A	SEE M758		167	M910B	365TFFS16088		168	N163A	215TTWD16026	✓	133	N313	SEE N314B		122
M859A	SEE M759		167	M911B	---		169	N180	SEE N180A		132	N314B	182TTWW6027	✓	122
M860	SEE M760		167	M912A	SEE M912B		169	N180A	056T11V5379	✓	132	N315	SEE N315A		122
M861A	SEE M761		167	M912B	364TFFS16008		169	N181	SEE N181A		132	N315A	184TTWW6004	✓	122
M862A	SEE M762		167	M913A	SEE M913B		169	N181A	056T11V5380	✓	132	N316	SEE N316B		122
M863A	SEE M763		167	M913B	364TFFS6059		169	N182A	056T11W5379	✓	132	N316B	184TTWW6027	✓	122
M864	SEE M764		167	M914A	SEE M914B		169	N182B	056T11W99004	✓	132	N317	SEE N317A		122
M865	SEE M765		167	M914B	404TFFS16086		169	N183A	056T11W5380	✓	132	N317A	184TTWW6003	✓	122
M866A	SEE M766		167	M915B	---		169	N183B	182TTWD16076	✓	132	N318	SEE N318A		122
M867A	SEE M767		167	M916	SEE M916B		169	N201	143TTWR14032	✓	125	N318A	213TTWR6027	✓	122
M868	SEE M768		167	M916B	365TFFS16013		169	N201A	143TTWR16029	✓	125	N318B	213TTWRD6027	✓	122
M869A	SEE M769		167	M917A	SEE M917B		169	N202	143TTWR14002	✓	125	N319	SEE N319A		122
M870	SEE M770		167	M917B	365TFFS16132		169	N202A	---	✓	125	N319A	215TTWR6027	✓	122
M871A	SEE M771		167	M918A	SEE M918B		169	N203	143TTWR14031	✓	125	N319B	215TTWRD6027	✓	122
M873	SEE M773		167	M918B	405TFFS16082		169	N203A	143TTWR16027	✓	125	N320	056T17W5340	✓	122
M874	SEE M774		167	M919	SEE M919B		169	N204	145TTWR14003	✓	125	N321	SEE N321A		122
M875A	SEE M875B		168	M919B	444TFFN16103		169	N204A	145TTWR16007	✓	125	N321A	145TTWR6029	✓	122
M875B	182TFFR16017		168	M920	SEE M920B		169	N205	145TTWR14031	✓	125	N322	056T17W5344	✓	122
M876	SEE M876A		168	M920B	405TFFS16004		169	N205A	145TTWR16030	✓	125	N323	145TTWR6076	✓	122
M876A	SEE M876B		168	M921A	SEE M921B		169	N206	145TTWR14004	✓	125	N324	145TTWR16002	✓	122
M876B	---		168	M921B	405TFFS16129		169	N206A	145TTWR16006	✓	125	N325	213TTWW16002	✓	122
M877A	SEE M877B		168	M922A	SEE M922B		169	N207	182TTWW14031	✓	125	N326	056T17W99025	✓	122
M877B	213TFFW16085		168	M922B	444TFFN16081		169	N207A	182TTWW16027	✓	125	N340	056C34WD5301	✓	127
M878B	---		168	M923B	---		169	N208	184TTWW14005	✓	125	N341	056C17WD5327	✓	127
M879A	SEE M879B		168	M924A	SEE M924B		169	N208A	184TTWW16005	✓	125	N342	056C34WD5302	✓	127
M879B	184TFFR16054		168	M924B	444TFFN16001		169	N209	SEE N209A		125	N343	056C17WD5328	✓	127
M880A	SEE M880B		168	M925A	SEE M925B		169	N209A	184TTWW16027	✓	125	N344	056C34WD5303	✓	127
M880B	215TFFWD16084		168	M925B	444TFFN16045		169	N210	SEE N210A		125	N345	056C17WD5329	✓	127
M881A	SEE M881B		168	M926A	SEE M926B		169	N210A	184TTWW16006	✓	125	N346	056C34WD5304	✓	127
M881B	213TFFWD16016		168	M926B	445TFFN16091		169	N211	213TTWW14031	✓	125	N347	056C17WD5330	✓	127
M882B	---		168	M927B	---		169	N211A	213TTWW16026	✓	125	N348	145TBWD5305	✓	127
M883A	SEE M883B		168	M928A	SEE M928B		169	N212	215TTWW14009	✓	125	N349	145TBWD5335	✓	127
M883B	254TFFNA16088		168	M928B	445TFFN16001		169	N212A	215TTWW16005	✓	125	N351	056T17W99006	✓	126
M884A	SEE M884B		168	M929A	SEE M929B		169	N213	SEE N213A		125	N353	056T17V99007	✓	126
M884B	215TFFWD16017		168	M929B	445TFFN16361		169	N213A	215TTWW16026	✓	125	N355	056T17V99008	✓	126
M885A	SEE M885B		168	M930B	---		169	N214	215TTWW14007	✓	125	N357	SEE N363		126
M885B	---		168	M931	SEE M931B		169	N214A	215TTWW16007	✓	125	N358	SEE N358A		126
M886A	SEE M886B		168	M931B	449TFFS16106		169	N220	056T34W99003	✓	125	N358A	143TTVR16026	✓	126
M886B	256TFFNA16099		168	M932B	---		169	N222	056T34W99004	✓	125	N360	145TTWR14032	✓	126
M887B	---		168	M933A	SEE M933B		169	N224	056T34W99005	✓	125	N360A	145TTWR16033	✓	126
M888	SEE M888B		168	M933B	445TFFN16359		169	N224A	056T34W99021	✓	125	N362	145TTWR14033	✓	126
M888B	---		168	M1114	SEE GT2412		155	N226	056T34W99006	✓	125	N362A	145TTWR16034	✓	126
M889	SEE M889B		168	M1116	SEE GT2415A		155	N226A	056T34W99023	✓	125	N363	056T17W99047	✓	126
M889B	---		168	M1216	SEE GT3415A		159	N228	056T34W99009	✓	125	N371	056T17V99003	✓	126
M890A	SEE M890B		168	M1314	SEE E1488		147	N228A	056T34W99017	✓	125	N373	056T17V99004	✓	126
M890B	284TFFA16033		168	M1315	SEE M315C		147	N230	056T34W99007	✓	125	N375	056T17V99002	✓	126
M892	SEE M892A		168	M1316A	SEE M316B		147	N232	056T34W99010	✓	125	N377	056T17V99009	✓	126
M891B	---		168	M1317	SEE GT0413		147	N234	056T34W99011	✓	125	N378	143TTVR5330	✓	126
M892A	SEE M892B		168	M1318	SEE E158B		147	N234A	056T34W99018	✓	125	N380	SEE N380A		126
M892B	256TFFNA16106		168	M1319	SEE GT0415		147	N236	056T34W99008	✓	125	N380A	145TTWR16031	✓	126
M893	SEE M893B		168	M1320	SEE E163B		147	N236A	056T34W99019	✓	125	N382	145TTWR17032	✓	126
M893B	256TFFNA16031		168	M1322	SEE E168A		147	N238	SEE N238A		125	N382A	145TTWR16032	✓	126
M894A	SEE M894B		168	M1323	SEE GT0418A		148	N238A	056T34W99024	✓	125	N383	056T17W99046	✓	126
M894B	286TFFNA16096		168	M1327	SEE E113A		148	N270	056C17V5304	✓	130	N384	143TTWR16031	✓	126
M895B	---		168	M1407	SEE GT3112		151	N271	056C17V5302	✓	130	N388A	056T17V5354	✓	133
M896	SEE M896B		168	M1408	SEE GT3113		151	N272	056B17V5301	✓	130	N389A	SEE N389B		133
M896B	284TFFNA16015		168	N151	SEE N151A		133	N273	056B17V5302	✓	130	N389B	056T17V99029	✓	133
M897A	SEE M897B		168	N151A	143TTWD16038	✓	133	N274	145TBWD5327	✓	130	N400	056T17V5347	✓	132
M897B	284TFFNA16131		168	N152	SEE N152A		133	N275	145TBWD5326	✓	130	N401	056T17V5348	✓	132
M898A	SEE M898B		168	N152A	143TTWD16006	✓	133	N280	056C17V5303	✓	130	N402	056T17V5349	✓	132
M898B	324TFFS16087		168	N153	145TTWD14031	✓	133	N281	056C34V5302	✓	130	N402A	056T17W99041	✓	132
M899A	SEE M899B		168	N153A	145TTWD16035	✓	133	N282	056C17V5301	✓	130	N403	SEE N403A		132
M899B	326TFFS16106		168	N154	145TTWD14002	✓	133	N283	056B17V5303	✓	130	N403A	143TTWD16039	✓	132
M900A	SEE M900B		168	N154A	145TTWD16009	✓	133	N284	056C34V5301	✓	130	N404	SEE N404A		132
M900B	286TFFNA16021		168	N155	SEE N155A		133	N285	056B17V5304	✓	130	N404A	145TTWD6026	✓	132
M901A	SEE M901B		168	N155A	145TTWD16037	✓	133	N286	056B34W5301	✓	130	N405	SEE N405A		132
M901B	286TFFNA16341		168	N156	145TTWD14003	✓	133	N287	145TBWD5329	✓	130	N405A	145TTWD6027	✓	132
M902A	SEE M902B		168	N156A	145TTWD16006	✓	133	N288	145TBWD5301	✓	130	N406	SEE N406A		132
M902B	326TFFS16377		168	N157	182TTWD14033	✓	133	N289	145TBWD5328	✓	130	N406A	182TTWD6031	✓	132
M904A	SEE M904B		168	N157A	182TTWD16027	✓	133	N291	056T17W5329	✓	132	N407	SEE N407A		132
M904B	324TFFS16011		168	N158	SEE N158A		133	N291A	056T17W99039	✓	132	N407A	184TTWD6031	✓	132
M905A	SEE M905B		168	N158A	184TTWD16003	✓	133	N292	143TTWD16031	✓	132	N408	SEE N408A		132
M905B	324TFFS6041		168	N159	184TTWD14033	✓	133	N293	056T17W5336	✓	132	N408A	213TTWD6031	✓	132
M906A	SEE M906B		168	N159A	184TTWD16033	✓	133	N293A	056T17W99029	✓	132	N408B	213TTWD6031	✓	132
M906B	364TFFS16087		168	N160	213TTWD14002	✓	133	N294	056T17W5337	✓	132	N409	SEE N409A		132
M907	SEE M907B		168	N160A	213TTWD16003	✓	133	N294A	056T17W99033	✓	132	N409A	215TTWD6031	✓	132
M907B	365TFFS16105		168	N161	213TTWD14032	✓	133	N309	SEE N326		122	N409B	215TTWD6031	✓	132
M908B	---		168	N161A	213TTWDD16026	✓	133	N310	SEE N310A		122	N410	056T17V5326	✓	129

Index

Catalog Number/Model Number

INDEX

CAT. NO.	MODEL NO.	STOCK	PAGE NO.	CAT. NO.	MODEL NO.	STOCK	PAGE NO.	CAT. NO.	MODEL NO.	STOCK	PAGE NO.	CAT. NO.	MODEL NO.	STOCK	PAGE NO.
N411	056T17VD5328	✓	129	N467	SEE N467A		131	N616	SEE N616B		124	N683	145TCWR5326	✓	121
N412	056T17VD5327	✓	129	N467A	143TTWD16036	✓	131	N616B	184TTWW6026	✓	124	N684	SEE N684A		121
N413	SEE N419A		129	N468A	056T17W5330	✓	131	N617	SEE N617A		124	N684A	182TCWW7026	✓	121
N414	SEE N414A		129	N468B	056T17W99028	✓	131	N617A	213TTWR6002	✓	124	N685	143TCWR17031	✓	121
N414A	143TTWD6026	✓	129	N469	145TTWD14034	✓	131	N617B	213TTWRD6002	✓	124	N701	048T17V11001	✓	135
N415	056T17WD5329	✓	129	N469A	145TTWD16034	✓	131	N618	SEE N618A		124	N703	056T34V99013	✓	135
N415A	056T17WD15329	✓	129	N470A	SEE N470B		131	N618A	213TTWR6026	✓	124	N704	048T17V11002	✓	135
N416	SEE N416A		129	N470B	056T17W99034	✓	131	N618B	213TTWRD6026	✓	124	N705	056T17V99016	✓	135
N416A	145TTWD6028	✓	129	N471	SEE N471A		131	N619	SEE N619A		124	N707	056T34V99014	✓	135
N417	056T17WD5328	✓	129	N471A	145TTWD16036	✓	131	N619A	215TTWR6026	✓	124	N708	056T17W99011	✓	135
N417A	056T17WD15328	✓	129	N480A	056T34V5316	✓	131	N619B	215TTWRD6026	✓	124	N710	056T34V99011	✓	135
N418	SEE N418A		129	N481A	056T34V5317	✓	131	N620	SEE N620A		124	N711	SEE N711A		135
N418A	145TTWD6029	✓	129	N482A	056T34V5313	✓	131	N620A	056T17V15501	✓	124	N711A	056T17W99036	✓	135
N419	SEE N419A		129	N483	SEE N483A		131	N621	056T17W5335	✓	124	N713	143TTWD16004	✓	135
N419A	056T17WD15336	✓	129	N483A	143TTWD16005	✓	131	N622	056T17V5337	✓	124	N715	056T17W99007	✓	135
N426	056T11VD5378	✓	128	N484	SEE N484A		131	N623	056T17W5339	✓	124	N715A	056T17W99045	✓	135
N427	056T11VD5379	✓	128	N484A	145TTWD16007	✓	131	N626	SEE N626A		124	N716	143TTWD16033	✓	135
N428	SEE N428A		128	N485	SEE N485A		131	N626A	143TTWR6028	✓	124	N718	145TTWD16004	✓	135
N428A	056T17WD15332	✓	128	N485A	145TTWD16008	✓	131	N627	056T17W5341	✓	124	N720	056T17W99009	✓	135
N429	056T11WD5379	✓	128	N486	184TTWD14002	✓	131	N627A	056T17W99035	✓	124	N720A	056T17W99032	✓	135
N430	056T17VD5329	✓	128	N486A	184TTWD16004	✓	131	N628	056T17W5334	✓	124	N721	145TTWD16032	✓	135
N431	056T17VD5330	✓	128	N494	056T17W5338	✓	129	N629	145TTWR5030	✓	124	N753	056T34V99012	✓	135
N432	056T17VD5331	✓	128	N495	056T11VD5385	✓	129	N629A	145TTWR16029	✓	124	N755	056T17V99015	✓	135
N433	SEE N433A		128	N496	056T17W5337	✓	129	N630	145TTWR6033	✓	124	N757	056T34V99015	✓	135
N433A	056T17WD15330	✓	128	N497	056T11W5386	✓	129	N631	056T34V99002	✓	124	N758	056T17V99014	✓	135
N434A	143TTWD4527	✓	128	N498	056T11W5387	✓	129	N632	056T17W99005	✓	124	N760	056T34V99016	✓	135
N434B	143TTWD6527	✓	128	N499	145TTWD6077	✓	129	N633	056T17W99004	✓	124	N761	056T17V99013	✓	135
N435	056T17W5331	✓	128	N523	056C17W5327	✓	121	N634	182TTWW16002	✓	124	N761A	056T17W99038	✓	135
N435A	056T17WD15331	✓	128	N524	056C34W5303	✓	121	N635	184TTWW16002	✓	124	N763	143TTWD16003	✓	135
N436	SEE N436A		128	N525	056C17W5328	✓	121	N637	215TTWW16003	✓	124	N765	056T17W99010	✓	135
N436A	145TTWD6031	✓	128	N526	056C34W5304	✓	121	N637A	215TTWW16003	✓	124	N765A	056T17W99030	✓	135
N437	056T17WD5332	✓	128	N527	056C17W5329	✓	121	N640	056T17V5326	✓	123	N766	143TTWD16032	✓	135
N437A	056T17WD15332	✓	128	N528	056C34W5305	✓	121	N641	056T17V5327	✓	123	N768	145TTWD16005	✓	135
N438A	SEE N438B		128	N529	056C17W5330	✓	121	N642	056T17V5328	✓	123	N770	056T17W99008	✓	135
N438B	145TTWD6528	✓	128	N530	056C34W5301	✓	121	N643	056T34V5301	✓	123	N770A	056T17W99031	✓	135
N439	SEE N439A		132	N531	056C17W5326	✓	121	N644	056T17V5329	✓	123	N771	145TTWD16031	✓	135
N439A	056T34V5314	✓	132	N532	056C34W5302	✓	121	N645	056T34V5302	✓	123	N1314	SEE N1314B		122
N440	SEE N440A		132	N540	056C34W5308	✓	121	N646	SEE N646A		123	N1315	SEE N1315A		122
N440A	056T34V5312	✓	132	N541	056C17W5333	✓	121	N646A	056T17W99015	✓	123	N1316	SEE N1316B		122
N441	SEE N441A		132	N542	056C34W5309	✓	121	N647	SEE N647A		123	N1317	SEE N1317A		122
N441A	056T34V5315	✓	132	N543	056C17W5334	✓	121	N647A	143TTWR16026	✓	123	N1614	SEE N1614B		124
N442	SEE N442A		132	N544	056C34W5310	✓	121	N648	056T34V5303	✓	123	N1615	SEE N1615B		124
N442A	143TTWD16002	✓	132	N545	056C17W5335	✓	121	N649	056T17V5331	✓	123	N1616	SEE N1616B		124
N443	SEE N443A		132	N546	056C34W99003	✓	121	N649A	056T17W99018	✓	123	N1656	SEE N1656B		123
N443A	145TTWD16003	✓	132	N556	056C34W5306	✓	121	N650	SEE N650A		123	N1657	SEE N657C		123
N444	145TTWD16002	✓	132	N557	056C17W5331	✓	121	N650A	143TTWR16030	✓	123	N1658	SEE N658C		123
N445	SEE N445A		132	N558	056C34W5307	✓	121	N651	SEE N651A		123	O002	048S17S25	✓	200
N445A	184TTWD16002	✓	132	N559	056C17W5332	✓	121	N651A	056T34V99020	✓	123	O003	048S17S24	✓	200
N446	SEE N446A		132	N564	056T17V5332	✓	124	N652	SEE N652A		123	O004	048S34S2003	✓	200
N446A	213TTWD16002	✓	132	N566	056T34V5305	✓	124	N652A	145TTWR16008	✓	123	O005	048S34S2004	✓	200
N447	SEE N447A		132	N567	056T17V5336	✓	124	N653	SEE N653A		123	O010	048C34D2024	✓	200
N447A	215TTWD16002	✓	132	N568	056T11V5376	✓	124	N653A	056T17W99022	✓	123	O011	048C34D2028	✓	200
N448A	SEE N448B		131	N569	056T34V5306	✓	124	N654	SEE N654B		123	O012	048C34S24	✓	200
N448B	182TTWD16026	✓	131	N599	056T17V5338	✓	124	N654B	145TTWR16028	✓	123	O013	048C34S2001	✓	200
N449A	SEE N449B		131	N600	056T11V5377	✓	124	N655A	145TTWR4301	✓	123	O014	SEE O010		200
N449B	184TTWD16032	✓	131	N601	056T34V5307	✓	124	N655B	145TTWR16005	✓	123	O100	048S34S361	✓	200
N450	056T34VD5301	✓	129	N602	SEE N602A		124	N656B	182TTWW4028	✓	123	O102	048S34S2005	✓	200
N451	056T34VD5302	✓	129	N602A	056T17W99016	✓	124	N656C	182TTWW16026	✓	123	O200	056S34D2000	✓	201
N452	056T34VD5303	✓	129	N604	056T11W5377	✓	124	N657B	184TTWW4002	✓	123	O201	056S34D93	✓	201
N453	056T34WD5301	✓	129	N604A	056T11W99003	✓	124	N657C	184TTWW16004	✓	123	O210	056C34D2114	✓	201
N454	SEE N454A		129	N605	056T34V5308	✓	124	N658B	SEE N658C		123	O211	056C34D2109	✓	201
N454A	143TTWD6001	✓	129	N606	056T17V5342	✓	124	N658C	184TTWW16026	✓	123	O212	056C34D2098	✓	201
N455	SEE N455A		129	N606A	056T17W99044	✓	124	N659A	213TTWR4001	✓	123	O213	056C34D2099	✓	201
N455A	056T34WD15302	✓	129	N607	145TTWR5326	✓	124	N659B	213TTWW16003	✓	123	O214	056C34D2104	✓	201
N456	143TTWD4002	✓	129	N607A	145TTWR16026	✓	124	N660	213TTWR7026	✓	123	O215	056C34D2112	✓	201
N456A	143TTWD6002	✓	129	N608	SEE N608A		124	N660A	213TTWW16028	✓	123	O217	056C34D2105	✓	201
N457	SEE N457A		129	N608A	182TTWW16087	✓	124	N661	SEE N661A		123	O231	056B34D2028	✓	201
N457A	056T34WD15303	✓	129	N609	SEE N609A		124	N661A	215TTWW16027	✓	123	O232	056B34D5337	✓	201
N458	SEE N458A		129	N609A	056T34W99022	✓	124	N662	SEE N662A		123	O600	048S17T286	✓	200
N458A	145TTWD6001	✓	129	N610	SEE N610A		124	N622A	056T34V99016	✓	123	O601	048S17T290	✓	200
N459	145TTWD6030	✓	129	N610A	145TTWR16003	✓	124	N663	215TTWW16002	✓	123	O701	048A34SU1001	✓	200
N460	048T17V2001	✓	131	N611	SEE N611A		124	N664	215TTWW14008	✓	123	OB1024ES	Century	✓	26
N461	048T17V2002	✓	131	N611A	056T17W99020	✓	124	N664A	215TTWW16006	✓	123	OB1104AV1ES	Century	✓	26
N462A	056T17V5353	✓	131	N612	SEE N612A		124	N665	056T34V99001	✓	123	OB1104AV2ES	Century	✓	26
N463A	056T17V5352	✓	131	N612A	145TTWR6026	✓	124	N666	056T17W99003	✓	123	OB1204ALES	Century	✓	26
N464A	SEE N464B		131	N613	SEE N613A		124	N667	056T34V99002	✓	123	OB2024	Century	✓	189
N464B	056T17W99037	✓	131	N613A	145TTWR6001	✓	124	N668	056T17W99006	✓	123	OB2024L	Century	✓	189
N465A	056T17W5331	✓	131	N614	SEE N614B		124	N669	056T17W99002	✓	123	OB3075ES	Century	✓	44
N465B	056T17W99040	✓	131	N614B	182TTWW6026	✓	124	N680	056C17W5337	✓	121	OB3104ES	Century	✓	44
N466	143TTVD5327	✓	131	N615	SEE N615B		124	N681	056C17W5336	✓	121	OB3154ES	Century	✓	44
N466A	143TTWD16037	✓	131	N6											

CAT. NO.	MODEL NO.	STOCK	PAGE NO.	CAT. NO.	MODEL NO.	STOCK	PAGE NO.	CAT. NO.	MODEL NO.	STOCK	PAGE NO.	CAT. NO.	MODEL NO.	STOCK	PAGE NO.
OB3204V1	Century	✓	44	R309	071T34FH5302	✓	104	R351A	100LTC6501	✓	105	R422A	100LTC6527	✓	105
OL1052DS	Century	✓	202	R310	080T17FH5326	✓	104	R352	SEE R352A		105	R424	SEE R424A		105
OL1072D	Century	✓	202	R311	080T11FH5378	✓	104	R352A	100LTC6536	✓	105	R424A	112MTFC6512	✓	105
OL2032	Century	✓	202	R312	080T34FH5301	✓	104	R353	SEE R353A		105	R425	SEE R425A		105
OL2034	Century	✓	202	R312A	080T34FH15301	✓	104	R353A	132STFC6586	✓	105	R425A	112MTFC6537	✓	105
OL2052D	Century	✓	202	R313	SEE R313A		104	R360	063T34FH5401	✓	106	R427A	132STFC6503	✓	105
OS2031L	Century	✓	189	R313A	080T17FH15327	✓	104	R361	063T17FH5402	✓	106	R428	SEE R428A		105
OS2050	Century	✓	189	R314	SEE R314A		104	R362	071T11FH5403	✓	106	R428A	132STFC6527	✓	105
OS2074	Century	✓	189	R314A	090ST11FH6376	✓	104	R363	063T34FH5404	✓	106	R430A	132STFC6504	✓	105
OBK6002V1	Century	✓	202	R315	080T34FH5302	✓	104	R364	071T17FH5405	✓	106	R431	SEE R431A		105
OKR1503	Century	✓	180	R316	SEE R316A		104	R365	080T11FH5406	✓	106	R431A	132MTFC6537	✓	105
OTEB2054A	Century	✓	181	R316A	090ST17FH6326	✓	104	R366	071T34FH5407	✓	106	R451	SEE R451A		105
P001	SEE KG215		46,140,201	R317	100LTC6586	✓	104	R367	071T17FH5408	✓	106	R451A	100LTC6502	✓	105
P002	SEE K216		46,140,201	R318	SEE R318A		105	R368	080T11FH5409	✓	106	R452	SEE R452A		105
P003	SEE K218		46,140,201	R318A	090ST34FH6301	✓	105	R369	071T34FH5410	✓	106	R452A	100LTC6537	✓	105
P004	SEE K220		46,140,201	R319	SEE R319A		105	R370	080T17FH5411	✓	106	R500	225MTFC6501	✓	105
P005	SEE K222		46,140,201	R319A	090LT17FH6326	✓	105	R371	080T11FH5412	✓	106	R501	225MTFC6526	✓	105
P006	SEE K224		46,140,201	R320	SEE R320A		105	R372	080T34FH5413	✓	106	R502	280STFC6586	✓	105
P007	SEE K226		46,140,201	R320A	100LTC6576	✓	105	R372A	080T34FH15413	✓	106	R503	250MTFC6501	✓	105
P101	056T34T5306	✓	58,141	R321	SEE R321A		105	R373	080T17FH5414	✓	106	R504	250MTFC6526	✓	105
P102	056T34F5321	✓	58,141	R321A	090LT34FH6301	✓	105	R373A	080T17FH15414	✓	106	R505	280MTFC6588	✓	105
P103	056T34F5322	✓	58,141	R322	SEE R322A		105	R374	SEE R374A		106	R506	280STFC6501	✓	105
P104	SEE P104A		58,141	R322A	100LTC6526	✓	105	R374A	090ST11FH6415	✓	106	R507	280STFC6526	✓	105
P104A	056T34F99009	✓	58,141	R323	SEE R323A		105	R375	080T34FH5416	✓	106	R508	315STFC6588	✓	105
P105	SEE P105A		58,141	R323A	112MTFC6576	✓	105	R376	SEE R376A		106	R700	071T17V5326	✓	134
P105A	056T34F99032	✓	58,141	R324	SEE R324A		105	R376A	090ST17FH6417	✓	106	R701	080T17V5326	✓	134
P106	SEE P106A		59,141	R324A	112MTFC6511	✓	105	R377	SEE R377A		106	R702	071T17V5327	✓	134
P106A	056T34F15600	✓	59,141	R325	SEE R325A		105	R377A	090ST34FH6418	✓	106	R703	080T17V5331	✓	134
P107	SEE P107A		59,141	R325A	112MTFC6536	✓	105	R378	SEE R378A		106	R704	080T17W5326	✓	134
P107A	056T34F15591	✓	59,141	R326	SEE R326A		105	R378A	090LT17FH6419	✓	106	R705	SEE R705A		134
P180	5KCP49WN9813S	✓	175	R326A	132MTFC6586	✓	105	R379	SEE R379A		106	R705A	090LT17W6026	✓	134
P184	5KCP49UN9612S	✓	175	R327	SEE R327A		105	R379A	090LT34FH6420	✓	106	R706	090LT17W4027	✓	134
P185	5KCP49UN9614S	✓	175	R327A	132STFC6501	✓	105	R380	063T34FH5501	✓	106	R706A	090LT17W6027	✓	134
P190	5KCP49Z9N617T	✓	172	R327M2	Century		118	R381	063T17FH5502	✓	106	R707	090LT17W4028	✓	134
P192	SEE X446		177	R328	SEE R328A		105	R382	071T11FH5503	✓	106	R707A	090LT17W6028	✓	134
P193	5KCP39SNB480S	✓	177	R328A	132STFC6526	✓	105	R383	063T34FH5504	✓	106	R710	080T17V5327	✓	134
P194	5KCP39SNB481S	✓	177	R329	SEE R329A		105	R384	071T17FH5505	✓	106	R711	080T17V5333	✓	134
P195	5KCP39SNB482S	✓	177	R329A	132MTFC6587	✓	105	R385	080T11FH5506	✓	106	R712	080T17W5327	✓	134
P196	5KCP39TNB763T	✓	177	R330	SEE R330A		105	R386	071T34FH5507	✓	106	R720	071T17V5328	✓	134
P197	5KCP39UNB767T	✓	177	R330A	132STFC6502	✓	105	R387	071T17FH5508	✓	106	R721	080T17V5328	✓	134
P198	5KCP39UNB764T	✓	177	R331	SEE R331A		105	R388	080T11FH5509	✓	106	R722	071T17V5329	✓	134
P239	5KCP33GNA471S	✓	118	R331A	132MTFC6536	✓	105	R389	071T34FH5510	✓	106	R723	080T17V5329	✓	134
P240-(GE)	SEE PG240		204	R332	SEE R332A		105	R390	080T17FH5511	✓	106	R724	080T17W5328	✓	134
P241	5KCP36RNA491S	✓	204	R332A	160MTFC6586	✓	105	R391	080T11FH5512	✓	106	R730	080T17V5330	✓	134
P243	5KCP49RN9611S	✓	175	R333	SEE R333A		105	R392	080T34FH5513	✓	106	R731	080T17V5332	✓	134
P244	5KCP49UN9613S	✓	175	R333A	160MTFC6511	✓	105	R392A	080T34FH15513	✓	106	R732	080T17W5329	✓	134
P245	5KCP49PN9812S	✓	175	R334	SEE R334A		105	R393	SEE R393A		106	R1052	Century		143
P246	5KCP49UN9811S	✓	175	R334A	160MTFC6536	✓	105	R393A	080T17FH15514	✓	106	R1072	Century		143
P247	5KCP35NNA670T	✓	219	R335	SEE R335A		105	R394	SEE R394A		106	R1072ES	Century		143
P250	5KCP35KNB057S	✓	115	R335A	160LTC6588	✓	105	R394A	090ST11FH6515	✓	106	R1102	Century		143
P251	5KCP36NNB059S	✓	115	R336	SEE R336A		105	R395	080T34FH5516	✓	106	R1102ES	Century		143
P252-(GE)	SEE PG252		219	R336A	160MTFC6512	✓	105	R396	SEE R396A		106	R1152ES	Century		143
P253	5KCP36NNB671U	✓	219	R337	SEE R337A		105	R396A	090ST17FH6517	✓	106	R1202ES	Century		143
P254	5KCP35KNB650U	✓	219	R337A	160LTC6538	✓	105	R397	SEE R397A		106	RB1052L	Century		192
PD1050AV1	Century	✓	116	R338	SEE R338A		105	R397A	090ST34FH6518	✓	106	RB1054AV1	Century		192
PD6104AV2	Century	✓	116	R338A	180LTC6588	✓	105	R398	SEE R398A		106	RB1074A	Century		192
PD6104AV3	Century	✓	116	R339	SEE R339A		105	R398A	090LT17FH6519	✓	106	RB1104AV1	Century		193
PG240	5KCP35CNA490S	✓	204	R339A	160LTC6513	✓	105	R399	SEE R399A		106	RB1154AV1	Century		193
PG252	5KCP36NNB670U	✓	219	R340	SEE R340A		105	R399A	090LT34FH6520	✓	106	RB1204AV1	Century		193
Q1032	Century	✓	138	R340A	180MTFC6536	✓	105	R400	063T34FH5303	✓	105	RB2014	Century		188
Q1052	Century	✓	138	R341	SEE R341A		105	R401	063T17FH5327	✓	104	RB2024	Century		188
Q1072	Century	✓	138	R341A	200LTC6588	✓	105	R403	063T34FH5304	✓	104	RB2026	Century		188
Q1072ES	Century	✓	143	R342	SEE R342A		105	R404	071T17FH5330	✓	104	RB2026L	Century		188
Q1102	Century	✓	138	R342A	180MTFC6511	✓	105	R406	071T34FH5303	✓	104	RB2034	Century		188
Q1102ES	Century	✓	143	R343	SEE R343A		105	R407	071T17FH5331	✓	104	RB2034L	Century		188
Q1152	Century	✓	138	R343A	180LTC6538	✓	105	R409	071T34FH5304	✓	104	RB2036	Century		188
Q1152ES	Century	✓	143	R344	SEE R344A		105	R410	080T17FH5330	✓	104	RB2054DV2	Century		189
Q1202	Century	✓	138	R344A	200LTC6589	✓	105	R412	080T34FH5305	✓	104	RB2054DV3	Century		189
R155	Century	✓	170	R345	SEE R345A		105	R412A	080T34FH15305	✓	104	RB3104A	Century		197
R180	Century	✓	170	R345A	200LTC6511	✓	105	R413	080T17FH5331	✓	104	RB3154A	Century		197
R243M2	Century	✓	118	R346	SEE R346A		105	R413A	080T17FH15331	✓	104	RB3154AV1	Century		197
R244M2	Century	✓	118	R346A	200LTC6538	✓	105	R415	080T34FH5303	✓	104	RB3204	Century		197
R300	063T34FH5301	✓	104	R347	SEE R347A		105	R416	SEE R416A		104	RB3204A	Century		197
R301	063T17FH5326	✓	104	R347A	225MTFC6586	✓	105	R416A	090ST17FH6327	✓	104	RB3204AV1	Century		197
R302	071T11FH5376	✓	104	R348	SEE R348A		105	R418	SEE R418A		105	RS1024A	Century		192
R303	063T34FH5302	✓	104	R348A	200LTC6513	✓	105	R418A	090ST34FH6302	✓	105	RS1030B	Century		192
R304	071T17FH5326	✓	104	R349	SEE R349A		105	R419	SEE R419A		105	RS1034A	Century		192
R305	080T11FH5376	✓	104	R349A	225STFC6526	✓	105	R419A	090LT17FH6327	✓	105	RS1035A	Century		192
R306	071T34FH5301	✓	104	R350	SEE R350A		105	R420A	100LTC6577	✓	105	RS1050A	Century		192
R307	071T17FH5327	✓	104	R350A	250MTFC6586	✓	105	R421	SEE R421A		105	RS1051A	Century		192
R308	080T11FH5377	✓	104	R351	SEE R351A		105	R421A	090LT34FH6302	✓	105	RS1054AV1	Century		192

Index

Catalog Number/Model Number

INDEX

CAT. NO.	MODEL NO.	STOCK	PAGE NO.	CAT. NO.	MODEL NO.	STOCK	PAGE NO.	CAT. NO.	MODEL NO.	STOCK	PAGE NO.	CAT. NO.	MODEL NO.	STOCK	PAGE NO.
RS1070AV1	Century	✓	192	SP2050A	Century	✓	136	TE126	Century	✓	64	TE207	Century	✓	68
RS1074AL	Century	✓	192	SV2054BV2L	Century	✓	181	TE127	Century	✓	64	TE208	Century	✓	68
RS1104AV1	Century	✓	193	SV2104HL	Century	✓	181	TE128	Century	✓	64	TE209	Century	✓	68
RS2014	Century	✓	188	SV2104HV2	Century	✓	181	TE129	Century	✓	64	TE210	Century	✓	68
RS2014L	Century	✓	188	SV2104L	Century	✓	181	TE130	Century	✓	64	TE211	Century	✓	68
RS2026	Century	✓	188	SV2104V1L1	Century	✓	181	TE131	Century	✓	64	TO100	Century	✓	48
RBF1034A	Century	✓	192	SGF2034V4	Century	✓	188	TE132	Century	✓	64	TO101	Century	✓	48
S003	048S17D2089	✓	27	SGF2054AV2	Century	✓	189	TE133	Century	✓	64	TO102	Century	✓	48
S006	048S17D2090	✓	27	SGF2054HL	Century	✓	189	TE134	Century	✓	64	TO103	Century	✓	48
S010	048C17D2023	✓	27	SGK2054V1	Century	✓	189	TE135	Century	✓	64	TO104	Century	✓	48
S011	SEE S011A	✓	27	SVB2034	Century	✓	181	TE136	Century	✓	64	TO104A	Century	✓	48
S011A	048B17D11014	✓	27	SVB2034B	Century	✓	181	TE137	Century	✓	64	TO105	Century	✓	48
S012	056C17D2098	✓	27	SVB2054	Century	✓	181	TE138	Century	✓	64	TO106	Century	✓	48
S013	SEE S013A	✓	27	SVB2054H	Century	✓	181	TE139	Century	✓	64	TO107	Century	✓	48
S013A	056B17D11042	✓	27	SVB2074	Century	✓	181	TE140	Century	✓	64	TO108	Century	✓	48
S014	056C17D2054	✓	27	SVB2074BV1	Century	✓	181	TE141	Century	✓	64	TO109	Century	✓	48
S015	SEE S015A	✓	27	SVB2074H	Century	✓	181	TE142	Century	✓	64	TO109A	Century	✓	48
S015A	056B17DRR70007A1	✓	27	SY001	056PNRA10100	✓	99	TE143	Century	✓	64	TO110	Century	✓	48
S022	056S17D2046	✓	27	SY003	056PNRA10101	✓	99	TE144	Century	✓	64	TO111	Century	✓	48
S026	048S17D2113	✓	27	SY004	056PNRA10102	✓	99	TE145	Century	✓	64	TO112	Century	✓	48
S027	056S17D2066	✓	27	SY005	056PNRA10103	✓	99	TE146	Century	✓	64	TO113	Century	✓	48
S030	SEE S030A	✓	27	SY006	SEE SY006A	✓	99	TE147	Century	✓	65	TO114	Century	✓	48
S030A	048B17D11016	✓	27	SY006A	182TPNSB10237	✓	99	TE148	Century	✓	65	TO114A	Century	✓	48
S033	SEE S033A	✓	27	SY007	184TPFSA10095	✓	99	TE149	Century	✓	65	TO115	Century	✓	48
S033A	056B17D11028	✓	27	SY007A	184TPNSB10236	✓	99	TE150	Century	✓	65	TO115A	Century	✓	48
S036	SEE S036A	✓	27	SY008	213TPFSA10096	✓	99	TE151	Century	✓	65	TO116	Century	✓	48
S036A	056B17DRR70009A1	✓	27	SY008A	213TPNSB10234	✓	99	TE152	Century	✓	65	TO116A	Century	✓	48
S037	056C17D5319	✓	27	SY009	215TPFSA10097	✓	99	TE153	Century	✓	65	TO117	Century	✓	48
S038	SEE S038A	✓	27	SY009A	215TPNSB10235	✓	99	TE154	Century	✓	65	TO117A	Century	✓	48
S038A	056B17DRR70018A1	✓	27	SY010	254TPFSA10088	✓	99	TE155	Century	✓	65	TO118	Century	✓	48
S039	SEE S039A	✓	27	SY011	256TPFSA10087	✓	99	TE156	Century	✓	65	TO119	Century	✓	48
S039A	056B17DRR70020A1	✓	27	SY012	284TPFSA10112	✓	99	TE157	Century	✓	65	TO119A	Century	✓	48
S102	048S17D2042	✓	185	SY013	286TPFSA10090	✓	99	TE158	Century	✓	65	TO121	Century	✓	48
S103	048S17D2091	✓	185	SY035	056PFRA10161	✓	99	TE159	Century	✓	65	TO121A	Century	✓	48
S106	048S17D2093	✓	195	SY036	182TPFRB10181	✓	99	TE160	Century	✓	65	TO122	Century	✓	48
S110	048C17D2028	✓	190	SY066	182TPFRB10194	✓	99	TE161	Century	✓	65	TO122A	Century	✓	48
S111	048C17D2029	✓	190	SY067	184TPFRB10214	✓	99	TE162	Century	✓	65	TO123	Century	✓	48
S112	056C17D2097	✓	190	SY068	213TPFRB10230	✓	99	TE163	Century	✓	65	TO123A	Century	✓	48
S113	056C17D2099	✓	190	SY069	215TPFRB10219	✓	99	TE164	Century	✓	65	TO125	Century	✓	49
S114	056C17D2060	✓	191	TO10	056C17F5351	✓	225	TE165	Century	✓	65	TO125A	Century	✓	49
S115	056C17D2061	✓	191	TO13	056C34F5340	✓	225	TE166	Century	✓	65	TO126	Century	✓	49
S116	056C17D5339	✓	191	TO14	056C17F5350	✓	225	TE167	Century	✓	65	TO126A	Century	✓	49
S117	056C17D5340	✓	191	TO15	056C34F5339	✓	225	TE168	Century	✓	66	TO127	Century	✓	49
S118	048C17D2045	✓	190	TO16	056C17F5349	✓	225	TE169	Century	✓	66	TO127A	Century	✓	49
S119	048C17D2046	✓	190	TO17	056B34F5332	✓	225	TE170	Century	✓	66	TO128	Century	✓	49
S120	056S17D2023	✓	187	TO18	056B17F5328	✓	225	TE171	Century	✓	66	TO128A	Century	✓	49
S126	048S17D2104	✓	185	TO19	056B34F5333	✓	225	TE172	Century	✓	66	TO130	Century	✓	49
S127	048S17D2105	✓	195	TO30	056B17F5329	✓	225	TE173	Century	✓	66	TO130A	Century	✓	49
S128	048S17D2106	✓	187	TO31	145TBF85309	✓	225	TE174	Century	✓	66	TO131	Century	✓	49
S501	145TTN18577	✓	220	TI032	Century	✓	138	TE175	Century	✓	66	TO131A	Century	✓	49
S503	145TTN18531	✓	220	TI052	Century	✓	138	TE176	Century	✓	66	TO132	Century	✓	49
S504	184TTN18577	✓	220	TI072	Century	✓	138	TE177	Century	✓	66	TO132A	Century	✓	49
S506	182TTN18532	✓	220	TI102	Century	✓	138	TE178	Century	✓	66	TO133	Century	✓	49
S507	213TTN17077	✓	220	TI152	Century	✓	138	TE179	Century	✓	66	TO133A	Century	✓	49
S510	215TTN17077	✓	220	TI202	Century	✓	138	TE180	Century	✓	66	TO138	Century	✓	49
S513	254TTN17077	✓	220	TE100	Century	✓	63	TE181	Century	✓	66	TO138A	Century	✓	49
S516	256TTN18578	✓	220	TE101	Century	✓	63	TE182	Century	✓	66	TO139	Century	✓	49
S517	284TTN18601	✓	220	TE102	Century	✓	63	TE183	Century	✓	66	TO139RS	Century	✓	49
S518	254TTN18530	✓	220	TE103	Century	✓	63	TE184	Century	✓	67	TO144	Century	✓	49
S519	284TTN16577	✓	220	TE104	Century	✓	63	TE185	Century	✓	67	TO144RS	Century	✓	49
S520	286TTN18602	✓	220	TE105	Century	✓	63	TE186	Century	✓	67	TO149	Century	✓	49
S522	286TTN18577	✓	220	TE106	Century	✓	63	TE187	Century	✓	67	TO149RS	Century	✓	49
S523	324TTN18601	✓	220	TE107	Century	✓	63	TE188	Century	✓	67	TO154	Century	✓	50
S525	324TTN18577	✓	220	TE108	Century	✓	63	TE189	Century	✓	67	TO154RS	Century	✓	50
S528	326TTN18577	✓	220	TE109	Century	✓	63	TE190	Century	✓	67	TO155	Century	✓	50
S553	145TTN18532	✓	220	TE110	Century	✓	63	TE191	Century	✓	67	TO155RS	Century	✓	50
S554	184TTN18578	✓	220	TE111	Century	✓	63	TE192	Century	✓	67	TO156	Century	✓	50
S557	213TTN17078	✓	220	TE112	Century	✓	63	TE193	Century	✓	67	TO156RS	Century	✓	50
S560	215TTN17078	✓	220	TE113	Century	✓	63	TE194	Century	✓	67	TO157	Century	✓	50
S564	256TTN18601	✓	220	TE114	Century	✓	63	TE195	Century	✓	67	TO157RS	Century	✓	50
S566	256TTN18577	✓	220	TE115	Century	✓	63	TE196	Century	✓	67	TO158	Century	✓	50
S567	284TTN17101	✓	220	TE116	Century	✓	63	TE197	Century	✓	67	TO158RS	Century	✓	50
S569	284TTN18577	✓	220	TE117	Century	✓	63	TE198	Century	✓	67	TO159	Century	✓	50
SI202	E56Y22TFC2050	✓	98	TE118	Century	✓	63	TE199	Century	✓	68	TO159RS	Century	✓	50
SI203	E56Y22TFC2051	✓	98	TE119	Century	✓	63	TE200	Century	✓	68	TO160	Century	✓	50
SI204	E56Y22TFC2052	✓	98	TE120	Century	✓	63	TE201	Century	✓	68	TO160RS	Century	✓	50
SI402	E56Y42TFC2050	✓	98	TE121	Century	✓	63	TE202	Century	✓	68	TO161	Century	✓	50
SI403	E56Y42TFC2051	✓	98	TE122	Century	✓	63	TE203	Century	✓	68	TO161RS	Century	✓	50
SI404	E56Y42TFC2052	✓	98	TE123	Century	✓	63	TE204	Century	✓	68	TO162	Century	✓	50
SP2030A	Century	✓	136	TE124	Century	✓	63	TE205	Century	✓	68	TO162RS	Century	✓	50
SP2034A	Century	✓	136	TE125	Century	✓	63	TE206	Century	✓	68	TO163	Century	✓	50

CAT. NO.	MODEL NO.	STOCK	PAGE NO.	CAT. NO.	MODEL NO.	STOCK	PAGE NO.	CAT. NO.	MODEL NO.	STOCK	PAGE NO.	CAT. NO.	MODEL NO.	STOCK	PAGE NO.
T0163RS	Century	✓	50	U026B	215TTGND16532	✓	87	U081A	365TSTGS16532		88	U153	SEE GT2409		154
T0164	Century	✓	50	U027	SEE U027A		87	U082	SEE U082A		88	U154	SEE GT2509		154
T0165	Century	✓	50	U027A	254TTGN16541	✓	87	U082A	405TSTGS16531		88	U155	SEE GT4309		154
T0165RS	Century	✓	50	U028	SEE U028A		87	U083	SEE U083A		88	U156	SEE GT4409		154
T0166	Century	✓	50	U028A	256TTGN16540	✓	87	U083A	444TSTGN16531		88	U157	SEE GT4509		154
T0166RS	Century	✓	50	U029	SEE U029A		87	U084	SEE U084A		88	U158	SEE U158A		155
T0167	Century	✓	50	U029A	284TTGN16539	✓	87	U084A	445TSTGN16531		88	U158A	---		155
T0167RS	Century	✓	50	U030	SEE U030A		87	U085	SEE E582A		88	U159A	SEE GT2410		155
T0168	Century	✓	50	U030A	286TTGN16533	✓	87	U088	SEE E577		88	U160	SEE GT2510		155
T0168RS	Century	✓	50	U031	SEE U031A		87	U089	SEE E574		88	U161	SEE U161A		155
T0169	Century	✓	50	U031A	324TTGS16535	✓	87	U090	SEE U090A		88	U161A	---		155
T0169RS	Century	✓	50	U032	SEE U032A		88	U090A	445TTGN16588	✓	88	U162A	SEE U162B		155
T0170	Century	✓	50	U032A	326TTGS16539	✓	88	U091	SEE U091A		88	U162B	---		155
T0171	Century	✓	50	U033	SEE U033A		88	U091A	449TTGS16585		88	U163	SEE U163A		155
T0171RS	Century	✓	50	U033A	364TTGS16537	✓	88	U092	SEE E571		88	U163A	---		155
T0172	Century	✓	50	U034	SEE U034A		88	U093	SEE E573A		88	U164	SEE U164A		155
T0172RS	Century	✓	50	U034A	365TTGS16542	✓	88	U094	SEE E576A		88	U164A	---		155
T0173	Century	✓	50	U035	SEE U035A		88	U095	SEE E850A		88	U165	SEE GT2412		155
T0173RS	Century	✓	50	U035A	405TTGS16539	✓	88	U096	SEE E578		88	U165A	SEE GT2412		155
T0174	Century	✓	50	U036	SEE U036A		88	U097	SEE E594		88	U166	182TTDR4124		155
T0174RS	Century	✓	50	U036A	444TTGN16533	✓	88	U100	SEE U100A		149	U167	SEE U167A		155
T0175	Century	✓	50	U037	SEE U037A		88	U100A	---		149	U167A	---		155
T0175RS	Century	✓	50	U037A	445TTGN16544	✓	88	U101	SEE U101A		149	U168	182TTDR4113		155
T0176	Century	✓	51	U038	SEE U038A		88	U101A	---		149	U169	182TTDR4125		155
T0177	Century	✓	51	U038A	445TTGN16543	✓	88	U102	SEE U102A		149	U170	SEE U170A		155
T0178	Century	✓	51	U039	SEE U039A		86	U102A	---		149	U170A	---		155
T0179	Century	✓	51	U039A	145TTGN6576	✓	86	U103	SEE U103A		149	U171A	SEE GT2413		155
T0180	Century	✓	51	U040	SEE U040A		86	U103A	256TTDR16008	✓	149	U172	SEE GT2513		155
T0181	Century	✓	51	U040A	182TTGN6576	✓	86	U104	SEE U104A		149	U173	SEE U173A		155
T0181RS	Century	✓	51	U041	SEE U041A		86	U104A	---		149	U173A	---		155
T0182	Century	✓	51	U041A	184TTGN6576	✓	86	U105	SEE U105A		149	U175	SEE U175A		155
T0183	Century	✓	51	U042	SEE U042		86	U105A	284TTDN16059		149	U175A	---		155
T0184	Century	✓	51	U042A	213TTGN6576	✓	86	U106	SEE GT0465		149	U176	SEE U176A		155
T0185	Century	✓	51	U043	SEE U043B		86	U107	SEE GT0565		149	U176A	---		155
T0186	Century	✓	51	U043A	215TTGN6576	✓	86	U108	SEE U108A		149	U177A	SEE GT2415A		155
T0187	Century	✓	51	U043B	215TTGN6576	✓	86	U108A	284TTDN16009		149	U178	SEE GT2515A		155
T0188	Century	✓	51	U044	SEE E500		87	U109A	SEE GT0469		149	U179	SEE U179A		155
T0189	Century	✓	51	U045	SEE E501		87	U110	SEE GT0569		149	U179A	---		155
T0190	Century	✓	51	U046	SEE E504		87	U111	SEE U111A		149	U180	SEE U180A		155
T0191	Century	✓	51	U047	SEE E507		87	U111A	286TTDN16331		149	U180A	---		155
T0192	Century	✓	51	U048	SEE U048A		87	U112	SEE GT0467		149	U181	SEE U181A		155
T0193	Century	✓	51	U048A	324TTGS16577	✓	87	U113	SEE GT0567		149	U181A	---		155
T0194	Century	✓	51	U049	SEE E565		87	U114	SEE GT0472		149	U182	SEE U182A		155
T0195	Century	✓	51	U050	SEE E568A		87	U115	SEE GT0572		149	U182A	---		155
T0196	Century	✓	51	U055	SEE E583		88	U116	SEE GT0473		149	U183	SEE GT2416A		155
U001	SEE U001A		86	U058	SEE U058A		86	U118	SEE GT0476		149	U184	SEE GT2516A		155
U001A	143TTGN6526	✓	86	U058A	143TTGN6501	✓	86	U119	SEE GT0576		149	U185	SEE U185A		155
U002	SEE U002A		86	U059	SEE U059A		86	U120	SEE GT0477		149	U185A	213TTDWD16345		155
U002A	145TTGN6526	✓	86	U059A	145TTGN6501	✓	86	U121	SEE GT0577		149	U186A	SEE U186B		155
U003	SEE U003A		86	U060	SEE U060A		86	U122	SEE GT2301		154	U186B	---		155
U003A	145TTGN6527	✓	86	U060A	182TTGN6501	✓	86	U123A	SEE GT2401		154	U187	SEE U187A		155
U004	SEE U004A		86	U061	SEE U061A		86	U124	SEE GT2501		154	U187A	---		155
U004A	182TTGN6526	✓	86	U061A	184TTGN6501	✓	86	U125	SEE GT4301		154	U188	SEE U188A		155
U005	SEE U005A		86	U062A	213TTGN6501	✓	87	U126	SEE GT4401		154	U188A	---		155
U005A	184TTGN6526	✓	86	U062B	213TTGN6501	✓	87	U127	SEE GT4501		154	U189	SEE GT2418A		155
U006	SEE U006B		87	U063A	215TTGN6501	✓	87	U128	SEE GT2303		154	U189A	SEE GT2418A		155
U006A	213TTGN6526	✓	87	U063B	215TTGND6501	✓	87	U129	SEE GT2403		154	U190	SEE GT2518A		155
U006B	213TTGND6526	✓	87	U064	SEE E502		87	U129A	SEE GT2403		154	U191	SEE U191A		155
U007A	215TTGN6526	✓	87	U065	SEE E505		87	U130	SEE GT2503		154	U191A	---		155
U007B	215TTGND6526	✓	87	U066	SEE E546		87	U131	SEE GT4303		154	U192	SEE U192A		155
U008	SEE E503		87	U067	SEE E563		87	U132	SEE GT4403		154	U192A	---		155
U009	SEE E506		87	U068	SEE E566		87	U133	SEE GT4503		154	U193	SEE U193A		155
U010	SEE E547		87	U069	SEE E569		88	U134	SEE GT2304		154	U193A	---		155
U011	SEE E564		87	U070	SEE E572		88	U135A	SEE GT2404		154	U194	SEE U194A		156
U012	SEE E567		87	U071	SEE E575		88	U136	SEE GT2504		154	U194A	---		156
U013	SEE E570		88	U073	SEE U073A		88	U137	SEE GT4304		154	U195	SEE GT2419A		156
U018	SEE E585		88	U073A	444TSTGN16502		88	U138	SEE GT4404		154	U196	SEE GT2519A		156
U019	SEE E588		88	U074	SEE E584		88	U139	SEE GT4504		154	U197	SEE U197A		156
U020	SEE U020A		86	U075	SEE U075A		88	U140	SEE GT2306		154	U197A	---		156
U020A	143TTGN6530	✓	86	U075A	445TSTGN16506		88	U141	SEE GT2406		154	U198A	SEE U198B		156
U021	SEE U021A		86	U076	SEE U076A		87	U142	SEE GT2506		154	U198B	---		156
U021A	145TTGN6537	✓	86	U076A	284TSTGN16531		87	U143	SEE GT4306		154	U199	SEE U199A		156
U022	SEE U022A		86	U077	SEE U077A		87	U144	SEE GT4406		154	U199A	---		156
U022A	145TTGN6540	✓	86	U077A	286TSTGN16531		87	U145	SEE GT4506		154	U200	215TTDWD4011		156
U023	SEE U023A		86	U078	SEE U078A		87	U146	SEE GT2307		154	U201A	215TTDWD14020	✓	156
U023A	182TTGN6530	✓	86	U078A	324TSTGS16531		87	U147A	SEE GT2407		154	U201B	215TTDWD14020	✓	156
U024	SEE U024A		86	U079	SEE U079A		88	U148	SEE GT2507		154	U202	SEE GT2521A		156
U024A	184TTGN6530	✓	86	U079A	326TSTGS16532		88	U149	SEE GT4307		154	U203	SEE U203A		156
U025A	213TTGN16537	✓	87	U080	SEE U080A		88	U150A	SEE GT4407		154	U203A	---		156
U025B	213TTGND16537	✓	87	U080A	364TSTGS16531		88	U151	SEE GT4507		154	U204	215TTDWD4025		156
U026A	215TTGN16532	✓	87	U081	SEE U081A		88	U152	SEE GT2309		154	U205	SEE U205A		156

Index

Catalog Number/Model Number

INDEX

CAT. NO.	MODEL NO.	STOCK	PAGE NO.	CAT. NO.	MODEL NO.	STOCK	PAGE NO.	CAT. NO.	MODEL NO.	STOCK	PAGE NO.	CAT. NO.	MODEL NO.	STOCK	PAGE NO.
U205A	---		156	U284	215TDC6029	✓	42	U355A	---		152	U444	SEE U444A		47
U206	SEE U206A		156	U285	256TDC6079	✓	42	U356	SEE U356A		160	U444A	324TSDP16032		47
U206A	---		156	U286	215TDC6003	✓	42	U356A	---		160	U445	SEE U445A		47
U207	SEE U207A		156	U287	254TDC6029	✓	42	U357	SEE U357A		152	U445A	324TSDP16002	✓	47
U207A	254TDR16026	✓	156	U288	284TDC6079	✓	42	U357A	215TTFWD16013	✓	152	U446	SEE U446A		47
U208	SEE U208A		156	U289	254TDC6003	✓	42	U360	SEE U360A		151	U446A	326TSDR16035		47
U208A	---		156	U290	256TDC6029	✓	42	U360A	184TTFW16015	✓	151	U447	SEE U447A		47
U209	SEE U209A		156	U291	256TDC6003	✓	42	U363	SEE U363A		151	U447A	326TSDP16005		47
U209A	254TDX16055		156	U292	284TSDC6003	✓	42	U363A	145TFR16106	✓	151	U448	SEE U448A		47
U210	SEE U210A		156	U293	286TSDC6003	✓	42	U366	SEE GT2421A		156	U448A	365STDS16044		47
U210A	254TDR16028	✓	156	U294	324TSDC6003	✓	43	U400	SEE U400A		43	U449	SEE U449A		47
U211	SEE U211A		156	U299	SEE U299A		155	U400A	445TSDS16038	✓	43	U449A	365TSDS16008		47
U211A	---		156	U299A	---		155	U401A	145TDR16308	✓	47	U450	SEE U450A		47
U212	254TDX4014		156	U300	SEE GT3001		150	U402	SEE U402C		47	U450A	365TSDS6074		47
U213	254TDX4017	✓	156	U301	SEE GT3101		150	U402B	SEE U402C		47	U451	SEE U451A		47
U214	254TDX4008		156	U302	SEE GT3201		150	U402C	182TDDW16010	✓	47	U451A	365TSDS16005		47
U215	254TDX4010		156	U303	SEE GT3003		150	U403	SEE U403A		47	U452	SEE U452A		47
U216	254TDX4012		156	U304A	SEE GT3103		150	U403A	184TDDW16043		47	U452A	404TSDS6327		47
U217	254TDX4016		156	U305	SEE GT3203		150	U404	SEE U404B		47	U453	SEE U453A		47
U218	SEE U218A		156	U306	SEE GT3004		150	U404B	184TDDW16001	✓	47	U453A	404TSDS16006	✓	47
U218A	---		156	U307	SEE GT3104		150	U405	SEE U405A		47	U454A	405TSDS16039		47
U219	SEE U219A		156	U308	SEE GT3204		150	U405A	213TDDW16063	✓	47	U455	SEE U455A		47
U219A	256TDR16031	✓	156	U309	SEE GT3006		150	U405B	213TDDWD16063	✓	47	U455A	405TSDS16005		47
U220	SEE U220A		156	U310A	SEE GT3106		150	U409	SEE U409A		41	U456	SEE U456A		47
U220A	---		156	U311	SEE GT3206		150	U409B	182TDDW16328		41	U456A	444TSDS16034		47
U221	SEE U221A		156	U312	SEE GT3007		151	U410A	182TDDW16059	✓	47	U496	447TSDN16036	✓	43
U221A	---		156	U313A	SEE GT3107		151	U416	SEE U416A		39	U497	447TSDN16047	✓	43
U223	SEE U223A		156	U314	SEE GT3207		151	U416A	143TDR16035		39	U498	449TSDN16046	✓	43
U223A	---		156	U315	SEE U315A		151	U417	SEE U417A		39	U499	449TSDN16041		43
U224	SEE U224A		157	U315A	---		151	U417A	143TDR6052	✓	39	U500	256TDX4024		161
U224A	---		157	U316A	SEE GT3109		151	U418	SEE U418A		39	U500A	256TDBD4024	✓	161
U225	SEE U225A		157	U317	SEE GT3209		151	U418A	143TDR6051	✓	39	U501	256TDX4020		161
U225A	256TDR16004	✓	157	U319A	SEE GT3110		151	U419	SEE U419A		40	U501A	256TDBD4020	✓	161
U226	SEE U226A		157	U320	SEE GT3210		151	U419A	145TDR16441		40	U502	284TDP4027		161
U226A	---		157	U322A	SEE GT3112		151	U420	SEE U420A		40	U503	284TDP4047		161
U227	SEE U227A		157	U323	SEE GT3212		151	U420A	145TDR6126	✓	40	U504	284TSDP4002	✓	161
U227A	284TDR16060		157	U325A	SEE GT3113		151	U421	SEE U421A		40	U505	SEE U596		161
U228A	SEE GT2465		157	U326A	SEE GT3214A		151	U421A	145TDR6127		40	U506	286TDP4041		161
U229	SEE GT2565		157	U327	SEE U327A		151	U422	145TDR4134	✓	40	U507	286TDP14042		161
U230	SEE U230A		157	U327A	213TTFWD16014		151	U422A	145TDR16056	✓	40	U508	286TSDP4022	✓	161
U230A	284TDR16008		157	U328	SEE U328A		159	U423	SEE U423A		40	U509	286TSDP4023	✓	161
U231	SEE GT2469		157	U328A	---		159	U423A	145TDR6132	✓	40	U510	324TDP4038		161
U232	SEE GT2569		157	U329	SEE GT3115A		151	U424	SEE U424A		40	U510A	324TDCD4038	✓	161
U233	SEE U233A		157	U330	SEE GT3415A		159	U424A	145TDR6133	✓	40	U511	324TDP14049		161
U233A	286TDR16332		157	U331	SEE GT3215A		151	U425	SEE U425		41	U511A	324TDCD14049	✓	161
U234	SEE GT2467		157	U332	SEE GT3515A		159	U425B	182TDDW16048	✓	41	U512	324TSDP4010	✓	161
U235	SEE GT2567		157	U334	SEE GT3116A		151	U426	SEE U426B		41	U512A	324TSDCC4010	✓	161
U236	SEE GT2472		157	U335	SEE GT3216A		151	U426B	182TDDW16049	✓	41	U513	324TSDP4007	✓	161
U237	SEE GT2572		157	U336	SEE U336A		151	U427A	SEE U427B		41	U513A	324TSDCC4007	✓	161
U238	SEE GT2473		157	U336A	215TTFWD16011		151	U427B	184TDDW16326	✓	41	U514	326TDP4345		161
U239	SEE GT2573		157	U337	SEE GT3118A		151	U428A	SEE U428B		41	U514A	326TDCD4345	✓	161
U240	SEE GT2476		157	U338	SEE GT3218A		151	U428B	184TDDW16038	✓	41	U515	326TDP4344		161
U241	SEE GT2576		157	U339	SEE U339A		152	U429	SEE U429A		41	U515A	326TDCD4344	✓	161
U242	SEE GT2477		157	U339A	---		152	U429A	213TDDWD16349		41	U516	326TSDP4024	✓	162
U243	SEE GT2577		157	U340	SEE GT3119A		152	U430	SEE U430A		41	U516A	326TSDCC4024	✓	162
U244	056T34D6001	✓	39	U341	SEE GT3219A		152	U430A	213TDDW16060	✓	41	U517	326TSDP4020	✓	162
U245	143TDR6028	✓	40	U343	SEE U343A		160	U430B	213TDDWD16060	✓	41	U517A	326TSDCC4022	✓	162
U246	145TDR6039	✓	40	U343A	254TFL16009		160	U430A-P	213TDDW16075	✓	41	U518	364TSDS4332	✓	162
U247	145TDR6002	✓	41	U344	SEE U344A		152	U430B-P	213TDDWD16075	✓	41	U518A	364TSDCC4332	✓	162
U249A	184TDDW6001	✓	41	U344A	254TFL16008	✓	152	U431A-P	215TDDW16073	✓	41	U519	364TSDS4337		162
U250	404TSDS6001	✓	43	U345A	254TFL14008	✓	160	U431B-P	215TDDWD16073	✓	41	U519A	364TSDCC4337	✓	162
U251	405TSDS6007	✓	43	U345B	254TFL16010	✓	160	U432	SEE U432A		47	U520	364TDS4328		162
U252	444TSDS16003	✓	43	U346	SEE U346A		152	U432A	213TDDW16010		47	U521	326TSDR14034		162
U254	SEE GT0057		49	U346A	254TFL16011		152	U433	SEE U433A		47	U522	364TSDS4025	✓	162
U255	SEE GT0058		49	U347	SEE U347A		152	U433A	215TDDW16061		47	U522A	364TSDCC4025	✓	162
U256	284TDC6076	✓	42	U347A	---		152	U435	215TDDW4315		47	U523	364TSDS4024	✓	162
U257	286TDC6076		42	U348	SEE U348A		152	U436	SEE U436A		47	U523A	364TSDCC4024	✓	162
U265	145TDR6076	✓	40	U348A	254TFL16045		152	U436A	254TDR16056	✓	47	U524	365TSDS4332	✓	162
U268	213TDC6076	✓	41	U349	SEE U349A		152	U437	254TDX4315		47	U524A	365TSDCC4332	✓	162
U269	215TDC6076	✓	41	U349A	254TFL16043		152	U438	SEE U438A		47	U525	365TSDS4347		162
U270	404TDS6086	✓	43	U350	SEE U350A		152	U438A	256TDR16049		47	U525A	365TSDCC4347	✓	162
U271	405TSDS16081	✓	43	U350A	---		152	U439	SEE U439A		47	U526	365TSDS4025	✓	162
U272	444TSDS16077	✓	43	U351	256TFL4006	✓	152	U439A	256TDR16009		47	U526A	365TSDCC4025	✓	162
U273	445TSDS16076	✓	43	U351A	256TFL16004		152	U440	SEE U440A		47	U527	365TSDS4303	✓	162
U274	447TDR16077	✓	43	U352	SEE U352A		152	U440A	286TSDN16034		47	U527A	365TSDCC4303	✓	162
U275	449TDR16076	✓	43	U352A	---		152	U441	SEE U441A		47	U528	404TSDS4332	✓	162
U279	213TDC6079	✓	41	U353A	SEE U353B		152	U441A	286TSDN16005	✓	47	U528A	404TSDCC4332	✓	162
U280	215TDC6079	✓	41	U353B	256TFL16041		152	U442	SEE U442A		47	U529	404TSDS4333	✓	162
U281	213TDC6029	✓	41	U354	SEE U354A		152	U442A	286TSDN16033		47	U529A	404TSDCC4333	✓	162
U282	254TDC6079	✓	41	U354A	256TFL16042	✓	152	U443	SEE U443A		47	U530	404TSDS4017	✓	162
U283	213TDC6003	✓	41	U355	SEE U355A		152	U443A	286TSDN16004	✓	47	U530A	404TSDCC4017	✓	162

CAT. NO.	MODEL NO.	STOCK	PAGE NO.	CAT. NO.	MODEL NO.	STOCK	PAGE NO.	CAT. NO.	MODEL NO.	STOCK	PAGE NO.	CAT. NO.	MODEL NO.	STOCK	PAGE NO.
U531	404TSDS14008	✓	162	U644	SEE GT1021A		65	U758	143TDR6027	✓	40	U902A	286TSTDN16011		42
U531A	404TSTDCD14008	✓	162	U644A	SEE GT1021A		65	U758-P	143TDR16052	✓	40	U903	SEE U903A		43
U532	405TSDS4332	✓	162	U645	SEE E2146		55	U759	145TDR6028	✓	40	U903A	404TTDS16055		43
U532A	405TSTDCD4332	✓	162	U646A	SEE U646B		55	U759-P	145TDR16348	✓	40	U904	SEE U904A		43
U533	405TSDS4333	✓	162	U646B	254TFL16038	✓	55	U760	145TDR6029	✓	40	U904A	405TTDS16060		43
U533A	405TSTDCD4333	✓	162	U647A	SEE GT1022A		65	U760-P	145TDR16349	✓	40	U905	SEE U905A		40
U534	405TSDS4006	✓	162	U647B	254TFC6027	✓	55	U763	213TDC6026	✓	41	U905A	---		40
U534A	405TSTDCD4006	✓	162	U648A	SEE GT1122A		65	U764	213TDC6001	✓	41	U906	SEE U906A		40
U535	444TSDS4332	✓	162	U649	SEE U649A		56	U765	215TDC6026	✓	41	U906A	145TDR16008	✓	40
U535A	444TSTDCD4332	✓	162	U649A	256TFC6002	✓	56	U766	215TDC6001	✓	42	U907	SEE U907A		41
U536	444TSDS4010	✓	162	U650A	SEE GT1124A		65	U767	254TDC6026	✓	42	U907A	213TTDWD16086	✓	41
U536A	444TSTDCD4010	✓	162	U651	SEE U651A		56	U768	254TDC6001	✓	42	U908	SEE U908A		41
U537	445TSDS4332	✓	162	U651A	256TFL16039		56	U769	256TDC6026	✓	42	U908A	182TTDWD16008	✓	41
U537A	445TSTDCD4332	✓	162	U652	SEE U652B		56	U770	SEE GT0064		49	U909	SEE U909A		43
U538	364TTDS14329	✓	162	U652B	256TFC6027	✓	56	U771	284TDC6026	✓	42	U909A	324TSDP16009		43
U539	445TSDS14007	✓	163	U653A	SEE GT1125A		65	U772	SEE GT0069		49	U910	SEE U910A		43
U539A	445TSTDCD4007	✓	163	U654A	SEE GT1127A		65	U773	286TDC6026		42	U910A	326TSDP16014		43
U540	445TSDS14051	✓	163	U655	284TTPA4028	✓	56	U774	SEE GT0072		50	U911	SEE U911A		43
U540A	445TSTDCD14051	✓	163	U655A	284TTFNA16129		56	U775	SEE GT0073		50	U911A	444TTDS16043		43
U592	286TSTDBD4022	✓	161	U659A	SEE GT1137A		67	U775-P	324TTDR16050	✓	42	U912	SEE U912A		43
U593	286TSTDBD4023	✓	161	U660A	SEE GT1140A		67	U776	SEE GT0076		50	U912A	445TTDS16041		43
U594	286TTDDBD4041	✓	161	U661	SEE E314		57	U777	326TDC6026	✓	43	U914	182TTDWD16009	✓	40
U595	286TTDDBD14042	✓	161	U662	SEE E316A		57	U778	SEE GT0080		50	U915	184TTDWD16076	✓	40
U596	284TSTDBD4007	✓	161	U663	SEE E246		57	U785	447TSTDN16004	✓	43	U917	184TTDWD16041		41
U597	284TSTDBD4002	✓	161	U667	SEE E326		57	U786	447TDDN16046	✓	43	U922	SEE U922A		40
U598	284TTDDBD4027	✓	161	U669	SEE U669A		57	U788	447TSTDN16007	✓	43	U922A	143TDR16036		40
U599	284TTDDBD4047	✓	161	U669A	445TTFN6028		57	U789	447TDDN16041		43	U923	SEE U923A		40
U601	SEE U601A		53	U670	SEE E2121		55	U790	449TDDN16077		43	U923A	145TDR16054		40
U601A	145TTTN16045		53	U671	SEE GT1115A		64	U791	447TSTDN16008	✓	43	U924	SEE U924A		40
U602A	SEE GT1009A		63	U671A	213TFC6006	✓	55	U793	449TSTDN16003	✓	43	U924A	145TDR16059		40
U603	SEE E2134		54	U672	SEE U672A		53	U794	447TDDN16048		43	U925	SEE U925A		41
U604A	SEE GT1109A		64	U672A	---		53	U795	449TSTDN16004	✓	43	U925A	182TTDWD16082		41
U605A	SEE E2160		54	U699	145TTFN16082	✓	53	U796	449TSTDN16040		43	U926	SEE U926A		41
U606	SEE U606A		54	U701	SEE GT1201		70	U797	449TSTDN16005	✓	43	U926A	213TTDWD16061		41
U606A	145TTTN16039		54	U703	SEE U703A		61	U798	324TDC6076		42	U930	SEE U001A		86
U607A	SEE GT1010A		64	U703A	---		61	U799	326TDC6076		42	U931	SEE U039A		86
U608	SEE E2135		54	U704	SEE GT1204		70	U815	SEE GT1224A		72	U933	SEE U002A		86
U609	SEE U609A		54	U705	SEE GT1404		70	U830	SEE GT1233A		72	U934	SEE U040A		86
U609A	182TFC6031	✓	54	U706	SEE U706A		61	U834	SEE GT1236A		72	U935	SEE U059A		86
U610A	SEE GT1011A		64	U706A	---		61	U838	SEE GT1239A		72	U936	SEE U003A		86
U611	SEE E2162		54	U707	SEE GT1207		70	U842	SEE GT1242A		72	U937	SEE U041A		86
U613A	SEE GT1012A		64	U708	SEE GT1407		70	U845	SEE GT1245A		72	U938	SEE U060A		86
U614	SEE E2137		54	U710	SEE GT1210A		70	U867	SEE U867A		73	U939	SEE U004A		86
U615A	SEE GT1112A		64	U713	SEE GT1213A		70	U867A	182TTFN6557		73	U940	SEE U042A		86
U616A	SEE E2163		54	U716	SEE GT1216A		71	U868	SEE U868A		73	U941	SEE U061A		86
U618	SEE U618A		54	U718	SEE U718A		61	U868A	184TTFN6555	✓	73	U942	SEE U005A		86
U618A	184TFC6027	✓	54	U718A	---		61	U869	SEE U869A		73	U943	SEE U043B		86
U619	SEE E2138		54	U721	SEE U721A		61	U869A	213TTFN6550	✓	73	U944	SEE U062B		87
U620A	SEE GT1113A		64	U721A	254TFL16041		61	U870	SEE U870A		73	U945	SEE U006B		87
U621	SEE U621A		54	U722	SEE U722A		61	U870A	215TTFN6546	✓	73	U946	SEE E500		87
U621A	215TFC6077	✓	54	U722A	---		61	U870B	215TTFN6546	✓	73	U947	SEE U063B		87
U622	SEE U622A		55	U723	SEE U723A		61	U871	SEE U871A		73	U948	SEE U007B		87
U622A	213TTFW16011		55	U723A	254TFL16032		61	U871A	254TTFNA16568	✓	73	U949	SEE E501		87
U624A	SEE GT1015A		64	U724	SEE GT1225A		71	U872	SEE U872A		73	U950	SEE E502		87
U625	SEE E2140		55	U725	SEE GT1228A		71	U872A	256TTFNA16574	✓	73	U951	SEE E503		87
U627	SEE U627A		55	U726	SEE GT1231A		72	U873	SEE U873A		73	U952	SEE E504		87
U627A	213TTFW16048	✓	55	U727	SEE GT1234A		72	U873A	284TTFNA16832	✓	73	U953	SEE E505		87
U629	SEE GT1016A		64	U728	SEE GT1237A		72	U874	SEE U874A		73	U954	SEE E506		87
U629A	213TFC6027	✓	55	U729	SEE GT1240A		72	U874A	286TTFNA16572	✓	73	U955	SEE E507		87
U630	SEE E2141		55	U730	SEE GT1243A		72	U875	SEE U875A		73	U956	SEE E546		87
U631A	SEE GT1116A		64	U731	SEE GT1246A		72	U875A	324TTFN16837	✓	73	U957	SEE E547		87
U632	SEE E2117		55	U733	SEE GT1203		70	U876	SEE U876A		73	U958	SEE U048A		87
U633	SEE GT1017A		64	U735	SEE GT1206		70	U876A	326TTFN16574	✓	73	U959	SEE E563		87
U633A	254TFC6077	✓	55	U736	SEE U736A		61	U877	SEE U877A		73	U960	SEE E564		87
U634	SEE U634A		55	U736A	---		61	U877A	364TTFN16558	✓	73	U961	SEE E565		87
U634A	---		55	U737	SEE GT1209A		70	U878	SEE U878A		73	U962	SEE E566		87
U636	SEE U636A		55	U738	SEE U738A		61	U878A	365TTFN16827	✓	73	U963	SEE E567		87
U636A	215TFC6002	✓	55	U738A	---		61	U879	SEE U879A		73	U964	SEE E568A		87
U637	215TTFN4005		55	U739	SEE GT1212A		70	U879A	405TTFN16834	✓	73	U965	SEE E569		88
U637A	SEE GT1118A		64	U740	SEE U740A		61	U880	SEE U880A		73	U966	SEE E570		88
U638	SEE GT1121A		65	U740A	---		61	U880A	444TTFN16549	✓	73	U967	SEE E571		88
U638A	254TFC6006	✓	55	U741	SEE GT1215A		71	U881	SEE U881A		73	U968	SEE E572		88
U639	SEE U639A		55	U742	SEE GT1415A		71	U881A	445TTFN16866		73	U969	SEE E573A		88
U639A	215TFC6027	✓	55	U743	SEE U743A		61	U882	SEE U882A		73	U970	SEE E574		88
U640	SEE E2144		55	U743A	215TTFWD16018		61	U882A	445TTFN16852		73	U971	SEE E575		88
U641	SEE E306		55	U744	SEE GT1218A		71	U884	SEE U884A		73	U972	SEE E576A		88
U641A	215TFC6031	✓	55	U746	SEE GT1221A		71	U884A	449TTFN36649		73	U973	SEE E577		88
U642	SEE U642A		55	U748	SEE GT1224A		71	U900	254TDX4018		42	U974	SEE E578		88
U642A	256TFC6077	✓	55	U749	SEE GT1227A		71	U901	284TSDP4004		42	U975	SEE E594		88
U643	SEE U643A		55	U750	SEE GT1230A		72	U901A	284TSTDN16003		42	U976	SEE E580A		88
U643A	254TFL16006		55	U757	SEE GT1220A		72	U902	SEE U902A		42	U977	SEE U073A		88

Index

Catalog Number/Model Number

INDEX

CAT. NO.	MODEL NO.	STOCK	PAGE NO.	CAT. NO.	MODEL NO.	STOCK	PAGE NO.	CAT. NO.	MODEL NO.	STOCK	PAGE NO.	CAT. NO.	MODEL NO.	STOCK	PAGE NO.
U978	SEE E582A		88	U1927	364TTDCA6086	✓	42	W549	284THFNA19084	✓	80	W626-P	449THFS19342	✓	82
U979	SEE E583		88	U1928	365TTDCA6086		43	W550	286THFNA19101	✓	80	W629	449THFS19091		82
U980	SEE E584		88	V100	Century	✓	26	W551	256THFNA9001	✓	80	W630	449THFS19079		82
U981	SEE E585		88	V101	Century	✓	26	W553	256THFNA9026	✓	80	W632	449THFS9027		82
U982	SEE U090A		88	V102	Century	✓	26	W553-P	256THFNA19056	✓	80	W634	449THFS9001		82
U984	SEE E588		88	V108	Century	✓	28	W554	256THFNA19033	✓	80	W635	449THFS9036		82
U985	SEE U091A		88	V1104BL	Century	✓	181	W555	286THFNA9076	✓	80	W636	444THFN19081		81
U986	SEE U986A		86	V1154B	Century	✓	181	W556	286THFNA19077	✓	80	W638	SEE W638A		79
U986A	143TTGN6532		86	V1204B	Century	✓	181	W558	284TSHFNA9001	✓	80	W638A	---		79
U987	SEE U987A		86	V200M2	Century	✓	26	W559	284TSHFNA9005	✓	80	W639	364THFS19077		81
U987A	145TTGN16532		86	V201M2	Century	✓	216	W560	284THFNA9026	✓	80	W640	365THFS19077		81
U988	SEE U988A		86	V201M2	Century	✓	26	W560-P	284THFNA19048	✓	80	W641	445THFN19033		81
U988A	145TTGN6550		86	V203M2	Century	✓	29	W561	284THFNA19033	✓	80	W642	445THFN19034	✓	82
U989	SEE U004A		86	V208M2	Century	✓	216	W562	324THFS9076	✓	80	W643	326THFS19078	✓	80
U989-P	182TTGN6541	✓	86	V209M2	Century	✓	26	W563	324THFS9080	✓	80	WD140DCF	Century	✓	248
U990	SEE U005A		86	V211M2	Century	✓	26,216	W565	286TSHFNA9001	✓	80	WD140DCOD	Century	✓	248
U990-P	184TTGN6544	✓	86	V211M2	Century	✓	216	W567	286THFNA9026	✓	80	WD140TCDR	Century	✓	239
U991A	213TTGN6540	✓	87	V303M2	Century	✓	26	W567-P	286THFNA19066	✓	80	WD140TCF	Century	✓	240
U991B	213TTGN6540	✓	87	V304M2	Century	✓	26	W568	286THFNA19033	✓	80	WD180CFC	Century	✓	248
U991A-P	213TTGN16548	✓	87	V305M2	Century	✓	26	W569	326THFS9076	✓	80	WD180CCOD	Century	✓	248
U991B-P	213TTGND16548	✓	87	V308M2	Century	✓	120	W571	324THFS9001	✓	81	WD180TCDR	Century	✓	239
U992A	215TTGN6539	✓	87	V310M2	Century	✓	26	W573	324THFS9026	✓	81	WD180TCFS	Century	✓	240
U992B	215TTGND6539	✓	87	V311M2	Century	✓	26	W573-P	324THFS19058	✓	81	WD210DCF	Century	✓	248
U992A-P	215TTGN16539	✓	87	VB2034	Century	✓	181	W574	324THFS19033	✓	81	WD210DCOD	Century	✓	248
U992B-P	215TTGND16539	✓	87	VB2034B	Century	✓	181	W575	SEE W575A	✓	81	WD210TCDR	Century	✓	239
U1100	256TTDBD4008	✓	161	VB2054	Century	✓	181	W575A	364THFS19087	✓	81	WD210TCFS	Century	✓	240
U1101	284TTDBD4035	✓	161	VB2054B	Century	✓	181	W576	365THFS19101	✓	81	WD250DCF	Century	✓	248
U1103	284TSTDBD4008	✓	161	VB2074	Century	✓	181	W577	326TSHFS9001	✓	81	WD250CCF	Century	✓	241
U1104	286TTDBD4035	✓	161	VB2074B	Century	✓	181	W578	326TSHFS9005	✓	81	WD250TCFF2	Century	✓	241
U1106	286TSTDBD4008	✓	161	W501	143THTN9026	✓	79	W579	326TSHFS9036	✓	81	WD280DCF	Century	✓	248
U1107	324TTDCD4035	✓	161	W502	143THTN19033	✓	79	W580	326THFS9026	✓	81	WD280CCOD	Century	✓	248
U1109	324TSTDCD4008	✓	161	W503	SEE W503A		79	W580-P	326THFS19071	✓	81	WD280TCF3	Century	✓	241
U1110	326TTDCD4035	✓	161	W503A	---		79	W581	326THFS19033	✓	81	WD280TCF4	Century	✓	241
U1112	326TSTDCD4008	✓	162	W504	182THFS19101	✓	79	W582	SEE W582A	✓	81	WD280TCF	Century	✓	239
U1113	364TSTDCD4035	✓	162	W505	143THTN9001	✓	79	W582A	365THFS19086	✓	81	WD320DCF	Century	✓	248
U1115	364TSTDCD4008	✓	162	W506	143THTN9005	✓	79	W583	404THFS9101	✓	81	WD320CCOD	Century	✓	248
U1116	365TSTDCD4035	✓	162	W507	SEE W507A		79	W584	364TSHFS9001	✓	81	WD320TCF	Century	✓	241
U1118	365TSTDCD4008	✓	162	W507A	145THTN19059	✓	79	W586	364TSHFS9026	✓	81	WD320CCF2	Century	✓	241
U1119	404TSTDCD4035	✓	162	W508	SEE W508A		79	W587	364THFS9036	✓	81	WD320TCOD	Century	✓	239
U1121	404TSTDCD4008	✓	162	W508A	---		79	W587-P	364THFS19061	✓	81	WD320TCD2	Century	✓	239
U1122	405TSTDCD4035	✓	162	W509	182THS9076	✓	79	W588	364THFS19033	✓	81	WD360DCF	Century	✓	248
U1124	405TSTDCD4008	✓	162	W511	145THTN9001	✓	79	W589	404THFS9086	✓	81	WD360CCOD	Century	✓	248
U1125	444TSTDCD4035	✓	162	W512	145THTN19002	✓	79	W590	405THFS19101	✓	81	WD360TCF	Century	✓	241
U1127	444TSTDCD4008	✓	162	W513	SEE W513A		79	W591	365TSHFS9001	✓	81	WD360TCF2	Century	✓	241
U1128	445TSTDCD4035	✓	162	W513A	145THTN19058	✓	79	W592	365TSHFS19002	✓	81	WD360TCOD	Century	✓	239
U1130	445TSTDCD4008	✓	163	W514	SEE W514A		79	W593	SEE W593A	✓	81	WD360TCD2	Century	✓	239
U1131	445TSTDCD4036	✓	163	W514A	---		79	W593A	365TSHFS19034	✓	81	WD400DCF	Century	✓	248
U1248	182TTDW6001	✓	41	W515	184THS9076	✓	79	W594	365THFS9036	✓	81	WD400CCOD	Century	✓	248
U1266	182TTDW6076	✓	40	W517	182THS9001	✓	80	W594-P	365THFS19065	✓	81	WD400TCF	Century	✓	241
U1267	184TTDW6076	✓	40	W519	182THS9026	✓	80	W595	365THFS9044	✓	81	WD400TCD	Century	✓	240
U1402	SEE U402C		47	W520	182THS19033	✓	80	W596	405THFS9086	✓	81	WD400TCD2	Century	✓	240
U1404	SEE U404B		47	W521	213THFS9076	✓	80	W597	444THFS9101	✓	81	WD400TCF2	Century	✓	241
U1425	SEE U425B		41	W521A	213THFN9076	✓	80	W598	405TSHFS9001	✓	81	WD440DCF	Century	✓	248
U1426	SEE U426B		41	W522	215THFS9101	✓	80	W599	405TSHFS9026	✓	81	WD440CCOD	Century	✓	248
U1608	SEE E2135		54	W523	184THFS9001	✓	80	W600	405THFS9036	✓	81	WD440TCD	Century	✓	240
U1619	SEE E2138		54	W524	184THFS19006	✓	80	W600-P	405THFS19327	✓	81	WD440TCD2	Century	✓	240
U1647	SEE U647B		55	W525	184THFS9026	✓	80	W601	405THFS9040	✓	81	WD440TCF	Century	✓	241
U1652	SEE U652B		56	W526	184THFS9030	✓	80	W603	445THFN9106	✓	81	WD440TCF2	Century	✓	241
U1779	364TTDCA6060	✓	43	W527	215THFS9076	✓	80	W604	SEE W604A	✓	81	X000	048A1101798	✓	182
U1782	364TSTDCA6001		43	W528	215THFS19077	✓	80	W604A	444TSHFN19002	✓	81	X001	048A1101799	✓	182
U1783	365TTDCA6060		43	W529	254THFNA9101	✓	80	W606	444THFS9036	✓	81	X002	048A1101769	✓	182
U1784	365TSTDCA6001		43	W530	213THS9001	✓	80	W606-P	444THFN19044	✓	81	X003	048A1102042	✓	182
U1867	182TTN16571	✓	74	W531	213THS19005	✓	80	W607	444THFS9040	✓	81	X004	048A34SU1000	✓	182
U1868	184TTN16545	✓	74	W532	213THFS9026	✓	80	W608	445THFN9086	✓	81	X005	048A1101756	✓	182
U1869	213TTN16539	✓	74	W533	213THFS9030	✓	80	W609	445THFN9102	✓	81	X006	048A1102001	✓	182
U1869A	213TTND16539	✓	74	W533A	213THFN9030	✓	80	W610	445TSHFN9001	✓	81	X009	048A110787	✓	182
U1870	215TTN16541	✓	74	W534	254THFNA9076	✓	80	W611	445TSHFN9026	✓	81	X010	048A1102046	✓	182
U1870A	215TTND16541	✓	74	W536	256THFNA9101	✓	80	W612	445THFN9036	✓	81	X011	048A1702005	✓	172,182
U1871	254TTNA16545	✓	74	W537	215THFS9001	✓	80	W612-P	445THFN19071	✓	81	X012	048A1702006	✓	172,182
U1872	256TTNA16544	✓	74	W538	215THFS19006	✓	80	W613	445THFN9037	✓	81	X013	048A170152	✓	182
U1873	284TTNA16540	✓	74	W539	215THFS9026	✓	80	W614	445THFN9087	✓	81	X014	048A170154	✓	182
U1874	286TTNA16541	✓	74	W540	215THFS19033	✓	80	W615	449THFS9101	✓	81	X015	048A170151	✓	182
U1875	324TTS16535	✓	74	W540A	215THFN19033	✓	80	W616	445TSHFN9005	✓	82	X016	048A170153	✓	182
U1876	326TTS16533	✓	74	W541	256THFNA9076	✓	80	W617	445TSHFN9028	✓	82	X017	048A170155	✓	182
U1877	364TTS16534	✓	74	W542	256THFNA19081	✓	80	W618	445THFN9038	✓	82	X018	048A1101350	✓	182
U1878	365TTS16536	✓	74	W543	284THFNA19102	✓	80	W618-P	445THFN19070	✓	82	X019	048A1101351	✓	182
U1879	405TTS16537	✓	74	W544	254THFNA9001	✓	80	W619	449THFS9030	✓	82	X020	048A1101352	✓	182
U1880	444TTN16535	✓	74	W546	254THFNA9026	✓	80	W621	449THFS19092	✓	82	X021	048A1101353	✓	182
U1881	445TTN16536	✓	74	W546-P	254THFNA19065	✓	80	W622	449THFS9088	✓	82	X022	048A170174	✓	182
U1882	445TTN16537	✓	74	W547	254THFNA9030	✓	80	W624	449TSHFS9003	✓	82	X023	048A1101583	✓	182
U1884	449TTS16539	✓	74	W548	284THFNA9076	✓	80	W626	449THFS9028	✓	82	X024	048A172002	✓	114

CAT. NO.	MODEL NO.	STOCK	PAGE NO.	CAT. NO.	MODEL NO.	STOCK	PAGE NO.	CAT. NO.	MODEL NO.	STOCK	PAGE NO.	CAT. NO.	MODEL NO.	STOCK	PAGE NO.
X025	048A17T2003	✓	114	X236	048A110699	✓		X473	048A1101046	✓	183	Y219	505UTDS1584		221
X026	048A17T2004	✓	114	182,207,211				X474	048A1101047	✓	183	Y220	505UTDS1590		221
X027	048A11T2021	✓	114	X237	048A110694		182,207	X475	048A170123	✓	183	Y250	---		90
X028	048A11T2022	✓	114	X241	048A110697	✓	182,207	X476	048A170124	✓	183	Y251	---		90
X029	048A11T2023	✓	114	X242	048A110756	✓	182,207	X477	048A170128	✓	183	Y252	---		90
X030	048A17T118	✓	114	X251	056T34D5364	✓	196,208	X500	056T1105300	✓	179	Y253	---		90
X031	048A17T237	✓	114	X258	048A1101167	✓	184	X500-P	056T11015575	✓	179	Y254	---		90
X032	048A17T119	✓	114	X259	056T1101015	✓	210	X501	056T1105301	✓	179	Y255	---		90
X033	048A1101674	✓	182,211	X260	048A110251	✓	209	X501-P	056T11015574	✓	179	Y256	---		90
X034	048A1101773	✓	183	X261	048A80151	✓	209	X502	056T1105302	✓	179	Y257	---		90
X035	048A1101774	✓	183	X262	048A110245	✓	203	X502-P	056T11015571	✓	179	Y258	---		90
X036	048A1101772	✓	183	X263	048A11011041		203	X503	056T1105303	✓	179	Y259	---		90
X037	048A1101876	✓	183	X264	048A11011040		203	X503-P	056T11015570	✓	179	Y260	---		90
X038	048A1101874	✓	183	X268	048A1101239	✓	203,213	X506	056T805301		179	Y261	---		90
X039	048A1101875	✓	183	X269	048A170147	✓	203,210	X506-P	056T8015531	✓	179	Y262	---		90
X040	048A17069	✓	184	X270	048A170149	✓	203,212	X507	056T805302	✓	179,203	Y263	---		90
X041	048A17070	✓	184	X271	056A1105305	✓	175	X507-P	056T8015532	✓	179	Y270	SEE Y270A		92
X042	048A110653	✓	184	X273	048A170161	✓	207	X509	056T1105304	✓	179	Y270A	182THFW7730		92
X043	048A110654	✓	184	X278	048A80206	✓	173,211	X511	056T805303	✓	179	Y280	056H17T15526	✓	92
X044	048A110655	✓	184	X295	048A1101410		213	X512	056T11015511		178	Y281	056H17T15528	✓	92
X045	048A110656	✓	184	X297	048A111509	✓	173,211	X512-P	056T11015572	✓	178	Y282	056H17T15527	✓	92
X048	048A110772	✓	184	X298	048A1102059	✓	172	X513	056T1105305	✓	178	Y283	143THTR15535	✓	92
X049	048A110773	✓	184	X301	048A17T72	✓	204	X513-P	056T11015573	✓	178	Y284	145THTR15540	✓	92
X050	048A110774	✓	184	X302	048A111199	✓	204	X522	056T1105308	✓	179	Y285	145THTR17034	✓	92
X052	048A110775	✓	184	X303	048A111198	✓	204	X523	056T1105306	✓	178,203	Y286	SEE Y286A		92
X056	048A110901	✓	184	X304	048A11T201	✓	204	X523-P	056T11015569	✓	178	Y286A	182THTY17041	✓	92
X057	048A110900	✓	184	X305	048A17T2001	✓	204	X524	056T1105307	✓	179	Y287	SEE Y287A		92
X058	048A1702001	✓	184	X400	048A1102017	✓	172	X525	056T1105310	✓	178,203	Y287A	184THTY17038	✓	92
X059	048A1702002	✓	184	X405	048A1101744	✓	207	X526	056T1105309	✓	179	Y302	SEE Y302A		118
X060	048A1702003	✓	184	X411	048A11T2008	✓	211	X527	056T805304	✓	179	Y302A	184TTDW7611	✓	118
X061	048A1102022	✓	184	X412	048A11T569	✓	174	X528	056T805306	✓	178,203	Y303	SEE Y1303		118
X062	048A1102009	✓	184	X413	048A11T529	✓	174	X528-P	056T8015529	✓	178	Y304	215TTDW7301	✓	118
X063	048A1102028	✓	184	X414	048A11T571	✓	174	X529	056T805531	✓	178,203	Y360	056H17T2017	✓	91
X064	048A1102011	✓	184	X415	048A11T2012	✓	174	X529-P	056T8015530	✓	178	Y361	056H17T2019	✓	91
X065	048A1102012	✓	184	X416	048A11T2013	✓	174	X530	056T805307	✓	179	Y362	056H17F2017	✓	91
X066	048A1102013	✓	184	X417	048A1102051	✓	182	X530-P	056T8015533	✓	179	Y363	056H17F2015	✓	91
X067	048A1102014	✓	184	X418	048A1102052	✓	182	X531	056T8015504	✓	178,203	Y364	056H17F2021	✓	91
X068	048A1102015	✓	184	X419	048A1102053	✓	182	X531-P	056T8015534	✓	178	Y365	056H17F2019	✓	91
X069	048A1702004	✓	184	X420	048A170169	✓	172	X532	056T11011001	✓	178	Y366	145THTR5329	✓	91
X070	048A1102024	✓	184	X422	048A170172	✓	172	X533	056T11011002	✓	178	Y367	145THTR5330	✓	91
X071	048A1102026	✓	184	X423	048A1102055	✓	172	X533-P	056T11011005	✓	178	Y368	145THFR5329	✓	91
X072	048A11T646	✓	205	X424	048A1102054	✓	172	X600	048C17D2057		210	Y369	145THFR5330	✓	91
X073	048A11011064	✓	206	X426	048A1101375	✓	172,203	X601	056C17D2101	✓	210	Y370	182THFR5329	✓	92
X074	048A11011042	✓	206	X427	048A11T2017	✓	174	X602	056C17D2102	✓	210	Y371	182THFR5330	✓	92
X075	048A11011063	✓	206	X428	SEE X412	✓	174	X603	056C17D5346	✓	210	Y372	SEE Y1372		92
X076	048A11T11006	✓	205	X429	048A11T2020	✓	174	X700	SEE 4722		204,212	Y373	SEE Y373A		92
X077	048A11011066	✓	206	X430	048A11T463	✓	174	X701	SEE 4404		204,212	Y373A	184THFW7736	✓	92
X080	SEE X081		172	X431	048A1101461	✓	174	X900	SEE H247		115	Y374	056H17T2018	✓	91
X081	048A1102031	✓	172	X432	056A11029	✓	173	X902	056B17F5324		113	Y375	056H17T2020	✓	91
X082	SEE X083		172	X433	056A11030	✓	173	X903	SEE X1903		115	Y376	056H17F2018	✓	91
X083	048A1102034	✓	172	X440	048A1102065	✓	173	X904	SEE X1904		115	Y377	056H17F2016	✓	91
X085	048A110678	✓	172	X441	048A1102062	✓	173	X905	SEE C1314		115	Y378	056H17F2022	✓	91
X086	048A802001	✓	172	X442	048A1102064	✓	173	X906	SEE C1315		115	Y379	056H17F2020	✓	91
X087	048A1102029	✓	172	X443	048A1102063	✓	173	X908	SEE C1909		115	Y380	184TTFS7290	✓	217
X088	048A1102032	✓	172	X444	048A1101596	✓	173	X909	048S17T2004	✓	117	Y381	213TFS7238	✓	217
X089	048A1102035	✓	172	X445	048A1101732	✓	177	X910	048S17T366	✓	117	Y382	215TFS7290	✓	217
X090	048A1102007	✓	172	X446	048A1101643	✓	177	X911	048S17T365	✓	117	Y383	254TTFNA7210	✓	217
X096	048A110840	✓	172	X447	048A1101642	✓	177	X912	056B17T5303	✓	113	Y384	256TTFNA7250	✓	217
X097	048A80182	✓	172	X448	056A1105314	✓	177	X913	056B17T20	✓	113	Y385	284TTFNA7240	✓	217
X098	048A80181	✓	172	X449	056A1105315	✓	177	X920	048A17T2005	✓	213	Y386	286TTFNA7260	✓	217
X099	048A1102016	✓	172	X450	048A8T71	✓	174	X921	048A17T2006	✓	213	Y387	324TFS7290	✓	217
X200	048A1101060	✓	212	X451	048A8T72	✓	174	X922	048A17T2007	✓	213	Y388	326TFS9210	✓	217
X203	048A1101062	✓	207	X452	048A8T73	✓	174	X923	048A11T2024	✓	213	Y389	364TFS9234	✓	217
X206	056A1105310	✓	175	X453	048A1101771	✓	172	X924	048A11T2025	✓	213	Y390	365TFS9230	✓	217
X207	056A1105311	✓	175	X454	048A170250	✓	172	X925	048A11T2026	✓	213	Y391	405TFS7297	✓	217
X208	056A805	✓	172	X455	048A1101770	✓	172	X1903	5KH32FNA499S	✓	115	Y392	444TFS7262	✓	217
X209	048A80183	✓	182,211	X456	048A11T578	✓	174	X1904	5KH33JNA500S	✓	115	Y393	286THNA7026	✓	94
X210	048A1101068	✓	207	X457	048A11T579	✓	174	XEL2014	Century		202	Y394	286THNA7036	✓	94
X211	048A170125	✓	182,208	X458	048A11T580	✓	174	Y201	215TTDW7376		221	Y395	284THFPA8086	✓	95
X212	048A1101065	✓	212	X459	048A11T581	✓	174	Y202	215TTDW7377	✓	221	Y409	SEE Y409A		218
X213	048A1101524	✓	172	X462	048A11T619	✓	174	Y203	254TDX7377	✓	221	Y409A	182TTDW7211	✓	218
X214	048A1101525	✓	172	X463	048A17T356	✓	174	Y204	256TDX7391	✓	221	Y412	SEE Y412A		218
X215	048A1101081	✓	212	X464	048A17T359	✓	174	Y209	365TDS7383	✓	221	Y412A	184TTDW7215	✓	218
X216	048A1101097	✓	173,211	X465	048A8T1002	✓	174	Y210	404TDS7387	✓	221	Y415	215TTDW7203	✓	218
X218	056A1105313	✓	212	X466	048A17T86	✓	174	Y211	405TDS7697	✓	221	Y418	254TDX7208	✓	218
X219	048A1102047	✓	182	X467	048A17T87	✓	174	Y212	444TDS8699	✓	221	Y449	145TDR5703	✓	218
X221	048A1101526	✓	172	X468	048A17T96	✓	174	Y213	445TDS9477	✓	221	Y450	145TDR5704	✓	218
X222	048A1101109	✓	207	X469	048A11T726	✓	174	Y215	284TDP7692	✓	221	Y451	145TDR5705	✓	218
X223	048A1102050	✓	207	X470	048A110885	✓	211	Y216	286TDP7689	✓	221	Y452	145TDR5706	✓	218
X230	048A170136	✓	203,209	X471	048A1101044	✓	183	Y217	324TDP7687	✓					

Index

Catalog Number/Model Number

INDEX

CAT. NO.	MODEL NO.	STOCK	PAGE NO.	CAT. NO.	MODEL NO.	STOCK	PAGE NO.	CAT. NO.	MODEL NO.	STOCK	PAGE NO.	CAT. NO.	MODEL NO.	STOCK	PAGE NO.
Y454A	184TTDW7286	✓	218	Y558	182THTL7736	✓	93	Y851A	444TFC6683	✓	215	Y996	215THFW7726	✓	92
Y455	215TTDW7204	✓	218	Y558A	182THTY7736	✓	93	Y853A	445TFC6683	✓	215	Y997	215THFW7736	✓	92
Y456	254TTDX7278	✓	218	Y559	SEE Y559A	✓	93	Y854A	447TFC6683	✓	215	Y998A	SEE Y1999	✓	92
Y457	256TTDX7263	✓	218	Y559A	184THY7736	✓	93	Y855A	SEE Y855B	✓	215	Y999	SEE Y1999	✓	92
Y458	256TTDX7264	✓	218	Y559	184THTL7736	✓	93	Y855B	449TFC6683	✓	215	Y1303	184TTDW7612	✓	118
Y459	284TDP7221	✓	218	Y560	213THTL7736	✓	93	Y856A	449TFS36633	✓	215	Y1372	184THFW7726	✓	92
Y460	286TTDP7217	✓	218	Y561	215THTL7736	✓	93	Y900	---	✓	90	Y1453	182TTDW7413	✓	218
Y465	145TDR5701	✓	218	Y562	254THTL5736	✓	93	Y901	---	✓	90	Y1484	182TTDW7412	✓	218
Y466	145TDR5702	✓	218	Y563	256THTNA7036	✓	94	Y902	---	✓	90	Y1487	184TTDW7209	✓	218
Y467	SEE Y467A	✓	218	Y564	184THS8028	✓	95	Y903	---	✓	90	Y1600	---	✓	164
Y467A	182TTDW7411	✓	218	Y565	213THTS8038	✓	95	Y904	---	✓	90	Y1601	---	✓	164
Y468	SEE Y468A	✓	218	Y566	215THTS8038	✓	95	Y905	---	✓	90	Y1602	---	✓	164
Y468A	184TTDW7230	✓	218	Y567	284THTNA7036	✓	94	Y906	---	✓	90	Y1603	---	✓	164
Y469	215TTDW7205	✓	218	Y569	284THFA8028	✓	95	Y907	---	✓	90	Y1604	---	✓	164
Y470	254TTDX7201	✓	218	Y570	286THFNA8028	✓	95	Y908	---	✓	90	Y1605	---	✓	164
Y471	256TTDX7253	✓	218	Y571	324THFA8028	✓	95	Y910	---	✓	90	Y1606	---	✓	164
Y472	284TDP7205	✓	218	Y572	326THFS8028	✓	95	Y911	---	✓	90	Y1607	---	✓	164
Y473	286TTDP7251	✓	218	Y573	364THFS8036	✓	95	Y912	---	✓	90	Y1608	254TTPFA14014	✓	164
Y485A	182TTDW7203	✓	218	Y574	365THFS8036	✓	95	Y913	---	✓	90	Y1609	254TTFNA14336	✓	164
Y486	SEE Y486A	✓	218	Y575	405THFS8036	✓	96	Y914	---	✓	90	Y1610	256TTFNA14022	✓	164
Y486A	184TTDW7287	✓	218	Y576	444THFN8036	✓	96	Y915	---	✓	90	Y1611	256TTFNA14071	✓	164
Y488	213TTDW7202	✓	218	Y577	445THFN8036	✓	96	Y916	---	✓	90	Y1612	284TSTFPA14007	✓	164
Y489	213TTDW7201	✓	218	Y578	445THFN8040	✓	96	Y917	---	✓	90	Y1613	284TTPFA14055	✓	164
Y490	215TTDW17206	✓	218	Y579	449THFS8036	✓	96	Y918	---	✓	90	Y1614	286TSTFPA14006	✓	164
Y491	215TTDW7201	✓	218	Y580	449THFS8037	✓	96	Y920	---	✓	90	Y1615	286TTFNA14050	✓	164
Y492	256TTDX7207	✓	218	Y582	286THFA8086	✓	95	Y921	---	✓	90	Y1616	324TSTFPA14010	✓	164
Y493	284TDP7202	✓	218	Y583	324THFA8086	✓	95	Y922	---	✓	90	Y1618	324TTPFA14071	✓	164
Y500	056H172011	✓	91	Y584	326THFA8086	✓	95	Y923	---	✓	90	Y1619	326TSTFPA14013	✓	164
Y501	056H172012	✓	91	Y585	364THFS8391	✓	95	Y924	---	✓	90	Y1621	326TTFNA14046	✓	164
Y502	056H172013	✓	91	Y586	365THFS8380	✓	95	Y925	---	✓	90	Y1622	364TSTFS14009	✓	164
Y503	056H172014	✓	91	Y587	404THFS8092	✓	95	Y926	---	✓	90	Y1624	364TTFNA14064	✓	164
Y504	056H172015	✓	91	Y588	405THFS8378	✓	95	Y927	---	✓	90	Y1625	365TSTFS14009	✓	164
Y505	056H172016	✓	91	Y589	444THFN8384	✓	96	Y928	---	✓	90	Y1627	365TSTFS14071	✓	164
Y506	056H172011	✓	91	Y590	145THTN8037	✓	95	Y929	---	✓	90	Y1628	405TSTFS14007	✓	164
Y507	056H172012	✓	91	Y592	056H172001	✓	93	Y930	---	✓	90	Y1630	405TTFNA14328	✓	164
Y508	056H172013	✓	91	Y595	213THFS8028	✓	95	Y931	---	✓	90	Y1631	---	✓	165
Y509	254THTNA8058	✓	95	Y596	215THFS8029	✓	95	Y932	---	✓	90	Y1632	---	✓	165
Y510	256THTNA8038	✓	95	Y597	254THFNA8038	✓	95	Y933	---	✓	90	Y1633	---	✓	165
Y511	284THFA8038	✓	95	Y598	256THFNA8038	✓	95	Y934	---	✓	90	Y1634	445STFNA14013	✓	165
Y512	286THFA8038	✓	95	Y600	056H17E5301	✓	94	Y935	---	✓	90	Y1635	445STFNA14067	✓	165
Y513	324THFA8038	✓	95	Y601	056H17E5302	✓	94	Y936	---	✓	90	Y1636	445TTFNA14337	✓	165
Y514	326THFA8038	✓	95	Y602	056H17E5303	✓	94	Y937	---	✓	90	Y1637	445STFNA14014	✓	165
Y515	364THFS8046	✓	95	Y603	056H17E5304	✓	94	Y938	---	✓	90	Y1638	445STFNA14066	✓	165
Y516	365THFS8046	✓	95	Y604	056H17E5305	✓	94	Y939	---	✓	90	Y1639	445TTFNA14338	✓	165
Y517	405THFS8046	✓	96	Y605	056H172021	✓	91	Y940	---	✓	90	Y1640	449TSTFS14012	✓	165
Y518	444THFN8046	✓	96	Y606	056H172022	✓	91	Y941	---	✓	90	Y1641	449TSTFS14040	✓	165
Y519	445THFN8046	✓	96	Y611	145THTR16031	✓	93	Y942	---	✓	90	Y1642	449TTFNA14055	✓	165
Y520	445THFN8050	✓	96	Y612	145THTR16032	✓	93	Y943	---	✓	90	Y1643	---	✓	165
Y521	056H172014	✓	91	Y621	SEE U501A	✓	161	Y944	---	✓	90	Y1644	449TSTFS14045	✓	165
Y522	145THTR5328	✓	91	Y623	SEE U599	✓	161	Y945	---	✓	90	Y1645	449TTFNA14057	✓	165
Y523	145THFR5326	✓	91	Y624	SEE U597	✓	161	Y946	---	✓	90	Y1646	---	✓	165
Y525	143THTN8028	✓	95	Y625	SEE U596	✓	161	Y947	---	✓	90	Y1647	449TSTFS14044	✓	165
Y526	145THTN8029	✓	95	Y627	SEE U595	✓	161	Y948	---	✓	90	Y1648	449TTFNA14056	✓	165
Y527	182THTS8028	✓	95	Y629	SEE U593	✓	161	Y949	---	✓	90	Y1649	---	✓	165
Y530	SEE Y370	✓	92	Y631	SEE U511A	✓	161	Y950	---	✓	90	Y1650	---	✓	165
Y531	449THFS8046	✓	96	Y633	SEE U513A	✓	161	Y951	---	✓	90	Y1651	---	✓	165
Y532	449THFS8047	✓	96	Y635	SEE U515A	✓	161	Y952	---	✓	90	Y1652	---	✓	165
Y533	449THFS8048	✓	96	Y637	SEE U517A	✓	162	Y953	---	✓	90	Y1999	182THFW7729	✓	92
Y534	056H17E5301	✓	93	Y639	SEE U519A	✓	162	Y954	---	✓	90	YA2020	Century	✓	214
Y535	056H17E5302	✓	93	Y641	SEE U538	✓	162	Y955	---	✓	90	YA2030	Century	✓	214
Y536	143THTR5326	✓	93	Y643	SEE U523A	✓	162	Y956	---	✓	90	YA2054	Century	✓	214
Y537	145THTR5376	✓	93	Y645	SEE U525A	✓	162	Y957	---	✓	90	Z112	SEE Z112A	✓	111
Y538	145THTR5326	✓	93	Y647	SEE U527A	✓	162	Y958	---	✓	90	Z112A	182TCFW9061	✓	111
Y540	184THTL7776	✓	93	Y649	SEE U529A	✓	162	Y978	143THFN8034	✓	96	Z113	SEE Z113A	✓	111
Y541	SEE Y541A	✓	93	Y651	SEE U531A	✓	162	Y979	145THFN8034	✓	96	Z113A	184TCFW9057	✓	111
Y541A	182THTY7726	✓	93	Y658	SEE U539A	✓	163	Y980	182THS8048	✓	96	Z114	SEE Z114A	✓	111
Y542	213THTL7776	✓	93	Y659	SEE U540A	✓	163	Y981	213THS8053	✓	96	Z114A	184TBFW7070	✓	111
Y543	184THTL7726	✓	93	Y663	SEE U521	✓	162	Y982	254THFN8058	✓	96	Z115	215TBFW7028	✓	111
Y543A	184THTY7726	✓	93	Y818A	326TTF6633	✓	215	Y983	254THFN8059	✓	96	Z116	215TBFW7044	✓	111
Y544	215THTL7776	✓	93	Y819A	364TTF6633	✓	215	Y984	256THFN17031	✓	96	Z117	213TBFW7027	✓	111
Y545	213THTL7726	✓	93	Y820A	365TTF6633	✓	215	Y985	284THFN8032	✓	96	Z118	145TBF5328	✓	110
Y546	254THTL5776	✓	93	Y822A	SEE Y822B	✓	215	Y986	143THTN8036	✓	97	Z119	SEE Z119A	✓	110
Y547	215THTL7726	✓	93	Y822B	405TTF6633	✓	215	Y987	145THTN8043	✓	97	Z119A	182TCFW7072	✓	110
Y548	256THTL5776	✓	93	Y824	SEE Y824A	✓	215	Y988	182THTS8048	✓	97	Z120	SEE Z120A	✓	110
Y549	254THTL5726	✓	93	Y824A	444TTF6633	✓	215	Y989	184THS8056	✓	97	Z120A	184TBFW17045	✓	110
Y551	145THFN8046	✓	93	Y826A	445TTFNA14571	✓	215	Y990	213THTS8071	✓	97	Z121	SEE Z121A	✓	110
Y552	256THTNA7026	✓	94	Y826B	445TTF6633	✓	215	Y991	215THTS8071	✓	97	Z121A	184TBFW7737	✓	110
Y553	284THNA7026	✓	94	Y828A	447TTF6633	✓	215	Y992	254THTNA8071	✓	97	Z122	215TBFW7029	✓	110
Y555	056H17E5311	✓	93	Y840A	365TTF6683	✓	215	Y993	256THTNA8071	✓	97	Z123	143TCFR5328	✓	110
Y556	056H17E5312	✓	93	Y850A	404TTF6683	✓	215	Y994	213THFW7726	✓	92	Z124	SEE Z124A	✓	171
Y557	145THTN8060	✓	93	Y852A	405TTF6683	✓	215	Y995	213THFW7736	✓	92	Z124A	184TBDW7369	✓	171

CAT. NO.	MODEL NO.	STOCK	PAGE NO.	CAT. NO.	MODEL NO.	STOCK	PAGE NO.	CAT. NO.	MODEL NO.	STOCK	PAGE NO.	CAT. NO.	MODEL NO.	STOCK	PAGE NO.
Z125	215TBDR7361		171	Z665	056E17T2005	√	103								
Z126	215TBDRW7362		171	Z666	056E17F2008	√	103								
Z127	256TBDX7028		171	Z667	056E17F2009	√	103								
Z128	145TBFR5341	√	110	Z668	056E17F2010	√	103								
Z129	256TBFR17026	√	111	Z669	056E17F2011	√	103								
Z304	145TBDR5309	√	117	Z670	056E17F2014	√	103								
Z305	SEE Z305A		117	Z671	056E17F2015	√	103								
Z305A	184TCDW7615	√	117												
Z306	SEE Z306A		117												
Z306A	184TCDW7617	√	117												
Z307	SEE Z307A		117												
Z307A	184TBDRW7009	√	117												
Z308	215TCDW7003	√	117												
Z309	182TCDR7013		117												
Z313	184TBDR7324		117												
Z314	215TCDW7012		117												
Z315	SEE Z315A		117												
Z315A	215TBDRW17003		117												
Z319	256TBDX17035	√	117												
Z401	143TCDR5328		144												
Z403	145TCDR5328		144												
Z404	145TBDR5304		144												
Z405	SEE Z405A		144												
Z405A	182TCDW7074	√	144												
Z406	SEE Z406A		144												
Z406A	182TCDW7318	√	144												
Z407	SEE Z407A		144												
Z407A	184TCDW7047	√	144												
Z408	SEE Z408A		144												
Z408A	184TBDRW17007	√	144												
Z409	213TCDW7027	√	144												
Z410	213TCDW7002	√	144												
Z411	215TBDRW7029	√	144												
Z412	215TCDW7002	√	144												
Z413	215TBDRW7027	√	144												
Z420	143TCDR5330		145												
Z422	145TCDR5329		145												
Z424	182TCDR7354		145												
Z425	182TCDR8005		145												
Z426	184TCDR7626		145												
Z427	SEE Z427A		145												
Z427A	184TBDRW17011	√	145												
Z428	213TCDW7028		145												
Z429	213TCDW7003	√	145												
Z430	215TBDRW7045		145												
Z431	215TCDW7004	√	145												
Z432	215TBDRW7030		145												
Z433	SEE Z433A		144												
Z433A	184TBFRW7315	√	144												
Z434	213TBFRW7010	√	144												
Z435	215TBFRW7010	√	144												
Z502	184TBDR5326	√	216												
Z504	184TBDR5301		216												
Z506A	184TBDRW7656		216												
Z602	056E17F1001	√	100												
Z603	056E17F1002	√	100												
Z604	056E17F1003	√	100												
Z605	056E17F1004		100												
Z606	056E17F1005	√	100												
Z607	056E17F1006	√	100												
Z610	056E17F1007	√	100												
Z611	056E17F1008	√	100												
Z612	056E17F2005	√	100												
Z613	056E17F2006	√	100												
Z614	056E17F2007	√	100												
Z615	145TEFRS326	√	100												
Z616	145TEFRS327	√	100												
Z617	182TEFRS326	√	100												
Z630	056E17V2001	√	102												
Z631	056E17V2002		102												
Z634	056E17V2003	√	102												
Z635	056E17V2004	√	102												
Z636	056E17V2005	√	102												
Z637	056E17V2006	√	102												
Z638	056E17W2001	√	102												
Z639	056E17W2002	√	102												
Z641	056E17W2003		102												
Z660	056E17T2001	√	103												
Z662	056E17T2002		103												
Z663	056E17T2003	√	103												
Z664	056E17T2004	√	103												

Index

Model Number/Catalog Number

INDEX

MODEL NO.	CAT. NO.	STOCK	PAGE NO.	MODEL NO.	CAT. NO.	STOCK	PAGE NO.	MODEL NO.	CAT. NO.	STOCK	PAGE NO.	MODEL NO.	CAT. NO.	STOCK	PAGE NO.
003062.36	A961A	✓	250	5K49DN4130	K252	✓	58	5KC35JN7X	G1115	✓	190	5KC46PN0359Y	C1489	✓	219
10003237-001-049	A960B	✓	250	5K49DN4131	K439	✓	52	5KC35JNA489	CG383	✓	219	5KC48UN6052	C1264	✓	190
4900030	A680	✓	251	5K49FN4129	K196	✓	52	5KC35JNA489Y	CG384	✓	219	5KC48UN6052X	C552	✓	190
4900670	A681A	✓	251	5K49FN4136	K154	✓	52	5KC35MNN145	C1405	✓	30	5KC49GN0001	B1316	✓	190
5K32GN30	K151	✓	52	5K49FN6381X	K2101	✓	84	5KC35MNN43	G1330	✓	34	5KC49GN0001X	CG223	✓	190
5K32GN48	K281	✓	195	5K49HN6385X	K2104	✓	84	5KC35MNN43X	G1331	✓	30	5KC49GN0001Y	C169	✓	216
5K32GN53	K418	✓	52	5K49JN4051T	K1476	✓	118	5KC35MNN73	G1513	✓	32	5KC49GN0022X	C1153	✓	190
5K32GNB249X	K717	✓	84	5K49JN4574X	K2105	✓	84	5KC36GN2507X	C1168	✓	137	5KC49HN0719	C1803	✓	37
5K33FN30	K153	✓	52	5K49JN4582X	K2102	✓	84	5KC36JN268X	C330	✓	139,201	5KC49HN2509	C1814	✓	38
5K33GN45	K275	✓	196	5K49KN2150X	K1413	✓	196	5KC36JN269X	C331	✓	139	5KC49LN6386	H891	✓	37
5K33JNA943	K253	✓	58	5K49KN4124	K258	✓	60	5KC36LN1	C215	✓	190	5KC49MNN2043Y	9031	✓	216
5K33KN52	K283	✓	195	5K49KN4142	K286	✓	195	5KC36LN144	C1420	✓	34	5KC49MNN2049Y	9032	✓	216,223
5K33KN67	K522	✓	58	5K49KN4563	K457	✓	108	5KC36LN144X	C444	✓	34	5KC49MNN6061	G1316	✓	30
5K33KN92	K194	✓	52	5K49KN4573	K456	✓	108	5KC36LN166X	C349	✓	32	5KC49MNN6063	C1423	✓	34
5K35FN101	K748	✓	140	5K49MN4104	K256	✓	58	5KC36LN18	C431	✓	24	5KC49MNN6379	C1818	✓	38
5K35FN55	KG215	✓	46,140,201	5K49MN4112	K524	✓	58	5KC36LN19X	C460	✓	190	5KC49MNN6384	C1801	✓	37
5K35JN47	K230	✓	141	5K49MN4114	K525	✓	195	5KC36LN1X	C216	✓	190	5KC49MNN0061T	4688	✓	191
5K35MN294	K282	✓	195	5K49MN4620X	K607	✓	73	5KC36LN26	C209	✓	190	5KC49MNN0222X	9030	✓	223
5K35MNN75	K321	✓	52	5K49MNN6020	K1316	✓	58	5KC36LN26X	C210	✓	190	5KC49MNN0224X	C1187	✓	191
5K35MNNB114	K254	✓	58	5K49MNN6079	K159	✓	52	5KC36LN4003Y	C664	✓	110	5KC49MNN2050Y	9033	✓	216
5K35MNNB117	K158	✓	52	5K49MNN6080	K285	✓	195	5KC36LN84X	C683	✓	139	5KC49MNN2081T	C1468	✓	170
5K36JN56	K217	✓	140	5K49MNN6081	K541	✓	195	5KC36MNN20	CG393	✓	27	5KC49MNN2130X	C273	✓	30
5K36JN57	K216	✓	46,140,201	5K49MNN6126T	K1487	✓	204	5KC36MNN2508X	C1169	✓	137	5KC49MNN2130Y	C274	✓	30
5K36MN339	KG232	✓	141	5K49MNN6369	K526	✓	108	5KC36MNN27X	C133	✓	190	5KC49MNN2132X	C445	✓	34
5K36MNA152	K633	✓	58	5K49MNN6382X	K2116	✓	84	5KC36PNB169	C646	✓	37	5KC49MNN2133X	C351	✓	32
5K36PN251	G1340	✓	53	5K49MNN6432S	K1500	✓	179	5KC37FN3900U	4788	✓	200	5KC49MNN2135X	C352	✓	139
5K36PN254	K523	✓	58	5K49MNN8349X	K2107	✓	84	5KC37FN65X	C329	✓	139	5KC49MNN2140X	C336	✓	139,201
5K36PN30	K155	✓	52	5K49NN2147X	K1416	✓	196	5KC37FN71X	J1025	✓	139,201	5KC49MNN2167X	C337	✓	139
5K36PN345S	K1403	✓	179	5K49NN2178	K225	✓	140	5KC37HN3898U	4781	✓	200	5KC49MNN2419Y	C663	✓	110
5K36PNB111	K161	✓	53	5K49NN2180	K224	✓	46,140,201	5KC37LN91	CG111	✓	27	5KC49PN0155	C235	✓	191
5K36PNB116	K255	✓	58	5K49NN4052T	K1438	✓	118	5KC37MN96	C459	✓	24	5KC49PN0155X	CG236	✓	191
5K37MNN252X	K1409	✓	196	5K49PN2330	KG236	✓	141	5KC37NN115X	C847	✓	139	5KC49PN0161U	C1158	✓	216,223
5K37MNN3543	K1483	✓	140	5K49PN2348	KG235	✓	58	5KC37NN14T	C457	✓	190	5KC49PN0164X	C1158	✓	191
5K37MNN37	K218	✓	46,140,201	5K49PN3052	K280	✓	196	5KC37NN160	C449	✓	27	5KC49PN0253	C1469	✓	219
5K37MNN38	KG219	✓	140	5K49PN3053	K279	✓	196	5KC37NN3544T	C1467	✓	170	5KC49PN0281X	C806	✓	195
5K37MNN30	K160	✓	53	5K49PN4088X	K1415	✓	196	5KC37RN35	CG260	✓	30	5KC49PN0283	C1425	✓	34
5K38PN258X	K1411	✓	196	5K49PN4113	K198	✓	53	5KC38NN410X	C1155	✓	191	5KC49PN2521Y	C704	✓	216
5K38PN47	K220	✓	46,140,201	5K49PN4121	K751	✓	140	5KC38NN413X	C1154	✓	191	5KC49PN3027X	C419	✓	190
5K38PN48	K221	✓	140	5K49PN4564	K458	✓	108	5KC38PN2509X	C1170	✓	137	5KC49PN3036	C248	✓	30
5K38RN30	K163	✓	53	5K49PN4565	K460	✓	108	5KC38SN2510X	C1171	✓	137	5KC49PN6051	C1258	✓	190
5K38SN267S	K1404	✓	179	5K49PN6019	K1300	✓	46	5KC39EN2500X	C1087	✓	137	5KC49PN6051X	C548	✓	190
5K39SNB505S	K1402	✓	179	5K49PN6025	K1317	✓	58	5KC39EN2553X	C1081	✓	137	5KC49PN6062	C1333	✓	30
5K39SNB587S	K1407	✓	179	5K49PN6164	K1490	✓	58	5KC39HN2501X	C1088	✓	137	5KC49Q00716	C1807	✓	37
5K39SNB765T	K1405	✓	179	5K49PN8030	K1318	✓	58	5KC39HN2554X	C1082	✓	137	5KC49RN2152T	C1159	✓	191
5K42FN4035	K1322	✓	60	5K49QN4609	K640	✓	59	5KC39HN2888X	C1462	✓	137	5KC49SN2156X	C855	✓	32
5K42GN4619X	K606	✓	73	5K49RN4570	K1494	✓	108	5KC39NN50X	C332	✓	139,201	5KC49SN2158	C1424	✓	32
5K42HN4034	K1324	✓	60	5K49RN6034S	K379	✓	179	5KC39PN5105X	C1083A	✓	137	5KC49SN2418U	C662	✓	110
5K42HN4089	K381	✓	196	5K49RN6118S	K1485	✓	178	5KC39PN6200X	C1089A	✓	137	5KC49SN5637S	C1809	✓	37
5K42HN4089X	K1408	✓	196	5K49RN6429S	K1510	✓	179	5KC39PN6201X	C1463A	✓	137	5KC49SN6380	C1817	✓	38
5K42HN4109	K197	✓	52	5K49SN2187	KG237	✓	59	5KC39QN3218X	C465	✓	139	5KC49SN8060T	C1273	✓	170
5K42HN4127	K249	✓	46	5K49SN3054	K518	✓	196	5KC39QN3219X	C333	✓	139	5KC49TN0033	C295	✓	30
5K42HN4128	K284	✓	195	5K49SN3055	K519	✓	196	5KC39QN3220X	C1152	✓	190	5KC49TN0034	C275	✓	30
5K42HN4133	K550	✓	141	5K49SN4117	K257	✓	58	5KC39RN114T	CG732	✓	139	5KC49TN0034X	C276	✓	30
5K42HN4134	K426	✓	52	5K49SN8050	K408	✓	40	5KC39RN383X	C1157	✓	191	5KC49TN0035	G1519	✓	32
5K42HN4137	K469	✓	58	5K49TN4622	K609	✓	73	5KC39RN44X	C334	✓	139,201	5KC49TN0063Y	F10E1	✓	110
5K42HN4139	K553	✓	140	5K49TN6383	K2110	✓	84	5KC39RN45X	C335	✓	139	5KC49TN0067	C376	✓	34
5K42JN3050	K546	✓	196	5K49UN4086X	K1418	✓	196	5KC39SN2810X	C1084	✓	137	5KC49TN0285X	C292	✓	195
5K42JN3051	K544	✓	196	5K49UN4566	K461	✓	108	5KC39SN2812X	C1090	✓	137	5KC49TN0568Y	C660	✓	110
5K42JN4163	K318	✓	39	5K49UN8052	KG319	✓	225	5KC39SN2890X	C1464	✓	137	5KC49TN2141X	C338	✓	139,201
5K46KN2082	K1484	✓	140	5K49VN4335X	K1497	✓	196	5KC42GN0014	C261	✓	30	5KC49TN2170X	C339	✓	139
5K46KN2172	K223	✓	140	5K49ZN2190	K240	✓	141	5KC42GN0014X	C262	✓	30	5KC49UN6065	C264	✓	30
5K46KN2173	K222	✓	46,140,201	5K49ZN4253	K1491	✓	59	5KC42GN0018	G1515	✓	32	5KC49UN6067	C1404	✓	32
5K46KN4085	K277	✓	196	5K49ZN6433S	K1520	✓	179	5KC42GN0018X	C446	✓	32	5KCP33GNA471S	P239	✓	118
5K46KN4085X	K1410	✓	196	5KC32GN13	C247	✓	195	5KC42GN0066	C375	✓	34	5KCP33GNA490S	PG240	✓	204
5K46KN4125	K250	✓	46	5KC32GN19	G1312	✓	30	5KC42GN0309X	C289	✓	195	5KCP35KNB057S	P250	✓	115
5K46KN4141	K555	✓	140	5KC32GN19X	CG251	✓	30	5KC46GN0075U	C1291	✓	112	5KCP35KNB650U	P254	✓	219
5K46LN6033S	K378	✓	179	5KC32GN25	G1511	✓	32	5KC46GN0251	C1458	✓	219	5KCP35GNA670T	P247	✓	219
5K46LN6428S	K1505	✓	179	5KC32GN9	C242	✓	30	5KC46GN0251Y	C1459	✓	219	5KCP36NNB059S	P251	✓	115
5K46MN4072	K122	✓	39	5KC32GN9X	C243	✓	30	5KC46GN0569Y	C661	✓	110	5KCP36NNB670U	PG252	✓	219
5K46MN4087	K278	✓	196	5KC33FN31	C1419	✓	32	5KC46JN0002X	C138	✓	191	5KCP36NNB671U	P253	✓	219
5K46MN4087X	K1412	✓	196	5KC33FN4180X	C1336	✓	139	5KC46JN00076U	C1292	✓	112	5KCP36RNA491S	P241	✓	204
5K46MN4144	K750	✓	140	5KC33KN19	C462	✓	30	5KC46LN0149X	C1156	✓	191	5KCP36SNB480S	P193	✓	177
5K46PN6082	K162	✓	53	5KC33MNN2502X	C1089	✓	137	5KC46LN0158	CG230	✓	191	5KCP36SNB481S	P194	✓	177
5K48TN2181	K227	✓	140	5KC33MNN2555X	C1083	✓	137	5KC46LN0158X	D1113	✓	191	5KCP36SNB482S	P195	✓	177
5K48TN2182	K226	✓	46,140,201	5K33MNN2889X	K1463	✓	137	5KC46LN0252	C1460	✓	219	5KCP36SNB763T	P196	✓	177
5K48TN6119S	K1486	✓	178	5KC35FN51X	C208	✓	190	5KC46LN0252Y	C1461	✓	219	5KCP39UNB764T	P198	✓	177
5K48TN6430S	K1515	✓	179	5KC35GNA488	CG382	✓	219	5KC46LN0254X	C1483	✓	191	5KCP39UNB767T	P197	✓	177
5K48UN3056	K520	✓	196	5KC35JN112	C200	✓	190	5KC46LN0269X	4686	✓	191	5KCP49PN9812S	P245	✓	175
5K48UN3057	K549	✓	196	5KC35JN12X	CG201	✓	190	5KC46PN0015	C268	✓	30	5KCP49RN9611S	P243	✓	175
5K48WN3013S	K1482	✓	179	5KC35JN23X	C129										

MODEL NO.	CAT. NO.	STOCK	PAGE NO.	MODEL NO.	CAT. NO.	STOCK	PAGE NO.	MODEL NO.	CAT. NO.	STOCK	PAGE NO.	MODEL NO.	CAT. NO.	STOCK	PAGE NO.
5KCP49UN9614S	P185	✓	175	5KH32DN5618X	HG701	✓	185	5KH36KNB633X	H344	✓	136	5KH39QN9632	H130	✓	187
5KCP49UN9811S	P246	✓	175	5KH32DNA612	H901	✓	25	5KH36LN488X	H691	✓	27	5KH39QN9636T	4757	✓	186
5KCP49UN9837S	F780	✓	117	5KH32DNA612X	H902	✓	25	5KH36LN489X	HG692	✓	186	5KH39QN9639T	4778	✓	187
5KCP49UN9838S	F781	✓	113	5KH32EN124	H244	✓	32	5KH36LNA504	H696	✓	27	5KH39QN9642T	H133	✓	187
5KCP49WN9813S	P180	✓	175	5KH32EN66	H116	✓	30	5KH36MN137	H290	✓	199	5KH39QN9682	4370	✓	186
5KCP49ZN9617T	P190	✓	172	5KH32EN72X	H291	✓	195	5KH36MN3106	H286	✓	187	5KH39QN9683	4396	✓	186
5KCR39SN2504X	C1091	✓	137	5KH32EN79	HG178	✓	195	5KH36MN3106X	H248	✓	187	5KH39QN9684	4387	✓	187
5KCR39SN2557X	C1085	✓	137	5KH32ENA443X	H682	✓	136	5KH36MN3127T	4684	✓	187	5KH39QN9686X	4362	✓	24
5KCR39SN2891X	C1465	✓	137	5KH32ENB168	H454	✓	37	5KH36MNA445X	H684	✓	136	5KH39QN9687	4422	✓	198
5KCR39UN2505X	C1092	✓	137	5KH32FN3083	H160	✓	185	5KH36MNA735X	H919	✓	187	5KH39QN9696X	4731	✓	187
5KCR39UN2511X	C1172	✓	137	5KH32FN3083X	HG161	✓	185	5KH36MNB637X	H926	✓	136	5KH39QN9697T	4759	✓	187
5KCR39UN2512X	C1173	✓	137	5KH32FN3120T	4680	✓	185	5KH36NN37	HG140	✓	115	5KH39QN9698T	4758	✓	187
5KCR39UN2558X	C1086	✓	137	5KH32FN3122	H134	✓	115	5KH36NN37S	HG141	✓	115	5KH39QN9702T	4732	✓	198
5KCR39UN2892X	C1466	✓	137	5KH32FN3122S	H135	✓	115	5KH36NNB166	HG455	✓	37	5KH39QN9703T	4738	✓	198
5KCR46JN0086X	E254	✓	190	5KH32FN3123	HG120	✓	30	5KH36PN106	H203	✓	115	5KH39QN9704T	4739	✓	198
5KCR46JN0087X	E257	✓	34	5KH32FN3123X	HG121	✓	30	5KH36PN108	HG189	✓	195	5KH39QN9725T	4730	✓	198
5KCR46JN0087Y	E255	✓	34	5KH32FN5586X	4406	✓	136	5KH36PN109	H233	✓	195	5KH39QN9767X	HG694	✓	187
5KCR46JN0088	E256	✓	32	5KH32FN5598X	HG680	✓	136	5KH36PNB171	HG458	✓	37	5KH39QNQA039	4390	✓	187
5KCR46JN0089	E258	✓	30	5KH32FNA499S	X1903	✓	115	5KH37GNA782X	HG717	✓	204	5KH39QNBB10	H645	✓	186
5KCR46MN0054X	E263	✓	190	5KH32FNA611	H903	✓	25	5KH37NNA768	H907	✓	25	5KH42GN0336	H1507	✓	195
5KCR46MN0055X	E266	✓	34	5KH32FNA611X	H904	✓	25	5KH37NNA768X	H908	✓	25	5KH42GN0337	HG143	✓	115
5KCR46MN0055Y	E264	✓	34	5KH32GN42	H195	✓	115	5KH37PN33	H171	✓	185	5KH42JN0328	H276	✓	115
5KCR46MN0093	E265	✓	32	5KH32GN42S	HG196	✓	115	5KH37PN33X	H172	✓	185	5KH42JN0328S	H247	✓	115
5KCR46MN0094	E267	✓	30	5KH32GN140X	HG152	✓	185	5KH37PN36	H209	✓	199	5KH46JN0329X	H693	✓	187
5KCR46TN0264T	C1303	✓	115	5KH32GN142	H204	✓	199	5KH37PN36X	H210	✓	199	5KH46MN3021X	HG155	✓	185
5KCR46TN142T	C340	✓	139,201	5KH32GN68X	H243	✓	30	5KH37PN37	H205	✓	199	5KH46MN3025	H173	✓	186
5KCR48TN2174T	C341	✓	139	5KH32GNB811X	4805	✓	136	5KH37PN37X	H278	✓	199	5KH46MN3025X	H174	✓	186
5KCR48TN2650Y	9035	✓	216	5KH32GNB812X	HG450	✓	136	5KH37PN39	H112	✓	185	5KH46MN3040	H225	✓	199
5KCR48TN3084X	C1479	✓	191	5KH32GNB813X	HG451	✓	136	5KH37PN39X	HG113	✓	185	5KH46MN3041	H207	✓	199
5KCR48TN8062	C194	✓	25	5KH32GNB814X	HG681	✓	136	5KH37PN40	H223	✓	199	5KH46MN6053	H162	✓	186
5KCR48UN105X	E281	✓	191	5KH32GNB815X	H712	✓	136	5KH37PN41	H158	✓	185	5KH46MN6053X	H163	✓	186
5KCR48UN2653Y	9036	✓	216	5KH32HNS620T	HG711	✓	186	5KH37PN41X	H159	✓	185	5KH46MN6071	H214	✓	199
5KCR48UN2654Y	9040	✓	216	5KH32HNA532T	4734	✓	198	5KH37PNA233	HG695	✓	185	5KH46MN6071X	H215	✓	199
5KCR48WN0273	G1376	✓	30	5KH32JN3128	H164	✓	186	5KH37PNA479X	HG714	✓	136	5KH46NN3039T	HG705	✓	186
5KCR48WN0273X	G1377	✓	30	5KH32JN3128X	H165	✓	186	5KH37PNA569T	HG706	✓	186	5KH46NN3033	HG191	✓	195
5KCR48WN0292	C297	✓	30	5KH33FN6	H239	✓	24	5KH38SNA731T	HG715	✓	187	5KH46PN3034	H293	✓	195
5KCR48WN0292Y	F15E1	✓	110	5KH33FN7	H212	✓	199	5KH39DNA533T	4733	✓	198	5KH46PN6059	HG186	✓	195
5KCR48WN0294	G1531	✓	32	5KH33FN7X	H213	✓	199	5KH39EN2506X	H440	✓	137	5KH48UN6054X	H298	✓	187
5KCR48WN0566Y	C659	✓	110	5KH33FN85	HG123	✓	30	5KH39EN2552X	H439	✓	137	5KH48UN6074	H221	✓	199
5KCR48WN6066	C271	✓	30	5KH33FN85X	HG124	✓	30	5KH39EN2887X	H685	✓	137	5KH49MN3035	H190	✓	195
5KCR49PN0077U	C1293	✓	112	5KH33FNA230	H675	✓	185	5KH39QN5508	4369	✓	186	5KH49MN6057	H136	✓	115
5KCR49PN0098X	EG272	✓	191	5KH33FNA722X	H915	✓	185	5KH39QN5508X	4310	✓	186	5KH49MN6057S	H137	✓	115
5KCR49PN0099X	E275	✓	34	5KH33GNS014U	4774	✓	200	5KH39QN5511X	4305	✓	185	5KH49MN6060	HG182	✓	195
5KCR49PN0099Y	EG273	✓	34	5KH33GNA444X	H683	✓	136	5KH39QN5512T	4701	✓	185	5KH49PN3026	H175	✓	187
5KCR49PN100	E274	✓	32	5KH33HN5725X	4702	✓	185	5KH39QN5523	4359	✓	185	5KH49PN3026X	H176	✓	187
5KCR49PN101	EG276	✓	30	5KH33JN3121	HG138	✓	115	5KH39QN5524	4377	✓	186	5KH49PN3042	H226	✓	199
5KCR49PN0492S	C1314	✓	115	5KH33JN3121S	H139	✓	115	5KH39QN5525	4355	✓	185	5KH49PN3042X	H282	✓	199
5KCR49PN3011	C420	✓	191	5KH33JNA500S	X1904	✓	115	5KH39QN5526X	4363	✓	186	5KH49PN3043	H620	✓	185
5KCR49PN3011X	C474	✓	191	5KH33JNA511T	HG710	✓	187	5KH39QN5528X	4381	✓	186	5KH49PN3045	H275	✓	187
5KCR49PN3012X	C486	✓	191	5KH33JNA534T	4735	✓	198	5KH39QN5529	4371	✓	186	5KH49PN3047	H222	✓	199
5KCR49RN2148T	C1161	✓	191	5KH33KN20S	H277	✓	115	5KH39QN5529X	4311	✓	186	5KH49PN6055	H168	✓	186
5KCR49SN0012X	CG239	✓	191	5KH33KN5594	H673	✓	186	5KH39QN5537X	4306	✓	186	5KH49PN6055X	HG621	✓	186
5KCR49SN0042S	C1302	✓	115	5KH35FN124	H114	✓	186	5KH39QN5538X	4350	✓	185	5KH49PN6056	HG142	✓	115
5KCR49SN0065	C191	✓	25	5KH35FN124X	HG115	✓	186	5KH39QN5539T	4776	✓	186	5KH49PN6056S	HG699	✓	115
5KCR49SN0150X	C1160	✓	191	5KH35FN153T	4798	✓	186	5KH39QN5543	4304	✓	185	5KH49PN6069	H219	✓	199
5KCR49SN0493S	C1315	✓	115	5KH35GNA229	H676	✓	27	5KH39QN5548	4360	✓	186	5KH49SN3023X	H288	✓	199
5KCR49SN3009	C475	✓	191	5KH35HN9	H229	✓	27	5KH39QN5550X	4404	✓	204,212	5KH49SN3046	H296	✓	186
5KCR49SN3009X	C1478	✓	191	5KH35JN26	H166	✓	186	5KH39QN5558T	4722	✓	204,212	5KH49SN3048	H300	✓	186
5KCR49SN3010	C476	✓	191	5KH35JN26X	H167	✓	186	5KH39QN9091	H230	✓	27	5KH49SN3049	H224	✓	199
5KCR49TN2139U	G1392	✓	31	5KH35JN121	H217	✓	199	5KH39QN9105	B1502	✓	195	5KH49UN3024X	H280	✓	199
5KCR49TN2155T	C466	✓	32	5KH35JN121X	H218	✓	199	5KH39QN9105X	H234	✓	195	5KH49UN6064	HG188	✓	195
5KCR49TN2164T	C878	✓	139	5KH35JN3132T	4682	✓	186	5KH39QN9397	4368	✓	27	5KHC37NNA167T	HG700	✓	186
5KCR49TN8058T	C1274	✓	170	5KH35JN602X	HG690	✓	186	5KH39QN9405X	4392	✓	187	5KHC39QN9575T	H649	✓	115
5KCR49UN0079U	C1294	✓	112	5KH35JN603X	H689	✓	27	5KH39QN9429T	4319	✓	186	5KHC39QN9581T	HG648	✓	115
5KCR49UN106X	EG284	✓	34	5KH35JNA231	H674	✓	186	5KH39QN9508Y	HG646	✓	112	5KHC39QN9584X	H647	✓	115
5KCR49UN106Y	EG282	✓	34	5KH35JNA723X	H917	✓	186	5KH39QN9513X	4383	✓	186	5KS49HNA595	E286	✓	122
5KCR49UN107	EG283	✓	32	5KH35JNB164	HG456	✓	37	5KH39QN9514X	4309	✓	186	048A11D245	X262	✓	203
5KCR49UN108	E285	✓	30	5KH35MN132	H197	✓	115	5KH39QN9518X	4602	✓	187	048A11O1044	X471	✓	183
5KCR49WN0270T	CG381	✓	25	5KH35MN132S	H198	✓	115	5KH39QN9537X	4349	✓	24	048A11O1045	X472	✓	183
5KCR49WN0295U	C1295	✓	112	5KH35MN56	B1504	✓	195	5KH39QN9538	4354	✓	24	048A11O1046	X473	✓	183
5KCR49WN6077	CG232	✓	191	5KH35MN56X	H236	✓	195	5KH39QN9541T	4338	✓	187	048A11O1047	X474	✓	183
5KCR49WN6078	C1412	✓	34	5KH35MNA519T	HG703	✓	187	5KH39QN9542	4351	✓	27	048A11O1060	X200	✓	212
5KCR49ZN0785S	C1909	✓	115	5KH35MNA568T	HG704	✓	185	5KH39QN9543	4373	✓	27	048A11O1062	X203	✓	207
5KCR49ZN7222Y	90388	✓	216	5KH36DNA780X	HG716	✓	204	5KH39QN9544X	4393	✓	187	048A11O1065	X212	✓	212
5KCR49ZN8061T	C1275	✓	170	5KH36JNA769	H905	✓	25	5KH39QN9546	4372	✓	27	048A11O1068	X210	✓	207
5KE49WN4572	K2046	✓	108	5KH36JNA769X	H906	✓	25	5KH39QN9547	4376	✓	27	048A11O1081	X215	✓	212
5KH32DN111	H208	✓	199	5KH36KN112	H206	✓	199	5KH39QN9548	4322	✓	185	048A11O1097	X216	✓	173,211
5KH32DN3085	HG156	✓	185	5KH36KN112X	H287	✓	199	5KH39QN9548X	4389	✓	185	048A11O11040	X264	✓	203
5KH32DN3085X	H157	✓	185	5KH36KN113X	HG154	✓	185	5KH39QN9550X	4412	✓	185	048A11O11041	X263	✓	203
5KH32DN5587X	47														

Index

Model Number/Catalog Number

INDEX

MODEL NO.	CAT. NO.	STOCK	PAGE NO.	MODEL NO.	CAT. NO.	STOCK	PAGE NO.	MODEL NO.	CAT. NO.	STOCK	PAGE NO.	MODEL NO.	CAT. NO.	STOCK	PAGE NO.
048A1101064	X073	✓	206	048A110787	X009	✓	182	048A802001	X086	✓	172	048T17V11001	N701	✓	135
048A1101066	X077	✓	206	048A110840	X096	✓	172	048A8T71	X450	✓	174	048T17V11002	N704	✓	135
048A1101109	X222	✓	207	048A110885	X470	✓	211	048A8T72	X451	✓	174	52A101229AAG1	A549	✓	248
048A1101167	X258	✓	184	048A110900	X057	✓	184	048A8T73	X452	✓	174	52A103486G1	A964	✓	250
048A1101239	X268	✓	203,213	048A110901	X056	✓	184	048A8T11002	X465	✓	174	52D310814AAP1	A942	✓	250
048A1101350	X018	✓	182	048A1102042	X003	✓	182	048B17D11003	C164A	✓	24	52D310822ACP1	A962	✓	250
048A1101351	X019	✓	182	048A111198	X303	✓	204	048B17D11004	C153A	✓	24	52D310833AAP001	A940	✓	250
048A1101352	X020	✓	182	048A111199	X302	✓	204	048B17D11005	C147A	✓	24	52D311808ARP1	A941	✓	250
048A1101353	X021	✓	182	048A111201	X304	✓	204	048B17D11010	C154A	✓	24	52D311819ABP1	A963	✓	250
048A1101375	X426	✓	172,203	048A111276	X469	✓	174	048B17D11014	S011A	✓	27	056A11029	X432	✓	173
048A1101410	X295	✓	213	048A111463	X430	✓	174	048B17D11015	C148A	✓	24	056A11030	X433	✓	173
048A1101461	X431	✓	174	048A111509	X297	✓	173,211	048B17D11016	S030A	✓	27	056A1105305	X271	✓	175
048A1101524	X213	✓	172	048A111529	X413	✓	174	048B17D11017	G078A	✓	24	056A1105310	X206	✓	175
048A1101525	X214	✓	172	048A111569	X412	✓	174	048B34D11002	G091A	✓	24	056A1105311	X207	✓	175
048A1101526	X221	✓	172	048A111571	X414	✓	174	048B34D11003	G1098A	✓	24	056A1105313	X218	✓	212
048A1101583	X023	✓	182	048A111578	X456	✓	174	048C17D2023	S010	✓	27	056A1105314	X448	✓	177
048A1101596	X444	✓	173	048A111579	X457	✓	174	048C17D2028	S110	✓	190	056A1105315	X449	✓	177
048A1101642	X447	✓	177	048A111580	X458	✓	174	048C17D2029	S111	✓	190	056A805	X208	✓	172
048A1101643	X446	✓	177	048A111581	X459	✓	174	048C17D2041	B312	✓	190	056B11D11003	C1252A	✓	24
048A1101674	X033	✓	182,211	048A111619	X462	✓	174	048C17D2042	B313	✓	190	056B11D15504	C1422A	✓	28
048A1101732	X445	✓	177	048A111646	X072	✓	205	048C17D2043	B314	✓	190	056B11D15505	C1263A	✓	24
048A1101744	X405	✓	207	048A1112008	X411	✓	211	048C17D2044	B315	✓	190	056B11D15506	C178A	✓	24
048A1101756	X005	✓	182	048A1112012	X415	✓	174	048C17D2045	S118	✓	190	056B11D15507	G579	✓	36
048A1101769	X002	✓	182	048A1112013	X416	✓	174	048C17D2046	S119	✓	190	056B11F5303	G578	✓	36
048A1101770	X455	✓	172	048A1112017	X427	✓	174	048C17D2055	D119	✓	190	056B11G5301	G655	✓	37
048A1101771	X453	✓	172	048A1112020	X429	✓	174	048C17D2057	X600	✓	210	056B11G5302	K016	✓	216,223
048A1101772	X036	✓	183	048A1112021	X027	✓	114	048C17F11005	F1201	✓	112	056B17D67	B353	✓	190
048A1101773	X034	✓	183	048A1112022	X028	✓	114	048C17F11006	F1202	✓	112	056B17D2012	G156	✓	191
048A1101774	X035	✓	183	048A1112023	X029	✓	114	048C17F11007	F1203	✓	112	056B17D2013	B609	✓	191
048A1101798	X000	✓	182	048A1112024	X923	✓	213	048C34D2024	O010	✓	200	056B17D5319	G979	✓	223
048A1101799	X001	✓	182	048A1112025	X924	✓	213	048C34D2028	O011	✓	200	056B17D5322	K232	✓	223
048A1101874	X038	✓	183	048A1112026	X925	✓	213	048C34S24	O012	✓	200	056B17D5323	G958	✓	223
048A1101875	X039	✓	183	048A111T11006	X076	✓	205	048C34S2001	O013	✓	200	056B17D5328	G290	✓	223
048A1101876	X037	✓	183	048A17069	X040	✓	184	048N17D114	B703	✓	186	056B17D5331	B352	✓	191
048A1102001	X006	✓	182	048A17070	X041	✓	184	048N17D997	B400	✓	171	056B17D5701	B332	✓	191
048A1102007	X090	✓	172	048A170123	X475	✓	183	048S17D2017	D107	✓	185	056B17D5703	B335	✓	191
048A1102009	X062	✓	184	048A170124	X476	✓	183	048S17D2042	S102	✓	185	056B17D11017	G234A	✓	28
048A1102011	X064	✓	184	048A170125	X211	✓	182,208	048S17D2052	B300	✓	185	056B17D11014	G230A	✓	28
048A1102012	X065	✓	184	048A170128	X477	✓	183	048S17D2053	B322	✓	185	056B17D11015	G212A	✓	28
048A1102013	X066	✓	184	048A170136	X230	✓	203,209	048S17D2054	B302	✓	185	056B17D11018	C167A	✓	24
048A1102014	X067	✓	184	048A170147	X269	✓	203,210	048S17D2055	B303	✓	185	056B17D11019	C158A	✓	24
048A1102015	X068	✓	184	048A170149	X270	✓	203,212	048S17D2056	B304	✓	186	056B17D11020	E253A	✓	24
048A1102016	X099	✓	172	048A170151	X015	✓	182	048S17D2057	B305	✓	186	056B17D11021	E251A	✓	28
048A1102017	X400	✓	172	048A170152	X013	✓	182	048S17D2058	B306	✓	187	056B17D11022	E262A	✓	24
048A1102022	X061	✓	184	048A170153	X016	✓	182	048S17D2059	B307	✓	187	056B17D11023	E260A	✓	28
048A1102024	X070	✓	184	048A170154	X014	✓	182	048S17D2086	D143	✓	186	056B17D11028	S033A	✓	27
048A1102026	X071	✓	184	048A170155	X017	✓	182	048S17D2087	D162	✓	187	056B17D11029	E261A	✓	29
048A1102028	X063	✓	184	048A170161	X273	✓	207	048S17D2088	D163	✓	187	056B17D11030	C168A	✓	24
048A1102029	X087	✓	172	048A170169	X420	✓	172	048S17D2089	S003	✓	27	056B17D11031	E259A	✓	29
048A1102031	X081	✓	172	048A170172	X422	✓	172	048S17D2090	S006	✓	27	056B17D11032	E252A	✓	29
048A1102032	X088	✓	172	048A170174	X022	✓	182	048S17D2091	S103	✓	185	056B17D11033	C359A	✓	28
048A1102034	X083	✓	172	048A170250	X454	✓	172	048S17D2093	S106	✓	195	056B17D11034	G095A	✓	24
048A1102035	X089	✓	172	048A1702001	X058	✓	184	048S17D2104	S126	✓	185	056B17D11036	C356A	✓	28
048A1102046	X010	✓	182	048A1702002	X059	✓	184	048S17D2105	S127	✓	195	056B17D11037	C159A	✓	24
048A1102047	X219	✓	182	048A1702003	X060	✓	184	048S17D2106	S128	✓	187	056B17D11038	CG105A	✓	27
048A1102050	X223	✓	207	048A1702004	X069	✓	184	048S17D2107	B206	✓	185	056B17D11039	C354A	✓	28
048A1102051	X417	✓	182	048A1702005	X011	✓	172,182	048S17D2108	B207	✓	186	056B17D11035	K235A	✓	29
048A1102052	X418	✓	182	048A1702006	X012	✓	172,182	048S17D2109	B208	✓	187	056B17D11040	K234A	✓	29
048A1102053	X419	✓	182	048A17172	X301	✓	204	048S17D2113	S026	✓	27	056B17D11041	E250A	✓	29
048A1102054	X424	✓	172	048A17186	X466	✓	174	048S17D2116	B606	✓	186	056B17D11042	S013A	✓	27
048A1102055	X423	✓	172	048A17187	X467	✓	174	048S17D2117	B607	✓	186	056B17D115541	G270A	✓	28
048A1102059	X298	✓	172	048A17196	X468	✓	174	048S17D7204	D180	✓	185	056B17D115542	C181A	✓	24
048A1102062	X441	✓	173	048A17118	X030	✓	114	048S17D7205	D181	✓	186	056B17D115543	G256A	✓	28
048A1102063	X443	✓	173	048A17119	X032	✓	114	048S17D7209	B402	✓	171	056B17D115544	CG361A	✓	28
048A1102064	X442	✓	173	048A171237	X031	✓	114	048S17S24	O003	✓	200	056B17D115545	C175A	✓	24
048A1102065	X440	✓	173	048A171356	X463	✓	174	048S17S25	O002	✓	200	056B17D115548	C185A	✓	25
048A110251	X260	✓	209	048A171359	X464	✓	174	048S17T286	O600	✓	200	056B17D115549	E280A	✓	24
048A110653	X042	✓	184	048A1712004	X305	✓	204	048S17T290	O601	✓	200	056B17D115550	E269A	✓	28
048A110654	X043	✓	184	048A1712002	X024	✓	114	048S17T365	X911	✓	117	056B17D115551	EG271A	✓	24
048A110655	X044	✓	184	048A1712003	X025	✓	114	048S17T366	X910	✓	117	056B17D115554	G274A	✓	28
048A110656	X045	✓	184	048A1712004	X026	✓	114	048S17T2004	X909	✓	117	056B17D115555	C193A	✓	25
048A110678	X085	✓	172	048A1712005	X920	✓	213	048S34S361	O100	✓	200	056B17DRC70002A1	CG362A	✓	28
048A110694	X237	✓	182,207	048A1712006	X921	✓	213	048S34S2003	O004	✓	200	056B17DRC70005A1	CG363A	✓	28
048A110697	X241	✓	182,207	048A1712007	X922	✓	213	048S34S2004	O005	✓	200	056B17DRR70004A1	C176A	✓	24
048A110699	X236	✓	182,207	048A34SU1000	X004	✓	182	048S34S2005	O102	✓	200	056B17DRR70005A1	E270A	✓	29
182,207,211				048A34SU1001	O701	✓	200	048T34D11001	K113A	✓	39	056B17DRR70007A1	S015A	✓	27
048A110756	X242	✓	182,207	048A80151	X261	✓	209	048T3							

MODEL NO.	CAT. NO.	STOCK	PAGE NO.	MODEL NO.	CAT. NO.	STOCK	PAGE NO.	MODEL NO.	CAT. NO.	STOCK	PAGE NO.	MODEL NO.	CAT. NO.	STOCK	PAGE NO.
056B17DRR70017A1	C182A	✓	24	056C17D2061	S115	✓	191	056C17W5332	N559	✓	121	056E17T2004	Z664	✓	103
056B17DRR70018A1	S038A	✓	27	056C17D2072	B317	✓	190	056C17W5333	N541	✓	121	056E17T2005	Z665	✓	103
056B17DRR70019A1	E6277A	✓	29	056C17D2073	B318	✓	191	056C17W5334	N543	✓	121	056E17V2001	Z630	✓	102
056B17DRR70020A1	S039A	✓	27	056C17D2074	B319	✓	191	056C17W5335	N545	✓	121	056E17V2002	Z631	✓	102
056B17DRR70022A1	C186A	✓	25	056C17D2079	D111	✓	190	056C17W5336	N680	✓	121	056E17V2003	Z634	✓	102
056B17F5302	G378	✓	30,224	056C17D2088	G135	✓	190	056C17W5337	N681	✓	121	056E17V2004	Z635	✓	102
056B17F5305	G574	✓	36	056C17D2097	S112	✓	190	056C17W5338	N682	✓	121	056E17V2005	Z636	✓	102
056B17F5306	G575	✓	36	056C17D2098	S012	✓	27	056C17WD5327	N341	✓	127	056E17V2006	Z637	✓	102
056B17F5307	F105	✓	110	056C17D2099	S113	✓	190	056C17WD5328	N343	✓	127	056E17W2001	Z638	✓	102
056B17F5310	G396	✓	224	056C17D2100	B210	✓	190	056C17WD5329	N345	✓	127	056E17W2002	Z639	✓	102
056B17F5319	K319	✓	34,110,224	056C17D2101	X601	✓	210	056C17WD5330	N347	✓	127	056E17W2003	Z641	✓	102
056B17F5324	X902	✓	113	056C17D2102	X602	✓	210	056C34D2098	Q212	✓	201	056H17E5301	Y600	✓	94
056B17F5328	T018	✓	225	056C17D2113	B608	✓	190	056C34D2099	Q213	✓	201	056H17E5302	Y601	✓	94
056B17F5329	T030	✓	225	056C17D5308	G951	✓	216	056C34D2104	Q214	✓	201	056H17E5303	Y602	✓	94
056B17F5330	D404	✓	107	056C17D5319	S037	✓	27	056C34D2105	Q217	✓	201	056H17E5304	Y603	✓	94
056B17F5584	F135	✓	34,110	056C17D5322	B311	✓	191	056C34D2106	D118	✓	191	056H17E5305	Y604	✓	94
056B17F15516	F1205	✓	112	056C17D5339	S116	✓	191	056C34D2109	Q211	✓	201	056H17F2011	Y506	✓	91
056B17G15522	G691	✓	37	056C17D5340	S117	✓	191	056C34D2112	Q215	✓	201	056H17F2012	Y507	✓	91
056B17T20	X913	✓	113	056C17D5346	X603	✓	210	056C34D2114	Q210	✓	201	056H17F2013	Y508	✓	91
056B17T5303	X912	✓	113	056C17D5347	B336	✓	191	056C34D2118	J054	✓	139	056H17F2014	Y521	✓	91
056B17V5301	N272	✓	130	056C17D5348	B337	✓	191	056C34D2119	J055	✓	139	056H17F2015	Y363	✓	91
056B17V5302	N273	✓	130	056C17D5349	B338	✓	191	056C34D2120	J056	✓	139	056H17F2016	Y377	✓	91
056B17V5303	N283	✓	130	056C17E5302	K032	✓	37	056C34D2121	J057	✓	139	056H17F2017	Y362	✓	91
056B17V5304	N285	✓	130	056C17E5314	G639	✓	37	056C34F5301	D311	✓	36	056H17F2018	Y376	✓	91
056B34D2018	K212	✓	223	056C17E5319	G852	✓	38	056C34F5302	D312	✓	36	056H17F2019	Y365	✓	91
056B34D2021	G987	✓	223	056C17E15513	G639A	✓	37	056C34F5303	D313	✓	36	056H17F2020	Y379	✓	91
056B34D2027	D115	✓	191	056C17F15537	F1204	✓	112	056C34F5307	G393	✓	30	056H17F2021	Y364	✓	91
056B34D2028	O231	✓	201	056C17F2049	G332	✓	30	056C34F5308	G352	✓	30	056H17F2022	Y378	✓	91
056B34D2029	D010	✓	216,223	056C17F2051	G339	✓	30	056C34F5309	G379	✓	30,224	056H17T2001	Y582	✓	93
056B34D2033	J058	✓	139	056C17F2052	G314	✓	30	056C34F5310	G359	✓	30	056H17T2011	Y500	✓	91
056B34D5302	D017	✓	216	056C17F5308	G356	✓	30	056C34F5311	G390	✓	30,224	056H17T2012	Y501	✓	91
056B34D5304	G976	✓	223	056C17F5311	G373	✓	30,224	056C34F5322	G514	✓	32	056H17T2013	Y502	✓	91
056B34D5307	G294	✓	223	056C17F5320	G570	✓	36	056C34F5323	G516	✓	32	056H17T2014	Y503	✓	91
056B34D5320	K152	✓	191	056C17F5321	G571	✓	36	056C34F5324	G518	✓	32	056H17T2015	Y504	✓	91
056B34D5334	G996	✓	223	056C17F5322	G572	✓	36	056C34F5327	K339	✓	30	056H17T2016	Y505	✓	91
056B34D5336	K219	✓	223	056C17F5323	G573	✓	36	056C34F5339	T015	✓	225	056H17T2017	Y360	✓	91
056B34D5337	O232	✓	201	056C17F5324	F101	✓	110	056C34F5340	T013	✓	225	056H17T2018	Y374	✓	91
056B34D5341	J059	✓	139	056C17F5325	F102	✓	110	056C34G5308	G653	✓	37	056H17T2019	Y361	✓	91
056B34D11011	C187A	✓	25	056C17F5326	F103	✓	110	056C34G5309	G656	✓	37	056H17T2020	Y375	✓	91
056B34D11012	G937A	✓	25	056C17F5327	F104	✓	110	056C34G5310	G658	✓	37	056H17T2021	Y605	✓	91
056B34D11013	G258A	✓	28	056C17F5349	T016	✓	225	056C34G5311	G854	✓	38	056H17T2022	Y606	✓	91
056B34D11014	C179A	✓	24	056C17F5350	T014	✓	225	056C34G5314	G873	✓	38	056H17T5301	Y534	✓	93
056B34D11015	G254A	✓	28	056C17F5351	T010	✓	225	056C34G5315	G875	✓	38	056H17T5302	Y535	✓	93
056B34D11016	G238A	✓	28	056C17F5352	D400	✓	107	056C34G5316	G858	✓	38	056H17T5311	Y555	✓	93
056B34D11017	G232A	✓	28	056C17F5353	D401	✓	107	056C34W5301	N284	✓	130	056H17T5312	Y556	✓	93
056B34D11018	G216A	✓	28	056C17F5354	D402	✓	107	056C34W5302	N281	✓	130	056H17T15526	Y280	✓	92
056B34D11019	G915A	✓	24	056C17F5355	D403	✓	107	056C34W5301	N530	✓	121	056H17T15527	Y282	✓	92
056B34D11021	C1474A	✓	24	056C17F5358	F131	✓	34,110	056C34W5302	N532	✓	121	056H17T15528	Y281	✓	92
056B34D11022	C1475A	✓	24	056C17F5912	F132	✓	34,110	056C34W5303	N524	✓	121	056PRRA10161	SY035	✓	99
056B34D15528	G272A	✓	28	056C17F5913	F133	✓	34,110	056C34W5304	N526	✓	121	056PNRA10100	SY001	✓	99
056B34D15532	D019	✓	216	056C17F5914	F134	✓	34,110	056C34W5305	N528	✓	121	056PNRA10101	SY003	✓	99
056B34D15536	C703A	✓	25	056C17F5955	G381	✓	224	056C34W5306	N556	✓	121	056PNRA10102	SY004	✓	99
056B34D15537	C1269A	✓	29	056C17F5956	G382	✓	224	056C34W5307	N558	✓	121	056PNRA10103	SY005	✓	99
056B34D15538	C1270A	✓	29	056C17F5957	G380	✓	224	056C34W5308	N540	✓	121	056S17D2023	S120	✓	187
056B34D99007	C180A	✓	24	056C17G5308	K037	✓	37	056C34W5309	N542	✓	121	056S17D2046	S022	✓	27
056B34D99008	C1477A	✓	25	056C17G5315	G651	✓	37	056C34W5310	N544	✓	121	056S17D2047	B201	✓	185
056B34D99009	C702A	✓	24	056C17G5316	G654	✓	37	056C34W99003	N546	✓	121	056S17D2048	B202	✓	186
056B34F5303	K332	✓	224	056C17G5317	G657	✓	37	056C34W5301	N340	✓	127	056S17D2049	B200	✓	187
056B34F5306	K612	✓	224	056C17G5318	G659	✓	37	056C34W5302	N342	✓	127	056S17D2050	D149	✓	187
056B34F5312	K615	✓	224	056C17G5320	G853	✓	38	056C34W5303	N344	✓	127	056S17D2062	B401	✓	171
056B34F5318	K618	✓	224	056C17G5321	G855	✓	38	056C34W5304	N346	✓	127	056S17D2064	B100	✓	187
056B34F5319	G533	✓	32	056C17G5322	G857	✓	38	056E17F1001	Z602	✓	100	056S17D2066	S027	✓	27
056B34F5320	G374	✓	30	056C17G5323	G870	✓	38	056E17F1002	Z603	✓	100	056S17F5303	B506	✓	195
056B34F5321	G391	✓	30	056C17G5324	G871	✓	38	056E17F1003	Z604	✓	100	056S34D93	O201	✓	201
056B34F5322	K350	✓	31	056C17G5326	G874	✓	38	056E17F1004	Z605	✓	100	056S34D2000	O200	✓	201
056B34F5324	K631	✓	34	056C17G5327	G876	✓	38	056E17F1005	Z606	✓	100	056S11D5209	X235	✓	208
056B34F5326	D314	✓	36	056C17G5328	G872	✓	38	056E17F1006	Z607	✓	100	056T11D5304	K007	✓	40
056B34F5327	D315	✓	36	056C17G15555	G651A	✓	37	056E17F1007	Z610	✓	100	056T11D11005	G061A	✓	39
056B34F5328	D316	✓	36	056C17G15556	G654A	✓	37	056E17F1008	Z611	✓	100	056T11D15522	G067A	✓	39
056B34F5332	T017	✓	225	056C17G15557	G657A	✓	37	056E17F2005	Z612	✓	100	056T11D15523	K1299A	✓	46
056B34F5333	T019	✓	225	056C17G15558	G659A	✓	37	056E17F2006	Z613	✓	100	056T11D15524	K1300A	✓	46
056B34W5301	N286	✓	130	056C17V5301	N282	✓	130	056E17F2007	Z614	✓	100	056T11D15525	G088A	✓	39
056C11D5304	G278	✓	199	056C17V5302	N271	✓	130	056E17F2008	Z666	✓	103	056T11D15526	K007A	✓	40
056C11F5302	G577	✓	36	056C17V5303	N280	✓	130	056E17F2009	Z667	✓	103	056T11F5308	G589	✓	60
056C11F5303	G576	✓	36	056C17V5304	N270	✓	130	056E17F2010	Z668	✓	103	056T11F5309	G588	✓	60
056C11G5303	K033	✓	37	056C17W5326	N531	✓	121	056E17F2011	Z669	✓	103	056T11F5310	G587	✓	60
056C11G5306	G650	✓	37	056C17W5327	N523	✓	121	056E17F2012	Z670	✓	103	056T11F5311	G586	✓</	

Index

Model Number/Catalog Number

INDEX

MODEL NO.	CAT. NO.	STOCK	PAGE NO.	MODEL NO.	CAT. NO.	STOCK	PAGE NO.	MODEL NO.	CAT. NO.	STOCK	PAGE NO.	MODEL NO.	CAT. NO.	STOCK	PAGE NO.
056T11F15521	K701A	✓	60	056T17D5385	G967	✓	196	056T17F15668	G365A	✓	53	056T17W5341	N627	✓	124
056T11F15525	G360A	✓	53	056T17D5398	H803	✓	41	056T17F15669	G396A	✓	54	056T17W5344	N322	✓	122
056T11F15527	K407A	✓	58	056T17D5701	G161	✓	196	056T17F15674	G548A	✓	58	056T17W99002	N669	✓	123
056T11G15528	K2110A	✓	84	056T17D11040	G086A	✓	39	056T17F15677	D457A	✓	109	056T17W99003	N666	✓	123
056T11F15531	K471	✓	108	056T17D11041	G082A	✓	39	056T17F15901	G528A	✓	58	056T17W99004	N633	✓	124
056T11F15532	K466	✓	108	056T17D11042	G243A	✓	46	056T17F15902	K1476B	✓	118	056T17W99005	N632	✓	124
056T11F15533	K435	✓	108	056T17D11043	G065A	✓	39	056T17F15903	G549A	✓	59	056T17W99006	N668	✓	123
056T11F15534	K437	✓	108	056T17D11044	G062A	✓	39	056T17F15913	K470	✓	108	056T17W99007	N715	✓	135
056T11F15535	K468	✓	108	056T17D11045	G242A	✓	46	056T17F15914	K467	✓	108	056T17W99008	N770	✓	135
056T11015	X259	✓	210	056T17D11046	K049A	✓	39	056T17F15915	K440	✓	108	056T17W99009	N720	✓	135
056T1105300	X500	✓	179	056T17D11047	K003A	✓	39	056T17F15916	K463	✓	108	056T17W99010	N765	✓	135
056T1105301	X501	✓	179	056T17D11048	G244A	✓	46	056T17F15917	K472	✓	108	056T17W99015	N646A	✓	123
056T1105302	X502	✓	179	056T17D11049	G047A	✓	39	056T17F15918	K465	✓	108	056T17W99016	N602A	✓	124
056T1105303	X503	✓	179	056T17D11050	K248A	✓	46	056T17F15919	K438	✓	108	056T17W99018	N649A	✓	123
056T1105304	X509	✓	179	056T17D11051	G046A	✓	39	056T17F15920	K436	✓	108	056T17W99020	N611A	✓	124
056T1105305	X513	✓	178	056T17D11052	K1305A	✓	47	056T17F15921	K455	✓	108	056T17W99021	K608A	✓	123
056T1105306	X523	✓	178,203	056T17D11053	K247A	✓	46	056T17F99014	K1494A	✓	108	056T17W99022	N653A	✓	73
056T1105307	X524	✓	179	056T17D11055	G084A	✓	39	056T17F99015	K459A	✓	108	056T17W99023	K610A	✓	73
056T1105308	X522	✓	179	056T17D115528	K081	✓	39	056T17G5312	G649	✓	84	056T17W99024	K609A	✓	73
056T1105309	X526	✓	179	056T17D15715	K041A	✓	40	056T17G5313	G661	✓	84	056T17W99025	N326	✓	122
056T1105310	X525	✓	178,203	056T17D15716	K062A	✓	40	056T17G5314	G663	✓	84	056T17W99028	N468B	✓	131
056T11011001	X532	✓	178	056T17D15717	K648A	✓	47	056T17G5315	G829	✓	85	056T17W99029	N293A	✓	132
056T11011002	X533	✓	178	056T17D15718	K644A	✓	46	056T17G5316	G840	✓	85	056T17W99030	N765A	✓	135
056T11011005	X533-P	✓	178	056T17D15906	K250A	✓	46	056T17G5318	G844	✓	85	056T17W99031	N770A	✓	135
056T110115511	X512	✓	178	056T17D15907	K1308A	✓	47	056T17G5319	G845	✓	85	056T17W99032	N720A	✓	135
056T11015569	X523-P	✓	178	056T17D15908	G063A	✓	39	056T17G5321	G666	✓	84	056T17W99033	N294A	✓	132
056T11015571	X502-P	✓	179	056T17D15909	K249A	✓	46	056T17G5322	G667	✓	84	056T17W99034	N470B	✓	131
056T11015572	X512-P	✓	178	056T17D15910	K1307A	✓	47	056T17G15598	G668A	✓	84	056T17W99035	N627A	✓	124
056T11015573	X513-P	✓	178	056T17D15911	K022A	✓	40	056T17G15599	G841A	✓	85	056T17W99036	N711A	✓	135
056T11015574	X501-P	✓	179	056T17D15912	K521A	✓	46	056T17G15600	G663A	✓	84	056T17W99037	N464B	✓	131
056T11015575	X500-P	✓	179	056T17D15913	K061A	✓	40	056T17G15601	K2115A	✓	85	056T17W99038	N761A	✓	135
056T11V5376	N568	✓	124	056T17D15914	K646A	✓	47	056T17G15602	K2111A	✓	84	056T17W99039	N291A	✓	132
056T11V5377	N600	✓	124	056T17D15915	K004A	✓	39	056T17G15615	G846A	✓	85	056T17W99040	N465B	✓	131
056T11V5379	N180A	✓	132	056T17D15916	K251A	✓	46	056T17T5305	G580	✓	60	056T17W99041	N402A	✓	132
056T11V5380	N181A	✓	132	056T17D15917	K635A	✓	47	056T17T5316	K703	✓	60	056T17W99044	N606A	✓	124
056T11V5385	N495	✓	129	056T17D15945	K203	✓	47	056T17V5326	N640	✓	123	056T17W99045	N715A	✓	135
056T11V5387	N426	✓	128	056T17DRR70010A1	G921A	✓	39	056T17V5327	N641	✓	123	056T17W99046	N383	✓	126
056T11V5379	N427	✓	128	056T17DRR70011A1	G923A	✓	40	056T17V5328	N642	✓	123	056T17W99047	N363	✓	126
056T11W5377	N604	✓	124	056T17DRR70021A1	G905A	✓	39	056T17V5329	N644	✓	123	056T17WD5328	N417	✓	129
056T11W5379	N182A	✓	132	056T17DRR70023A1	G908A	✓	39	056T17V5331	N649	✓	123	056T17WD5329	N415	✓	129
056T11W5380	N183A	✓	132	056T17E5308	G646	✓	84	056T17V5332	N564	✓	124	056T17WD5331	N435	✓	128
056T11W99003	N604A	✓	124	056T17E5309	G647	✓	84	056T17V5336	N567	✓	124	056T17WD5332	N437	✓	128
056T11W99004	N182B	✓	132	056T17E5310	G827	✓	85	056T17V5337	N622	✓	124	056T17WD5337	N496	✓	129
056T11WD5379	N429	✓	128	056T17E5311	G828	✓	85	056T17V5338	N599	✓	124	056T17WD5338	N494	✓	129
056T11WD5386	N497	✓	129	056T17E5312	G842	✓	85	056T17V5342	N606	✓	124	056T17WD15329	N415A	✓	129
056T11WD5387	N498	✓	129	056T17E5313	G843	✓	85	056T17V5347	N400	✓	132	056T17WD15328	N417A	✓	129
056T17D2092	K004	✓	39	056T17E5314	G664	✓	84	056T17V5348	N401	✓	132	056T17WD15330	N433A	✓	128
056T17D2099	G101	✓	196	056T17E5315	G665	✓	84	056T17V5349	N402	✓	132	056T17WD15331	N435A	✓	128
056T17D2101	G100	✓	196	056T17F2043	G304	✓	52	056T17V5352	N463A	✓	131	056T17WD15332	N437A	✓	128
056T17D2104	G106	✓	196	056T17F2045	G328	✓	53	056T17V5353	N462A	✓	131	056T17WD15336	N419A	✓	129
056T17D2110	G086	✓	39	056T17F2047	K405	✓	58	056T17V5354	N388	✓	133	056T34D5303	K009	✓	40
056T17D2112	G065	✓	39	056T17F2051	G565	✓	60	056T17V15501	N620A	✓	124	056T34D5304	K025	✓	40
056T17D2116	G243	✓	46	056T17F5302	G347	✓	53	056T17V99002	N375	✓	126	056T34D5326	G241	✓	46
056T17D2117	G964	✓	196	056T17F5321	G581	✓	60	056T17V99003	N371	✓	126	056T34D5327	G205	✓	46
056T17D2118	G961	✓	196	056T17F5322	G582	✓	60	056T17V99004	N373	✓	126	056T34D5340	K048	✓	41
056T17D2119	G962	✓	196	056T17F5324	G584	✓	61	056T17V99006	N351	✓	126	056T34D5357	B193	✓	196
056T17D2120	G963	✓	196	056T17F5336	K705	✓	60	056T17V99007	N353	✓	126	056T34D5364	X251	✓	196,208
056T17D2121	G162	✓	196	056T17F5337	K707	✓	60	056T17V99008	N355	✓	126	056T34D5365	J049	✓	140
056T17D2130	K049	✓	39	056T17F5339	K722	✓	61	056T17V99009	N377	✓	126	056T34D5366	J050	✓	140
056T17D3301	K063	✓	39	056T17F5348	D450	✓	109	056T17V99011	N708	✓	135	056T34D5367	J048	✓	140
056T17D3302	K064	✓	40	056T17F5349	D452	✓	109	056T17V99013	N761	✓	135	056T34D5368	J047	✓	140
056T17D3303	K065	✓	40	056T17F5350	D454	✓	109	056T17V99014	N758	✓	135	056T34D5369	J051	✓	140
056T17D3304	K066	✓	41	056T17F5357	D456	✓	109	056T17V99015	N755	✓	135	056T34D5370	J052	✓	140
056T17D3305	K067	✓	39	056T17F5358	D457	✓	109	056T17V99016	N705	✓	135	056T34D5371	J053	✓	140
056T17D3306	K068	✓	40	056T17F15639	G583A	✓	60	056T17V99029	N389B	✓	133	056T34D6001	U244	✓	39
056T17D3307	K069	✓	40	056T17F15640	G585A	✓	61	056T17V5326	N410	✓	129	056T34D15593	G080A	✓	39
056T17D3308	K080	✓	41	056T17F15641	G584A	✓	61	056T17V5327	N412	✓	129	056T34D15594	G205A	✓	46
056T17D5309	K022	✓	40	056T17F15642	K709A	✓	60	056T17V5328	N411	✓	129	056T34D15595	K027A	✓	39
056T17D5310	K041	✓	40	056T17F15644	K724A	✓	61	056T17V5329	N430	✓	128	056T34D15596	K048A	✓	41
056T17D5329	G122	✓	196	056T17F15645	K722A	✓	61	056T17V5330	N431	✓	128	056T34D15597	G289A	✓	46
056T17D5332	G127	✓	196	056T17F15646	K806A	✓	61	056T17V5331	N432	✓	128	056T34D15598	K025A	✓	40
056T17D5344	G923	✓	40	056T17F15655	D456A	✓	109	056T17V5332	N428A	✓	128	056T34D15600	K000A	✓	39
056T17D5345	G140	✓	196	056T17F15657	G541A	✓	58	056T17W5329	N291	✓	132	056T34D15599	K009A	✓	40
056T17D5346	G141	✓	196	056T17F15658	G563A	✓	60	056T17W5330	N468	✓	131	056T34D15601	K690A	✓	47
056T17D5347	G142	✓	196	056T17F15659	K1438B	✓	118	056T17W5331	N465A	✓	131	056T34D15602	K1311A	✓	47
056T17D5348	G143	✓	196	056T17F15660	G527A	✓	58	056T17W5334	N6						

MODEL NO.	CAT. NO.	STOCK	PAGE NO.	MODEL NO.	CAT. NO.	STOCK	PAGE NO.	MODEL NO.	CAT. NO.	STOCK	PAGE NO.	MODEL NO.	CAT. NO.	STOCK	PAGE NO.
056T34F5322	P103	✓	58,141	056T34W99009	N228	✓	125	080T17V5326	R701	✓	134	143C17DRR40001A1	C188A	✓	24
056T34F5328	G308	✓	52	056T34W99008	N236	✓	125	080T17V5327	R710	✓	134	143TBRFS301	I220	✓	30
056T34F5333	G309	✓	52	056T34W99010	N232	✓	125	080T17V5328	R721	✓	134	143TBRFS376	I707	✓	30
056T34F5334	G327	✓	53	056T34W99011	N234	✓	125	080T17V5329	R723	✓	134	143TCDRS303	I101	✓	25
056T34F5342	J061	✓	141	056T34W99016	N622A	✓	123	080T17V5330	R730	✓	134	143TCDRS328	Z401	✓	144
056T34F5343	J062	✓	141	056T34W99017	N228A	✓	125	080T17V5331	R703	✓	134	143TCDRS330	Z420	✓	145
056T34F5344	J063	✓	141	056T34W99018	N234A	✓	125	080T17V5332	R731	✓	134	143TCFRS328	Z123	✓	110
056T34F5345	J064	✓	141	056T34W99019	N236A	✓	125	080T17V5333	R711	✓	134	143TCWR17031	N685	✓	121
056T34F5346	J065	✓	141	056T34W99020	N651A	✓	123	080T17W5326	R704	✓	134	143THEN8034	Y978	✓	96
056T34F5348	K704	✓	60	056T34W99021	N224A	✓	125	080T17W5327	R712	✓	134	143THN8028	Y525	✓	95
056T34F5349	K706	✓	60	056T34W99022	N609A	✓	124	080T17W5328	R724	✓	134	143THN8036	Y986	✓	97
056T34F5940	E2000	✓	62	056T34W99023	N226A	✓	125	080T17W5329	R732	✓	134	143THN9001	W505	✓	79
056T34F15591	P107A	✓	59,141	056T34W99024	N238A	✓	125	080T34FH5301	R312	✓	104	143THN9005	W506	✓	79
056T34F15592	J065A	✓	141	056T805301	X506	✓	179	080T34FH5302	R315	✓	104	143THN9026	W501	✓	79
056T34F15593	K725A	✓	61	056T805302	X507	✓	179,203	080T34FH5303	R415	✓	104	143THN19033	W502	✓	79
056T34F15597	K240A	✓	141	056T805303	X511	✓	179	080T34FH5305	R412	✓	104	143THRS326	Y536	✓	93
056T34F15598	K500A	✓	60	056T805304	X529	✓	179	080T34FH5413	R372	✓	106	143THR15535	Y283	✓	92
056T34F15600	P106A	✓	59,141	056T805306	X528	✓	178,203	080T34FH5416	R375	✓	106	143TDRS376	H150	✓	39
056T34F15601	J066A	✓	141	056T805307	X530	✓	179	080T34FH5513	R392	✓	106	143TDRS401	H180	✓	39
056T34F15619	G363A	✓	53	056T805531	X529	✓	178,203	080T34FH5516	R395	✓	106	143TDR6007	GT0403	✓	146
056T34F15623	G368A	✓	54	056T8015504	X531	✓	178,203	080T34FH15301	R312A	✓	104	143TDR6008	GT0503	✓	146
056T34F15636	G383A	✓	53	056T8015529	X528-P	✓	178	080T34FH15305	R412A	✓	104	143TDR6027	U758	✓	40
056T34F15940	E2100	✓	53	056T8015530	X529-P	✓	178	080T34FH15413	R372A	✓	106	143TDR6028	U245	✓	40
056T34F16001	E2150	✓	53	056T8015531	X506-P	✓	179	080T34FH15513	R392A	✓	106	143TDR6030	GT0401	✓	146
056T34F16020	E2125	✓	53	056T8015532	X507-P	✓	179	090LT17FH6326	R319A	✓	105	143TDR6031	GT0501	✓	146
056T34F99009	P104A	✓	58,141	056T8015533	X530-P	✓	179	090LT17FH6327	R419A	✓	105	143TDR6051	U418A	✓	39
056T34F99008	D393A	✓	60	056T8015534	X531-P	✓	178	090LT17FH6419	R378A	✓	106	143TDR6052	U417A	✓	39
056T34F99010	K708A	✓	60	063T17FH5326	R401	✓	104	090LT17FH6519	R398A	✓	106	143TDR6313	E783A	✓	40
056T34F99012	D395A	✓	61	063T17FH5327	R301	✓	104	090LT17W4027	R706	✓	134	143TDR14049	K634A	✓	46
056T34F99014	D396A	✓	61	063T17FH5402	R361	✓	106	090LT17W4028	R707	✓	134	143TDR16005	E798A	✓	40
056T34F99015	K723A	✓	61	063T17FH5502	R381	✓	106	090LT17W6026	R705A	✓	134	143TDR16006	GT2503	✓	146
056T34F99017	D394A	✓	61	063T34FH5301	R300	✓	104	090LT17W6027	R706A	✓	134	143TDR16007	GT4203	✓	154
056T34F99018	J064A	✓	141	063T34FH5302	R303	✓	104	090LT17W6028	R707A	✓	134	143TDR16008	GT4503	✓	154
056T34F99020	K721A	✓	61	063T34FH5303	R400	✓	105	090LT34FH6301	R321A	✓	105	143TDR16009	GT2003	✓	146
056T34F99021	KG237A	✓	59	063T34FH5304	R403	✓	104	090LT34FH6302	R421A	✓	105	143TDR16010	GT2303	✓	146
056T34F99023	KG234A	✓	141	063T34FH5401	R360	✓	106	090LT34FH6420	R379A	✓	106	143TDR16011	GT4303	✓	154
056T34F99028	K238A	✓	141	063T34FH5404	R363	✓	106	090LT34FH6520	R399A	✓	106	143TDR16012	GT4003	✓	146
056T34F99029	J063A	✓	141	063T34FH5501	R380	✓	106	090ST11FH6376	R314A	✓	104	143TDR16013	GT4103	✓	146
056T34F99030	K233A	✓	58	063T34FH5504	R383	✓	106	090ST11FH6415	R374A	✓	106	143TDR16014	GT4403	✓	154
056T34F99031	KG236A	✓	141	071T11FH5376	R302	✓	104	090ST11FH6515	R394A	✓	106	143TDR16015	GT2403	✓	154
056T34F99032	P105A	✓	58,141	071T11FH5403	R362	✓	106	090ST17FH6326	R316A	✓	104	143TDR16021	K2018A	✓	46
056T34G5303	G648	✓	84	071T11FH5503	R382	✓	106	090ST17FH6327	R416A	✓	104	143TDR16024	E917A	✓	40
056T34G5304	G660	✓	84	071T17FH5326	R304	✓	104	090ST17FH6417	R376A	✓	106	143TDR16035	U416A	✓	39
056T34G15577	G662A	✓	84	071T17FH5327	R307	✓	104	090ST17FH6517	R396A	✓	106	143TDR16036	U922A	✓	146
056T34T5303	D390	✓	60	071T17FH5330	R404	✓	104	090ST34FH6301	R318A	✓	105	143TDR16037	E912A	✓	40
056T34T5306	P101	✓	58,141	071T17FH5331	R407	✓	104	090ST34FH6302	R418A	✓	105	143TDR16039	GT4201	✓	146
056T34T5308	J060	✓	141	071T17FH5405	R364	✓	106	090ST34FH6418	R377A	✓	106	143TDR16040	GT2501	✓	154
056T34T5309	K702	✓	60	071T17FH5408	R367	✓	106	090ST34FH6518	R397A	✓	106	143TDR16041	GT4501	✓	154
056T34V5301	N643	✓	123	071T17FH5505	R384	✓	106	100LTC6501	R351A	✓	105	143TDR16042	GT4001	✓	146
056T34V5302	N645	✓	123	071T17FH5508	R387	✓	106	100LTC6502	R451A	✓	105	143TDR16043	GT2001	✓	146
056T34V5303	N648	✓	123	071T17V5326	R700	✓	134	100LTC6526	R322A	✓	105	143TDR16044	GT2301	✓	154
056T34V5305	N566	✓	124	071T17V5327	R702	✓	134	100LTC6527	R422A	✓	105	143TDR16045	GT4301	✓	154
056T34V5306	N569	✓	124	071T17V5328	R720	✓	134	100LTC6536	R352A	✓	105	143TDR16046	GT4204	✓	146
056T34V5307	N601	✓	124	071T17V5329	R722	✓	134	100LTC6537	R452A	✓	105	143TDR16047	GT4101	✓	146
056T34V5308	N605	✓	124	071T34FH5301	R306	✓	104	100LTC6576	R320A	✓	105	143TDR16048	GT2401	✓	154
056T34V5312	N440A	✓	132	071T34FH5302	R309	✓	104	100LTC6577	R420A	✓	105	143TDR16049	GT4401	✓	154
056T34V5313	N482A	✓	131	071T34FH5303	R406	✓	104	100LTC6586	R317	✓	104	143TDR16052	U758-P	✓	40
056T34V5314	N439A	✓	132	071T34FH5304	R409	✓	104	111A271P113	A965	✓	246	143TDR16055	E927A	✓	39
056T34V5315	N441A	✓	132	071T34FH5407	R366	✓	106	112A515AKG4	AG228	✓	247	143TDR16056	E901A	✓	39
056T34V5316	N480A	✓	131	071T34FH5410	R369	✓	106	112A515ASG2	AG229	✓	247	143TDR16057	K634B	✓	46
056T34V5317	N481A	✓	131	071T34FH5507	R386	✓	106	112MTC6511	R324A	✓	105	143TDR16068	K2021A	✓	47
056T34V99001	N665	✓	123	071T34FH5510	R389	✓	106	112MTC6512	R424A	✓	105	143TFR6501	E377	✓	75
056T34V99002	N667	✓	123	080T11FH5376	R305	✓	104	112MTC6536	R325A	✓	105	143TFR6502	E378	✓	75
056T34V99011	N710	✓	135	080T11FH5377	R308	✓	104	112MTC6537	R425A	✓	105	143TFR6505	E379	✓	75
056T34V99012	N753	✓	135	080T11FH5378	R311	✓	104	112MTC6576	R323A	✓	105	143TFR6526	E374	✓	75
056T34V99013	N703	✓	135	080T11FH5406	R365	✓	106	113A617AG001	A948	✓	250	143TFR6563	E375	✓	75
056T34V99014	N707	✓	135	080T11FH5409	R368	✓	106	113A620AYP1	A949	✓	250	143TFR6576	E373	✓	75
056T34V99015	N757	✓	135	080T11FH5412	R371	✓	106	115D963P1	A947	✓	250	143TFR8076	H457	✓	53
056T34V99016	N760	✓	135	080T11FH5506	R385	✓	106	115D964P1	A945	✓	250	143TFR16008	E596	✓	53
056T34VD5301	N450	✓	129	080T11FH5509	R388	✓	106	115D964P2	A946	✓	250	143TFR16040	E2201-P	✓	53
056T34VD5302	N451	✓	129	080T11FH5512	R391	✓	106	132MTC6536	R331A	✓	105	143TFR16539	E376	✓	75
056T34VD5303	N452	✓	129	080T17FH5326	R310	✓	104	132MTC6537	R431A	✓	105	143TFR4028	E824	✓	53
056T34VD5301	N453	✓	129	080T17FH5330	R410	✓	104	132MTC6586	R326A	✓	105	143TFR4329	C220A	✓	58
056T34WD15302	N455A	✓	129	080T17FH5331	R413	✓	104	132MTC6587	R329A	✓	105	143TFR5302	C201	✓	58
056T34WD15303	N457A	✓	129	080T17FH5411	R370	✓	106	132STFC6501	R327A	✓	105	143TFR5376	H700	✓	53
056T34W99002	N631	✓	124	080T17FH5414	R373	✓	106	132STFC6502	R330A	✓	105	143TFR5582	E2003	✓	62
056T34W99003	N220	✓	125	080T17FH5511	R390	✓	106	132STFC6503	R427A	✓	105	143TFR6010	GT1203		

Index

Model Number/Catalog Number

INDEX

MODEL NO.	CAT. NO.	STOCK	PAGE NO.	MODEL NO.	CAT. NO.	STOCK	PAGE NO.	MODEL NO.	CAT. NO.	STOCK	PAGE NO.	MODEL NO.	CAT. NO.	STOCK	PAGE NO.
143TFR16003	GT1403	✓	70	143TWR14002	N202	✓	125	145TDR6034	GT0404	✓	146	145TFN6521	E383	✓	76
143TFR16004	GT5203	✓	150	143TWR14031	N203	✓	125	145TDR6036	GT0407	✓	146	145TFN16045	E2207-P	✓	54
143TFR16005	GT5003	✓	150	143TWR14032	N201	✓	125	145TDR6039	U246	✓	40	145TFN16046	E2204-P	✓	53
143TFR16006	GT5103	✓	150	143TWR16026	N647A	✓	123	145TDR6076	U265	✓	40	145TFN16081	E355	✓	53
143TFR16007	GT3003	✓	150	143TWR16027	N203A	✓	125	145TDR6126	U420A	✓	40	145TFN16082	U699	✓	53
143TFR16008	GT5303	✓	158	143TWR16028	N310A	✓	122	145TDR6127	U421A	✓	40	145TFN16592	E499	✓	75
143TFR16009	GT3303	✓	158	143TWR16029	N201A	✓	125	145TDR6132	U423A	✓	40	145TFN16593	E858	✓	75
143TFR16010	GT3103	✓	150	143TWR16030	N650A	✓	123	145TDR6133	U424A	✓	40	145TFN16632	E386A	✓	76
143TFR16011	GT3403	✓	158	143TWR16031	N384	✓	126	145TDR14007	C102A	✓	46	145TFR3002	E2006	✓	62
143TFR16012	GT5403	✓	158	145TDR5302	I102	✓	25	145TDR14049	K622A	✓	46	145TFR4029	E836	✓	53
143TFR16013	GT3203	✓	150	145TDR5303	I145	✓	27	145TDR14088	C150A	✓	46	145TFR4306	C202A	✓	59
143TFR16014	GT5503	✓	158	145TDR5304	Z404	✓	144	145TDR16008	U906A	✓	40	145TFR4332	C221A	✓	58
143TFR16015	GT3503	✓	158	145TDR5309	Z304	✓	117	145TDR16010	E932A	✓	41	145TFR4378	C250A	✓	58
143TFR16017	C201B	✓	58	145TDR5337	I127	✓	25,216,223	145TDR16013	GT4006	✓	146	145TFR5359	C403	✓	109
143TFR16020	E2128	✓	53	145TDR5345	I147	✓	191	145TDR16014	GT2306	✓	154	145TFR5360	C401	✓	109
143TFR16032	GT3101	✓	150	145TDR5301	I204	✓	31	145TDR16015	GT2006	✓	146	145TFR6009	GT1206	✓	70
143TFR16038	E2151	✓	53	145TDR5302	I205	✓	31	145TDR16016	GT4506	✓	154	145TFR6040	GT1207	✓	70
143TFR16039	GT1401	✓	70	145TDR5303	I221	✓	31	145TDR16017	GT2506	✓	154	145TFR6058	GT1204	✓	70
143TFR16040	E2126	✓	53	145TDR5305	C282	✓	34	145TDR16018	GT4206	✓	146	145TFR6078	E2002	✓	62
143TFR16042	GT5201	✓	150	145TDR5306	C284	✓	34	145TDR16019	GT4106	✓	146	145TFR13002	E2106	✓	54
143TFR16043	GT5401	✓	158	145TDR5309	T031	✓	225	145TDR16020	GT2406	✓	154	145TFR15581	E2152	✓	53
143TFR16044	GT3501	✓	158	145TDR5327	I201	✓	30	145TDR16021	GT4406	✓	154	145TFR16001	E2156	✓	54
143TFR16045	GT5501	✓	158	145TDR5328	Z118	✓	110	145TDR16022	GT4009	✓	147	145TFR16005	GT1406	✓	70
143TFR16046	GT3201	✓	150	145TDR5333	I311	✓	224	145TDR16023	GT2009	✓	147	145TFR16009	GT5006	✓	150
143TFR16047	GT3001	✓	150	145TDR5334	I700	✓	31	145TDR16024	GT2309	✓	154	145TFR16010	GT3006	✓	150
143TFR16048	GT5001	✓	150	145TDR5336	I702	✓	224	145TDR16025	GT4309	✓	154	145TFR16011	GT5306	✓	158
143TFR16049	GT3301	✓	158	145TDR5337	C281	✓	34	145TDR16054	U923A	✓	40	145TFR16012	GT5106	✓	150
143TFR16050	GT5301	✓	158	145TDR5341	Z128	✓	110	145TDR16056	U422A	✓	40	145TFR16013	GT3106	✓	150
143TFR16051	GT3401	✓	158	145TDR5301	N288	✓	130	145TDR16059	U924A	✓	40	145TFR16014	GT3406	✓	158
143TFR16052	GT5101	✓	150	145TDR5305	N348	✓	127	145TDR16061	E913A	✓	40	145TFR16015	GT5406	✓	158
143TFR16053	E2001A	✓	62	145TDR5326	N275	✓	130	145TDR16062	E914A	✓	40	145TFR16016	GT3306	✓	158
143TFR16059	C220B	✓	58	145TDR5327	N274	✓	130	145TDR16077	E934A	✓	40	145TFR16017	GT5206	✓	150
143TFR16065	K461A	✓	108	145TDR5328	N289	✓	130	145TDR16073	GT4004	✓	146	145TFR16018	GT3206	✓	150
143TFR16066	K462A	✓	108	145TDR5329	N287	✓	130	145TDR16074	GT2004	✓	146	145TFR16019	GT5506	✓	158
143TFR16070	C230B	✓	58	145TDR5335	N349	✓	127	145TDR16075	GT2304	✓	154	145TFR16020	E2131	✓	54
143TGN6501	U058A	✓	86	145TDR5328	Z403	✓	144	145TDR16079	GT2402	✓	154	145TFR16021	GT3506	✓	158
143TGN6526	U001A	✓	86	145TDR5329	Z422	✓	145	145TDR16080	GT0402	✓	146	145TFR16033	E2104	✓	53
143TGN6530	U020A	✓	86	145TDR5331	I146	✓	191	145TDR16081	GT0502	✓	146	145TFR16035	E2107	✓	54
143TGN6532	U986A	✓	86	145TDR5326	N683	✓	121	145TDR16082	GT2502	✓	154	145TFR16036	GT3104	✓	150
143TGN6551	C361A	✓	83	145TDR5326	Z615	✓	100	145TDR16085	C150B	✓	46	145TFR16037	GT3107	✓	151
143TGN7076	H350	✓	86	145TDR5327	Z616	✓	100	145TDR16089	E785A	✓	40	145TFR16038	E2154	✓	53
143TGN14011	C301B	✓	85	145TDR8034	Y979	✓	96	145TDR16301	GT2409	✓	154	145TFR16039	E2157	✓	54
143TGN16539	C320B	✓	85	145TDR5326	Y523	✓	91	145TDR16302	GT4209	✓	147	145TFR16040	E2129	✓	53
143TGR16001	I506	✓	84	145TDR5329	Y368	✓	91	145TDR16303	GT2509	✓	154	145TFR16045	E2132	✓	54
143TGR16005	I507	✓	84	145TDR5330	Y369	✓	91	145TDR16304	GT4509	✓	154	145TFR16046	GT1404	✓	70
143TGR16026	I502	✓	84	145TDR16046	Y551	✓	93	145TDR16305	GT4109	✓	147	145TFR16047	GT1407	✓	70
143TGR16030	I503	✓	84	145TDR16060	Y557	✓	93	145TDR16306	GT4409	✓	154	145TFR16055	GT5407	✓	159
143TTN4005	E835	✓	53	145TDR8029	Y526	✓	95	145TDR16307	GT4306	✓	154	145TFR16056	GT3407	✓	159
143TTN6001	E351	✓	53	145TDR8037	Y590	✓	95	145TDR16308	U401A	✓	47	145TFR16057	GT5107	✓	151
143TTN6026	E349	✓	53	145TDR8043	Y987	✓	97	145TDR16319	C103A	✓	46	145TFR16058	GT5004	✓	150
143TTN6030	E300	✓	53	145TDR9001	W511	✓	79	145TDR16326	GT4304	✓	154	145TFR16059	GT3004	✓	150
143TTN6501	E651	✓	75	145TDR17034	Y285	✓	92	145TDR16327	GT2504	✓	154	145TFR16060	GT3304	✓	158
143TTN6502	E463	✓	75	145TDR19002	W512	✓	79	145TDR16328	GT4504	✓	154	145TFR16061	GT5304	✓	158
143TTN6505	E851	✓	75	145TDR19058	W513A	✓	79	145TDR16329	GT4104	✓	146	145TFR16062	GT5204	✓	150
143TTN6526	E649	✓	75	145TDR19059	W507A	✓	79	145TDR16330	GT2404	✓	154	145TFR16063	GT3204	✓	150
143TTN6530	E666	✓	75	145TDR5326	Y538	✓	93	145TDR16331	GT4404	✓	154	145TFR16064	GT3504	✓	158
143TTN6563	E461	✓	75	145TDR5328	Y522	✓	91	145TDR16332	GT4107	✓	146	145TFR16065	GT5504	✓	158
143TTN6576	E648	✓	75	145TDR5329	Y366	✓	91	145TDR16333	GT2407	✓	154	145TFR16066	GT5007	✓	151
143TTN16041	E825A	✓	53	145TDR5330	Y367	✓	91	145TDR16334	GT4407	✓	154	145TFR16067	GT3007	✓	151
143TTV5327	N466	✓	131	145TDR5376	Y537	✓	93	145TDR16335	GT2007	✓	146	145TFR16068	GT3307	✓	159
143TTV5330	N378	✓	126	145TDR15540	Y284	✓	92	145TDR16336	GT4007	✓	146	145TFR16069	GT5307	✓	159
143TTV16026	N358A	✓	126	145TDR16031	Y611	✓	93	145TDR16337	GT2307	✓	154	145TFR16070	GT5207	✓	151
143TTV4002	N456	✓	129	145TDR16032	Y612	✓	93	145TDR16338	GT4207	✓	146	145TFR16071	GT3207	✓	151
143TTV4527	N434A	✓	128	145TDR4134	U422	✓	40	145TDR16339	GT2507	✓	154	145TFR16072	GT3507	✓	159
143TTV6001	N454A	✓	129	145TDR5401	H181	✓	39	145TDR16340	GT4507	✓	154	145TFR16073	GT5507	✓	159
143TTV6002	N456A	✓	129	145TDR5647	H952	✓	225	145TDR16342	GT4307	✓	154	145TFR16074	GT5104	✓	150
143TTV6026	N414A	✓	129	145TDR5701	Y465	✓	218	145TDR16348	U759-P	✓	40	145TFR16075	GT5404	✓	158
143TTV60527	N434B	✓	128	145TDR5702	Y466	✓	218	145TDR16349	U760-P	✓	40	145TFR16079	GT1202	✓	70
143TTV16002	N442A	✓	132	145TDR5703	Y449	✓	218	145TDR16351	E928A	✓	40	145TFR16078	E2102	✓	53
143TTV16003	N763	✓	135	145TDR5704	Y450	✓	218	145TDR16352	E929A	✓	40	145TFR16080	E2127	✓	53
143TTV16004	N713	✓	135	145TDR5705	Y451	✓	218	145TDR16355	E902A	✓	40	145TFR16083	GT3102	✓	150
143TTV16005	N483A	✓	131	145TDR5706	Y452	✓	218	145TDR16356	E903A	✓	40	145TFR16084	GT3402	✓	158
143TTV16006	N152A	✓	133	145TDR6002	U247	✓	41	145TDR16359	C122B	✓	46	145TFR16085	GT3202	✓	150
143TTV16031	N292	✓	132	145TDR6004	GT0506	✓	146	145TDR16360	K622B	✓	46	145TFR16086	GT3502	✓	158
143TTV16032	N766	✓	135	145TDR6006	GT0509	✓	147	145TDR16365	K2022A	✓	47	145TFR16088	C250B	✓	58
143TTV16033	N716	✓	135	145TDR6007	GT0406	✓	146	145TDR16366	K2023A	✓	47	145TFR16092	C400A	✓	109
143TTV16036	N467A	✓	131	145TDR6013	GT0409	✓	147	145TDR16403	C102B	✓	46	145TFR16095	K473	✓	108
143TTV16037	N466A	✓	131	145TDR6028	U759	✓	40	145TDR16441	U419A	✓	40	145TFR16096	K2		

MODEL NO.	CAT. NO.	STOCK	PAGE NO.	MODEL NO.	CAT. NO.	STOCK	PAGE NO.	MODEL NO.	CAT. NO.	STOCK	PAGE NO.	MODEL NO.	CAT. NO.	STOCK	PAGE NO.
145TFR16326	GT3404	✓	158	145TTWD16035	N153A	✓	133	182TEFR5326	Z617	✓	100	182TTFB6033	GT3210	✓	151
145TFR16329	E2007A	✓	62	145TTWD16036	N471A	✓	131	182THES8048	Y980	✓	96	182TTFB6037	GT3410	✓	159
145TFR16331	E2004A	✓	62	145TTWD16037	N155A	✓	133	182THFR5329	Y370	✓	92	182TTFB6038	GT3510	✓	159
145TFR16353	C221B	✓	58	145TWR4301	N655A	✓	123	182THFR5330	Y371	✓	92	182TTFB6078	GT1205	✓	70
145TFR16359	C403A	✓	109	145TWR6001	N613A	✓	124	182THFS19101	W504	✓	79	182TTFB6079	GT1305	✓	69
145TFR16360	C401A	✓	109	145TWR6026	N612A	✓	124	182THFW7729	Y1999	✓	92	182TTFB6082	GT3105	✓	150
145TFR16361	K2045A	✓	108	145TWR6027	N312A	✓	122	182THFW7730	Y270A	✓	92	182TTFB6085	GT3405	✓	158
145TFR16362	K2046A	✓	108	145TWR6029	N321A	✓	122	182HTL7736	Y558	✓	93	182TTFB6092	GT3205	✓	150
145TFR16374	C231B	✓	58	145TWR6033	N630	✓	124	182HTS8028	Y527	✓	95	182TTFB6095	GT3505	✓	158
145TFR16426	C232B	✓	59	145TWR6076	N323	✓	122	182HTS8048	Y988	✓	97	182TTFB6003	GT1209A	✓	70
145TFR16429	K476	✓	108	145TWR14003	N204	✓	125	182HTS9001	W517	✓	80	182TTFB6004	GT1309A	✓	69
145TFR16430	K474	✓	108	145TWR14004	N206	✓	125	182HTS9026	W519	✓	80	182TTFB6007	GT1409A	✓	70
145TFR16431	K441	✓	108	145TWR14031	N205	✓	125	182HTS9076	W509	✓	79	182TTFB6029	GT1310A	✓	69
145TFR17033	C222A	✓	59	145TWR14032	N360	✓	126	182HTS19033	W520	✓	80	182TTFB6032	GT1410A	✓	70
145TTGN6501	U059A	✓	86	145TWR14033	N362	✓	126	182HTY7726	Y541A	✓	93	182TTFB6078	GT1205A	✓	70
145TTGN6526	U002A	✓	86	145TWR16002	N324	✓	122	182HTY7736	Y558A	✓	93	182TTFB6079	GT1305A	✓	69
145TTGN6527	U003A	✓	86	145TWR16003	N610A	✓	124	182HTY17041	Y286A	✓	92	182TTFB6030	GT1009	✓	63
145TTGN6536	C362A	✓	83	145TWR16005	N655B	✓	123	182TPFRB10181	SY036	✓	99	182TTFB6005	GT1109	✓	63
145TTGN6537	U021A	✓	86	145TWR16006	N206A	✓	125	182TPFRB10194	SY066	✓	99	182TTFB6026	GT1010	✓	64
145TTGN6540	U022A	✓	86	145TWR16007	N204A	✓	125	182TPNSB10237	SY006A	✓	99	182TTFB6026	GT1110	✓	64
145TTGN6549	C363A	✓	83	145TWR16008	N652A	✓	123	182TTDB6001	GT0012	✓	48	182TTFB6031	U609A	✓	54
145TTGN6550	U988A	✓	86	145TWR16026	N607A	✓	124	182TTDB6007	GT0412	✓	147	182TTFB6076	GT1005	✓	63
145TTGN6576	U039A	✓	86	145TWR16028	N654B	✓	123	182TTDB6008	GT0512	✓	147	182TTFB6080	GT1105	✓	63
145TTGN16034	C322B	✓	85	145TWR16029	N629A	✓	124	182TTDB6012	GT2412	✓	155	182TTFB6001	GT1009A	✓	63
145TTGN16036	C321B	✓	85	145TWR16030	N205A	✓	125	182TTDB6013	GT2512	✓	155	182TTFB6005	GT1109A	✓	64
145TTGN16504	C302B	✓	85	145TWR16031	N380A	✓	126	182TTDB6026	GT0010	✓	48	182TTFB6026	GT1010A	✓	64
145TTGN16532	U987A	✓	86	145TWR16032	N382A	✓	126	182TTDB6032	GT0410	✓	147	182TTFB6030	GT1110A	✓	64
145TGR16002	I512	✓	84	145TWR16033	N360A	✓	126	182TTDB6033	GT0510	✓	147	182TTFB6076	GT1005A	✓	63
145TGR16004	I513	✓	84	145TWR16034	N362A	✓	126	182TTDB6037	GT2410	✓	155	182TTFB6080	GT1105A	✓	63
145TGR16030	I509	✓	84	145TWR17032	N382	✓	126	182TTDB6038	GT2510	✓	155	182TFN6557	U867A	✓	73
145TGR16038	I508	✓	84	160LFC6513	R339A	✓	105	182TDB6076	GT0005	✓	48	182TFN16047	E2210-P	✓	54
145TGR16039	I515	✓	84	160LFC6538	R337A	✓	105	182TDB6082	GT0405	✓	146	182TFN16101	L409B	✓	53
145TGR16040	I514	✓	84	160LFC6588	R335A	✓	105	182TDB6085	GT2405	✓	154	182TFN16584	E380A	✓	75
145TGR16076	I504	✓	84	160MFC6511	R333A	✓	105	182TDB6092	GT0505	✓	146	182TFR16017	M875B	✓	168
145TGR16080	I505	✓	84	160MFC6512	R336A	✓	105	182TDB6095	GT2505	✓	154	182TFR16018	E390	✓	76
145TTC4026	E837	✓	53	160MFC6536	R334A	✓	105	182TDR4113	U168	✓	155	182TFR16019	E392	✓	76
145TTN4005	E844	✓	54	160MFC6586	R332A	✓	105	182TDR4124	U166	✓	155	182TFW4345	C383A	✓	61
145TTN4035	E839	✓	53	161L110AAG1	AG195A	✓	245	182TDR4125	U169	✓	155	182TFW6001	E2009	✓	62
145TTN6001	E353	✓	54	161L110AAG4	A518	✓	245	182TDR8353	H953	✓	225	182TFW6026	E2010	✓	62
145TTN6501	E653	✓	76	161L113AAG1	AG109	✓	245	182TDW4028	C123B	✓	46	182TFW6076	E2005	✓	62
145TTN6505	E852	✓	76	161L113AAG2	AG110	✓	245	182TDW6001	U1248	✓	41	182TFW16001	E2109	✓	54
145TTN6521	E466	✓	76	161L113AAG3	AG111	✓	245	182TDW6030	E1930	✓	41	182TFW16002	E2159	✓	54
145TTN16037	E302A	✓	54	161L113AAG4	AG112	✓	245	182TDW6076	U1266	✓	40	182TFW16010	C203C	✓	59
145TTN16038	E301A	✓	53	161L113AAG5	AG113	✓	245	182TDW7101	H182A	✓	40	182TFW16020	E2134	✓	54
145TTN16039	U606A	✓	54	161L113AAG6	AG114	✓	245	182TDW7203	Y485A	✓	218	182TFW16021	C381B	✓	61
145TTN16045	U601A	✓	53	161L113AAG9	AG115	✓	245	182TDW7211	Y409A	✓	218	182TFW16026	E2110	✓	54
145TTN16628	E467A	✓	76	161L113ADG1	AG125	✓	245	182TDW7412	Y1484	✓	218	182TFW16027	C383B	✓	61
145TTN16629	E654A	✓	76	161L113ADG3	AG127	✓	245	182TDW7411	Y467A	✓	218	182TFW16030	C382B	✓	61
145TTN16630	E652A	✓	75	161L113ADG4	AG128	✓	245	182TDW7413	Y1453	✓	218	182TFW16038	E2160	✓	54
145TTN16631	E464A	✓	75	161L113ADG5	AG129	✓	245	182TDW16008	U908A	✓	41	182TFW16040	E2135	✓	54
145TTN16632	E668A	✓	76	161L113ADG14	AG130	✓	245	182TDW16009	U914	✓	40	182TFW16042	C223C	✓	59
145TTN16637	E667A	✓	75	161L185AAG1	AG212	✓	239	182TDW16010	U402C	✓	47	182TFW16045	G590A	✓	61
145TTN18531	S503	✓	220	161L186AAG1	AG195	✓	240	182TDW16018	M315C	✓	147	182TFW16047	G591A	✓	61
145TTN18532	S553	✓	220	161L187BAG1	A534	✓	239	182TDW16019	C104C	✓	46	182TFW16049	K640A	✓	59
145TTN18577	S501	✓	220	161L187BCG1	A535	✓	239	182TDW16021	E153B	✓	147	182TFW16076	E2105	✓	53
145TVR5030	N629	✓	124	161L188BAG1	A536	✓	240	182TDW16029	E915B	✓	41	182TFW16080	E2130	✓	53
145TVR5326	N607	✓	124	161L188BCG1	A537	✓	240	182TDW16048	U425B	✓	41	182TFW16082	E2155	✓	53
145TWD6001	N458A	✓	129	161L197ABG1	A958	✓	250	182TDW16049	U426B	✓	41	182TFW16085	K700A	✓	61
145TWD6026	N404A	✓	132	161L197ABG11	A959	✓	250	182TDW16059	U410A	✓	47	182TGN4068	C323A	✓	86
145TWD6027	N405A	✓	132	161L198AAG9	A956	✓	250	182TDW16062	E147B	✓	147	182TGN6501	U060A	✓	86
145TWD6028	N416A	✓	129	161L198AAG10	A957	✓	250	182TDW16063	E1930-P	✓	41	182TGN6526	U004A	✓	86
145TWD6029	N418A	✓	129	161L210AAP1	AG697	✓	250	182TDW16064	E904B	✓	41	182TGN6530	U023A	✓	86
145TWD6030	N459	✓	129	161L528AAG1	AG234	✓	248	182TDW16065	C123C	✓	46	182TGN6536	C368A	✓	83
145TWD6031	N436A	✓	128	180LFC6538	R343A	✓	105	182TDW16067	E148B	✓	147	182TGN6541	U989-P	✓	86
145TWD6077	N499	✓	129	180LFC6588	R338A	✓	105	182TDW16082	U925A	✓	41	182TGN6569	C364A	✓	83
145TWD6528	N438B	✓	128	180MFC6511	R342A	✓	105	182TDW16090	E799B	✓	40	182TGN6576	U040A	✓	86
145TWD14002	N154	✓	133	180MFC6536	R340A	✓	105	182TDW16311	E150B	✓	147	182TGN16003	C303B	✓	85
145TWD14003	N156	✓	133	182BFR5301	I206	✓	31	182TDW16315	E154B	✓	147	182TTL7034	C405	✓	109
145TWD14031	N153	✓	133	182BFR5326	I212	✓	31	182TDW16316	E933A	✓	41	182TTN16571	U1867	✓	74
145TWD14034	N469	✓	131	182CDR7013	Z309	✓	117	182TDW17008	M316B	✓	147	182TTS6001	E216	✓	54
145TWD16002	N444	✓	132	182CDR7354	Z424	✓	145	182TTFB6003	GT1209	✓	70	182TTS6030	E303	✓	54
145TWD16003	N443A	✓	132	182CDR8005	Z425	✓	145	182TTFB6004	GT1309	✓	69	182TTS6501	E601	✓	76
145TWD16004	N718	✓	135	182CDR8007	C173	✓	28	182TTFB6006	GT3109	✓	151	182TTS6505	E853	✓	76
145TWD16005	N768	✓	135	182CDW7001	I103A	✓	25	182TTFB6007	GT1409	✓	70	182TTS6526	E616	✓	76
145TWD16006	N156A	✓	133	182CDW7026	I112A	✓	25	182TTFB6008	GT3209	✓	151	182TTS6530	E669	✓	76
145TWD16007	N484A	✓	131	182CDW7074	Z405A	✓	144	182TTFB6012	GT3409	✓	159	182TTS6538	E470	✓	76
145TWD16008	N485A	✓	131	182CDW7318	Z406A	✓	144	182TTFB6013	GT3509	✓	159	182TTS6576	E632	✓	75
145TWD16009	N154A	✓	133	182CDW17084	I141A	✓	24	182TTFB6028	GT1210	✓	70	182TTS6578	E465	✓	75
145TWD16031	N771	✓	135	182TCPW7072	Z119A	✓	110	182TTFB6029	GT1310	✓	6				

Index

Model Number/Catalog Number

INDEX

MODEL NO.	CAT. NO.	STOCK	PAGE NO.	MODEL NO.	CAT. NO.	STOCK	PAGE NO.	MODEL NO.	CAT. NO.	STOCK	PAGE NO.	MODEL NO.	CAT. NO.	STOCK	PAGE NO.
182TTWD16026	N448B	✓	131	184TTD6076	U1267	✓	40	184TTF5290	Y380	✓	217	213THFS9030	W533	✓	80
182TTWD16027	N157A	✓	133	184TTD67101	H183A	✓	40	184TTF514101	L410A	✓	53	213THFS9076	W521	✓	80
182TTWD16076	N183B	✓	132	184TTD67209	Y1487	✓	218	184TTFW6001	E2012	✓	62	213THFW7726	Y994	✓	92
182TTWW4028	N656B	✓	123	184TTD67215	Y412A	✓	218	184TTFW6026	E2013	✓	62	213THFW7736	Y995	✓	92
182TTWW6026	N614B	✓	124	184TTD67230	Y468A	✓	218	184TTFW6076	E2008	✓	62	213THL7726	Y545	✓	93
182TTWW6027	N314B	✓	122	184TTD67286	Y454A	✓	218	184TTFW16001	E2112	✓	54	213THL7736	Y560	✓	93
182TTWW14031	N207	✓	125	184TTD67287	Y486A	✓	218	184TTFW16002	E2162	✓	54	213THL7776	Y542	✓	93
182TTWW16002	N634	✓	124	184TTD67611	Y302A	✓	118	184TTFW16006	C385B	✓	61	213THS9038	Y565	✓	95
182TTWW16026	N656C	✓	123	184TTD67612	Y1303	✓	118	184TTFW16012	C204C	✓	59	213THS9071	Y990	✓	97
182TTWW16027	N207A	✓	125	184TTD676001	U404B	✓	47	184TTFW16013	C238C	✓	59	213THS9001	W530	✓	80
182TTWW16087	N608A	✓	124	184TTD676027	E938A	✓	41	184TTFW16015	U360A	✓	151	213THS19005	W531	✓	80
184TBD5301	Z504	✓	216	184TTD676038	U428B	✓	41	184TTFW16020	E2137	✓	54	213TPFRB10230	SY068	✓	99
184TBD5326	Z502	✓	216	184TTD676040	E916B	✓	41	184TTFW16026	E2113	✓	54	213TPFA10096	SY008	✓	99
184TBD67324	Z313	✓	117	184TTD676041	U917	✓	41	184TTFW16027	C386B	✓	61	213TPNSB10234	SY008A	✓	99
184TBD67375	I119	✓	216,223	184TTD676043	U403A	✓	47	184TTFW16038	E2163	✓	54	213TDB6001	GT0018	✓	49
184TBD67628	I305	✓	223	184TTD676061	E1931-P	✓	41	184TTFW16029	C387B	✓	61	213TDB6007	GT0418	✓	148
184TBD67634	I308	✓	223	184TTD676068	C124C	✓	46	184TTFW16040	E2138	✓	54	213TDB6008	GT0518	✓	148
184TBD67001	I108A	✓	25,216	184TTD676071	E905B	✓	41	184TTFW16046	C224B	✓	59	213TDB6012	GT2418	✓	155
184TBD67009	Z307A	✓	117	184TTD676072	E157B	✓	147	184TTFW16051	C380B	✓	61	213TDB6013	GT2518	✓	155
184TBD67026	I114A	✓	25,216	184TTD676073	E158B	✓	147	184TTFW16076	E2108	✓	54	213TDB6026	GT0016	✓	49
184TBD67369	Z124A	✓	171	184TTD676074	E155A	✓	147	184TTFW16079	E2158	✓	54	213TDB6032	GT0416	✓	147
184TBD67630	I130A	✓	223	184TTD676076	U915	✓	40	184TTFW16081	E2133	✓	54	213TDB6033	GT0516	✓	147
184TBD67631	I128A	✓	223	184TTD676082	C152B	✓	46	184TTGN6501	U061A	✓	86	213TDB6037	GT2416	✓	155
184TBD67632	I131A	✓	223	184TTD676083	E918A	✓	40	184TTGN6526	U005A	✓	86	213TDB6038	GT2516	✓	155
184TBD67656	Z506A	✓	216	184TTD676304	C105C	✓	46	184TTGN6530	U024A	✓	86	213TDB6076	GT0011	✓	48
184TBD67007	Z408A	✓	144	184TTD676310	E163B	✓	147	184TTGN6537	C369A	✓	83	213TDB6082	GT0411	✓	147
184TBD67008	I104A	✓	25	184TTD676315	E937B	✓	41	184TTGN6544	U990-P	✓	86	213TDB6085	GT2411	✓	155
184TBD67011	Z427A	✓	145	184TTD676326	U427B	✓	41	184TTGN6575	C365A	✓	83	213TDB6092	GT0511	✓	147
184TBFW7034	I315A	✓	34,110,224	184TTD676338	M804B	✓	166	184TTGN6576	U041A	✓	86	213TDB6095	GT2511	✓	155
184TBFW7041	I314A	✓	34,110,224	184TTFB6003	GT1212	✓	70	184TTGN16004	C304B	✓	85	213TDB6001	GT0018A	✓	49
184TBFW7070	Z114A	✓	111	184TTFB6004	GT1312	✓	69	184TTGN16027	C324B	✓	85	213TDB6007	GT0418A	✓	148
184TBFW7315	Z433A	✓	144	184TTFB6006	GT3112	✓	151	184TTL7041	C406	✓	109	213TDB6008	GT0518A	✓	148
184TBFW7701	I223A	✓	31	184TTFB6007	GT1412	✓	70	184TTN16545	U1868	✓	74	213TDB6012	GT2418A	✓	155
184TBFW7726	I214A	✓	31	184TTFB6008	GT3212	✓	151	184TTTS6576	E633	✓	76	213TDB6013	GT2518A	✓	155
184TBFW7737	Z121A	✓	110	184TTFB6012	GT3412	✓	159	184TTTS6582	E468	✓	76	213TDB6026	GT0016A	✓	49
184TBFW17044	I213A	✓	31	184TTFB6013	GT3512	✓	159	184TTTS18577	S504	✓	220	213TDB6032	GT0416A	✓	147
184TBFW17045	Z120A	✓	110	184TTFB6028	GT1213	✓	70	184TTTS18578	S554	✓	220	213TDB6033	GT0516A	✓	147
184TCDR7076	I140A	✓	25	184TTFB6029	GT1313	✓	69	184TTY16033	C404A	✓	109	213TDB6037	GT2416A	✓	155
184TCDR7626	Z426	✓	145	184TTFB6031	GT3113	✓	151	184TTY16076	C402A	✓	109	213TDB6038	GT2516A	✓	155
184TCDR7627	I113A	✓	25	184TTFB6032	GT1413	✓	70	184TTWD6031	N407A	✓	132	213TDB6076	GT0011A	✓	48
184TCDR7004	Z407A	✓	144	184TTFB6033	GT3213	✓	151	184TTWD14002	N486	✓	131	213TDB6082	GT0411A	✓	147
184TCDR7615	Z305A	✓	117	184TTFB6037	GT3413	✓	159	184TTWD14033	N159	✓	133	213TDB6085	GT2411A	✓	155
184TCDR7617	Z306A	✓	117	184TTFB6038	GT3513	✓	159	184TTWD16002	N445A	✓	132	213TDB6092	GT0511A	✓	147
184TCFW9057	Z113A	✓	111	184TTFB6078	GT1208	✓	70	184TTWD16003	N158A	✓	133	213TDB6095	GT2511A	✓	155
184THFS9001	W523	✓	80	184TTFB6079	GT1308	✓	69	184TTWD16004	N486A	✓	131	213TDC6001	U764	✓	41
184THFS9026	W525	✓	80	184TTFB6082	GT3108	✓	151	184TTWD16032	N449B	✓	131	213TDC6003	U283	✓	41
184THFS9030	W526	✓	80	184TTFB6085	GT3408	✓	159	184TTWD16033	N159A	✓	133	213TDC6026	U763	✓	41
184THFS19006	W524	✓	80	184TTFB6092	GT3208	✓	151	184TTWW4002	N657B	✓	123	213TDC6029	U281	✓	41
184THFW7726	Y1372	✓	92	184TTFB6095	GT3508	✓	159	184TTWW6001	N615B	✓	124	213TDC6076	U268	✓	41
184THFW7736	Y373A	✓	92	184TTFB6003	GT1212A	✓	70	184TTWW6003	N317A	✓	122	213TDC6079	U279	✓	41
184THL7726	Y543	✓	93	184TTFB6004	GT1312A	✓	69	184TTWW6004	N315A	✓	122	213TDC6101	H184B	✓	218
184THL7736	Y559	✓	93	184TTFB6007	GT1412A	✓	70	184TTWW6026	N616B	✓	124	213TDDW7053	H955	✓	225
184THL7776	Y540	✓	93	184TTFB6028	GT1213A	✓	70	184TTWW6027	N316B	✓	122	213TDDW7201	Y489	✓	218
184THTS8028	Y564	✓	95	184TTFB6029	GT1313A	✓	69	184TTWW14005	N208	✓	125	213TDDW7202	Y488	✓	218
184THTS8056	Y989	✓	97	184TTFB6032	GT1413A	✓	70	184TTWW16002	N635	✓	124	213TDDW6030	E758A	✓	41
184THTS9076	W515	✓	79	184TTFB6078	GT1208A	✓	70	184TTWW16004	N657C	✓	123	213TDDW16010	U432A	✓	47
184THY7726	Y543A	✓	93	184TTFB6079	GT1308A	✓	69	184TTWW16005	N208A	✓	125	213TDDW16060	U430A	✓	47
184THY7736	Y559A	✓	93	184TTFC6001	GT1012	✓	64	184TTWW16006	N210A	✓	125	213TDDW16061	U926A	✓	41
184THY17038	Y287A	✓	92	184TTFC6005	GT1112	✓	64	184TTWW16026	N658C	✓	123	213TDDW16063	U405A	✓	47
184TPFRB10214	SY067	✓	99	184TTFC6026	GT1013	✓	64	184TTWW16027	N209A	✓	125	213TDDW16075	U430A-P	✓	41
184TPFA10095	SY007	✓	99	184TTFC6027	U618A	✓	54	200LFC6511	R345A	✓	105	213TDDW16024	C106B	✓	46
184TPNSB10236	SY007A	✓	99	184TTFC6030	GT1113	✓	64	200LFC6513	R348A	✓	105	213TDDW16060	U430B	✓	41
184TDB6001	GT0015	✓	49	184TTFC6076	GT1008	✓	63	200LFC6538	R346A	✓	105	213TDDW16063	U405B	✓	47
184TDB6007	GT0415	✓	147	184TTFC6080	GT1108	✓	63	200LFC6588	R341A	✓	105	215TDDW16073	U431B-P	✓	41
184TDB6008	GT0515	✓	147	184TTFCD6001	GT1012A	✓	64	200LFC6589	R344A	✓	105	213TDDW16075	U430B-P	✓	41
184TDB6012	GT2415	✓	155	184TTFCD6005	GT1112A	✓	64	213TBFW7001	I224	✓	31	213TDDW16086	U907A	✓	41
184TDB6013	GT2515	✓	155	184TTFCD6026	GT1013A	✓	64	213TBFW7010	Z434	✓	144	213TDDW16089	M802B	✓	166
184TDB6026	GT0013	✓	48	184TTFCD6030	GT1113A	✓	64	213TBFW7026	I216	✓	31	213TDDW16307	E173A	✓	148
184TDB6032	GT0413	✓	147	184TTFCD6076	GT1008A	✓	63	213TBFW7027	Z117	✓	111	213TDDW16310	E706A	✓	41
184TDB6033	GT0513	✓	147	184TTFCD6080	GT1108A	✓	63	213TCDW7001	I105	✓	25,216	213TDDW16314	E939A	✓	41
184TDB6037	GT2413	✓	155	184TTFN6555	U868A	✓	73	213TCDW7002	Z410	✓	144	213TDDW16330	E720B	✓	41
184TDB6038	GT2513	✓	155	184TTFN6576	E388A	✓	76	213TCDW7003	Z429	✓	145	213TDDW16333	E168A	✓	147
184TDB6076	GT0008	✓	48	184TTFN16056	E202-P	✓	54	213TCDW7026	I117	✓	25	213TDDW16334	E906B	✓	41
184TDB6082	GT0408	✓	146	184TTFN16105	L410C	✓	53	213TCDW7027	Z409	✓	144	213TDDW16342	M807B	✓	166
184TDB6085	GT2408	✓	154	184TFR16054	M879B	✓	168	213TCDW7028	Z428	✓	145	213TDDW16345	U185A	✓	155
184TDB6092	GT0508	✓	146	184TFS6501	E602	✓	76	213TCDW7076	I143	✓	25	213TDDW16349	U429A	✓	41
184TDB6095	GT2508	✓	154	184TFS6505	E655	✓	76	213THFN9030	W533A	✓	80	213TDDW16347	E167A	✓	147
184TDR9040	H954														

MODEL NO.	CAT. NO.	STOCK	PAGE NO.	MODEL NO.	CAT. NO.	STOCK	PAGE NO.	MODEL NO.	CAT. NO.	STOCK	PAGE NO.	MODEL NO.	CAT. NO.	STOCK	PAGE NO.
213TTFB6031	GT3116	✓	151	213TTFW16081	E2136	✓	54	215TBFW7027	I217	✓	31	215TDDW7301	Y304	✓	118
213TTFB6033	GT3216	✓	151	213TTFW16082	E2161	✓	54	215TBFW7028	Z115	✓	111	215TDDW7376	Y201	✓	221
213TTFB6037	GT3416	✓	159	213TTFW16085	M877B	✓	168	215TBFW7029	Z122	✓	110	215TDDW7377	Y202	✓	221
213TTFB6038	GT3516	✓	159	213TTFWD6001	E2015A	✓	62	215TBFW7044	Z116	✓	111	215TDDW14020	U201A	✓	156
213TTFB6082	GT3111	✓	151	213TTFWD6076	E2011A	✓	62	215TCDW7002	Z412	✓	144	215TDDW16061	U433A	✓	47
213TTFB6085	GT3411	✓	159	213TTFWD16001	E2115A	✓	55	215TCDW7003	Z308	✓	117	215TDDW16073	U431A-P	✓	41
213TTFB6092	GT3211	✓	151	213TTFWD16008	C389B	✓	61	215TCDW7004	Z431	✓	145	215TDDW16340	C126B	✓	46
213TTFB6095	GT3511	✓	159	213TTFWD16012	C205B	✓	59	215TCDW7012	Z314	✓	117	215TDDW17206	Y490	✓	218
213TTFBA6003	GT1215	✓	71	213TTFWD16014	U327A	✓	151	215TCDW17002	I106	✓	25	215TDDW4003	E788A	✓	42
213TTFBA6004	GT1315	✓	69	213TTFWD16016	M881B	✓	168	215TBDW17003	Z315A	✓	117	215TDDW4022	E113A	✓	148
213TTFBA6007	GT1415	✓	71	213TTFWD16026	E2116A	✓	55	215THFND19033	W540A	✓	80	215TDDW4023	E183A	✓	148
213TTFBA6028	GT1216	✓	71	213TTFWD16035	C390B	✓	61	215THFS8029	Y596	✓	95	215TDDW14018	M813B	✓	166
213TTFBA6029	GT1316	✓	69	213TTFWD16036	C391B	✓	61	215THFS9001	W537	✓	80	215TDDW14020	U201B	✓	156
213TTFBA6032	GT1416	✓	71	213TTFWD16039	E2016B	✓	62	215THFS9026	W539	✓	80	215TDDW16087	E935A	✓	41
213TTFBA6078	GT1211	✓	70	213TTFWD16047	C225C	✓	59	215THFS9076	W527	✓	80	215TDDW16091	M805B	✓	166
213TTFBA6079	GT1311	✓	69	213TTFWD16076	E2111A	✓	54	215THFS9101	W522	✓	80	215TDDW16345	E759A	✓	42
213TTFBD6003	GT1215A	✓	71	213TTFWD16078	C384B	✓	61	215THFS19006	W538	✓	80	215TDDW16346	E907A	✓	41
213TTFBD6004	GT1315A	✓	69	213TTGN6501	U062A	✓	87	215THFS19033	W540	✓	80	215TDDW16349	E178A	✓	148
213TTFBD6006	GT1315A	✓	151	213TTGN6526	U006A	✓	87	215THFS19077	W528	✓	80	215TDDW16350	M810B	✓	166
213TTFBD6007	GT1415A	✓	71	213TTGN6528	C366A	✓	83	215THFW7726	Y996	✓	92	215TDDW16364	E175A	✓	148
213TTFBD6008	GT3215A	✓	151	213TTGN6536	C370A	✓	83	215THFW7736	Y997	✓	92	215TDFB6006	GT3118	✓	151
213TTFBD6012	GT3415A	✓	159	213TTGN6540	U991A	✓	87	215HTL7726	Y547	✓	93	215TDFB6008	GT3218	✓	151
213TTFBD6013	GT3515A	✓	159	213TTGN6576	U042A	✓	86	215HTL7736	Y561	✓	93	215TDFB6012	GT3418	✓	159
213TTFBD6028	GT1216A	✓	71	213TTGN16027	C325B	✓	85	215HTL7776	Y544	✓	93	215TDFB6013	GT3518	✓	159
213TTFBD6029	GT1316A	✓	69	213TTGN16537	U025A	✓	87	215HTS8038	Y566	✓	95	215TDFB6031	GT3119	✓	152
213TTFBD6031	GT3116A	✓	151	213TTGN16548	U991A-P	✓	87	215HTS8071	Y991	✓	97	215TDFB6033	GT3219	✓	152
213TTFBD6032	GT1416A	✓	71	213TTGND6501	U062B	✓	87	215TPFRB10219	SY069	✓	99	215TDFB6037	GT3419	✓	159
213TTFBD6033	GT3216A	✓	151	213TTGND6526	U006B	✓	87	215TPFA10097	SY009	✓	99	215TDFB6038	GT3519	✓	159
213TTFBD6037	GT3416A	✓	159	213TTGND6528	C366B	✓	83	215TPNSB10235	SY009A	✓	99	215TDFB6082	GT3114	✓	151
213TTFBD6038	GT3516A	✓	159	213TTGND6536	C370B	✓	83	215TTDB6001	GT0021	✓	49	215TDFB6085	GT3414	✓	159
213TTFBD6078	GT1211A	✓	70	213TTGND6540	U991B	✓	87	215TTDB6007	GT0421	✓	148	215TDFB6092	GT3214	✓	151
213TTFBD6079	GT1311A	✓	69	213TTGND16001	C305B	✓	85	215TTDB6008	GT0521	✓	148	215TDFB6095	GT3514	✓	159
213TTFBD6082	GT3111A	✓	151	213TTGND16027	C325C	✓	85	215TTDB6012	GT2421	✓	156	215TDFBA6003	GT1218	✓	71
213TTFBD6085	GT3411A	✓	159	213TTGND16537	U025B	✓	87	215TTDB6013	GT2521	✓	156	215TDFBA6004	GT1318	✓	69
213TTFBD6092	GT3211A	✓	151	213TTGND16548	U991B-P	✓	87	215TTDB6026	GT0019	✓	49	215TDFBA6007	GT1418	✓	71
213TTFBD6095	GT3511A	✓	159	213TTGS14015	C305	✓	85	215TTDB6032	GT0419	✓	148	215TDFBA6028	GT1219	✓	71
213TTFC6001	GT1015	✓	64	213TTTL16038	C407A	✓	109	215TTDB6033	GT0519	✓	148	215TDFBA6029	GT1319	✓	69
213TTFC6005	GT1115	✓	64	213TTTN16539	U1869	✓	74	215TTDB6037	GT2419	✓	156	215TDFBA6032	GT1419	✓	71
213TTFC6006	U671A	✓	55	213TTND6501	E603A	✓	76	215TTDB6038	GT2519	✓	156	215TDFBA6078	GT1214	✓	70
213TTFC6026	GT1016	✓	64	213TTND6502	E475A	✓	76	215TTDB6076	GT0014	✓	48	215TDFBA6079	GT1314	✓	69
213TTFC6027	U629A	✓	55	213TTND6505	E656A	✓	76	215TTDB6082	GT0414	✓	147	215TDFBD6003	GT1218A	✓	71
213TTFC6030	GT1116	✓	64	213TTND16539	U1869A	✓	74	215TTDB6085	GT2414	✓	155	215TDFBD6004	GT1318A	✓	69
213TTFC6076	GT1011	✓	64	213TTND16541	U1870A	✓	74	215TTDB6092	GT0514	✓	147	215TDFBD6006	GT3118A	✓	151
213TTFCD6080	GT1111	✓	64	213TTTS6001	E218	✓	55	215TTDB6095	GT2514	✓	155	215TDFBD6007	GT1418A	✓	71
213TTFCD6001	GT1015A	✓	64	213TTTS6501	E603	✓	76	215TTDBD6001	GT0021A	✓	49	215TDFBD6008	GT3218A	✓	151
213TTFCD6005	GT1115A	✓	64	213TTTS6502	E475	✓	76	215TTDBD6007	GT0421A	✓	148	215TDFBD6012	GT3418A	✓	159
213TTFCD6026	GT1016A	✓	64	213TTTS6505	E656	✓	76	215TTDBD6008	GT0521A	✓	148	215TDFBD6013	GT3518A	✓	159
213TTFCD6030	GT1116A	✓	64	213TTTS17077	S507	✓	220	215TTDBD6012	GT2421A	✓	156	215TDFBD6028	GT1219A	✓	71
213TTFCD6076	GT1011A	✓	64	213TTTS17078	S557	✓	220	215TTDBD6013	GT2521A	✓	156	215TDFBD6029	GT1319A	✓	69
213TTFCD6080	GT1111A	✓	64	213TTWD6031	N408A	✓	132	215TTDBD6026	GT0019A	✓	49	215TDFBD6031	GT3119A	✓	152
213TTFN6550	U869A	✓	73	213TTWD14002	N160	✓	133	215TTDBD6032	GT0419A	✓	148	215TDFBD6032	GT1419A	✓	71
213TTFN16101	L411B	✓	54	213TTWD14032	N161	✓	133	215TTDBD6033	GT0519A	✓	148	215TDFBD6033	GT3219A	✓	152
213TTFN16326	E203-P	✓	55	213TTWD16002	N446A	✓	132	215TTDBD6037	GT2419A	✓	156	215TDFBD6037	GT3419A	✓	159
213TTFND6526	E618A	✓	76	213TTWDD6031	N408B	✓	132	215TTDBD6038	GT2519A	✓	156	215TDFBD6038	GT3519A	✓	159
213TTFND6530	E671A	✓	76	213TTWD16003	N160A	✓	133	215TTDBD6076	GT0014A	✓	48	215TDFBD6078	GT1214A	✓	70
213TTFND6531	E476A	✓	76	213TTWDD16026	N161A	✓	133	215TTDBD6082	GT0414A	✓	147	215TDFBD6079	GT1314A	✓	69
213TTFND6576	E634A	✓	76	213TTWR4001	N659A	✓	123	215TTDBD6085	GT2414A	✓	155	215TDFBD6082	GT3114A	✓	151
213TTFND6594	E471A	✓	76	213TTWR6002	N617A	✓	124	215TTDBD6092	GT0514A	✓	147	215TDFBD6085	GT3414A	✓	159
213TTFND16326	E203A-P	✓	55	213TTWR6026	N618A	✓	124	215TTDBD6095	GT2514A	✓	155	215TDFBD6092	GT3214A	✓	151
213TTFNS6501	E396	✓	76	213TTWR6027	N318A	✓	122	215TTDC6001	U766	✓	42	215TDFBD6095	GT3514A	✓	159
213TTFNS6526	E618	✓	76	213TTWR7026	N660	✓	123	215TTDC6003	U286	✓	42	215TDFC6001	GT1018	✓	64
213TTFNS6530	E671	✓	76	213TTWRD6002	N617B	✓	124	215TTDC6026	U765	✓	41	215TDFC6002	U636A	✓	55
213TTFNS6531	E476	✓	76	213TTWRD6026	N618B	✓	124	215TTDC6029	U284	✓	42	215TDFC6005	GT1118	✓	64
213TTFNS6576	E634	✓	76	213TTWRD6027	N318B	✓	122	215TTDC6076	U269	✓	41	215TDFC6026	GT1019	✓	65
213TTFNS6594	E471	✓	76	213TTWW14031	N211	✓	125	215TTDC6079	U280	✓	41	215TDFC6027	U639A	✓	55
213TTFNS7238	Y381	✓	217	213TTWW16002	N325	✓	122	215TDR16101	H185B	✓	41	215TDFC6030	GT1119	✓	65
213TTFW6001	E2015	✓	62	213TTWWD16003	N659B	✓	123	215TDW4007	E184	✓	148	215TDFC6031	U641A	✓	55
213TTFW6076	E2011	✓	62	213TTWWD16026	N211A	✓	125	215TDW4008	E180	✓	148	215TDFC6076	GT1014	✓	64
213TTFW16001	E2115	✓	55	213TTWWD16028	N660A	✓	123	215TDW4009	E181	✓	148	215TDFC6077	U621A	✓	54
213TTFW16008	C389A	✓	61	215TBDR7361	Z125	✓	171	215TDW4010	E182	✓	148	215TDFC6080	GT1114	✓	64
213TTFW16011	U622A	✓	55	215TBDW7026	I115	✓	25,216	215TDW4011	U200	✓	156	215TDFC6001	GT1018A	✓	64
213TTFW16020	E2140	✓	55	215TBDW7027	Z413	✓	144	215TDW4022	E113	✓	148	215TDFC6005	GT1118A	✓	64
213TTFW16026	E2116	✓	55	215TBDW7028	I116	✓	25,216	215TDW4023	E183	✓	148	215TDFC6026	GT1019A	✓	65
213TTFW16035	C390A	✓	61	215TBDW7029	Z411	✓	144	215TDW4025	U204	✓	156	215TDFC6030	GT1119A	✓	65
213TTFW16036	C391A	✓	61	215TBDW7030	Z432	✓	145	215TDW4078	E935	✓	41	215TDFC6076	GT1014A	✓	64
213TTFW16039	E2016A	✓	62	215TBDW7045	Z430	✓	145	215TDW4315	U435	✓	47	215TDFCD6080	GT1114A	✓	64
213TTFW16040	E2141	✓	55	215TBDW7079	I144	✓	25	215TDDW7053	H956	✓	225	215TFN6546	U870A	✓	73
213TTF															

Index

Model Number/Catalog Number

INDEX

MODEL NO.	CAT. NO.	STOCK	PAGE NO.	MODEL NO.	CAT. NO.	STOCK	PAGE NO.	MODEL NO.	CAT. NO.	STOCK	PAGE NO.	MODEL NO.	CAT. NO.	STOCK	PAGE NO.
215TTFND6526	E619A	✓	76	215TTWRD6027	N319B	✓	122	254TTDX4014	U212	✓	156	254TFL16032	U723A	✓	61
215TTFND6527	E479A	✓	76	215TTWW14007	N214	✓	125	254TTDX4015	E193	✓	148	254TFL16036	E2122-P	✓	55
215TTFND6530	E672A	✓	76	215TTWW14008	N664	✓	123	254TTDX4016	U217	✓	156	254TFL16038	U646B	✓	55
215TTFND6546	U870B	✓	73	215TTWW14009	N212	✓	125	254TTDX4017	U213	✓	156	254TFL16039	C227B	✓	59
215TTFND6576	E635A	✓	76	215TTWW16002	N663	✓	123	254TTDX4018	U900	✓	42	254TFL16040	E2147	✓	55
215TTFND6881	E474A	✓	76	215TTWW16003	N637	✓	124	254TTDX4019	E192	✓	148	254TFL16041	U721A	✓	61
215TTFND16057	E204A-P	✓	55	215TTWW16003	N637A	✓	124	254TTDX4020	E194	✓	148	254TFL16043	U349A	✓	152
215TFS4005	U637	✓	55	215TTWW16005	N212A	✓	125	254TTDX4024	E195	✓	148	254TFL16045	U348A	✓	152
215TFS6030	E306	✓	55	215TTWW16006	N664A	✓	123	254TTDX4315	U437	✓	47	254TFL16076	E2117	✓	55
215TFS6501	E604	✓	76	215TTWW16007	N214A	✓	125	254TTDX7201	Y470	✓	218	254TFL16077	E2142	✓	55
215TFS6505	E657	✓	76	215TTWW16026	N213A	✓	125	254TTDX7208	Y418	✓	218	254TFL16078	C255B	✓	59
215TFS6526	E619	✓	76	215TTWW16027	N661A	✓	123	254TTDX7278	Y456	✓	218	254TFNA6001	E220	✓	55
215TFS6527	E479	✓	76	225MTFC6501	R500	✓	105	254TTDX7377	Y203	✓	221	254TFNA6026	E205	✓	55
215TFS6530	E672	✓	76	225MTFC6526	R501	✓	105	254TTDX8338	H957	✓	225	254TFNA6030	E307	✓	55
215TFS6576	E635	✓	76	225MTFC6586	R347A	✓	105	254TTDX16010	E708A	✓	42	254TFNA6076	E235	✓	55
215TFS6580	E683	✓	76	225STFC6526	R349A	✓	105	254TTDX16042	E722A	✓	42	254TFNA6501	E605	✓	77
215TFS6807	E478	✓	76	250MTFC6501	R503	✓	105	254TTDX16043	E722A-P	✓	42	254TFNA6503	E658	✓	77
215TFS6881	E474	✓	76	250MTFC6526	R504	✓	105	254TTDX16054	M814B	✓	166	254TFNA6515	E481	✓	77
215TFS7290	Y382	✓	217	250MTFC6586	R350A	✓	105	254TTDX16055	U209A	✓	156	254TFNA6526	E620	✓	77
215TFW6001	E2018	✓	62	254THEN8058	Y982	✓	96	254TTDX16082	E733A	✓	41	254TFNA6528	E673	✓	77
215TFW6026	E2019	✓	62	254THEN8059	Y983	✓	96	254TTDX16086	M808B	✓	166	254TFNA6529	E482	✓	77
215TFW6076	E2014	✓	62	254THFA8038	Y597	✓	95	254TFC6006	U638A	✓	55	254TFNA6576	E636	✓	76
215TFW16001	E2118	✓	55	254THFA9001	W544	✓	80	254TFC6027	U647B	✓	55	254TFNA6578	E684	✓	76
215TFW16005	C392A	✓	61	254THFA9026	W546	✓	80	254TFC6077	U633A	✓	55	254TFNA6590	E477	✓	76
215TFW16020	E2143	✓	55	254THFA9030	W547	✓	80	254TFC6081	E005	✓	55	254TFNA7210	Y383	✓	217
215TFW16026	E2119	✓	55	254THFA9076	W534	✓	80	254TFC6A001	GT1021	✓	65	254TFNA14103	L412A	✓	54
215TFW16040	E2144	✓	55	254THFA9101	W529	✓	80	254TFC6A003	GT1221	✓	71	254TFNA14336	Y1609	✓	164
215TFW16041	C393A	✓	61	254THFA19065	W546-P	✓	80	254TFC6A005	GT1121	✓	65	254TFNA16074	E205-P	✓	55
215TFW16042	C394A	✓	61	254THL5726	Y549	✓	93	254TFC6A006	GT3121	✓	152	254TFNA16088	M883B	✓	168
215TFW16047	E2019A	✓	62	254THL5736	Y562	✓	93	254TFC6A007	GT1421	✓	71	254TFNA16568	U871A	✓	73
215TFW16076	E2114	✓	54	254THL5776	Y546	✓	93	254TFC6A008	GT3221	✓	152	254TFNA16838	E620-P	✓	77
215TFW16079	C388A	✓	61	254THNA8058	Y509	✓	95	254TFC6A012	GT3421	✓	160	254TFNA16088	Y1608	✓	164
215TFW16080	E2139	✓	54	254THNA8071	Y992	✓	97	254TFC6A013	GT3521	✓	160	254TGN6507	E502	✓	87
215TFW16081	E2164	✓	54	254TPSA10088	SY010	✓	99	254TFC6A026	GT1022	✓	65	254TGN6531	E503	✓	87
215TFWD6001	E2018A	✓	62	254TTDBD6001	GT0061	✓	49	254TFC6A028	GT1222	✓	71	254TGN6576	E500	✓	87
215TFWD6076	E2014A	✓	62	254TTDBD6007	GT0461	✓	148	254TFC6A030	GT1122	✓	65	254TGN14042	C327A	✓	85
215TFWD16001	E2118A	✓	55	254TTDBD6008	GT0561	✓	148	254TFC6A031	GT3122	✓	152	254TGN16034	C327B	✓	85
215TFWD16005	C392A	✓	61	254TTDBD6012	GT2461	✓	156	254TFC6A032	GT1422	✓	71	254TGN16524	C307B	✓	85
215TFWD16010	C206B	✓	59	254TTDBD6013	GT2561	✓	155	254TFC6A033	GT3222	✓	152	254TGN16541	U027A	✓	87
215TFWD16011	U336A	✓	151	254TTDBD6026	GT0059	✓	49	254TFC6A037	GT3422	✓	160	254TGN16549	E503-P	✓	87
215TFWD16012	C237B	✓	59	254TTDBD6032	GT0459	✓	148	254TFC6A038	GT3522	✓	160	254TTNA16545	U1871	✓	74
215TFWD16013	U357A	✓	152	254TTDBD6033	GT0559	✓	148	254TFC6A076	GT1017	✓	64	254TTNA17077	S513	✓	220
215TFWD16017	M884B	✓	168	254TTDBD6037	GT2459	✓	156	254TFC6A078	GT1217	✓	71	254TTNA18530	S518	✓	220
215TFWD16018	U743A	✓	61	254TTDBD6038	GT2559	✓	155	254TFC6A080	GT1117	✓	64	256TBDX7028	Z127	✓	171
215TFWD16026	E2119A	✓	55	254TTDBD6076	GT0057	✓	49	254TFC6A082	GT3117	✓	151	256TBDX17035	Z319	✓	117
215TFWD16041	C393B	✓	61	254TTDBD6082	GT0457	✓	147	254TFC6A085	GT3417	✓	159	256TBR17026	Z129	✓	111
215TFWD16047	E2019B	✓	62	254TTDBD6085	GT2457	✓	155	254TFC6A092	GT3217	✓	159	256THEN17031	Y984	✓	96
215TFWD16051	C226B	✓	59	254TTDBD6092	GT0557	✓	147	254TFC6A095	GT3517	✓	159	256THFA8038	Y598	✓	95
215TFWD16052	E822A	✓	55	254TTDBD6095	GT2557	✓	155	254TFC6D001	GT1021A	✓	65	256THFA9001	W551	✓	80
215TFWD16076	E2114A	✓	54	254TTDC6001	U768	✓	42	254TFC6D003	GT1221A	✓	71	256THFA9026	W553	✓	80
215TFWD16079	C388B	✓	61	254TTDC6003	U289	✓	42	254TFC6D005	GT1121A	✓	65	256THFA9076	W541	✓	80
215TFWD16084	M880B	✓	168	254TTDC6026	U767	✓	42	254TFC6D006	GT3121A	✓	152	256THFA9101	W536	✓	80
215TGN6501	U063A	✓	87	254TTDC6029	U287	✓	42	254TFC6D007	GT1421A	✓	71	256THFA19033	W554	✓	80
215TGN6526	U007A	✓	87	254TTDC6079	U282	✓	41	254TFC6D008	GT3221A	✓	152	256THFA19056	W553-P	✓	80
215TGN6528	C367A	✓	83	254TTDCA6001	GT0024	✓	49	254TFC6D012	GT3421A	✓	160	256THFA19081	W542	✓	80
215TGN6539	U992A	✓	87	254TTDCA6007	GT0424	✓	148	254TFC6D013	GT3521A	✓	160	256THL5776	Y548	✓	93
215TGN6576	U043A	✓	86	254TTDCA6008	GT0524	✓	148	254TFC6D026	GT1022A	✓	65	256THNA7026	Y552	✓	94
215TGN16532	U026A	✓	87	254TTDCA6012	GT2424	✓	156	254TFC6D028	GT1222A	✓	71	256THNA7036	Y563	✓	94
215TGN16534	C371A	✓	83	254TTDCA6013	GT2524	✓	156	254TFC6D030	GT1122A	✓	65	256THNA8038	Y510	✓	95
215TGN16539	U992A-P	✓	87	254TTDCA6026	GT0022	✓	49	254TFC6D031	GT3122A	✓	152	256THNA8071	Y993	✓	97
215TGN6501	U063B	✓	87	254TTDCA6032	GT0422	✓	148	254TFC6D032	GT1422A	✓	71	256TPSA10087	SY011	✓	99
215TGN6526	U007B	✓	87	254TTDCA6033	GT0522	✓	148	254TFC6D033	GT3222A	✓	152	256TTDBD4008	U1100	✓	161
215TGN6528	C367B	✓	83	254TTDCA6037	GT2422	✓	156	254TFC6D037	GT3422A	✓	160	256TTDBD6013	U500A	✓	161
215TGN6539	U992B	✓	87	254TTDCA6038	GT2522	✓	156	254TFC6D038	GT3522A	✓	160	256TTDBD4024	U501A	✓	161
215TGN6576	U043B	✓	86	254TTDCA6076	GT0017	✓	49	254TFC6D076	GT1017A	✓	64	256TTDBD6001	GT0064	✓	49
215TGN16006	C306B	✓	85	254TTDCA6082	GT0417	✓	147	254TFC6D078	GT1217A	✓	71	256TTDBD6007	GT0464	✓	149
215TGN16029	C326B	✓	85	254TTDCA6085	GT2417	✓	155	254TFC6D080	GT1117A	✓	64	256TTDBD6008	GT0564	✓	149
215TGN16532	U026B	✓	87	254TTDCA6092	GT0517	✓	147	254TFC6D082	GT3117A	✓	151	256TTDBD6012	GT2464	✓	157
215TGN16539	U992B-P	✓	87	254TTDCA6095	GT2517	✓	155	254TFC6D085	GT3417A	✓	159	256TTDBD6013	GT2564	✓	157
215TTL7050	C408	✓	109	254TDR16056	U436A	✓	47	254TFC6D092	GT3217A	✓	151	256TTDBD6026	GT0062	✓	49
215TTN16541	U1870	✓	74	254TDR16101	H186B	✓	41	254TFC6D095	GT3517A	✓	159	256TTDBD6032	GT0462	✓	149
215TTS17077	S510	✓	220	254TDR16026	U207A	✓	156	254TFL14008	U345A	✓	160	256TTDBD6033	GT0562	✓	149
215TTS17078	S560	✓	220	254TDR16027	E188A	✓	148	254TFL16001	E2121	✓	55	256TTDBD6037	GT2462	✓	156
215TTWD6031	N409A	✓	132	254TDR16028	U210A	✓	156	254TFL16006	U643A	✓	55	256TTDBD6038	GT2562	✓	155
215TTWD16002	N447A	✓	132	254TDR16029	E908A	✓	42	254TFL16007	C207B	✓	59	256TTDBD6076	GT0058	✓	49
215TTWD16003	N162A	✓	133	254TDR16031	E114B	✓	148	254TFL16008	U344A	✓	152	256TTDBD6082	GT0458	✓	148
215TTWD16026	N163A	✓	133	254TDX4006	E191	✓	148	254TFL16009	U343A	✓	160	256TTDBD6085	GT2458	✓	156
215TTWD6031	N409B	✓	132	254TDX4007	E190	✓	148	254TFL16010	U345B	✓	160	256TTDBD6092	GT0558	✓	148

MODEL NO.	CAT. NO.	STOCK	PAGE NO.	MODEL NO.	CAT. NO.	STOCK	PAGE NO.	MODEL NO.	CAT. NO.	STOCK	PAGE NO.	MODEL NO.	CAT. NO.	STOCK	PAGE NO.
256TTDC6029	U290	✓	42	256TTFCD6080	GT1120A	✓	65	284TSTDP4004	U901	✓	42	284TTFCA6038	GT3528	✓	160
256TTDC6079	U285	✓	42	256TTFCD6082	GT3120A	✓	152	284TSTDR16003	E1008	✓	42	284TTFCA6076	GT1023	✓	65
256TTDCA6001	GT0027	✓	49	256TTFCD6085	GT3420A	✓	159	284TSTFC6036	E999A	✓	56	284TTFCA6080	GT1123	✓	65
256TTDCA6007	GT0427	✓	149	256TTFCD6092	GT3220A	✓	152	284TSTFCA6001	GT1027	✓	65	284TTFCA6082	GT3123	✓	152
256TTDCA6008	GT0527	✓	149	256TTFCD6095	GT3520A	✓	159	284TSTFCA6003	GT1227	✓	71	284TTFCA6085	GT3423	✓	160
256TTDCA6012	GT2427	✓	157	256TTFLL4006	U351	✓	152	284TSTFCA6005	GT1127	✓	65	284TTFCA6092	GT3223	✓	152
256TTDCA6013	GT2527	✓	157	256TTFLL16002	E2123	✓	56	284TSTFCD6001	GT1027A	✓	65	284TTFCA6095	GT3523	✓	160
256TTDCA6026	GT0025	✓	49	256TTFLL16004	U351A	✓	152	284TSTFCD6003	GT1227A	✓	71	284TTFCD6006	GT3127A	✓	152
256TTDCA6032	GT0425	✓	149	256TTFLL16020	E2148	✓	56	284TSTFCD6005	GT1127A	✓	65	284TTFCD6008	GT3227A	✓	152
256TTDCA6033	GT0525	✓	149	256TTFLL16033	E2124	✓	56	284TSTFCD6026	GT1057	✓	66	284TTFCD6012	GT3427A	✓	160
256TTDCA6037	GT2425	✓	156	256TTFLL16038	E2124-P	✓	56	284TSTFNA6001	E222	✓	56	284TTFCD6013	GT3527A	✓	160
256TTDCA6038	GT2525	✓	156	256TTFLL16039	U651A	✓	56	284TSTFNA6501	E607	✓	77	284TTFCD6026	GT1028A	✓	66
256TTDCA6076	GT0020	✓	49	256TTFLL16040	E2149	✓	56	284TSTFNA6502	E660	✓	77	284TTFCD6028	GT1228A	✓	66
256TTDCA6082	GT0420	✓	148	256TTFLL16041	U353B	✓	152	284TSTFPA14007	Y1612	✓	164	284TTFCD6030	GT1128A	✓	71
256TTDCA6085	GT2420	✓	156	256TTFLL16042	U354A	✓	152	284TSTGN6503	E546	✓	87	284TTFCD6032	GT3128A	✓	152
256TTDCA6092	GT0520	✓	148	256TTFLL16076	E2120	✓	55	284TSTGN16531	U076A	✓	87	284TTFCD6033	GT3228A	✓	160
256TTDCA6095	GT2520	✓	156	256TTFLL16077	E2145	✓	55	284TTDBD4027	U598	✓	161	284TTFCD6037	GT3428A	✓	160
256TTDN16009	U439A	✓	47	256TTFNA6001	E221	✓	56	284TTDBD4035	U1101	✓	161	284TTFCD6038	GT3528A	✓	160
256TTDN16018	M721A	✓	166	256TTFNA6026	E206	✓	56	284TTDBD4047	U599	✓	161	284TTFCD6076	GT1023A	✓	65
256TTDN16049	U438A	✓	47	256TTFNA6030	E308	✓	56	284TTDBD6007	GT0469	✓	149	284TTFCD6080	GT1123A	✓	65
256TTDN16067	M718A	✓	166	256TTFNA6076	E236	✓	55	284TTDBD6008	GT0569	✓	149	284TTFCD6082	GT3123A	✓	152
256TTDN16082	M711	✓	166	256TTFNA6501	E606	✓	77	284TTDBD6012	GT2469	✓	157	284TTFCD6085	GT3423A	✓	160
256TTDR16004	U225A	✓	157	256TTFNA6503	E659	✓	77	284TTDBD6013	GT2569	✓	157	284TTFCD6092	GT3223A	✓	152
256TTDR16008	U103A	✓	149	256TTFNA6523	E484	✓	77	284TTDBD6026	GT0065	✓	49	284TTFCD6095	GT3523A	✓	160
256TTDR16010	E786A	✓	42	256TTFNA6526	E621	✓	77	284TTDBD6032	GT0465	✓	149	284TTFNA6026	E207	✓	56
256TTDR16026	E197A	✓	149	256TTFNA6528	E674	✓	77	284TTDBD6033	GT0565	✓	149	284TTFNA6030	E309	✓	56
256TTDR16027	E909A	✓	42	256TTFNA6529	E485	✓	77	284TTDBD6037	GT2465	✓	157	284TTFNA6076	E237	✓	55
256TTDR16029	M818B	✓	166	256TTFNA6576	E637	✓	76	284TTDBD6038	GT2565	✓	157	284TTFNA6526	E622	✓	77
256TTDR16031	U219A	✓	156	256TTFNA6578	E685	✓	76	284TTDBD6076	GT0060	✓	49	284TTFNA6527	E675	✓	77
256TTDN16101	H187B	✓	41	256TTFNA6596	E480	✓	76	284TTDBD6082	GT0460	✓	148	284TTFNA6576	E638	✓	77
256TTDX4020	U501	✓	161	256TTFNA7250	Y384	✓	217	284TTDBD6085	GT2460	✓	156	284TTFNA6580	E694	✓	77
256TTDX4024	U500	✓	161	256TTFNA14022	Y1610	✓	164	284TTDBD6092	GT0560	✓	148	284TTFNA6837	E488	✓	77
256TTDX7207	Y492	✓	218	256TTFNA14071	Y1611	✓	164	284TTDBD6095	GT2560	✓	155	284TTFNA6876	E483	✓	77
256TTDX7253	Y471	✓	218	256TTFNA14101	L413A	✓	55	284TDC6026	U771	✓	42	284TTFNA7240	Y385	✓	217
256TTDX7263	Y457	✓	218	256TTFNA16031	M893B	✓	168	284TDC6029	E762A	✓	42	284TTFNA14102	L414A	✓	55
256TTDX7264	Y458	✓	218	256TTFNA16070	E206-P	✓	56	284TDC6076	U256	✓	42	284TTFNA16015	M896B	✓	168
256TTDX7391	Y204	✓	221	256TTFNA16096	C256B	✓	59	284TDC6079	U288	✓	42	284TTFNA16070	E207-P	✓	56
256TTDX16006	E709A	✓	42	256TTFNA16099	M886B	✓	168	284TTDCA6007	GT0430	✓	149	284TTFNA16129	U655A	✓	56
256TTDX16032	E723B	✓	42	256TTFNA16101	L413B	✓	55	284TTDCA6008	GT0530	✓	149	284TTFNA16131	M897B	✓	168
256TTDX16033	E723B-P	✓	42	256TTFNA16106	M892B	✓	168	284TTDCA6012	GT2430	✓	157	284TTFNA16832	U873A	✓	73
256TTDX16078	E734A	✓	42	256TTFNA16574	H872A	✓	73	284TTDCA6013	GT2530	✓	157	284TTFNA16851	E622-P	✓	77
256TTFCA6002	U649A	✓	56	256TTFNA16855	E621-P	✓	77	284TTDCA6026	GT0028	✓	49	284TTFPA4028	U655	✓	56
256TTFCA6007	U652B	✓	56	256TTFNA16856	E506	✓	87	284TTDCA6032	GT0428	✓	149	284TTFPA14055	Y1613	✓	164
256TTFCA6011	U642A	✓	55	256TTFNA16857	E501	✓	87	284TTDCA6033	GT0528	✓	149	284TTFPA16033	M890B	✓	168
256TTFCA6001	GT1024	✓	65	256TTFNA16858	E621-P	✓	77	284TTDCA6037	GT2428	✓	157	284TTGNA6533	E547	✓	87
256TTFCA6003	GT1224	✓	71	256TTFNA16859	E506	✓	87	284TTDCA6038	GT2528	✓	157	284TTGNA6576	E504	✓	87
256TTFCA6005	GT1124	✓	65	256TTFNA16860	E505	✓	87	284TTDCA6076	GT0023	✓	49	284TTGNA16539	U029A	✓	87
256TTFCA6006	GT3124	✓	152	256TTFNA16861	U028A	✓	87	284TTDCA6082	GT0423	✓	148	284TTGNA16550	E547-P	✓	87
256TTFCA6008	GT3224	✓	152	256TTFNA16862	E506-P	✓	87	284TTDCA6085	GT2423	✓	156	284TTTNA16540	U1873	✓	74
256TTFCA6012	GT3424	✓	160	256TTFNA16863	U1872	✓	74	284TTDCA6092	GT0523	✓	148	284TTTNA16577	S519	✓	220
256TTFCA6013	GT3524	✓	160	256TTFNA18577	S566	✓	220	284TTDCA6095	GT2523	✓	156	284TTTNA17101	S567	✓	220
256TTFCA6026	GT1025	✓	65	256TTFNA18578	S516	✓	220	284TTDN16007	M725	✓	166	284TTTNA18577	S569	✓	220
256TTFCA6028	GT1225	✓	71	256TTFNA18579	S564	✓	220	284TTDN16008	U230A	✓	157	284TTTNA18601	S517	✓	220
256TTFCA6030	GT1125	✓	65	280TTFCA6588	R505	✓	105	284TTDN16009	U108A	✓	149	286TTFNA8028	Y570	✓	95
256TTFCA6031	GT3125	✓	152	280TTFCA6589	R506	✓	105	284TTDN16052	E910A	✓	42	286TTFNA9026	W567	✓	80
256TTFCA6033	GT3225	✓	152	280TTFCA6590	R507	✓	105	284TTDN16059	U105A	✓	149	286TTFNA9076	W555	✓	80
256TTFCA6037	GT3425	✓	160	280TTFCA6591	R502	✓	105	284TTDN16060	U227A	✓	157	286TTFNA19033	W568	✓	80
256TTFCA6038	GT3525	✓	160	284THFN8032	Y985	✓	96	284TTDN16063	M722	✓	166	286TTFNA19066	W567-P	✓	80
256TTFCA6076	GT1020	✓	65	284THFN9026	W560	✓	80	284TTDN16087	M715	✓	166	286TTFNA19077	W556	✓	80
256TTFCA6078	GT1220	✓	71	284THFN9076	W548	✓	80	284TTDN16101	H188B	✓	42	286TTFNA19101	W550	✓	80
256TTFCA6080	GT1120	✓	65	284THFN19048	W560-P	✓	80	284TTDP4027	U502	✓	161	286TTFPA8038	Y512	✓	95
256TTFCA6082	GT3120	✓	152	284THFN19084	W549	✓	80	284TTDP4047	U503	✓	161	286TTFPA8086	Y582	✓	95
256TTFCA6085	GT3420	✓	159	284THFN19033	W561	✓	80	284TTDP7202	Y493	✓	218	286THTNA7026	Y393	✓	94
256TTFCA6092	GT3220	✓	152	284THFN19102	W543	✓	80	284TTDP7205	Y472	✓	218	286THTNA7036	Y394	✓	94
256TTFCA6095	GT3520	✓	159	284THFPA8028	Y569	✓	95	284TTDP7221	Y459	✓	218	286TTFSA10090	SY013	✓	99
256TTFCD6001	GT1024A	✓	65	284THFPA8038	Y511	✓	95	284TTDP7692	Y215	✓	221	286TSHFNA9001	W565	✓	80
256TTFCD6003	GT1224A	✓	71	284THFPA8086	Y395	✓	95	284TDR16047	E1006	✓	42	286TSTDBD4008	U1106	✓	161
256TTFCD6005	GT1124A	✓	65	284THITNA7026	Y553	✓	94	284TDR16048	E1006-P	✓	42	286TSTDBD4022	U592	✓	161
256TTFCD6006	GT3124A	✓	152	284THITNA7036	Y567	✓	94	284TDR16077	E1002	✓	42	286TSTDBD4023	U593	✓	161
256TTFCD6008	GT3224A	✓	152	284TPFSA10112	SY012	✓	99	284TFC6031	E800A	✓	56	286TSTDBD6001	GT0072	✓	50
256TTFCD6012	GT3424A	✓	160	284TSHFNA9001	W558	✓	80	284TFC6077	E978A	✓	55	286TSTD6003	U293	✓	42
256TTFCD6013	GT3524A	✓	160	284TSHFNA9005	W559	✓	80	284TTFCA6006	GT3127	✓	152	286TSTDC6001	GT0033	✓	50
256TTFCD6026	GT1025A	✓	65	284TSTDC6003	U292	✓	42	284TTFCA6008	GT3227	✓	152	286TSTDN16004	U443A	✓	47
256TTFCD6028	GT1225A	✓	71	284TSTDBD4002	U597	✓	161	284TTFCA6012	GT3427	✓	160	286TSTDN16005	U441A	✓	47
256TTFCD6030	GT1125A	✓	65	284TSTDBD4007	U596	✓	161	284TTFCA6013	GT3527	✓	160	286TSTDN16011	U902A	✓	42
256TTFCD6031	GT3125A	✓	152	284TSTDBD4008	U1103	✓	161	284TTFCA6026	GT1028	✓	65	286TSTDN16033	U442A	✓	47
256TTFCD6033	GT3225A	✓	152	284TSTDBD6001	GT0069	✓	49	284TTFCA6028	GT1228	✓	71	286TSTDN16034	U440		

Index

Model Number/Catalog Number

INDEX

MODEL NO.	CAT. NO.	STOCK	PAGE NO.	MODEL NO.	CAT. NO.	STOCK	PAGE NO.	MODEL NO.	CAT. NO.	STOCK	PAGE NO.	MODEL NO.	CAT. NO.	STOCK	PAGE NO.
286TSTFC6036	E818A	✓	56	286TTFCD6008	GT3230A	✓	153	324TTDBD6026	GT0073	✓	50	324TTF6576	E640	✓	77
286TSTFCA6001	GT1030	✓	66	286TTFCD6012	GT3430A	✓	160	324TTDBD6032	GT0473	✓	149	324TTF6577	E696	✓	77
286TSTFCA6003	GT1230	✓	72	286TTFCD6013	GT3530A	✓	160	324TTDBD6033	GT0573	✓	149	324TTF67290	Y387	✓	217
286TSTFCA6005	GT1130	✓	66	286TTFCD6026	GT1031A	✓	66	324TTDBD6037	GT2473	✓	157	324TTF61011	M904B	✓	168
286TSTFCD6001	GT1030A	✓	66	286TTFCD6028	GT1231A	✓	72	324TTDBD6038	GT2573	✓	157	324TTF61606	E209-P	✓	56
286TSTFCD6003	GT1230A	✓	72	286TTFCD6030	GT1131A	✓	66	324TTDBD6076	GT0068	✓	49	324TTF61607	M898B	✓	168
286TSTFCD6005	GT1130A	✓	66	286TTFCD6032	GT1311A	✓	153	324TTDBD6082	GT0468	✓	149	324TTF616105	L416B	✓	56
286TSTFCD6026	GT1058	✓	66	286TTFCD6033	GT2331A	✓	153	324TTDBD6085	GT2468	✓	157	324TTF616837	U875A	✓	73
286TSTFNA6001	E223	✓	56	286TTFCD6037	GT3431A	✓	160	324TTDBD6092	GT0568	✓	149	324TTF616860	E624-P	✓	77
286TSTFNA6501	E608	✓	77	286TTFCD6038	GT3531A	✓	160	324TTDBD6095	GT2568	✓	157	324TGS6529	E567	✓	87
286TSTFNA6804	E490	✓	77	286TTFCD6076	GT1026A	✓	65	324TTDC6029	E764A	✓	42	324TTF616535	U031A	✓	87
286TSTFPA14006	Y1614	✓	164	286TTFCD6080	GT1126A	✓	65	324TTDC6076	U798	✓	42	324TGS16541	E567-P	✓	87
286TSTGN6501	E563	✓	87	286TTFCD6082	GT3126A	✓	152	324TTCA6007	GT0436	✓	149	324TGS16577	U048A	✓	87
286TSTGN16531	U077A	✓	87	286TTFCD6085	GT3426A	✓	160	324TTCA6008	GT0536	✓	149	324TTF616535	U1875	✓	74
286TTDBD4035	U1104	✓	161	286TTFCD6092	GT3226A	✓	152	324TTCA6012	GT2436	✓	157	324TTF618577	S525	✓	220
286TTDBD4041	U594	✓	161	286TTFCD6095	GT3526A	✓	160	324TTCA6013	GT2536	✓	157	324TTF618601	S523	✓	220
286TTDBD14042	U595	✓	161	286TTFNA6026	E208	✓	56	324TTCA6026	GT0034	✓	50	326THFPA8038	Y514	✓	95
286TTDBD6007	GT0472	✓	149	286TTFNA6030	E310	✓	56	324TTCA6032	GT0434	✓	149	326THFPA8086	Y584	✓	95
286TTDBD6008	GT0572	✓	149	286TTFNA6076	E238	✓	56	324TTCA6033	GT0534	✓	149	326THFS8028	Y572	✓	95
286TTDBD6012	GT2472	✓	157	286TTFNA6526	E623	✓	77	324TTCA6037	GT2434	✓	157	326THFS9026	W580	✓	81
286TTDBD6013	GT2572	✓	157	286TTFNA6527	E676	✓	77	324TTCA6038	GT2534	✓	157	326THFS9076	W569	✓	80
286TTDBD6026	GT0067	✓	49	286TTFNA6570	E491	✓	77	324TTCA6076	GT0029	✓	49	326THFS19033	W581	✓	81
286TTDBD6032	GT0467	✓	149	286TTFNA6576	E639	✓	77	324TTCA6082	GT0429	✓	149	326THFS19071	W580-P	✓	81
286TTDBD6033	GT0567	✓	149	286TTFNA6580	E695	✓	77	324TTCA6085	GT2429	✓	157	326THFS19078	W643	✓	80
286TTDBD6037	GT2467	✓	157	286TTFNA6876	E486	✓	77	324TTCA6092	GT0529	✓	149	326THFS9001	W577	✓	81
286TTDBD6038	GT2567	✓	157	286TTFNA7260	Y386	✓	217	324TTCA6095	GT2529	✓	157	326THFS9005	W578	✓	81
286TTDBD6076	GT0063	✓	49	286TTFNA14050	Y1615	✓	164	324TTCCD4035	U1107	✓	161	326THFS9036	W579	✓	81
286TTDBD6082	GT0463	✓	149	286TTFNA16021	M900B	✓	168	324TTCCD4038	U510A	✓	161	326TSTDBD6001	GT0080	✓	50
286TTDBD6085	GT2463	✓	156	286TTFNA16096	M894B	✓	168	324TTCCD14049	U511A	✓	161	326TSTDCA6001	GT0039	✓	50
286TTDBD6092	GT0563	✓	149	286TTFNA16106	L415B	✓	55	324TTDP4030	E787	✓	42	326TSTDCD4008	U1112	✓	162
286TTDBD6095	GT2563	✓	155	286TTFNA16328	E208-P	✓	56	324TTDP4038	U510	✓	161	326TSTDCD4022	U517A	✓	162
286TTDC6026	U773	✓	42	286TTFNA16341	M901B	✓	168	324TTDP7687	Y217	✓	221	326TSTDCD4024	U516A	✓	162
286TTDC6029	E763A	✓	42	286TTFNA16572	U874A	✓	73	324TTDP14049	U511	✓	161	326TSTDP4022	U517	✓	162
286TTDCA6007	GT0433	✓	149	286TTFNA16847	E623-P	✓	77	324TTDR16007	M833B	✓	167	326TSTDP4024	U516	✓	162
286TTDCA6008	GT0533	✓	149	286TTFNA6537	E564	✓	77	324TTDR16050	U775-P	✓	42	326TSTDP16005	U447A	✓	47
286TTDCA6012	GT2433	✓	157	286TTGN16533	U030A	✓	87	324TTDR16054	E787A	✓	42	326TSTDP16032	E789A	✓	42
286TTDCA6013	GT2533	✓	157	286TTGN16546	E564-P	✓	87	324TTDR16056	M830B	✓	167	326TSTDP16014	U910A	✓	43
286TTDCA6026	GT0031	✓	49	286TTGN16577	E507	✓	87	324TTDR16091	M823B	✓	166	326TSTDR14034	U521	✓	162
286TTDCA6032	GT0431	✓	149	286TTNA16541	U1874	✓	74	324TTDN16101	M720	✓	166	326TSTDR16034	E791A	✓	43
286TTDCA6033	GT0531	✓	149	286TTNA18577	S522	✓	220	324TTDN16077	M723	✓	166	326TSTDR16035	U446A	✓	47
286TTDCA6037	GT2431	✓	157	286TTNA18602	S520	✓	220	324TTFC6007	GT3133	✓	153	326TSTFC6036	E801A	✓	56
286TTDCA6038	GT2531	✓	157	315STFC6588	R508	✓	105	324TTFCA6008	GT3233	✓	153	326TSTFCA6001	GT1036	✓	66
286TTDCA6076	GT0026	✓	49	324THFA8028	Y571	✓	95	324TTFCA6012	GT3433	✓	160	326TSTFCA6003	GT1236	✓	72
286TTDCA6082	GT0426	✓	149	324THFA8038	Y513	✓	95	324TTFCA6013	GT3533	✓	160	326TSTFCA6005	GT1136	✓	66
286TTDCA6085	GT2426	✓	156	324THFA8086	Y583	✓	95	324TTFCA6026	GT1034	✓	66	326TSTFCD6001	GT1036A	✓	66
286TTDCA6092	GT0526	✓	149	324THFS9026	W573	✓	81	324TTFCA6028	GT1234	✓	72	326TSTFCD6003	GT1236A	✓	72
286TTDCA6095	GT2526	✓	156	324THFS9076	W562	✓	80	324TTFCA6030	GT1134	✓	66	326TSTFCD6005	GT1136A	✓	66
286TTDN16011	M729	✓	167	324THFS9080	W563	✓	80	324TTFCA6031	GT1314	✓	153	326TSTFCD6026	GT1060	✓	66
286TTDN16073	E911A	✓	42	324THFS19033	W574	✓	81	324TTFCA6033	GT3234	✓	153	326TSTFPA14013	Y1619	✓	164
286TTDN16102	H189B	✓	42	324THFS19058	W573-P	✓	81	324TTFCA6037	GT3434	✓	160	326TSTFS6001	E225	✓	56
286TTDN16093	M719	✓	166	324THFS9001	W571	✓	81	324TTFCA6038	GT3534	✓	160	326TSTFS6005	E320	✓	56
286TTDN16330	M726	✓	166	324TSTDC6003	U294	✓	43	324TTFCA6076	GT1029	✓	66	326TSTFS6501	E610	✓	77
286TTDN16331	U111A	✓	149	324TSTDC6001	GT0036	✓	50	324TTFCA6080	GT1129	✓	66	326TSTFS6502	E663	✓	77
286TTDN16332	U233A	✓	157	324TSTDBD6001	GT0076	✓	50	324TTFCA6082	GT3129	✓	152	326TSTFS6536	E453	✓	77
286TDP4041	U506	✓	161	324TSTDCD4007	U513A	✓	161	324TTFCA6085	GT3429	✓	160	326TSTFS6501	E569	✓	88
286TDP7217	Y460	✓	218	324TSTDCD4008	U1109	✓	161	324TTFCA6092	GT3229	✓	152	326TSTGS16532	U079A	✓	88
286TDP7251	Y473	✓	218	324TSTDCD4010	U512A	✓	161	324TTFCA6095	GT3529	✓	160	326TTDBD6026	GT0077	✓	50
286TDP7689	Y216	✓	221	324TSTDP4007	U513	✓	161	324TTFC6007	GT3133A	✓	153	326TTDBD6032	GT0477	✓	149
286TDP14042	U507	✓	161	324TSTDP4010	U512	✓	161	324TTFC6008	GT3233A	✓	153	326TTDBD6033	GT0577	✓	149
286TDR16037	E1009	✓	42	324TSTDP16002	U445A	✓	47	324TTFC6012	GT3433A	✓	160	326TTDBD6037	GT2477	✓	157
286TDR16038	E1009-P	✓	42	324TSTDP16009	U909A	✓	43	324TTFC6013	GT3533A	✓	160	326TTDBD6038	GT2577	✓	157
286TFC6027	E983B	✓	56	324TSTDP16032	U444A	✓	47	324TTFC6026	GT1034A	✓	66	326TTDBD6076	GT0071	✓	49
286TFC6031	E817A	✓	56	324TSTFC6036	E816A	✓	56	324TTFC6028	GT1234A	✓	72	326TTDBD6082	GT0471	✓	149
286TFC6006	GT3130	✓	153	324TSTFCA6001	GT1033	✓	66	324TTFC6030	GT1134A	✓	66	326TTDBD6085	GT2471	✓	157
286TFC6008	GT3230	✓	153	324TSTFCA6003	GT1233	✓	72	324TTFC6031	GT3134A	✓	153	326TTDBD6092	GT0571	✓	149
286TFC6012	GT3430	✓	160	324TSTFCA6005	GT1133	✓	66	324TTFC6033	GT3234A	✓	153	326TTDBD6095	GT2571	✓	157
286TFC6013	GT3530	✓	160	324TSTFCD6001	GT1033A	✓	66	324TTFC6037	GT3434A	✓	160	326TDC6026	U777	✓	43
286TFC6026	GT1031	✓	66	324TSTFCD6003	GT1233A	✓	72	324TTFC6038	GT3534A	✓	160	326TDC6029	E765A	✓	43
286TFC6028	GT1231	✓	72	324TSTFCD6005	GT1133A	✓	66	324TTFC6076	GT1029A	✓	66	326TDC6026	GT0037	✓	50
286TFC6030	GT1131	✓	66	324TSTFCD6026	GT1059	✓	66	324TTFC6080	GT1129A	✓	66	326TDC6032	GT0437	✓	149
286TFC6032	GT3131	✓	153	324TSTFPA14010	Y1616	✓	164	324TTFC6082	GT3129A	✓	152	326TDC6033	GT0537	✓	149
286TFC6033	GT3231	✓	153	324TSTFS6001	E224	✓	56	324TTFC6085	GT3429A	✓	160	326TDC6037	GT2437	✓	157
286TFC6037	GT3431	✓	160	324TSTFS6005	E319	✓	56	324TTFC6092	GT3229A	✓	152	326TDC6038	GT2537	✓	157
286TFC6038	GT3531	✓	160	324TSTFS6501	E609	✓	77	324TTFC6095	GT3529A	✓	160	326TDC6076	GT0032	✓	49
286TFC6076	GT1026	✓	65	324TSTFS6505	E662	✓	77	324TTFPA14071	Y1618	✓	164	326TDC6082	GT0432	✓	149
286TFC6080	GT1126	✓	65	324TSTGS6501	E566	✓	87	324TTF6026	E209	✓	56	326TDC6085	GT2432	✓	157
286TFC6082	GT3126	✓	152	324TSTGS16531	U078A	✓	87	324TTF6030	E311	✓	56	326TDC609			

MODEL NO.	CAT. NO.	STOCK	PAGE NO.	MODEL NO.	CAT. NO.	STOCK	PAGE NO.	MODEL NO.	CAT. NO.	STOCK	PAGE NO.	MODEL NO.	CAT. NO.	STOCK	PAGE NO.
326TDP4344	U515	✓	161	364TSTDCB6060	GT0095	✓	51	365TSTDBD6001	GT0086	✓	51	365TGS16540	E576A	✓	88
326TDP4345	U514	✓	161	364TSTDCD4008	U1115	✓	162	365TSTDBD6060	GT0085	✓	51	365TGS16542	U034A	✓	88
326TDP7697	Y218	✓	221	364TSTDCD4024	U523A	✓	162	365TSTDCB6001	GT0045	✓	51	365TGS16577	E571	✓	88
326TDDN16035	M734	✓	167	364TSTDCD4025	U522A	✓	162	365TSTDCB6060	GT0094	✓	51	365TTS16536	U1878	✓	74
326TDR16005	M837B	✓	167	364TSTDCD4035	U1113	✓	162	365TSTDCD4008	U1118	✓	162	404THFS8092	Y587	✓	95
326TDR16063	E791A-P	✓	43	364TSTDCD4332	U518A	✓	162	365TSTDCD4025	U526A	✓	162	404THFS9086	W589	✓	81
326TDR16073	E790A	✓	43	364TSTDCD4337	U519A	✓	162	365TSTDCD4035	U1116	✓	162	404THFS9101	W583	✓	81
326TDR16101	H191B	✓	42	364TSTDS4024	U523	✓	162	365TSTDCD4303	U527A	✓	162	404TSTDC6001	GT0048	✓	51
326TDR16102	M824B	✓	166	364TSTDS4025	U522	✓	162	365TSTDCD4332	U524A	✓	162	404TSTDC6060	GT0093	✓	51
326TDDN16101	M724	✓	166	364TSTDS4332	U518	✓	162	365TSTDCD4347	U525A	✓	162	404TSTDC4008	U1121	✓	162
326TFC6633	Y818A	✓	215	364TSTDS4337	U519	✓	162	365TSTDS4025	U526	✓	162	404TSTDC4017	U530A	✓	162
326TFC6607	GT3136	✓	153	364TSTFCA6001	GT1039	✓	67	365TSTDS4303	U527	✓	162	404TSTDC4035	U1119	✓	162
326TFC6608	GT3236	✓	153	364TSTFCA6003	GT1129	✓	72	365TSTDS4332	U524	✓	162	404TSTDC4332	U528A	✓	162
326TFC6612	GT3436	✓	160	364TSTFCA6005	GT1139	✓	67	365TSTDS4347	U525	✓	162	404TSTDC4333	U529A	✓	162
326TFC6613	GT3536	✓	160	364TSTFCD6001	GT1039A	✓	67	365TSTDS6074	U450A	✓	47	404TSTDC14008	U531A	✓	162
326TFC6626	GT1037	✓	66	364TSTFCD6003	GT1129A	✓	72	365TSTDS16005	U451A	✓	47	404TSTDC6001	GT0048A	✓	51
326TFC6628	GT1237	✓	72	364TSTFCD6005	GT1139A	✓	67	365TSTDS16008	U449A	✓	47	404TSTDC6060	GT0093A	✓	51
326TFC6630	GT1137	✓	66	364TSTFCD6036	GT1061	✓	67	365TSTDS16041	E782C	✓	43	404TSTDS4017	U530	✓	162
326TFC6631	GT13137	✓	153	364TSTFS6001	E226	✓	57	365TSTDS16042	E768C	✓	43	404TSTDS4332	U528	✓	162
326TFC6633	GT3237	✓	153	364TSTFS6005	E321	✓	57	365TSTDS16044	U448A	✓	47	404TSTDS4333	U529	✓	162
326TFC6637	GT3437	✓	160	364TSTFS6501	E611	✓	77	365TSTFC6003	E991A	✓	57	404TSTDS6001	U250	✓	43
326TFC6638	GT3537	✓	160	364TSTFS6505	E664	✓	77	365TSTFC6026	E804A	✓	57	404TSTDS6327	U452A	✓	47
326TFC6676	GT1032	✓	66	364TSTFS6526	E454	✓	77	365TSTFCA6001	GT1042	✓	67	404TSTDS14008	U531	✓	162
326TFC6680	GT1132	✓	66	364TSTFS14009	Y1622	✓	164	365TSTFCA6002	GT1142	✓	67	404TSTDS16006	U453A	✓	47
326TFC6682	GT13132	✓	153	364TSTGS6506	E572	✓	88	365TSTFCA6003	GT1242	✓	72	404TSTDS16036	E780A	✓	43
326TFC6685	GT3432	✓	160	364TSTGS16531	U080A	✓	88	365TSTFCD6001	GT1042A	✓	67	404TDC6060	GT0046	✓	51
326TFC6692	GT3232	✓	153	364TTDBD6060	GT0081	✓	50	365TSTFCD6002	GT1142A	✓	67	404TDC6086	GT0041	✓	50
326TFC6695	GT3532	✓	160	364TTDBD6086	GT0075	✓	50	365TSTFCD6003	GT1242A	✓	72	404TDC6060	GT0046A	✓	51
326TFC6607	GT3136A	✓	153	364TTDCA6060	U1779	✓	43	365TTDCA6036	GT1062	✓	67	404TDC6086	GT0041A	✓	50
326TFC6608	GT3236A	✓	153	364TTDCA6086	U1927	✓	42	365TSTFS6001	E227	✓	57	404TDS6060	E922	✓	43
326TFC6612	GT3436A	✓	160	364TTDCB6060	GT0040	✓	50	365TSTFS6002	E322	✓	57	404TDS6086	U270	✓	43
326TFC6613	GT3536A	✓	160	364TTDCB6086	GT0035	✓	50	365TSTFS6501	E612	✓	78	404TDS7387	Y210	✓	221
326TFC6626	GT1037A	✓	66	364TTDS4328	U520	✓	162	365TSTFS6502	E665	✓	78	404TDS16010	M749	✓	167
326TFC6628	GT1237A	✓	72	364TTDS14329	U538	✓	162	365TSTFS6526	E455	✓	78	404TDS16055	U030A	✓	43
326TFC6630	GT1137A	✓	67	364TTDS16009	M741	✓	167	365TSTFS14009	Y1625	✓	164	404TDS16093	M739	✓	167
326TFC6631	GT13137A	✓	153	364TTDS16052	M738	✓	167	365TSTGS16503	E575	✓	88	404TDS16102	M736	✓	167
326TFC6633	GT3237A	✓	153	364TTDS16088	M731	✓	167	365TSTGS16532	U081A	✓	88	404TDS16332	M746	✓	167
326TFC6637	GT3437A	✓	160	364TTDS16105	M728	✓	166	365TTDBD6060	GT0084	✓	51	404TFC6080	GT1141	✓	67
326TFC6638	GT3537A	✓	160	364TFC6633	Y819A	✓	215	365TTDBD6086	GT0079	✓	50	404TFC6086	GT1041	✓	67
326TFC6676	GT1032A	✓	66	364TFC6636	GT1040	✓	67	365TTDCA6086	U1928	✓	43	404TFC6683	Y850A	✓	215
326TFC6680	GT1132A	✓	66	364TFC6638	GT1240	✓	72	365TTDCB6060	GT0043	✓	50	404TFC6680	GT1141A	✓	67
326TFC6682	GT13132A	✓	153	364TFC6640	GT1140	✓	67	365TTDCB6086	GT0038	✓	50	404TFC6686	GT1041A	✓	67
326TFC6685	GT3432A	✓	160	364TFC6680	GT1135	✓	66	365TTDS6060	E921	✓	43	404TFS6086	E243	✓	57
326TFC6692	GT3232A	✓	153	364TFC6686	GT1035	✓	66	365TDS7383	Y209	✓	221	404TFS6586	E644	✓	77
326TFC6695	GT3532A	✓	160	364TFC6636	GT1040A	✓	67	365TTDS16016	M745	✓	167	404TFS6592	E403	✓	77
326TFPA14049	M909A	✓	168	364TFC6638	GT1240A	✓	72	365TTDS16064	E767A	✓	43	404TFS8102	L426	✓	56
326TFS6026	E210	✓	56	364TFC6640	GT1140A	✓	67	365TTDS16067	E766A	✓	43	404TFS16098	M914B	✓	169
326TFS6030	E312	✓	56	364TFC6680	GT1135A	✓	66	365TTDS16072	M742	✓	167	404TFS16103	L426A	✓	56
326TFS6076	E240	✓	56	364TFC6686	GT1035A	✓	66	365TTDS16086	M735	✓	167	404TGS6588	E574	✓	88
326TFS6526	E625	✓	77	364TFS6036	E211	✓	57	365TTDS16101	M732	✓	167	405THFS8036	Y575	✓	96
326TFS6527	E678	✓	77	364TFS6040	E313	✓	57	365TTDS16326	E920A	✓	43	405THFS8046	Y517	✓	96
326TFS6576	E641	✓	77	364TFS6059	M913B	✓	169	365TFC6087	E993A	✓	56	405THFS8378	Y588	✓	95
326TFS6580	E400	✓	77	364TFS6536	E626	✓	77	365TFC6633	Y820A	✓	215	405THFS9036	W600	✓	81
326TFS9210	Y388	✓	217	364TFS6537	E679	✓	77	365TFC6683	Y840A	✓	215	405THFS9040	W601	✓	81
326TFS14046	Y1621	✓	164	364TFS8101	L420	✓	56	365TFC6636	GT1043	✓	67	405THFS9086	W596	✓	81
326TFS16037	M909B	✓	168	364TFS9234	Y389	✓	217	365TFC6638	GT1243	✓	72	405THFS19101	W590	✓	81
326TFS16073	E210-P	✓	56	364TFS14064	Y1624	✓	164	365TFC6640	GT1143	✓	67	405THFS19327	W600-P	✓	81
326TFS16102	L417B	✓	56	364TFS16008	M912B	✓	169	365TFC6680	GT1138	✓	67	405THFS9001	W598	✓	81
326TFS16106	M899B	✓	168	364TFS16083	E241A	✓	56	365TFC6686	GT1038	✓	67	405THFS9026	W599	✓	81
326TFS16377	M902B	✓	168	364TFS16087	M906B	✓	168	365TFC6636	GT1043A	✓	67	405TSTDC6007	GT0051	✓	51
326TFS16574	U876A	✓	73	364TFS16104	L420A	✓	56	365TFC6638	GT1243A	✓	72	405TSTDC4006	U534A	✓	162
326TFS16844	E625-P	✓	77	364TFS16558	U877A	✓	73	365TFC6640	GT1143A	✓	67	405TSTDC4008	U1124	✓	162
326TGS6532	E570	✓	88	364TFS16584	E642A	✓	77	365TFC6680	GT1138A	✓	67	405TSTDC4035	U1122	✓	162
326TGS6578	E565	✓	87	364TFS16585	E401A	✓	77	365TFC6686	GT1038A	✓	67	405TSTDC4332	U532A	✓	162
326TGS16539	U032A	✓	88	364TFS16833	E626-P	✓	77	365TFS6036	E212	✓	57	405TSTDC4333	U533A	✓	162
326TGS16546	E570-P	✓	88	364TGS16536	E573A	✓	88	365TFS6040	E315	✓	57	405TSTDC6007	GT0051A	✓	51
326TTS16533	U1876	✓	74	364TGS16537	U033A	✓	88	365TFS6536	E627	✓	78	405TSTDS4006	U534	✓	162
326TTS18577	S528	✓	220	364TGS16577	E568A	✓	87	365TFS6537	E680	✓	78	405TSTDS4332	U532	✓	162
364THFS8036	Y573	✓	95	364TGS16534	U1877	✓	74	365TFS8115	L425	✓	56	405TSTDS4333	U533	✓	162
364THFS8046	Y515	✓	95	365THFS8036	Y574	✓	95	365TFS9230	Y390	✓	217	405TSTDS6007	U251	✓	43
364THFS8331	Y585	✓	95	365THFS8046	Y516	✓	95	365TFS14071	Y1627	✓	164	405TSTDS16005	U455A	✓	47
364THFS9036	W587	✓	81	365THFS8380	Y586	✓	95	365TFS16013	M916B	✓	169	405TSTDS16038	E781A	✓	43
364THFS19033	W598	✓	81	365THFS9036	W594	✓	81	365TFS16083	E242A	✓	56	405TSTDS16039	U454A	✓	47
364THFS19061	W587-P	✓	81	365THFS9044	W595	✓	81	365TFS16088	M910B	✓	168	405TSTFC6001	GT1045	✓	67
364THFS19077	W639	✓	81	365THFS19065	W594-P	✓	81	365TFS16103	L425A	✓	56	405TSTFC6003	GT1245	✓	72
364THFS19087	W575A	✓	81	365THFS19077	W640	✓	81	365TFS16105	M907B	✓	168	405TSTFC6005	GT1145	✓	67
364SHFS9001	W584	✓	81	365THFS19086	W582A	✓	81	365TFS16132	M917B	✓	169	405TSTFC6001	GT1045A	✓	67
364SHFS9026	W586	✓	81	365THFS19101	W576	✓	81	365TFS16591	E643A	✓	77	405TSTFC6003	GT1245A	✓	72</

Index

Model Number/Catalog Number

INDEX

MODEL NO.	CAT. NO.	STOCK	PAGE NO.	MODEL NO.	CAT. NO.	STOCK	PAGE NO.	MODEL NO.	CAT. NO.	STOCK	PAGE NO.	MODEL NO.	CAT. NO.	STOCK	PAGE NO.
405STFS6005	E323	✓	57	444TSTFS16002	E324	✓	57	445TSTFN6501	E615	✓	78	447TSTDN16036	U496	✓	43
405STFS6501	E613	✓	78	444TSTGN16502	U073A	✓	88	445TSTFN6502	E495	✓	78	449TSTDN16040	U796	✓	43
405STFS6502	E493	✓	78	444TSTGN16531	U083A	✓	88	445TSTFN6505	E449	✓	78	449TSTDN16041	U499	✓	43
405STFS6526	E456	✓	78	444TDC6060	GT0052	✓	51	445TSTFN6506	E496	✓	78	449TSTDN16046	U498	✓	43
405STFS14007	Y1628	✓	164	444TTDC16077	GT0047	✓	51	445TSTFN6526	E458	✓	78	447TSTDN16047	U497	✓	43
405STFS16033	E808A	✓	57	444TTDC6060	GT0052A	✓	51	445TSTFN6528	E459	✓	78	447TSTFC6005	GT1154	✓	68
405STGS6503	E578	✓	88	444TTDC6077	GT0047A	✓	51	445TSTFN14013	Y1634	✓	165	447TSTFC16004	GT1054	✓	68
405STGS16531	U082A	✓	88	444TTDN16003	M757	✓	167	445TSTFN14014	Y1637	✓	165	447TSTFC6004	GT1054A	✓	68
405TDC6060	GT0049	✓	51	444TTDN16027	M754	✓	167	445TSTFN14066	Y1638	✓	165	447TSTFC6005	GT1154A	✓	68
405TDC16081	GT0044	✓	51	444TTDN16078	M747	✓	167	445TSTFN14067	Y1635	✓	165	447TSTFC6038	GT1066	✓	68
405TDC6060	GT0049A	✓	51	444TTDN16101	M744	✓	167	445TSTFN16004	E342	✓	57	447TDC16077	GT0053	✓	51
405TDC6081	GT0044A	✓	51	444TDS16043	U911A	✓	43	445TSTFN16033	E813A	✓	57	447TDC60677	GT0053A	✓	51
405TDS6060	E923	✓	43	444TDS16077	U272	✓	43	445TSTGN16505	E584	✓	88	447TDN16041	U789	✓	43
405TDS7697	Y211	✓	221	444TDS6060	E924	✓	43	445TSTGN16506	U075A	✓	88	447TDN16046	U786	✓	43
405TDS16010	M753	✓	167	444TDS8699	Y212	✓	221	445TSTGN16531	U084A	✓	88	447TDN16048	U794	✓	43
405TDS16060	U904A	✓	43	444TFC6036	GT1049	✓	68	445TDC6060	GT0055	✓	51	447TDN16077	U274	✓	43
405TDS16070	M750	✓	167	444TFC6044	GT1149	✓	68	445TDC16076	GT0050	✓	51	447TDN16058	E745A	✓	43
405TDS16102	M740	✓	167	444TFC6080	GT1147	✓	67	445TDC6060	GT0055A	✓	51	447TDN16083	E796A	✓	43
405TDS16081	U271	✓	43	444TFC6086	GT1047	✓	67	445TDC6076	GT0050A	✓	51	447TDN16085	E797A	✓	43
405TDS16089	M743	✓	167	444TFC6633	Y824A	✓	215	445TDC16002	M761	✓	167	447TDN16382	H822B	✓	43
405TFC6036	GT1046	✓	67	444TFC6683	Y851A	✓	215	445TDC16031	M758	✓	167	447TFC6038	GT1055	✓	68
405TFC6038	GT1246	✓	72	444TFC6036	GT1049A	✓	68	445TDC16032	M762	✓	167	447TFC6039	GT1155	✓	68
405TFC6040	GT1146	✓	67	444TFC6044	GT1149A	✓	68	445TDC16079	M755	✓	167	447TFC6080	GT1153	✓	68
405TFC6080	GT1144	✓	67	444TFC6080	GT1147A	✓	67	445TDC16080	M751	✓	167	447TFC6087	GT1053	✓	68
405TFC6086	GT1044	✓	67	444TFC6086	GT1047A	✓	67	445TDC16101	M748	✓	167	447TFC6633	Y828A	✓	215
405TFC6633	Y822B	✓	215	444TFN6044	E316A	✓	57	445TDC6060	E925	✓	43	447TFC6683	Y854A	✓	215
405TFC6683	Y852A	✓	215	444TFN6086	E328	✓	57	445TDC9477	Y213	✓	221	447TFC6038	GT1055A	✓	68
405TFC6036	GT1046A	✓	67	444TFN16001	M924B	✓	169	445TDC16041	U912A	✓	43	447TFC6039	GT1155A	✓	68
405TFC6038	GT1246A	✓	72	444TFN16045	M925B	✓	169	445TDC16076	U273	✓	43	447TFC6080	GT1153A	✓	68
405TFC6040	GT1146A	✓	67	444TFN16081	M922B	✓	169	445TDC6036	GT1052	✓	68	447TFC6087	GT1053A	✓	68
405TFC6080	GT1144A	✓	67	444TFN16102	L428A	✓	57	445TFC6037	GT1152	✓	68	449THFS8036	Y579	✓	96
405TFC6086	GT1044A	✓	67	444TFN16103	M919B	✓	169	445TFC6080	GT1150	✓	68	449THFS8037	Y580	✓	96
405TFS6036	E213	✓	57	444TFN16549	U880A	✓	73	445TFC6086	GT1050	✓	68	449THFS8046	Y531	✓	96
405TFS6040	E314	✓	57	444TFN16581	E646A	✓	78	445TFC6633	Y826B	✓	215	449THFS8047	Y532	✓	96
405TFS6086	E244	✓	57	444TFN16582	E405A	✓	78	445TFC6683	Y853A	✓	215	449THFS8048	Y533	✓	96
405TFS6536	E628	✓	78	444TFN16574	E629-P	✓	78	445TFC6036	GT1052A	✓	68	449THFS9027	W632	✓	82
405TFS6538	E681	✓	78	444TFN16577	E327	✓	78	445TFC6037	GT1152A	✓	68	449THFS9028	W626	✓	82
405TFS6586	E645	✓	78	444TFS6036	E214	✓	57	445TFC6080	GT1150A	✓	68	449THFS9030	W619	✓	82
405TFS6587	E404	✓	78	444TFS6536	E629	✓	78	445TFC6086	GT1050A	✓	68	449THFS9036	W635	✓	82
405TFS7297	Y391	✓	217	444TFS6540	E697	✓	78	445TFC6028	U669A	✓	57	449THFS9088	W622	✓	82
405TFS14328	Y1630	✓	164	444TFS7262	Y392	✓	217	445TFC6036	E215	✓	57	449THFS9101	W615	✓	81
405TFS16004	M920B	✓	169	444TGN16532	E582A	✓	88	445TFC6037	E317	✓	57	449THFS19079	W630	✓	82
405TFS16082	M918B	✓	169	444TGN16533	U036A	✓	88	445TFC6038	E247	✓	57	449THFS19091	W629	✓	82
405TFS16103	L427A	✓	57	444TGN16580	E580A	✓	88	445TFC6039	E326	✓	57	449THFS19092	W621	✓	82
405TFS16129	M921B	✓	169	444TGN16535	U1880	✓	74	445TFC6086	E246	✓	57	449THFS19342	W626-P	✓	82
405TFS16834	U879A	✓	73	445THFN8036	Y577	✓	96	445TFC6087	E289	✓	57	449THFS9001	W634	✓	82
405TFS16865	E628-P	✓	78	445THFN8040	Y578	✓	96	445TFC6536	E630	✓	78	449THFS9003	W624	✓	82
405TGS6548	E594	✓	88	445THFN8046	Y519	✓	96	445TFC6537	E682	✓	78	449TSTDN7001	H818	✓	163
405TGS6589	E577	✓	88	445THFN8050	Y520	✓	96	445TFC6538	E631	✓	78	449TSTDN7027	H816	✓	163
405TGS16539	U035A	✓	88	445THFN9036	W612	✓	81	445TFC6596	E647	✓	78	449TSTDN14005	H819A	✓	163
405TTS16537	U1879	✓	74	445THFN9037	W613	✓	81	445TFC6587	E448	✓	78	449TSTDN14033	H815A	✓	163
444THFN8036	Y576	✓	96	445THFN9038	W618	✓	82	445TFC6590	E406	✓	78	449TSTDN16003	U793	✓	43
444THFN8046	Y518	✓	96	445THFN9086	W608	✓	81	445TFC6591	E407	✓	78	449TSTDN16004	U795	✓	43
444THFN8384	Y589	✓	96	445THFN9087	W614	✓	81	445TFC6581	L429	✓	57	449TSTDN16005	U797	✓	43
444THFN19044	W606-P	✓	81	445THFN9102	W609	✓	81	445TFC14337	Y1636	✓	165	449TSTGS16506	E595A	✓	88
444THFN19081	W636	✓	81	445THFN9106	W603	✓	81	445TFC14338	Y1639	✓	165	449TSTFS6001	E273	✓	57
444THFS9036	W606	✓	81	445THFN19033	W641	✓	81	445TFC14571	Y826A	✓	215	449TSTFS6002	E272	✓	57
444THFS9040	W607	✓	81	445THFN19034	W642	✓	82	445TFC16001	M928B	✓	169	449TSTFS6003	E271	✓	57
444THFS9101	W597	✓	81	445THFN19070	W618-P	✓	82	445TFC16091	M926B	✓	169	449TSTFS6501	E769	✓	78
444THFN19002	W604A	✓	81	445THFN19071	W612-P	✓	81	445TFC16108	L440A	✓	57	449TSTFS6502	E698	✓	78
444TSTDC16003	GT0054	✓	51	445SHFN9001	W610	✓	81	445TFC16359	M933B	✓	169	449TSTFS6503	E699	✓	78
444TSTDC4008	U1127	✓	162	445SHFN9005	W616	✓	82	445TFC16361	M929B	✓	169	449TSTFS14012	Y1640	✓	165
444TSTDC4010	U536A	✓	162	445SHFN9026	W611	✓	81	445TFC16852	U882A	✓	73	449TSTFS14040	Y1641	✓	165
444TSTDC4035	U1125	✓	162	445SHFN9028	W617	✓	82	445TFC16866	U881A	✓	73	449TSTFS14044	Y1647	✓	165
444TSTDC4332	U535A	✓	162	445TSTDC4007	U539A	✓	163	445TGN6538	E588	✓	88	449TSTFS14045	Y1644	✓	165
444TSTDC6003	GT0054A	✓	51	445TSTDC4008	U1130	✓	163	445TGN6542	E585	✓	88	449TDC16076	GT0056	✓	51
444TSTDS4010	U536	✓	162	445TSTDC4035	U1128	✓	162	445TGN6597	E583	✓	88	449TDC60676	GT0056A	✓	51
444TSTDS4332	U535	✓	162	445TSTDC4036	U1131	✓	163	445TGN16543	U038A	✓	88	449TDC16076	GT0056A	✓	51
444TSTDS16034	U456A	✓	47	445TSTDC4332	U537A	✓	162	445TGN16544	U037A	✓	88	449TDC16077	GT0056	✓	51
444TSTDS16038	E792A	✓	43	445TSTDC14051	U540A	✓	163	445TGN16588	U090A	✓	88	449TFC6080	GT1156	✓	68
444TSTDS16003	U252	✓	43	445TSTDS4332	U537	✓	162	445TGN16536	U1881	✓	74	449TFC6088	GT1056	✓	68
444TSTFC6001	GT1048	✓	68	445TSTDS14007	U539	✓	163	445TGN16537	U1882	✓	74	449TFC6683	Y855B	✓	215
444TSTFC16002	GT1148	✓	68	445TSTDS14051	U540	✓	163	447TSTDN7001	H178	✓	163	449TFC6080	GT1156A	✓	68
444TSTFC6001	GT1048A	✓	68	445TSTDS16038	U400A	✓	43	447TSTDN7003	H193	✓	163	449TFC6088	GT1056A	✓	68
444TSTFC6036	GT1064	✓	68	445TSTFC6001	GT1051	✓	68	447TSTDN7005	H817	✓	163	449TSTFC6037	E277	✓	57
444TSTFC616002	GT1148A	✓	68	445TSTFC6005	GT1151	✓	68	447TSTDN7026	H812	✓	163	449TSTFC6038	E276	✓	57
444TSTFN16033	E810A	✓	57	445TSTFC6001	GT1051A	✓	68	447TSTDN7027	H813	✓	163	449TSTFC6065	E292	✓	57
444TSTFS6001	E229	✓	57	445TSTFC6005	GT1151A	✓	68	447TSTDN7028	H814	✓	163	449TSTFC6087	E283	✓	57
444TSTFS6501	E614	✓	78	445TSTFC6036	GT1065</										

MODEL NO.	CAT. NO.	STOCK	PAGE NO.	MODEL NO.	CAT. NO.	STOCK	PAGE NO.	MODEL NO.	CAT. NO.	STOCK	PAGE NO.	MODEL NO.	CAT. NO.	STOCK	PAGE NO.
449TFS6528	E771	✓	78	B176201.00	A670	✓	242	KIT 145TCN-841	A262	✓	242	KIT 280R	A728	✓	250
449TFS6530	E770	✓	78	B176202.00	A671	✓	242	KIT 180/210CB	A720	✓	249	KIT 280RFN	A727	✓	250
449TFS6536	E692	✓	78	B176203.00	A672	✓	242	KIT 180-210 TERM BLK	A1000	✓	243	KIT 280RFNA	A731	✓	250
449TFS6537	E691	✓	78	B176204.00	A673	✓	242	KIT 180CF4.5-1	A645	✓	240	KIT 280RPPA	A726	✓	250
449TFS6538	E690	✓	78	B176205.00	A675	✓	242	KIT 180CF8.5-1	A644	✓	240	KIT 280CDR	A210A	✓	239
449TFS6540	E854	✓	78	B176206.00	A676	✓	242	KIT 180R	A718	✓	250	KIT 280CD-WD	A165	✓	239
449TFS6564	E856	✓	78	B176207.00	A678	✓	242	KIT 180TCD-WD	A160	✓	239	KIT 280TCD2-WD	A164	✓	239
449TFS6577	E774	✓	78	B176209.00	A935	✓	249	KIT 180TCF-WD	A170	✓	240	KIT 280TCCD	A287	✓	239
449TFS6578	E773	✓	78	B176210.00	A936	✓	249	KIT 180TCN4.5	A640	✓	240	KIT 280TCCDA	A1287	✓	239
449TFS6582	E408	✓	78	B176211.00	A937	✓	249	KIT 180TCN8.5	A641	✓	240	KIT 280TCCDP	A610	✓	239
449TFS6587	E688	✓	78	B176212.00	A938	✓	249	KIT 180TCFS-841	A182	✓	242	KIT 280TCF-WD	A175	✓	241
449TFS6588	E687	✓	78	B176213.00	A939	✓	249	KIT 180TDFR	A630	✓	242	KIT 280TCF2-WD	A174	✓	241
449TFS8110	L449	✓	57	B176214.00	A092	✓	248	KIT 180U	1814T	✓	254	KIT 280TCFN	A615	✓	241
449TFS8111	L442	✓	57	B176215.00	A093	✓	248	KIT 182SB	182A	✓	254	KIT 280TCFN-841	A185	✓	242
449TFS14055	Y1642	✓	165	B176217.00	A095	✓	248	KIT 184SB	184A	✓	254	KIT 280TCFNA	A618	✓	241
449TFS14056	Y1648	✓	165	B176218.00	A096	✓	248	KIT 197	A197	✓	248	KIT 280TCFNA-841	A186	✓	242
449TFS14057	Y1645	✓	165	B176219.00	A097	✓	248	KIT 198	A198	✓	248	KIT 280TCFP	A611	✓	241
449TFS16094	E814A	✓	57	B176220.00	A098	✓	248	KIT 199	A199	✓	248	KIT 280TCFPA	A617	✓	241
449TFS16102	L471A	✓	57	B176221.00	A099	✓	248	KIT 202	A202	✓	248	KIT 280TDFNA	A656	✓	242
449TFS16106	M931B	✓	169	B176222.00	A082	✓	248	KIT 201	A201	✓	248	KIT 280TDFP	A631	✓	242
449TFS16333	E293	✓	57	B176224.00	A084	✓	248	KIT 210TCD-WD	A161	✓	239	KIT 280U	28U25T	✓	254
449TFS16334	E291	✓	57	B176225.00	A085	✓	248	KIT 210TCDW	A606	✓	239	KIT 281	A281	✓	245
449TFS16362	L455A	✓	57	B176226.00	A086	✓	248	KIT 210TCF-WD	A171	✓	240	KIT 282	A282	✓	245
449TFS16364	L496B	✓	57	B176227.00	A087	✓	248	KIT 210TCFCD-WD	A421	✓	240	KIT 283	A283	✓	245
449TFS16365	L472A	✓	57	B176228.00	A088	✓	248	KIT 210TCFL	A204	✓	240	KIT 284SB	284B2	✓	254
449TFS16374	L4633A	✓	57	B176237.00	A972	✓	249	KIT 210TCFS	A206	✓	240	KIT 286SB	286B2	✓	254
449TFS16384	L457A	✓	57	B176238.00	A973	✓	249	KIT 210TCFS-841	A183	✓	242	KIT 308	A308	✓	245
449TFS16385	L465A	✓	57	B176239.00	A974	✓	249	KIT 210TCFW	A609	✓	240	KIT 311	A311	✓	248
449TFS16426	E329	✓	57	B176240.00	A420	✓	240	KIT 210TCN	A646	✓	240	KIT 320CB	A730	✓	249
449TFS16534	E345	✓	78	B176241.00	A091	✓	248	KIT 210R	A721	✓	250	KIT 320RPPA	A733	✓	250
449TFS16553	E776	✓	78	B176242.00	A933	✓	249	KIT 210U	2118T	✓	254	KIT 320TCDR	A213	✓	239
449TFS36633	Y856A	✓	215	B176243.00	A976	✓	249	KIT 213SB	213A	✓	254	KIT 320TCD-WD	A167	✓	239
449TFS36649	U884A	✓	73	E56Y22TFC2050	SI202	✓	98	KIT 215SB	215A	✓	254	KIT 320TCD2-WD	A166	✓	239
449TGS16537	E591	✓	88	E56Y22TFC2051	SI203	✓	98	KIT 234	A234	✓	248	KIT 320TCCP	A613	✓	239
449TGS16554	E596	✓	88	E56Y22TFC2052	SI204	✓	98	KIT 240	A240	✓	245	KIT 320TCF-WD	A177	✓	241
449TGS16557	H504A	✓	88	E56Y42TFC2050	SI402	✓	98	KIT 241	A241	✓	245	KIT 320TCF2-WD	A176	✓	241
449TGS16585	U091A	✓	88	E56Y42TFC2051	SI403	✓	98	KIT 242	A242	✓	245	KIT 320TCFP	A614	✓	241
449TTS16539	U1884	✓	74	E56Y42TFC2052	SI404	✓	98	KIT 243	A243	✓	246	KIT 320TCFPA	A619	✓	241
505UTDS1584	Y219	✓	221	KIT 391-200-01	A000	✓	250	KIT 244	A244	✓	246	KIT 320TCFS	A194	✓	241
505UTDS1590	Y220	✓	221	KIT 391-200-02	A001	✓	250	KIT 245	A245	✓	246	KIT 320TCFS-841	A187	✓	242
505UTDS16101	M760	✓	167	KIT 3BRK1	A306	✓	244	KIT 247	A247	✓	248	KIT 320TDFP	A632	✓	242
505UTDS16102	M752	✓	167	KIT 3BRK3	A301	✓	244	KIT 248	A248	✓	248	KIT 320TDFPA	A657	✓	242
505UTDS16103	M756	✓	167	KIT 3BRK3A	A297	✓	244	KIT 249	A249	✓	246	KIT 320TDFS	A658	✓	242
505UTDS16076	M759	✓	167	KIT 6BRK1	A307	✓	244	KIT 250	A250	✓	246	KIT 320U	32U28T	✓	254
508UTDS16077	H821B	✓	43	KIT 6BRK3	A302	✓	244	KIT 250-320 TERM BLK	A1001	✓	243	KIT 324SB	324B2	✓	254
508UTDS16078	M763	✓	167	KIT 6BRK3A	A298	✓	244	KIT 250CB	A722	✓	249	KIT 326SB	326B2	✓	254
5011LSTFS16031	E364	✓	78	KIT 10BRK	A303	✓	244	KIT 250CCD-WD	A083	✓	248	KIT 364-445CB	A119	✓	249
5011LSTFS16033	E366	✓	78	KIT 10BRKA	A299	✓	244	KIT 250R	A725	✓	250	KIT 360BFRSR-314	A755	✓	251
5013LSTFS6595	E363	✓	78	KIT 21TEBC	A692	✓	251	KIT 250RFNA	A724	✓	250	KIT 360 TERM BLK	A1002	✓	243
976B399AAP9	A950	✓	250	KIT 25TEBCNA	A691	✓	251	KIT 250RPPA	A723	✓	250	KIT 360TCD-WD	A169	✓	239
976B399AAP12	A951	✓	250	KIT 28TEBCNA	A701	✓	251	KIT 250TCD-WD	A163	✓	239	KIT 360TCD2-WD	A168	✓	239
976B399AAP13	A952	✓	250	KIT 32TEBC	A695	✓	251	KIT 250TCD2-WD	A162	✓	239	KIT 360TCD5	A216	✓	239
976B399ABP6	A953	✓	250	KIT 36TEBC	A696	✓	251	KIT 250TCDX	A612	✓	239	KIT 360TCF-WD	A179	✓	241
976B399ABP9	A954	✓	250	KIT 40TEBC	A697	✓	251	KIT 250TCF-WD	A173	✓	241	KIT 360TCF2-WD	A178	✓	241
976B399ABP10	A955	✓	250	KIT 44TEBC-313	A698	✓	251	KIT 250TCF2-WD	A172	✓	240	KIT 360TCFS	A197	✓	241
B176026.00	A173A	✓	241	KIT 44TEBC-316	A699	✓	251	KIT 250TCL	A209	✓	241	KIT 360TCFSR	A395	✓	241
B176028.00	A175A	✓	241	KIT 44TEBC-318	A700	✓	251	KIT 250TCL-R	A1209	✓	241	KIT 360TCFSR-841	A188	✓	242
B176030.00	A177A	✓	241	KIT 56CDR-1	A435	✓	239	KIT 250TCFNA	A284	✓	241	KIT 360TDFC	A637	✓	242
B176032.00	A179A	✓	241	KIT 56CFR-1	A437	✓	240	KIT 250TCFNA-841	A184	✓	242	KIT 360TSCDS	A219	✓	239
B176034.00	A424A	✓	241	KIT 56 EXPR BOX	A800	✓	249	KIT 250TCFP	A601	✓	241	KIT 360TSCFSR	A396	✓	241
B176035.00	A425A	✓	241	KIT 100	A100	✓	246	KIT 250TCFPA	A239	✓	241	KIT 360TSCFSR-841	A189	✓	242
B176036.00	A426A	✓	241	KIT 103	A103	✓	253	KIT 250TDFNA	A648	✓	242	KIT 360U	36U32T	✓	254
B176037.00	A427A	✓	241	KIT 104	A104	✓	245	KIT 250TDFPA	A647	✓	242	KIT 364SB	364B2	✓	254
B176066.00	A162A	✓	239	KIT 105	A105	✓	247	KIT 250U	25U21T	✓	254	KIT 365SB	365B2	✓	254
B176067.00	A163A	✓	239	KIT 106	A106	✓	247	KIT 251	A251	✓	246	KIT 370-3	A371	✓	246
B176068.00	A164A	✓	239	KIT 107-637	A107	✓	245	KIT 252	A252	✓	246	KIT 370-4	A372	✓	246
B176069.00	A165A	✓	239	KIT 109	A109	✓	253	KIT 253	A253	✓	246	KIT 370-5	A373	✓	246
B176070.00	A166A	✓	239	KIT 110	A110	✓	245	KIT 254	A254	✓	246	KIT 370-7.5	A375	✓	246
B176071.00	A167A	✓	239	KIT 111	A111	✓	246	KIT 254SB	254B2	✓	254	KIT 370-10	A376	✓	246
B176072.00	A168A	✓	239	KIT 112	A112	✓	245	KIT 256	A256	✓	247	KIT 370-15	A378	✓	246
B176073.00	A169A	✓	239	KIT 113	A113	✓	245	KIT 256SB	256B2	✓	254	KIT 370-17.5	A379	✓	246
B176074.00	A414A	✓	239	KIT 114	A114	✓	245	KIT 257	A257	✓	247	KIT 370-20	A380	✓	246
B176075.00	A415A	✓	240	KIT 116	A116	✓	253	KIT 258	A258	✓	247	KIT 370-25	A381	✓	246
B176076.00	A416A	✓	240	KIT 140CB	A715	✓	250	KIT 259	A259	✓	246	KIT 370-30	A382	✓	246
B176077.00	A417A	✓	240	KIT 140TCDR-1	A436	✓	239	KIT 261	A261	✓	249	KIT 400-445 TERM BLK	A1003	✓	243
B176194.00	A677	✓	242	KIT 140TCFR-1	A438	✓	240	KIT 277	A277	✓	246	KIT 400BFRS-316	A756	✓	251
B176196.00	A980	✓	249	KIT 143SB	143A	✓	254	KIT 278	A278	✓	246	KIT 400TCD-WD	A414	✓	240
B176197.00	A981	✓	249	KIT 143TCFN	A603	✓	240	KIT 279	A279	✓	245	KIT 400TCD2-WD	A415	✓	239
B176198.00	A982	✓	249	KIT 143TCN-841	A181	✓	242	KIT 280	A280	✓	245	KIT 400TCD5	A202	✓	240
B176199.00	A983	✓	249	KIT 145SB	145A	✓	254	KIT 280CB	A729	✓	249	KIT 400TCFS	A223	✓	241
B176200.00	A984	✓	249	KIT 145TCFN	A655	✓	240	KIT 280DCF-WD	A094	✓	248	KIT 400TCFS-841	A190	✓	242

Index

Model Number/Catalog Number

INDEX

MODEL NO.	CAT. NO.	STOCK	PAGE NO.	MODEL NO.	CAT. NO.	STOCK	PAGE NO.	MODEL NO.	CAT. NO.	STOCK	PAGE NO.	MODEL NO.	CAT. NO.	STOCK	PAGE NO.
KIT 400TCF-WD	A425	✓	241	KIT 175827	A555B	✓	243	KIT HS25A1024-NV	A746	✓	252				
KIT 400TCF2-WD	A424	✓	241	KIT 175828	A550	✓	243	KIT HS25A2048-NV	A747	✓	252				
KIT 400TDFS	A634	✓	242	KIT 175829	A551	✓	243	KIT HS351024-BC	A775	✓	252				
KIT 400TSCDS	A225	✓	239	KIT 175830	A552	✓	243	KIT HS351024-FC	A774	✓	252				
KIT 400TSCFS	A226	✓	241	KIT 175831	A553	✓	243	KIT HS351024-NV	A772	✓	252				
KIT 400TSCFS-841	A191	✓	242	KIT 175832	A582B	✓	243	KIT HS352048-BC	A778	✓	252				
KIT 400U	40U361	✓	254	KIT 175833	A589	✓	243	KIT HS352048-FC	A777	✓	252				
KIT 404SB	404B2	✓	254	KIT 175834	A590	✓	243	KIT HS352048-NV	A776	✓	252				
KIT 405SB	405B2	✓	254	KIT 175835	A596	✓	243	KIT HS35A1024-BC	A738	✓	252				
KIT 440-7.5	A445	✓	246	KIT 175836	A598	✓	243	KIT HS35A1024-FC	A737	✓	252				
KIT 440-10	A446	✓	246	KIT 175837	A593	✓	243	KIT HS35A1024-NV	A736	✓	252				
KIT 440-12.5	A447	✓	246	KIT 175844	A667	✓	240	KIT HS35A2048-FC	A740	✓	252				
KIT 440-15	A448	✓	246	KIT 175890	A558	✓	243	KIT HS35A2048-NV	A739	✓	252				
KIT 440-17.5	A449	✓	246	KIT 175900	A585	✓	243	KIT HS35B1024-BC	A781	✓	252				
KIT 440BBFN	A760	✓	251	KIT 175901	A586	✓	243	KIT HS35B1024-FC	A783	✓	252				
KIT 440BRFN	A759	✓	251	KIT 175902	A587	✓	243	KIT HS35B1024-NV	A779	✓	252				
KIT 440BRFS-318	A757	✓	251	KIT 175903	A588	✓	243	KIT HS35B2048-BC	A782	✓	252				
KIT 440TSCDS	A228	✓	240	KIT 175984	A554	✓	243	KIT HS35B2048-FC	A784	✓	252				
KIT 440TCFN	A620	✓	241	KIT 175985	A581	✓	243	KIT HS35B2048-NV	A780	✓	252				
KIT 440TCFN-841	A194	✓	242	KIT 175986	A555	✓	243	KIT HS35M1024	A742	✓	252				
KIT 440TCFS	A229	✓	241	KIT 175987	A582	✓	243	KIT HS35M2048	A744	✓	252				
KIT 440TCFS-841	A192	✓	242	KIT 175988	A556	✓	243	KIT HS35A/B1024-FC	A783A	✓	252				
KIT 440TSCDN	A293	✓	240	KIT 175989	A583	✓	243	KIT HS35A/B2048-FC	A784A	✓	252				
KIT 440TSCDS	A231	✓	240	KIT 175990	A557	✓	243	KIT HS35A/B1024-NV	A779A	✓	252				
KIT 440TSCFN	A621	✓	241	KIT 175991	A584	✓	243	KIT HS35A/B2048-NV	A780A	✓	252				
KIT 440TSCFN-841	A195	✓	242	KIT 175994	A559	✓	243	KIT HSD351024-FC	A712	✓	252				
KIT 440TSCFS	A232	✓	241	KIT 175995	A580	✓	243	KIT HSD351024-NV	A711	✓	252				
KIT 440TSCFS-841	A193	✓	242	KIT 631475	A561	✓	243	KIT HS451024-FC	A754A	✓	252				
KIT 440U	44U40T	✓	254	KIT 635115	A569	✓	243	KIT HS451024-NV	A753A	✓	252				
KIT 444SB	444B2	✓	254	KIT 711485	A562	✓	243	KIT L49BBFS-322	A795	✓	251				
KIT 444/5TCD-WD	A417	✓	240	KIT 715130	A570	✓	243	KIT L49TEBC	A796	✓	251				
KIT 444/5TCD2-WD	A416	✓	240	KIT 805165	A571	✓	243	KIT LDRDCR-M	A803	✓	249				
KIT 444/5TCF-WD	A427	✓	241	KIT 905165	A572	✓	243	KIT LKSR02	A763	✓	252				
KIT 444/5TCF2-WD	A426	✓	241	KIT 1005215	A573	✓	243	KIT LKSR03	A764	✓	252				
KIT 445SB	445B2	✓	254	KIT 1125215	A574	✓	243	KIT LKSR512	A785	✓	252				
KIT 447/9TCD-WD	A419	✓	240	KIT 1325265	A575	✓	243	KIT LKSR-CFACE	A786	✓	252				
KIT 447/9 TERM BLK	A1004	✓	243	KIT 1605300	A576	✓	243	KIT M31024-FC	A754	✓	252				
KIT 447/9TCF-WD	A429	✓	241	KIT 1805300	A577	✓	243	KIT M31024-NV	A753	✓	252				
KIT 447/9TCF2-WD	A428	✓	241	KIT 2005350	A578	✓	243	KIT M561024-BC	A794	✓	252				
KIT 447SB	447B2	✓	254	KIT 2255400	A579	✓	243	KIT M561024BRK-140	A748	✓	252				
KIT 449BBFS	A761	✓	251	KIT 8014100	A563	✓	243	KIT M561024BRK-182	A749	✓	252				
KIT 449BBFS-319	A788	✓	251	KIT 9014115	A564	✓	243	KIT M561024-NV	A793	✓	252				
KIT 449BBFS-322	A787	✓	251	KIT 10014130	A565	✓	243	KIT M851024BRK-184	A750	✓	252				
KIT 449BRFS	A758	✓	251	KIT 11214130	A566	✓	243	KIT M851024BRK-210	A751	✓	252				
KIT 449SB	449B2	✓	254	KIT 13214165	A567	✓	243	KIT M851024BRK-250	A752	✓	252				
KIT 449TCFS	A623	✓	241	KIT 16014215	A568	✓	243	KIT SGR-0.625-UK	A499-1	✓	253				
KIT 449TSCFS-1	A624	✓	241	KIT A02H1024-BC LED	A668	✓	252	KIT SGR-0.875-UK	A499-2	✓	253				
KIT 449TSCFS-2	A625	✓	241	KIT A02H2048-BC LED	A669	✓	252	KIT SGR-1.125-UK	A499-3	✓	253				
KIT 649R	A649	✓	242	KIT AV321024-FC	A1014	✓	252	KIT SGR-1.375-UK	A499-4	✓	253				
KIT 650R	A650	✓	242	KIT AV322048-FC	A1015	✓	252	KIT SGR-1.625-UK	A499-5	✓	253				
KIT 651R	A651	✓	242	KIT AV32B1024-FC	A1016	✓	252	KIT SGR-1.875-UK	A499-6	✓	253				
KIT 903	A903	✓	244	KIT AV32B2048-FC	A1017	✓	252	KIT SGR-2.125-UK	A499-7	✓	253				
KIT 904	A904	✓	244	KIT AV321024-NV	A1010	✓	252	KIT SGR-2.375-UK	A499-8	✓	253				
KIT 905	A905	✓	244	KIT AV322048-NV	A1011	✓	252	KIT SGR-2.875-UK	A499-9	✓	253				
KIT 906	A906	✓	244	KIT AV32B1024-NV	A1012	✓	252	KIT SGR-3.375-UK	A499-10	✓	253				
KIT 907	A907	✓	244	KIT AV32B2048-NV	A1013	✓	252	KIT SGR-3.375-1A4-UK	A495-10	✓	253				
KIT 908	A908	✓	244	KIT AV56512-NV	A713	✓	252	KIT SGR-11.2	A500-5	✓	253				
KIT 909	A909	✓	244	KIT AV561024-BC	A794A	✓	252	KIT SGR-14.4	A500-8	✓	253				
KIT 910	A910	✓	244	KIT AV561024BRK-140	A748A	✓	252	KIT SGR-20.7	A500-14	✓	253				
KIT 911	A911	✓	244	KIT AV561024BRK-182	A749A	✓	252	KIT SGR-27.1	A500-20	✓	253				
KIT 175058	A626	✓	239	KIT AV851024BRK-184	A750A	✓	252	KIT SGR-33.4	A500-26	✓	253				
KIT 175059	A627	✓	239	KIT AV851024BRK-210	A751A	✓	252	KIT SGR-39.8	A500-32	✓	253				
KIT 175060	A628	✓	239	KIT AV851024BRK-250	A752A	✓	252	KIT SGR-43.0	A500-35	✓	253				
KIT 175061	A654	✓	241	KIT A688-10	A688-10	✓	252	KIT SGR-46.1	A500-38	✓	253				
KIT 175066	A602	✓	239	KIT A688-20	A688-20	✓	252	KIT SGR-52.5	A500-44	✓	253				
KIT 175067	A622	✓	239	KIT A688-25	A688-25	✓	252	KIT SGR-58.8	A500-50	✓	253				
KIT 175068	A652	✓	240	KIT A688-30	A688-30	✓	252	KIT SGR-71.5	A500-62	✓	253				
KIT 175077	A642	✓	240	KIT A688-50	A688-50	✓	252	KIT SGR-84.2	A500-74	✓	253				
KIT 175181	A600	✓	239	KIT A688-60	A688-60	✓	252	KIT SL561024-182NV	A789	✓	252				
KIT 175191	A653	✓	241	KIT A688-100	A688-100	✓	252	KIT SL851024-184NV	A790	✓	252				
KIT 175296	A643	✓	240	KIT A690-15	A690-15	✓	252	KIT SL851024-210NV	A791	✓	252				
KIT 175601	A629	✓	239	KIT BM6BRK	A312	✓	244	KIT SL851024-250NV	A792	✓	252				
KIT 175614	A662	✓	248	KIT BM6BRK115	A317	✓	244	KIT ST561024-182NV	A789A	✓	252				
KIT 175619	A594	✓	243	KIT BM6BRK575	A315	✓	244	KIT ST851024-184NV	A790A	✓	252				
KIT 175691	A666	✓	240	KIT BM10BRK	A313	✓	244	KIT ST851024-210NV	A791A	✓	252				
KIT 175810	A554A	✓	243	KIT BM10BRK115	A318	✓	244	KIT ST851024-250NV	A792A	✓	252				
KIT 175811	A555A	✓	243	KIT BM10BRK575	A316	✓	244	KIT STUBSHAFT 1IN	A807	✓	253				
KIT 175812	A556A	✓	243	KIT ENCB0X	A801	✓	252	KIT VRT87BRK	A157	✓	244				
KIT 175817	A581A	✓	243	KIT EP2400	A496	✓	253								
KIT 175818	A582A	✓	243	KIT EPC260 2048	A686	✓	252								
KIT 175819	A583A	✓	243	KIT HS201024-NV	A687	✓	252								

WARNINGS AND CAUTIONS

ELECTRICAL

SAFETY

Safety is emphasized throughout this catalog. These are safety alert symbols and signal words. They alert the user to potential personal injury hazards. Obey all safety messages to avoid possible injury or death or damage to equipment and other property.

⚠ WARNING WARNING indicates a hazardous situation which, if not avoided, could result in death or serious injury.

⚠ CAUTION CAUTION indicates a hazardous situation which, if not avoided, could result in minor or moderate injury.

IMPORTANT INFORMATION; PLEASE READ CAREFULLY

This catalog is not intended to provide operational instructions. Appropriate instructions provided with the motor and precautions attached to the motor should be read carefully prior to installation, operation and/or maintenance of the equipment. Injury to personnel or motor failure may be caused by improper installation, maintenance or operation.

The following **WARNING** and **CAUTION** information is supplied to you for your protection and to provide you with many years of trouble free and safe operation of your product:

⚠ WARNING

Each item below identifies a hazardous situation which, if not avoided, could result in death or serious injury. Failure to follow the instructions and precautions listed below could result in personal injury or damage to equipment.

- Disconnect power and lock out driven equipment before working on a motor.
- Keep hands and clothing away from moving parts.
- The lifting support on the motor is not to be used to lift the entire machine. Only the motor attached directly to the support may be safely lifted by the support.
- Install and ground per local and national codes.
- Discharge all capacitors before servicing a single phase motor.
- Misapplication of a motor in hazardous environments can cause fire or an explosion and result in serious injury. Only the end user, local authority having jurisdiction, and/or insurance underwriter are qualified to identify the appropriate class(es), group(s), division(s), and temperature code(s) that applies(y) in a hazardous environment. Regal personnel cannot evaluate or recommend what motors may be suitable for use in hazardous environments. If a motor is name plated for hazardous locations, do not operate the motor without all of the grease and drain plugs installed.
- Never attempt to measure the temperature rise of a motor by touch. Temperature rise must be measured by thermometer, resistance, imbedded detector or thermocouple.
- Motors with automatic reset thermal protectors will automatically restart when the protector temperature drops sufficiently. Do not use motors with automatic reset thermal protectors in applications where automatic restart will be hazardous to personnel or equipment.
- Motors with manual reset thermal protectors may start unexpectedly after the protector trips when the surrounding air is at +20° Fahrenheit or lower. If the manual reset protector trips, disconnect motor from its power supply. After the protector cools (five minutes or more), it can be reset and power may be applied to the motor.
- Connect all protective device leads, marked P1, P2, etc., per instructions supplied with the motor.
- Operation of a motor at other than its nameplate rating may result in fire, damage to equipment or serious injury to personnel.
- For safety, buyer or user should provide protective guards over all shaft extensions and any moving apparatus mounted thereon. The user is responsible for checking all applicable safety codes in his area and providing suitable guards. Failure to do so may result in bodily injury and/or damage to equipment.

WARNINGS AND CAUTIONS

ELECTRICAL

IMPORTANT INFORMATION CONTINUED PLEASE READ CAREFULLY

CAUTION

Each item below identifies a hazardous situation which, if not avoided, could result in minor or moderate injury. Failure to follow the instructions and precautions listed below could result in personal injury or damage to equipment.

- Consult qualified personnel with questions and all electrical repairs must be performed by trained and qualified personnel only.
- For motors nameplated as “belted duty only,” do not operate the motor without belts properly installed.
- Motors and/or driven equipment should not be operated faster than their rated speed.
- For inverter applications, follow the inverter manufacturer’s installation guidelines.
- Make sure the motor is properly secured and aligned before operation.

In the event of the resale of any of the goods, in whatever form, Resellers/Buyers will include the following language in a conspicuous place and in a conspicuous manner in a written agreement covering such sale:

THE MANUFACTURER MAKES NO WARRANTY OR REPRESENTATIONS, EXPRESS OR IMPLIED, BY OPERATION OF LAW OR OTHERWISE, AS TO THE MERCHANTABILITY OR FITNESS FOR A PARTICULAR PURPOSE OF THE GOODS SOLD HEREUNDER. BUYER ACKNOWLEDGES THAT IT ALONE HAS DETERMINED THAT THE GOODS PURCHASED HEREUNDER WILL SUITABLY MEET THE REQUIREMENTS OF THEIR INTENDED USE. IN NO EVENT WILL THE MANUFACTURER BE LIABLE FOR CONSEQUENTIAL, INCIDENTAL OR OTHER DAMAGES. EVEN IF THE REPAIR OR REPLACEMENT REMEDY SHALL BE DEEMED TO HAVE FAILED OF ITS ESSENTIAL PURPOSE UNDER SECTION 2-719 OF THE UNIFORM COMMERCIAL CODE, THE MANUFACTURER SHALL HAVE NO LIABILITY TO BUYER FOR CONSEQUENTIAL DAMAGES.

Resellers/Buyers agree to also include this entire document, including the warnings and cautions above, in a conspicuous place and in a conspicuous manner in writing to instruct users on the safe usage of the product.

This information should be read together with all other printed information supplied by Regal.

For more information contact: Regal Beloit America, Inc., 100 East Randolph St., P.O. Box 8003, Wausau, WI 54402-8003

Phone: 715-675-3311

WARNINGS / CAUTIONS

WARNINGS AND CAUTIONS

MECHANICAL

IMPORTANT INFORMATION PLEASE READ CAREFULLY

The following **WARNING** and **CAUTION** information is supplied to you for your protection and to provide you with many years of trouble free and safe operation of your product:

Read ALL instructions prior to operating reducer. Injury to personnel or reducer failure may be caused by improper installation, maintenance or operation.

WARNING

Each item below identifies a hazardous situation which, if not avoided, could result in death or serious injury. Failure to follow the instructions and precautions listed below could result in personal injury or damage to equipment.

- Written authorization from Regal is required to operate or use reducers in man lift or people moving devices.
- Check to make certain application does not exceed the allowable load capacities published in the current catalog.
- Buyer shall be solely responsible for determining the adequacy of the product for any and all uses to which buyer shall apply the product. The application by buyer shall not be subject to any implied warranty of fitness for a particular purpose.
- For safety, buyer or user should provide protective guards over all shaft extensions and any moving apparatus mounted thereon. The User is responsible for checking all applicable safety codes in his area and providing suitable guards. Failure to do so may result in bodily injury and/or damage to equipment.
- Hot oil and reducers can cause severe burns. Use extreme care when removing lubrication plugs and vents.
- Make certain that the power supply is disconnected before attempting to service or remove any components. Lock out the power supply and tag it to prevent unexpected application of power.
- Reducers are not to be considered fail safe or self-locking devices. If these features are required, a properly sized, independent holding device should be utilized. Reducers should not be used as a brake.
- Any brakes that are used in conjunction with a reducer must be sized or positioned in such a way so as to not subject the reducer to loads beyond the catalog rating.
- Lifting supports including eyebolts are to be used for vertically lifting the gearbox only and no other associated attachments or motors.
- Use of an oil with an EP additive on units with backstops may prevent proper operation of the backstop. Injury to personnel, damage to the reducer or other equipment may result.
- Overhung loads subject shaft bearings and shafts to stress which may cause premature bearing failure and/or shaft breakage from bending fatigue, if not sized properly.

CAUTION

Each item below identifies a hazardous situation which, if not avoided, could result in minor or moderate injury. Failure to follow the instructions & precautions listed below could result in damage to equipment or personal injury.

- Test run unit to verify operation. If the unit tested is a prototype, that unit must be of current production.
- If the speed reducer cannot be located in a clear and dry area with access to adequate cooling air supply, then precautions must be taken to avoid the ingestion of contaminants such as water and the reduction in cooling ability due to exterior contaminants.
- Mounting bolts should be routinely checked to ensure that the unit is firmly anchored for proper operation.

In the event of the resale of any of the goods, in whatever form, resellers/buyers will include the following language in a conspicuous place and in a conspicuous manner in a written agreement covering such sale:

THE MANUFACTURER MAKES NO WARRANTIES OR REPRESENTATIONS, EXPRESS OR IMPLIED, BY OPERATION OF LAW OR OTHERWISE, AS TO THE MERCHANTABILITY OR FITNESS FOR A PARTICULAR PURPOSE OF THE GOODS SOLD HEREUNDER. BUYER ACKNOWLEDGES THAT IT ALONE HAS DETERMINED THAT THE GOODS PURCHASED HEREUNDER WILL SUITABLY MEET THE REQUIREMENTS OF THEIR INTENDED USE. IN NO EVENT WILL THE MANUFACTURER BE LIABLE FOR CONSEQUENTIAL, INCIDENTAL OR OTHER DAMAGES. EVEN IF THE REPAIR OR REPLACEMENT REMEDY SHALL BE DEEMED TO HAVE FAILED OF ITS ESSENTIAL PURPOSE UNDER SECTION 2-719 OF THE UNIFORM COMMERCIAL CODE, THE MANUFACTURER SHALL HAVE NO LIABILITY TO BUYER FOR CONSEQUENTIAL DAMAGES.

Resellers/buyers will include this entire document, including the warnings and cautions above, in a conspicuous place and in a conspicuous manner in writing to instruct users on the safe usage of the product. This information should be read together with all other printed information supplied by Regal.

NEMA® MG-1 TABLE 12-11

FULL LOAD EFFICIENCIES FOR 60 HZ EPACT

EFFICIENT ELECTRIC MOTORS RATED 600 VOLTS OR LESS (RANDOM WOUND)

HP	NOMINAL FULL LOAD EFFICIENCY							
	OPEN FRAME				ENCLOSED FRAME			
	2 POLE	4 POLE	6 POLE	8 POLE	2 POLE	4 POLE	6 POLE	8 POLE
1	N/A	82.5	80.0	74.0	75.5	82.5	80.0	74.0
1 1/2	82.5	84.0	84.0	75.5	82.5	84.0	85.5	77.0
2	84.0	84.0	85.5	85.5	84.0	84.0	86.5	82.5
3	84.0	86.5	86.5	86.5	85.5	87.5	87.5	84.0
5	85.5	87.5	87.5	87.5	87.5	87.5	87.5	85.5
7 1/2	87.5	88.5	88.5	88.5	88.5	89.5	89.5	85.5
10	88.5	89.5	90.2	89.5	89.5	89.5	89.5	88.5
15	89.5	91.0	90.2	89.5	90.2	91.0	90.2	88.5
20	90.2	91.0	91.0	90.2	90.2	91.0	90.2	89.5
25	91.0	91.7	91.7	90.2	91.0	92.4	91.7	89.5
30	91.0	92.4	92.4	91.0	91.0	92.4	91.7	91.0
40	91.7	93.0	93.0	91.0	91.7	93.0	93.0	91.0
50	92.4	93.0	93.0	91.7	92.4	93.0	93.0	91.7
60	93.0	93.6	93.6	92.4	93.0	93.6	93.6	91.7
75	93.0	94.1	93.6	93.6	93.0	94.1	93.6	93.0
100	93.0	94.1	94.1	93.6	93.6	94.5	94.1	93.0
125	93.6	94.5	94.1	93.6	94.5	94.5	94.1	93.6
150	93.6	95.0	94.5	93.6	94.5	95.0	95.0	93.6
200	94.5	95.0	94.5	93.6	95.0	95.0	95.0	94.1
250	94.5	95.4	95.4	94.5	95.4	95.0	95.0	94.5
300	95.0	95.4	95.4	N/A	95.4	95.4	95.0	N/A
350	95.0	95.4	95.4	N/A	95.4	95.4	95.0	N/A
400	95.4	95.4	N/A	N/A	95.4	95.4	N/A	N/A
450	95.8	95.8	N/A	N/A	95.4	95.4	N/A	N/A
500	95.8	95.8	N/A	N/A	95.4	95.8	N/A	N/A

NEMA® TABLE 12-11

NEMA® MG-1 TABLE 12-12 FULL LOAD EFFICIENCIES FOR 60 HZ NEMA PREMIUM® (CEE)

EFFICIENT ELECTRIC MOTORS RATED 600 VOLTS OR LESS (RANDOM WOUND)

NEMA® MG-1 Table 12-12 Full Load Efficiencies for 60 Hz NEMA Premium® (CEE)								
Efficient Electric Motors Rated 600 Volts or less (Random Wound)								
HP	NOMINAL FULL LOAD EFFICIENCY							
	OPEN FRAME				ENCLOSED FRAME			
	2 POLE	4 POLE	6 POLE	8 POLE	2 POLE	4 POLE	6 POLE	8 POLE
1	77.0	85.5	82.5	75.5	77.0	85.5	82.5	75.5
1 1/2	84.0	86.5	86.5	77.0	84.0	86.5	87.5	78.5
2	85.5	86.5	87.5	86.5	85.5	86.5	88.5	84.0
3	85.5	89.5	88.5	87.5	86.5	89.5	89.5	85.5
5	86.5	89.5	89.5	88.5	88.5	89.5	89.5	86.5
7 1/2	88.5	91.0	90.2	89.5	89.5	91.7	91.0	86.5
10	89.5	91.7	91.7	90.2	90.2	91.7	91.0	89.5
15	90.2	93.0	91.7	90.2	91.0	92.4	91.7	89.5
20	91.0	93.0	92.4	91.0	91.0	93.0	91.7	90.2
25	91.7	93.6	93.0	91.0	91.7	93.6	93.0	90.2
30	91.7	94.1	93.6	91.7	91.7	93.6	93.0	91.7
40	92.4	94.1	94.1	91.7	92.4	94.1	94.1	91.7
50	93.0	94.5	94.1	92.4	93.0	94.5	94.1	92.4
60	93.6	95.0	94.5	93.0	93.6	95.0	94.5	92.4
75	93.6	95.0	94.5	94.1	93.6	95.4	94.5	93.6
100	93.6	95.4	95.0	94.1	94.1	95.4	95.0	93.6
125	94.1	95.4	95.0	94.1	95.0	95.4	95.0	94.1
150	94.1	95.8	95.4	94.1	95.0	95.8	95.8	94.1
200	95.0	95.8	95.4	94.1	95.4	96.2	95.8	94.5
250	95.0	95.8	95.8	95.0	95.8	96.2	95.8	95.0
300	95.4	95.8	95.8	95.0	95.8	96.2	95.8	95.0
350	95.4	95.8	95.8	95.0	95.8	96.2	95.8	95.0
400	95.8	95.8	95.8	95.0	95.8	96.2	95.8	95.0
450	96.2	96.2	96.2	95.0	95.8	96.2	95.8	95.0
500	96.2	96.2	96.2	95.0	95.8	96.2	95.8	95.0

NEMA® TABLE 12-12



FOOTNOTES

1	Capacitor start/capacitor run design for reduced amperage	93	Permanent split capacitor-switchless
2	Capacitor start induction run design	94	1/2" Thru -bolts, shaft end
3	Split phase design	95	Will not accept drip cover kit
4	Sleeve bearing	96	3 lead reversible, with single pole, double throw switch
5	56H, 143T, and 145T combination base with 12 mounting holes	97	D-Flange addition results in non-NEMA® "BA" dim (+1/2" than NEMA) & non-NEMA shaft ext (-1/2" than NEMA).
6	Bolt-on removable base for footless mounting option	98	Not UL listed for fire pump applications
7	Shaft extension 1-1/2" long by 1/2" diameter	99	Suitable for 2:1 CT operation
8	Shaft extension 1-7/8" long by 1/2" diameter	100	6" shaft ext with 2 flats 90° apart
9	Shaft extension 2-1/4" long by 1/2" diameter	101	Rain shield included
10	Shaft extension 2-1/4" long by 5/8" diameter	102	5/8" extended thru bolts, 1 7/8" shaft length and 1/2" shaft dia.
11	Shaft extension 2-1/4" long by 7/8" diameter	103	48/56 FR = 1/2" X 1 1/2" shaft with 5/8" shaft adapter - 48/56 slotted 3" height base
12	With rigid base	104	Shaft N-W = 2.50" with 5/8" diameter and keyway
13	F1 Mounting only, cannot reassemble to F2	105	Includes split bushing and key for 5/8" shafts. 3 thru bolts on a 4.42" dia. bolt circle
14	Will accept flange kit, see accessory section	106	5/8" dia. keyed and flatted shaft, 6" long
15	Fixed CW rotation, viewing opposite shaft (or lead end) of motor	107	5/8" keyed shaft with flat
16	Fixed CCW rotation, viewing opposite shaft (or lead end) of motor	108	5/8" keyed shaft
17	1.0 service factor	109	48Z = 5/8" dia. X 2" shaft, with 3" height
18	1.15 service factor	110	1.20 service factor
19	1.25 service factor	111	1.30 service factor
20	1.35 service factor	112	1.40 service factor
21	Double shaft extension 1-1/2" L by 1/2" dia with flat each end	113	1.50 service factor
22	Double shaft extension 1-7/8" L by 5/8" dia each end	114	1.60 service factor
23	Shaft extension 3/8" diameter	115	1.75 service factor
24	Motor will NOT accept a brake kit	116	1-3/4" thru-bolt extension on shaft-end
25	Motor will NOT accept C-face bits	117	48-56 frame mounting - 3" shaft height, sleeve and key adapter to 5/8" shaft
26	5/8" shaft adapter included	118	48-56 frame mounting - 3 1/2" shaft height, sleeve and key adapter to 5/8" shaft
27	Drip cover included	119	56Z = 1/2" shaft with flat, 1 5/8" long
28	Steel endshields	120	5/8" diameter shaft - 2.37" long.
29	End bracket weep holes with removable plugs, remove bottom plug after installation	121	5/8" diameter shaft - 3.88" long
30	Resilient ring mount, base not included	122	5/8" keyed shaft 2.31" long
31	5/8" thru-bolts, shaft end	123	56Z = 5/8" diameter keyed shaft, 2 1/8" long
32	3/4" thru bolts, shaft end	124	2 1/4" X 7/8" keyed shaft
33	Shaft ext 6" L by 5/8" diameter with full flat and key 90° apart	125	56Y = 7/8" diameter keyed shaft, 2.25" long
34	1" thru-bolts, shaft end	126	1.0 service factor at 50 HZ
35	1-1/8" thru-bolts, shaft end	127	Shaft diameter is 1/2", N=1 15/16" with .04" deep flat
36	1-1/4" thru-bolts, shaft end	128	1/2" dia. shaft - single flat
37	1-1/2" thru-bolts, shaft end	129	56Z = 1/2" flat X 1 1/2" shaft, 3 1/2" shaft height
38	2" thru-bolts, shaft end	130	56Z = 1/2" flat X 1.62" shaft, with 56 FR. base
39	No thru-bolts, shaft end	131	48Z = 1/2" flat X 1 7/8" shaft, with 48 FR base
40	Space heaters and 100 ohm platinum stator RTDs included	132	184T base, 4.5" shaft height
41	1/2" thru-bolts, opposite shaft end	133	15" leads
42	3/4" thru-bolts, opposite shaft end	134	115 volt tap off main winding to power gear drive unit
43	2-1/2" resilient rings included	135	Open shaft end bracket
44	1" thru-bolts, opposite shaft end	136	No keyway, double flat
45	60° C ambient	137	Includes 6' cord and switch
46	65° C ambient	137	Cord, plug and pull chain
47	Connected for CCW rotation (U.S. standard) facing opposite shaft end. Reversible by reconnection of leads	138	Equipped with rotation switch for easy reversibility
48	Connected for CW rotation (Canadian standard) facing opposite shaft end. Reversible by reconnection of leads	139	Equipped with provisions for mounting 4" X 4" conduit box
49	Shaft ext 1-13/16" L by 1/2" dia., & 6-3/8" mounting flange	140	Quick connect design bracket, auto overload protector

50	Designed for 50 Hz operation	141	Includes base
51	Resilient rings not included, see accessory section	142	Proofing switch included
52	1/2" x 1-7/8" shaft with 1-5/8" flat	143	303 stainless steel shaft
53	1/2" shaft with 5/8" adapter and key	144	Open dripproof
54	30 minute duty cycle, not rated for continuous duty	145	Includes 6' cord and switch
55	Shaft ext 3-13/16" L by 5/8" dia., 3.5" keyway	2:1	Suitable for 2:1 CT operation; consult "R164 rework" table for fan change pricing to upgrade to 10:1 CT
56	1-5/8" thru-bolts, shaft end	A	NEMA® design A
57	Open construction	B	NEMA design B
58	Capacitor supplied with motor	C	NEMA design C
59	TEAO construction	d	Will become build-up item when current stock is gone
60	Foot locating set screws on frame, 90° apart	E	Design incorporates electronic switch
61	10" Leads	F	Class F Insulation
62	43" Leads	H	Class H insulation
63	1-1/2" Thru-bolts, opposite shaft end	I	Reduced HP @ 120 HZ
64	50" Leads	N	Totally enclosed, non-ventilated
65	Mounting accessories and DE resilient ring not included. Use kit 161L131AB1 for resilient ring mounting.	P	BCP (Bearing Current Protection)
66	Sealed switch design	Q	"Quick connect" terminal board
67	Capacitor not included, see accessory section	S	Steel frame construction
68	Rated 60/50 hertz, 190/380 or 380 volt at next lower horsepower	V	Suitable for 10:1 CT 60 minute duty, otherwise 2:1 CT
69	50°C Ambient	X	XRI® motor, ultra high efficiency design
70	Not nameplated 50 hz	Z	56HZ with 7/8" shaft dia., 3-1/2" shaft height, and slotted 56 frame base
71	Includes length adapter bracket	AH	Conforms to GM 7EH and satisfies Ford® EM-1 and GM 7EQ
72	Usable on 200/208 volts at 1.0 service factor	AI	Class A insulation
73	No hubs	AL	Aluminum frame construction
74	Split phase/capacitor run electrical design	AQ	Conforms to GM 7EQ and satisfies Fiat Chrysler® NPEM-100, and Ford EM-1
75	C-Face addition may result in non-NEMA "BA" dim. For new "BA" dim consult chart found in modification section	BI	Class B insulation
76	C-Face addition results in non-NEMA "AH" dim (+1.2" than NEMA).	BP	Separate power supply required for blower motor
77	Frame is drilled with 3 sets of footholes, 5010, 5011, and 5012 as standard. 5009 frame drilling available as build-up	CD	Suitable for Group C
78	Frame is drilled with two sets of footholes, 5012 and 5013 standard	CF	Consult factory for accessory kit and/or modification selection
79	Ball bearings on both ends suitable for direct connection. For belted applications, refer to customer service	CT	Suitable for 20:1 CT on vector drive, continuous duty or 2000:1
80	Rolled steel fan guard on 143T-145T	ES	Energy saver design
81	24" long #18 SO 2-conductor cord exit at 11 o'clock position	F2	F2 conduit box location
82	Welded rigid base	FN	Drive has cooling fan
83	Shaft ext 1-7/8" long by 5/8" dia with 6-3/8" flange	NE	Exempt from NEMA Premium® efficiency requirement
84	NEMA 145T C-face mounting with removable 182T rigid base	NP	Does not meet NEMA Premium efficiency
85	Not tach adaptable	NS	Single shielded ball bearings
86	2:1 constant torque speed range; RTM for greater torque capability	PW	Part winding start capability
87	10:1 constant torque available as build-up, RTM for price and availability	RB	Roller bearing on shaft end for belted load only
88	182T base and shaft height, 145TC mounting face and shaft dim	SH	Space heaters
89	Threaded NPT opening in conduit box	SL	Sound level exceeds standard
90	Not UL recognized	TS	Normally closed thermostats installed
91	Suitable for use on VFD at 208 volt	VB	Vibration not met
92	7/8" thru-bolts, shaft end	VC	Voltage change device feature for quick voltage changes
93	Permanent split capacitor-switchless	YD	12 Leads for WYE-DELTA, part winding on low voltage, or across-the-line starting

Ford is a trademark of Ford Motor Company Corporation and is not controlled by Regal Beloit Corporation.
General Motors is a trademark of LLC Limited Liability Company and is not controlled by Regal Beloit Corporation.
Chrysler is a trademark of Group LLC Limited Liability Company and is not controlled by Regal Beloit Corporation.
NEMA and NEMA Premium are trademarks of National Electrical Manufacturers Association. All Rights Reserved.

IEC QUICK REFERENCE DIMENSIONAL CHART

B3 Foot-Mounted (Ridge Base)

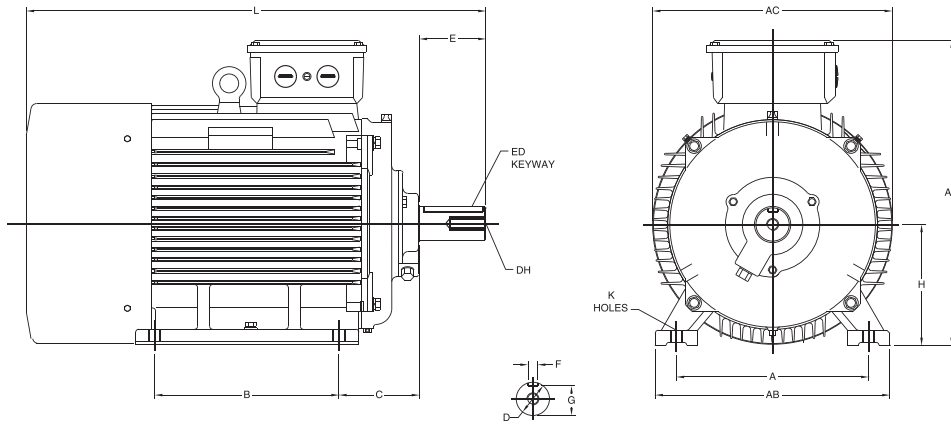

IEC Frame Dimensions (Millimeters)

FRAME	MOUNTING						SHAFT						GENERAL			B5 (FF) FLANGE						B14 (FT) FACE					
	A	B	C	H	AB	K	D	E	F	G	ED	DH	AC	AD	HD	M	N	P	S	T	LA	M	N	P	S	T	LA
63	100	80	40	63	119	7	11	23	4	8.5	10	M4 x 10	126	—	169	115	95	140	10	3.0	7	75	60	90	M5	2.5	7
71	112	90	45	71	131	7	14	30	5	11.0	20	M5 x 12.5	140	—	186	130	110	160	10	3.5	7	85	70	105	M6	2.5	9
80	125	100	50	80	157	10	19	40	6	15.5	25	M6 x 16	158	132	212	165	130	200	12	3.5	12	100	80	120	M6	3.0	9
90S	140	100	56	90	174	10	24	50	8	20.0	32	M8 x 19	178	140	230	165	130	200	12	3.5	12	115	95	140	M8	3.0	9
90L	140	125	56	90	174	10	24	50	8	20.0	32	M8 x 19	178	140	230	165	130	200	12	3.5	12	115	95	140	M8	3.0	9
100L	160	140	63	100	205	12	28	60	8	24.0	40	M10 x 22	215	178	278	215	180	250	15	4.0	11	130	110	160	M8	3.5	14
112M	190	140	70	112	245	12	28	60	8	24.0	40	M10 x 22	220	190	302	215	180	250	15	4.0	12	130	110	160	M8	3.5	11
132S	216	140	89	132	280	12	38	80	10	33.0	56	M12 x 28	275	210	342	265	230	300	15	4.0	12	165	130	200	M10	3.5	14
132M	216	178	89	132	280	12	38	80	10	33.0	56	M12 x 28	275	210	342	265	230	300	15	4.0	12	165	130	200	M10	3.5	14
160M	254	210	108	160	325	15	42	110	12	37.0	80	M16 x 36	325	254	414	300	250	350	19	5.0	13	215	180	250	M12	4.0	13
160L	254	254	108	160	325	15	42	110	12	37.0	80	M16 x 36	325	254	414	300	250	350	19	5.0	13	215	180	250	M12	4.0	13
180M	279	241	121	180	335	15	48	110	14	42.5	80	M16 x 36	360	310	490	300	250	350	19	5.0	15						
180L	279	279	121	180	335	15	48	110	14	42.5	80	M16 x 36	360	310	490	300	250	350	19	5.0	15						
200L	318	305	133	200	395	19	55	110	16	49.0	100	M20 x 42	400	340	540	350	300	400	19	5.0	19.5						
225S	356	286	149	225	435	19	55*/ 60	110*/ 140	16*/ 18	49*/ 53	100*/ 125	M20 x 42	445	414	639	400	350	450	19	5.0	21.0						
225M	356	311	149	225	435	19	55*/ 60	110*/ 140	16*/ 18	49*/ 53	100*/ 125	M20 x 42	445	414	639	400	350	450	19	5.0	21.0						
250M	406	349	168	250	490	24	60*/ 65	140	18	53*/ 58	125	M20 x 42	500	440	690	400	350	450	19	5.0	21.0						

NOT
DEFINED
BY
IEC 72

*2 Pole Dimensions

1mm = .03937", 1" = 25.4mm

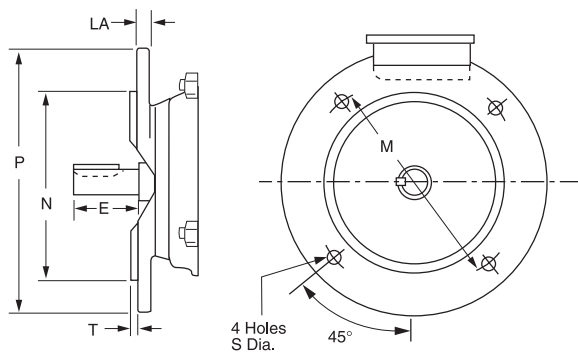

FF Flange B5 Mount

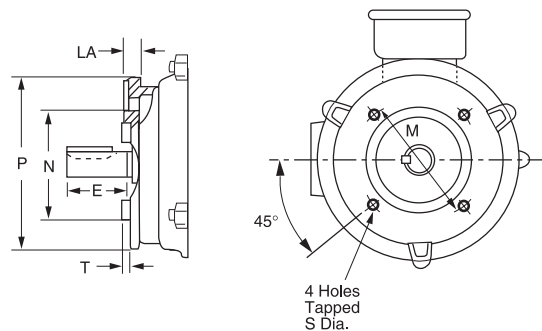

FT Face B14 Mount

NEMA Quick Reference Dimensional Chart

Typical C-Face Motor

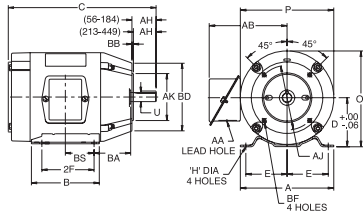

Typical Rigid Base Motor

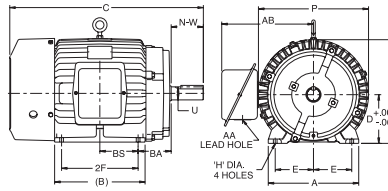

143-5TC	2-3/4
182-4TC	3-1/2
213-5TC	4-1/4
254-6TC	4-3/4

Contact your Marathon sales rep. for "AB", "O", & "P" Dim.

Refer to your Marathon catalog for "C" Dim.

FRAME	D	E	2F	H	U	N-W	AA	AH	AJ	AK	BA	BB (MIN)	BD (MAX)	BF
48	3.00	2.12	2.75	.34 SLOT	.5000	1.50	1/2	1.69	3.750	3.000	2.50	.13	5.62	1/4-20
56	3.50	2.44	3.00	.34 SLOT	.6250	1.88	1/2	2.06	5.875	4.500	2.75	.13	6.50	3/8-16
56H	3.50	2.44	5.00	.34 SLOT	.6250	1.88	1/2	2.06	5.875	4.500	2.75	.13	6.50	3/8-16
143T	3.50	2.75	4.00	.34	.8750	2.25	3/4	2.12	5.875	4.500	2.25	.13	6.50	3/8-16
145T	3.50	2.75	5.00	.34	.8750	2.25	3/4	2.12	5.875	4.500	2.25	.13	6.50	3/8-16
182	4.50	3.75	4.50	.41	.8750	2.25	3/4	2.12	5.875	4.500	2.75	.13	6.50	3/8-16
184	4.50	3.75	5.50	.41	.8750	2.25	3/4	2.12	5.875	4.500	2.75	.13	6.50	3/8-16
182T	4.50	3.75	4.50	.41	1.125	2.75	3/4	2.62	7.250	8.500	2.75	.25	9.00	1/2-13
184T	4.50	3.75	5.50	.41	1.125	2.75	3/4	2.62	7.250	8.500	2.75	.25	9.00	1/2-13
213	5.25	4.25	5.50	.41	1.125	3.00	1	2.75	7.250	8.500	3.50	.25	9.00	1/2-13
215	5.25	4.25	7.00	.41	1.125	3.00	1	2.75	7.250	8.500	3.50	.25	9.00	1/2-13
213T	5.25	4.25	5.50	.41	1.375	3.38	1	3.12	7.250	8.500	3.50	.25	9.00	1/2-13
215T	5.25	4.25	7.00	.41	1.375	3.38	1	3.12	7.250	8.500	3.50	.25	9.00	1/2-13
254U	6.25	5.00	8.25	.53	1.375	3.75	1-1/4	3.50	7.250	8.500	4.25	.25	10.00	1/2-13
256U	6.25	5.00	10.00	.53	1.375	3.75	1-1/4	3.50	7.250	8.500	4.25	.25	10.00	1/2-13
254T	6.25	5.00	8.25	.53	1.625	4.00	1-1/4	3.75	7.250	8.500	4.25	.25	10.00	1/2-13
256T	6.25	5.00	10.00	.53	1.625	4.00	1-1/4	3.75	7.250	8.500	4.25	.25	10.00	1/2-13
284U	7.00	5.50	9.50	.53	1.625	4.88	1-1/2	4.62	9.000	10.500	4.75	.25	11.25	1/2-13
286U	7.00	5.50	11.00	.53	1.625	4.88	1-1/2	4.62	9.000	10.500	4.75	.25	11.25	1/2-13
284T	7.00	5.50	9.50	.53	1.875	4.62	1-1/2	4.38	9.000	10.500	4.75	.25	11.25	1/2-13
286T	7.00	5.50	11.00	.53	1.875	4.62	1-1/2	4.38	9.000	10.500	4.75	.25	11.25	1/2-13
284TS	7.00	5.50	9.50	.53	1.625	3.25	1-1/2	3.00	9.000	10.500	4.75	.25	11.25	1/2-13
286TS	7.00	5.50	11.00	.53	1.625	3.25	1-1/2	3.00	9.000	10.500	4.75	.25	11.25	1/2-13
324U	8.00	6.25	10.50	.66	1.875	5.62	2	5.38	11.000	12.500	5.25	.25	14.00	5/8-11
326U	8.00	6.25	12.00	.66	1.875	5.62	2	5.38	11.000	12.500	5.25	.25	14.00	5/8-11
324T	8.00	6.25	10.50	.66	2.125	5.25	2	5.00	11.000	12.500	5.25	.25	14.00	5/8-11
326T	8.00	6.25	12.00	.66	2.125	5.25	2	5.00	11.000	12.500	5.25	.25	14.00	5/8-11
324TS	8.00	6.25	10.50	.66	1.875	3.75	2	3.50	11.000	12.500	5.25	.25	14.00	5/8-11
326TS	8.00	6.25	12.00	.66	1.875	3.75	2	3.50	11.000	12.500	5.25	.25	14.00	5/8-11
364U	9.00	7.00	11.25	.66	2.125	6.38	2-1/2	6.12	11.000	12.500	5.88	.25	14.00	5/8-11
365U	9.00	7.00	12.25	.66	2.125	6.38	2-1/2	6.12	11.000	12.500	5.88	.25	14.00	5/8-11
364T	9.00	7.00	11.25	.66	2.375	5.88	2-1/2	5.62	11.000	12.500	5.88	.25	14.00	5/8-11
365T	9.00	7.00	12.25	.66	2.375	5.88	2-1/2	5.62	11.000	12.500	5.88	.25	14.00	5/8-11
364TS	9.00	7.00	11.25	.66	1.875	3.75	2-1/2	3.50	11.000	12.500	5.88	.25	14.00	5/8-11
365TS	9.00	7.00	12.25	.66	1.875	3.75	2-1/2	3.50	11.000	12.500	5.88	.25	14.00	5/8-11
404U	10.00	8.00	12.25	.81	2.375	7.12	3	6.88	11.000	12.500	6.62	.25	15.50	5/8-11
405U	10.00	8.00	13.75	.81	2.375	7.12	3	6.88	11.000	12.500	6.62	.25	15.50	5/8-11
404T	10.00	8.00	12.25	.81	2.875	7.25	3	7.00	11.000	12.500	6.62	.25	15.50	5/8-11
405T	10.00	8.00	13.75	.81	2.875	7.25	3	7.00	11.000	12.500	6.62	.25	15.50	5/8-11
404TS	10.00	8.00	12.25	.81	2.125	4.25	3	4.00	11.000	12.500	6.62	.25	15.50	5/8-11
405TS	10.00	8.00	13.75	.81	2.125	4.25	3	4.00	11.000	12.500	6.62	.25	15.50	5/8-11
444U	11.00	9.00	14.50	.81	2.875	8.62	3	8.38	14.000	16.000	7.50	.25	18.00	5/8-11
445U	11.00	9.00	16.50	.81	2.875	8.62	3	8.38	14.000	16.000	7.50	.25	18.00	5/8-11
444T	11.00	9.00	14.50	.81	3.375	8.50	3	8.25	14.000	16.000	7.50	.25	18.00	5/8-11
445T	11.00	9.00	16.50	.81	3.375	8.50	3	8.25	14.000	16.000	7.50	.25	18.00	5/8-11
444TS	11.00	9.00	14.50	.81	2.375	4.75	3	4.50	14.000	16.000	7.50	.25	18.00	5/8-11
445TS	11.00	9.00	16.50	.81	2.375	4.75	3	4.50	14.000	16.000	7.50	.25	18.00	5/8-11
447T	11.00	9.00	20.00	.81	3.375	8.50	3	8.25	14.000	16.000	7.50	.25	18.00	5/8-11
449T	11.00	9.00	25.00	.81	3.375	8.50	3	8.25	14.000	16.000	7.50	.25	18.00	5/8-11
447TS	11.00	9.00	20.00	.81	2.375	4.75	4 NPT	4.50	14.000	16.000	7.50	.25	18.00	5/8-11
449TS	11.00	9.00	25.00	.81	2.375	4.75	4 NPT	4.50	14.000	16.000	7.50	.25	18.00	5/8-11

MOTORS FOR THE LONG RUN

Specifications	Features	Globetrotter® Motors	Blue Chip Series® XRI® Motors	Blue Chip Series XRI SD Motors	Blue Chip Series XRI- 841 Motors	Blue Chip Series XRI-XP Motors
Enclosures	Totally enclosed fan cooled	√	√	√	√	√
	Totally enclosed non-vented			√	√	
	Open dripproof	√	√			
Voltage	230/460 volt through 100 HP; 460 volt 125 HP and larger	√	√	√		√
	460 volt (three lead)			√	√	√
	575 volt (three lead)	√		√	√	√
Service factor (sine wave)	1.15	√	√	√	√	√
	1.25 through 40 HP (see MB0030 catalog for restrictions)		√	√	√	√
Inverter Duty	10:1 variable torque	√	√	√	√	√
	Up to 10:1 constant torque	√	√	√	√	√
	Up to 20:1 constant torque		√	√	√	√
	Provisions to add hollow shaft encoder (TEFC only)			√	√	√
Insulation System	Class F, Non-hygroscopic system 184T-449T	√		√	√	√
	Class F, Non-hygroscopic system 143T-445T, Class H 447/9T		√	√	√	√
	Max Guard® motor				√	√
Balance	Special balance average 0.08 in/sec.			√	√	√
Bearings & Lubrication	Shielded ball bearings, C-3 fit with premium Mobil Polyrex® EM grease (-30°C to +150°C)	√	√	√	√	
	Sealed ball bearings, C-3 fit with premium Mobil Polyrex EM grease (-30°C to +150°C)					√
	Open bearings, 364T frame and larger	√				
	Zerk fittings	√		√	√	√
	Extended grease tubes for regreasing without disassembly	√	√	√	√	√
Bearing Caps	Cast iron, 182T and larger	√				√
	Cast iron, 254T and larger			√	√	
	Cast iron, 444T and larger			√	√	
Construction	Rolled steel	√	√	√	√	√
	Cast iron	√	√	√	√	√
Conduit Box	Steel 56-326T, cast iron, 364T and larger, non threaded		√			
	Steel 182T-449T, NPT threaded	√				
	Cast iron, oversized, fully gasketed			√	√	√
Leads	Lead lugs 364T and larger		√	√	√	√
	Permanently marked leads with lead separator			√	√	√
Fan Guard (TEFC)	Steel	√				
	Polypropylene (182T-326T)		√			
	Cast iron (including XRI 364T and larger)		√	√	√	√
Fan (External)	Non-sparking polypropylene (TEFC)	√	√	√	√	√
Drains	Corrosion resistant brass drain and breather	√		√	√	√
	Drilled and tapped hole		√			
Epoxy Finish	Internal and external corrosion resistant epoxy			√	√	√
Hardware	Corrosion resistant zinc dichromate plated hex head hardware		√	√	√	√
	Lifting provisions, 182T and larger	√	√	√	√	√
IP Code	IP43		√			
	IP54			√	√	√
	IP55	√				
	IP56				√	√
Ground	Ground lug provision in conduit box	√	√	√	√	√
	External grounding provision				√	√
Nameplate	Stainless steel - includes NEMA® nominal efficiency and power factor	√	√	√	√	√
	AFBMA bearing identification plate			√	√	√
Seals	V-Ring (Forshed®) seal on drive end	√		√	√	√
	Inpro/Seal® VBX® bearing isolators on drive end of TENV and both ends of TEFC				√	
Slinger	Molded neoprene slinger on shaft end		√	√	√	√
Marine Duty	Meets IEE45 and USCG			√	√	√
	Meets API RP14F for offshore platforms				√	
Division 1 Hazardous Duty	CSA Certification, UL Listed, Class I & II Groups C,D,F,G, Temperature Code T3B					√
Division 2 Hazardous Duty	CSA certification nameplate, Class 1 Groups A, B, C, D, temperature code T2B	√		√	√	
Motor Testing	Actual short commercial test data supplied with each motor		√			
	Actual short commercial test data plus max. vibration test supplied with each motor			√		√
	Actual short commercial test data plus 2 additional vibration tests supplied with each motor				√	
Agency Listings	UL recognized	√	√	√	√	√
	CSA certified	√	√	√	√	√
	CE mark	√	√	√	√	√
Warranty	36 mo. from date of first use, 42 mo. from date of manufacture	√	√	√	√	√
	60 mo. from date of first use, 66 mo. from date of manufacture		√	√	√	√
	Optional extended warranties are available	√	√	√	√	√



Globetrotter®
TEFC & ODP motor



Blue Chip Series® XRI®
TENV & TEFC motor



**Blue Chip Series® XRI®
Severe Duty**
TENV & TEFC motor



**Blue ChipSeries®
XRI® - 841**
I EEE 841 motor



**Blue Chip Series® XRI®
Hazardous Duty**
Division 1, Class I & II
Groups C, D, F & G motor

Mobil and Polyrex are trademarks of Exxon Mobil Corporation and are not controlled by Regal Beloit Corporation.

Inpro/Seal and VBX are believed to be the trademarks or trade names of INPRO/SEAL LLC and are not controlled by Regal Beloit Corporation.

Forshed is believed to be the trademark or trade name of Trelleborg Forshed Sweden AB and is not owned or controlled by Regal Beloit Corporation.

NEMA is a trademark of National Electrical Manufacturers Association. All Rights Reserved.





Regal Beloit America, Inc.

100 East Randolph St., P.O. Box 8003

Wausau, WI 54402-8003

Phone: 715-675-3311

www.RegalBeloit.com

APPLICATION CONSIDERATIONS

The proper selection and application of electric motor and power transmission products and components, including the related area of product safety, is the responsibility of the customer. Operating and performance requirements and potential associated issues will vary appreciably depending upon the use and application of such products and components. The scope of the technical and application information included in this publication is necessarily limited. Unusual operating environments and conditions, lubrication requirements, loading supports, and other factors can materially affect the application and operating results of the products and components and the customer should carefully review its requirements. Any technical advice or review furnished by Regal Beloit America, Inc. and/or its affiliates ("Regal") with respect to the use of products and components is given in good faith and without charge, and Regal assumes no obligation or liability for the advice given, or results obtained, all such advice and review being given and accepted at customer's risk.

For a copy of our Standard Terms and Conditions of Sale, please visit <http://www.regalbeloit.com> (please see link at bottom of page to "Standard Terms and Conditions of Sale"). These terms and conditions of sale, disclaimers and limitations of liability apply to any person who may buy, acquire or use a Regal product referred to herein, including any person who buys from a licensed distributor of these branded products.

Regal, Century, Marathon, Black Max, Blue Chip Series, Blue Max, Globetrotter, Hazardous Duty, Juggernaut, Marathon, Marathon Electric, Max Guard, MicroMAX, Symax, Wash Down Duty, XRI & 4-in-1, are trademarks of Regal Beloit Corporation or one of its affiliated companies.

©1913, 2018 Regal Beloit Corporation, All Rights Reserved. MCC17002E • Form# MB0030E

