

Motors and Drives Price Book



TECO   **Westinghouse**

Effective: 01-01-2022

Quality and Environmental Policy

TECO-Westinghouse Motor Company (TWMC) is committed to serving the needs of our customers BETTER THAN ANYONE ELSE. We strive to provide quality products and services while also minimizing safety and environmental impacts. We are also committed to providing a work environment that protects the health and safety of employees, visitors, and guests. We understand that safety, quality, and environmental stewardship are at the core of our business.

Safety, sustainability, improved efficiency, compliance, and continuity are at the heart of the Quality and Environmental Management Systems. Therefore, management is committed to and personally involved in establishing objectives and periodically reviewing these objectives to ensure its continuing suitability. The management team assures that quality and environmental requirements are clearly stated and implemented. They also provide the necessary training and equipment, establish measurable guidelines, and define priorities for continual improvement.

Quality and environmental objectives and targets are established within the Quality and Environmental Management Systems and are communicated to all employees. TWMC is committed to maintaining these systems, and this cannot be done without each employee striving for excellence in personal job performance. We will not settle for less than exact conformance in anything we do.

TECO-Westinghouse Motor Company (TWMC) está comprometido a satisfacer las necesidades de nuestros clientes MEJOR QUE CUALQUIER OTRA COMPAÑÍA. Nos esforzamos por ofrecer productos y servicios de calidad al mismo tiempo que minimizamos los impactos en la seguridad y el medio ambiente. También estamos comprometidos a proveer un ambiente de trabajo que proteja la salud y seguridad de empleados, visitantes e invitados. Entendemos que la administración de la seguridad, la calidad y el medio ambiente están en el centro de nuestro negocio.

La seguridad, la sostenibilidad, la mejora de la eficiencia, el cumplimiento y la continuidad son el corazón de los Sistemas de Gestión de Calidad y Medio Ambiente. Por lo tanto, la gerencia está comprometida con y personalmente involucrada en el establecimiento de objetivos y revisar periódicamente estos objetivos para asegurar su continuada adecuación. El equipo directivo se asegura que los requisitos de calidad y medioambientales estén claramente establecidos e implementados. También proporcionan la capacitación y el equipo necesarios, establecen pautas medibles y definen las prioridades para la mejora continua.

Se establecen objetivos y metas de calidad y medioambientales dentro de los Sistemas de Gestión de Calidad y Medio Ambiente y se comunican a todos los empleados. TWMC esta comprometido a mantener estos sistemas, y esto no puede hacerse sin que cada empleado se esfuerce por la excelencia en el desempeño de su trabajo personal. No estaremos satisfechos con menos que con la conformidad exacta en cualquier cosa que hagamos.

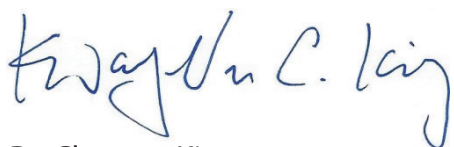

Dr. Clarence King
President, TECO-Westinghouse Motor Company

All data presented in this book is for reference only and subject to change without notice. For specific applications, certified dimensions, or additional performance data, etc., please contact your TECO-Westinghouse representative or call: 1-800-USE-TECO

GENERAL INFORMATION	
ONLINE SUBMITTAL DATA INSTRUCTIONS _____	7
CATALOG NUMBER REFERENCE GUIDE _____	8-9
CONTACT US _____	10
FIELD SERVICE RATES _____	11
STOCK MOTORS SELLING POLICY _____	12-14
TECO-WESTINGHOUSE STOCK MOTOR WARRANTY POLICY _____	15-16
TECO-WESTINGHOUSE STOCK/CONTORL PRODUCT WARRANTY POLICY AND WARRANTY CLAIMS PROCEDURE _____	17
TECO-WESTINGHOUSE DRIVES AND CONTROLS WARRANTY POLICY _____	18
DEFINITE PURPOSE MOTORS	
SINGLE PHASE ODP	
HVAC SINGLE PHASE ODP _____	19
SP/SPH , NEMA PREMIUM (0.25HP - 3HP) [BSGS39] _____	20
SINGLE PHASE TEFC	
HVAC SINGLE PHASE TEFC _____	21
SPT/SPHT , NEMA PREMIUM (1/4 HP - 3 HP) [BEGS39] _____	22
ST , ENERGY EFFICIENT (3 HP - 10 HP) [BEGS19] _____	22
FARM DUTY SINGLE PHASE _____	23
S , HIGH EFFICIENCY (1/3 HP - 1 HP) [BEGCFD] _____	24
S , HIGH EFFICIENCY (1.5 HP) [BECCFD] _____	24
S , HIGH EFFICIENCY (2 HP -10 HP) [BECSFD] _____	24
THREE PHASE ODP	
OIL WELL PUMP MOTOR ODP _____	25
Q , STANDARD EFFICIENCY, DESIGN D (5HP - 125HP) [ASFAFP] _____	26
THREE PHASE TEFC	
OIL WELL PUMP MOTOR TEFC _____	27
QT , STANDARD EFFICIENCY, DESIGN D (5HP - 125HP) [AEEAFP] _____	28
2 SPEED, 1 WINDING, VARIABLE TORQUE _____	29
CP , HIGH EFFICIENCY (100/25HP - 300/75HP) [AECA] _____	30
GENERAL PURPOSE MOTORS	
THREE PHASE ODP	
ROLLED STEEL ODP FAMILY _____	31
DSP , NEMA PREMIUM, F#56 (1/4 HP - 3 HP) [ASGHPE] _____	32
DTP , NEMA PREMIUM, F#140T - 280T (1 HP - 40 HP) [ASGH] FIRE PUMP _____	32
DJPP/DJMP , NEMA PREMIUM, CLOSE COUPLED, (1 HP - 40 HP) [ASGHJP/JM] _____	33
DJPP_FP/DJMP_FP , NEMA PREMIUM, CLOSE COUPLED, (1 HP - 40 HP) [ASGHJP/JM] FIRE PUMP _____	34
ROLLED STEEL ODP AEGIS® SGR _____	35
DTP_G , NEMA PREMIUM WITH AEGIS® SGR (1HP - 40HP) [ASGH] _____	36
CAST IRON ODP _____	37
DHP , NEMA PREMIUM (1HP - 800HP) [ASHH] _____	38-42
DHP_FP , NEMA PREMIUM (1HP - 500HP) [ASHH] FIRE PUMP _____	43-44
CAST IRON ODP AEGIS® SGR _____	45
DHP_G , NEMA PREMIUM WITH AEGIS® SGR [ASHH] _____	46

Notes:

(1) Italicized letters represent the TECO Product Type [e.g. ASHH]. Letters in brackets represent the Catalog Number (e.g. DHP). Both Product Type and Catalog Number can be found on Motor Nameplate.

All data presented in this book is for reference only and subject to change without notice. For specific applications, certified dimensions, or additional performance data, etc., please contact your TECO-Westinghouse representative or call: 1-800-USE-TECO

THREE PHASE TEFC	
THREE PHASE TEFC	
ROLLED STEEL TEFC FAMILY _____	47
GH , NEMA PREMIUM, F#56 (1/4 HP - 2 HP) [AEGHPE] _____	48
GP , NEMA PREMIUM, F#140T - 210T (1 HP - 10 HP) [AEGH] _____	48
GH_C , NEMA PREMIUM, FOOTED C-FACE, F#56 (1/4 HP - 2 HP) [AEGHPE-CF] _____	49
GHV_C , NEMA PREMIUM, ROUND BODY C-FACE, F#56 (1/4 HP - 2 HP) [AETHPE] _____	49
GP_C , NEMA PREMIUM, FOOTED C-FACE, F#140T - 210T (1 HP - 10 HP) [AEGHCF] _____	49
GPV_C , NEMA PREMIUM, ROUND BODY C-FACE, F#140T - 210T (1 HP - 10 HP) [AETHCF] _____	49
ROLLED STEEL TEFC AEGIS® SGR _____	50
GP_G , FOOTED, NEMA PREMIUM WITH AEGIS® SGR (1HP - 10HP) [AEGH] _____	51
MAX-IE3™ METRIC _____	52
MP , IEC, IE3 EFFICIENCY (1HP - 150HP) [AESV3W] _____	53
MAX-PM™ PERMANENT MAGNET _____	54
PM , PERMANENT MAGNET SYNCHRONOUS MOTOR, TEFC (1HP - 30HP) [DVEM] _____	55-56
THREE PHASE TEFC - SEVERE DUTY MOTORS	
CAST IRON TEFC JP/JM _____	57
JPP/JMP , NEMA PREMIUM, CLOSE-COUPLED (1 HP - 50 HP) [AEHH8NJ/JM] _____	58
MAX-PE™ FAMILY - PREMIUM SEVERE DUTY MOTOR _____	59
NP , NEMA PREMIUM (1 HP - 200 HP) [AEHH8P] _____	60-61
NP_C , NEMA PREMIUM, FOOTED C-FACE (1 HP - 200 HP) [AEHH8PCF] _____	62
NPV_C , NEMA PREMIUM, ROUND BODY C-FACE (1 HP - 200 HP) [AEUH8PDC] _____	62
MAX-PE™ AEGIS® SGR _____	63
NP_G , NEMA PREMIUM WITH AEGIS® SGR (1 HP - 75 HP) [AEHH8P] _____	64
MAX-E1® FAMILY - ALL CAST PREMIUM SEVERE DUTY MOTOR _____	65
EP , NEMA PREMIUM (1 HP - 400 HP) [AEHH8N] _____	66-72
EP_C , NEMA PREMIUM, FOOTED C-FACE (1 HP - 300 HP) [AEHH8NCF] _____	73
EPV_C , NEMA PREMIUM, ROUND BODY C-FACE (1 HP - 300 HP) [AEUH8NDC] _____	73
MAX-E1® VERTICAL ROUND BODY SOLID SHAFT, NORMAL/MEDIUM THRUST with "P" BASE-LOW VOLTAGE _____	74
EPV_P , NEMA PREMIUM, ROUND BODY (25 HP - 200HP) [AEUH8NDP] _____	75
MAX-E1® FAMILY - ALL CAST PREMIUM SEVERE DUTY MOTOR, F1, F2, AND F3 FIELD CONVERTABLE _____	76
EPF , NEMA PREMIUM EFFICIENCY (200 HP - 2000 HP) [AFHH] _____	77-78
KEYLESS SHAFT MOTOR _____	79
EPY , NEMA PREMIUM (200 HP - 500 HP) [AEHHSY] _____	80
EY , HIGH EFFICIENCY (600 HP - 800HP) [AEHESY] _____	81
MAX-E2/841® "LITE" - IEEE-841 READY MOTOR _____	82
HH , NEMA PREMIUM (1 HP - 300 HP) [AEHH] _____	83
MAX-E2/841® FAMILY - IEEE-841 MOTOR _____	84
HB , NEMA PREMIUM (1 HP - 500 HP) [AEHH8B] _____	85-86
HB_C , NEMA PREMIUM, FOOTED C-FACE (1 HP - 100 HP) [AEHH8BCF] _____	87
HBV_C , NEMA PREMIUM, ROUND BODY C-FACE (1 HP - 100 HP) [AEUH8BDC] _____	87
MAX-E2/841® VERTICAL ROUND BODY SOLID SHAFT, HIGH THRUST with "P" BASE-LOW VOLTAGE _____	88
HBV_P , NEMA PREMIUM, ROUND BODY, IEEE-841 MOTOR (7.5 HP - 100HP) [AEUH8BDP] _____	89
MAX-HT™ LOW VOLTAGE CRUSHER DUTY MOTOR _____	90
CDP , NEMA PREMIUM, DESIGN C (20 HP - 200 HP) [AEHHGD] _____	91
CDP , NEMA PREMIUM, DESIGN A (200 HP - 500 HP) [AEHHGD] _____	92
MAX-HT™ LOW VOLTAGE DESIGN CRUSHER DUTY MOTOR _____	93
CD , EPACT DESIGN C (300 HP - 600 HP) [AEEAGD] _____	94

Notes:

- (1) Italicized letters represent the TECO Product Type [e.g. ASHH]. Letters in brackets represent the Catalog Number (e.g. DHP). Both Product Type and Catalog Number can be found on Motor Nameplate.
- (2) Medium Voltage Crusher Duty Motor (pg. 95-96) and Medium Voltage Vertical Motors offered (various - see next page for details).

All data presented in this book is for reference only and subject to change without notice. For specific applications, certified dimensions, or additional performance data, etc., please contact your TECO-Westinghouse representative or call: 1-800-USE-TECO

MAX-HT™ MEDIUM VOLTAGE CRUSHER DUTY MOTOR _____	95
KD , ENERGY EFFICIENT, HIGH TORQUE (100 HP - 900 HP) [AEHAGD] _____	96
WASHDOWN MOTOR _____	97
WFP/WP , NEMA PREMIUM, FOOTED C-FACE (0.5 HP - 10 HP) [AEGP] _____	98
WFPV/WPV , NEMA PREMIUM, TEFC, ROUND BODY C-FACE (0.5 HP - 10 HP) [AEGPCW] _____	98
WFR/WR , NEMA PREMIUM, TEFC, FOOTED C-FACE, F1 (0.5 HP - 10 HP) [AEGPQL] _____	99
WFN/WN , NEMA PREMIUM, TENV, FOOTED C-FACE, F1 (0.5 HP - 3 HP) [AEGNQL] _____	100
WFNV/WNV , NEMA PREMIUM, TENV, ROUND BODY C-FACE (0.5 HP - 3 HP) [AETNQL] _____	100
EXPLOSION PROOF MOTORS	
TEXP FAMILY _____	101
XP , NEMA PREMIUM (1 HP - 400 HP) [AEHHXV/AEHHXU] _____	102-103
XP_C , NEMA PREMIUM, FOOTED C-FACE (1 HP - 100 HP)[AEHHXG/AEHHXF] _____	104
XPV_C , NEMA PREMIUM, ROUND BODY C-FACE (1 HP - 75 HP)[AEUHXG/AEUHXF] _____	105
MEDIUM VOLTAGE MOTORS - GLOBAL SERIES	
GLOBAL MAX WPI _____	105
PG , NEMA PREMIUM, MEDIUM VOLTAGE (100 HP - 2000 HP) [AMHGTK] _____	106
GLOBAL WPI _____	107
P , HIGH EFFICIENCY, MEDIUM VOLTAGE [ASHA] _____	108
GLOBAL XPE _____	109
KG , TEFC, NEMA PREMIUM, MEDIUM VOLTAGE (100 HP - 900 HP)[AEHGTK] _____	110
GLOBAL MAX _____	111
KF , NEMA PREMIUM, MEDIUM VOLTAGE (500 HP - 2000 HP)[AFGHTK] _____	112
JF , IEC, HIGH EFFICIENCY, MEDIUM VOLTAGE (900 HP - 1750 HP)[AFJHTK] _____	113
MV MAX-E2™/841 LITE _____	114
KPF , TEFC, NEMA PREMIUM, MEDIUM VOLTAGE, MV MAX-E2/841 LITE (200 HP - 2000 HP)[AFHP] _____	115-117
VERTICAL MOTORS	
VERTICAL HOLLOW SHAFT MOTORS	
WPI LOW VOLTAGE HIGH THRUST WITH "P" BASE _____	118
VHP , (MAX-VHP™) NEMA PREMIUM (7.5 HP - 800 HP) [AMRCNH] _____	119
VHP_FP , (MAX-VHP™) HIGH EFFICIENCY (7.5 HP - 400 HP) [AMRCNH]* FIRE PUMP _____	120
VH_FP , (MAX-VH™) HIGH EFFICIENCY (7.5 HP - 400 HP) [AMRCFP]* FIRE PUMP _____	121
TEFC LOW VOLTAGE HIGH THRUST WITH "P" BASE _____	122
VHTP , (MAX-VHP™) NEMA PREMIUM (15 HP - 800 HP)[AEEHNNH] _____	123
WPI MEDIUM VOLTAGE HIGH THRUST WITH "P" BASE _____	124
VHKP , NEMA PREMIUM (200 HP - 1000 HP) [AMRKNH] _____	125
TEFC MEDIUM VOLTAGE HIGH THRUST WITH "P" BASE _____	126
VHKTP , NEMA PREMIUM (150 HP - 700 HP) [AEHCNH] _____	127
VERTICAL HOLLOW SHAFT WPI COUPLING KITS _____	128
VERTICAL HOLLOW SHAFT TEFC COUPLING KITS _____	129
VERTICAL HOLLOW SHAFT WPI STEADY BUSHING KITS _____	130
VERTICAL HOLLOW SHAFT TEFC STEADY BUSHING KITS _____	131

Notes:

* Fire Pump Available.

(1) Italicized letters represent the TECO Product Type [e.g. ASHH]. Letters in brackets represent the Catalog Number (e.g. DHP). Both Product Type and Catalog Number can be found on Motor Nameplate.

All data presented in this book is for reference only and subject to change without notice. For specific applications, certified dimensions, or additional performance data, etc., please contact your TECO-Westinghouse representative or call: 1-800-USE-TECO

VERTICAL SOLID SHAFT MOTORS	
WPI LOW VOLTAGE HIGH THRUST WITH "P" BASE _____	132
VSP (MAX-VSP™) NEMA PREMIUM (15 HP - 800 HP) [AMRCED] FIRE PUMP _____	133
VSP_FP (MAX-VSP™) NEMA PREMIUM (15 HP - 400 HP) [AMRCED] FIRE PUMP _____	134
TEFC LOW VOLTAGE HIGH THRUST WITH "P" BASE _____	135
VSTP (MAX-VSPTM) NEMA PREMIUM (15 HP - 800 HP) [AEEHED] _____	136
WPI MEDIUM VOLTAGE HIGH THRUST WITH "P" BASE _____	137
VSKP , NEMA PREMIUM 200 HP - 1000 HP) [AMRKED] _____	138
TEFC MEDIUM VOLTAGE HIGH THRUST WITH "P" BASE _____	139
VSKTP , NEMA PREMIUM (150 HP - 700 HP) [AEHCED] _____	140
KITS	
C-FLANGE KITS _____	141-142
D-FLANGE KITS _____	143
DRIP COVERS AND PAINT _____	144
P-BASES _____	145-146
FACTORY MODIFICATIONS	
FACTORY MODIFICATION PRICING _____	147-148
FACTORY MODIFICATION DESCRIPTIONS _____	149-151
MODIFICATION DRAWING REQUIREMENTS _____	152
DIMENSIONS AC MACHINES _____	153-154
CUSTOM ENGINEERED LARGE MOTORS	
WORLD SERIES® MOTORS _____	155-157
WORLD SERIES® AIR CABINET DESIGN LIST _____	158
SYNCHRONOUS MOTORS _____	159
DC MOTORS _____	160
SERVICE	
LARGE MOTOR REPAIR _____	161
RENEWAL PARTS AND ENGINEERED COMPONENTS _____	162
ENGINEERING SERVICES _____	162
SYNCHRONOUS CONTROL SYSTEMS _____	163-164
PREDICTIVE MAINTENANCE _____	165
MOTOR HEALTH MANAGEMENT (VB-100 SMART VIBRATION METER) _____	166
REFERENCE	
USEFUL FORMULAS _____	167

Notes:

- (1) Italicized letters represent the TECO Product Type [e.g. ASHH]. Letters in brackets represent the Catalog Number (e.g. DHP). Both Product Type and Catalog Number can be found on Motor Nameplate.

AC DRIVES	
AC DRIVE PACKAGING CAPABILITIES _____	169
MOTOR AND DRIVE COMBINATION PACKAGES _____	170
APPLICATION GUIDELINES FOR PACKAGED COMBO MOTOR/VFD'S _____	171-173
L510 MICRO DRIVE FEATURES (0.25 HP - 3 HP) _____	174
L510 MICRO DRIVE (0.25 HP - 3 HP) _____	175
L510 BRAKE RESISTORS & OPTIONS _____	176
E510 COMPACT (.5 HP - 75 HP) _____	177
E510 NEMA 1 (.5 HP - 75 HP) _____	178
E510 NEMA 1 PERI & BRAKINGS UNIT _____	179
E510 NEMA 4, 4X/12 INDOOR USE ONLY (.5 HP - 25 HP) _____	180
E510 NEMA 4, 4X/12 WITH DISCONNECT SWITCH INDOOR USE ONLY _____	181
E510 NEMA 4, 4X/12 4 PERIPHERALS _____	182
E510 NEMA 4 BRAKE RESISTOR & MOD _____	183
A510 HEAVY DUTY (1 HP - 270 HP) _____	184
A510 HEAVY DUTY DRIVE _____	185-186
A510 PERIPHERALS _____	187
A510 BRAKE RESISTORS & MODS _____	188-189
BRAKE MODULES AND RESISTORS	
F510 FAN & PUMP DUTY (5 HP - 250 HP) _____	190
F510 FAN & PUMP _____	191
F510 PERIPHERALS _____	192
F510 BRAKE RESISTORS & MODS _____	193-194
EQ7 AC DRIVE (1 HP - 1000 HP) _____	195
EQ7 MULTIPLE DUTY _____	196
EQ7 PERIPHERALS _____	197
LINE REACTORS	
LINE REACTORS 3%, 5% IMPEDANCE 230V (1 HP - 150 HP) _____	198
LINE REACTORS 3%, 5% IMPEDANCE 460V (1 HP - 800 HP) _____	199
OUTPUT REACTORS/ LOW PASS FILTER COMBINATION 460V (1 HP - 600 HP) _____	200
SOLID STATE STARTERS	
TEAMMASTER™ LOW VOLTAGE (15 HP - 1200 HP) _____	201
TEAMMASTER™ CHASSIS _____	202
TEAMMASTER™ LV _____	203
TEAMMASTER™ MEDIUM VOLTAGE (650 HP - 3000 HP) _____	204
TEAMMASTER™ MV _____	205
MEDIUM VOLTAGE DRIVES	
VERSABRIDGE® _____	206-208
ADDITIONAL DRIVE INFORMATION	
CONTROLS RMA RETURN PROCEDURE _____	209
ABBREVIATED APPLICATION CHECKLIST _____	210-211
ENCLOSURE OPTIONS AND MODIFICATIONS _____	212
NEMA ENCLOSURE RATING DESCRIPTIONS _____	213

ONLINE SUBMITTAL DATA INSTRUCTIONS

ONLINE INSTRUCTIONS

SUBMITTAL DATA

Submittal data consists of basic performance data, dimensional drawings, connection diagrams, and instruction manuals. Mechanical and electrical submittal data is available on many stock catalog motors through our website www.tecowestinghouse.com by following three easy steps. If additional submittal data is required, please contact your TECO-Westinghouse representative.

1. From our website homepage, www.tecowestinghouse.com, scroll to the bottom, enter in the part or catalog number in the box labeled "Find" and then click on "Go".

(Note: If you have a TECO-Westinghouse motor and are looking for the performance data, please use the catalog number from the nameplate for your search. Ex: EP0102.)

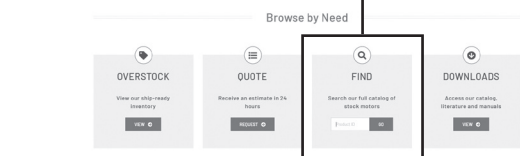
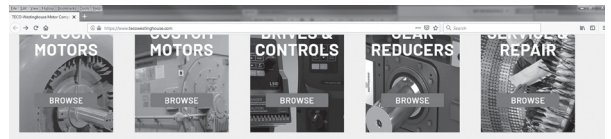
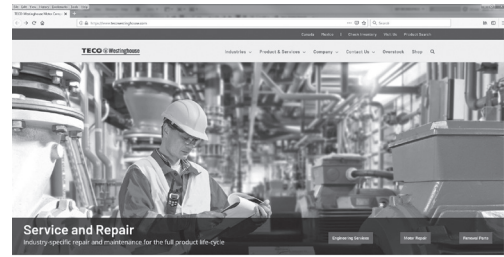

2. A product listing page will appear about the motor. You will be able to print the available performance data, dimensional drawings, connection diagrams, and instruction manuals in PDF format for the motor you have selected. Links to the available information are listed at the bottom of the screen. **Click on the appropriate product link for the information that you need.**



3. Your results will look similar to the example shown to the left for the TWMC MAX-E1 NEMA Premium Efficiency Severe Duty TEFC motor, Catalog# EP0102.

It's that easy!

TECO Westinghouse											
REVISED:	PERFORMANCE DATA										ENCLOSURE
5/5/2008	3-PHASE INDUCTION MOTOR										TEFC
TYPE:	AEHHN										CATALOG#
											EP0102
NAMEPLATE INFORMATION											
COUNTRY OF ORIGIN	FRAME	BASED	INS.	NEMA	TEMP	SERVICE					
USA	215T	230/460	60	40	10	SEVERE					
SIZE	VOLTS	HP	AMP	CLASS	DESIGN	RATING	FACTORS				
2	215T	10	40	1	1	B	CONC				
VARIABLE FREQUENCY DRIVE SERVICE											
VARIABLE TORQUE											
CONSTANT TORQUE											
CONSTANT HORSEPOWER											
EFFICIENCY											
TYPICAL PERFORMANCE											
POWERFACTOR											
CORRECTIONS											
LOCKED ROTOR											
SAFE STALL											
TORQUE											
INERTIA											
ACCEL TIME (S)											
ALLOWABLE											
STRESS PER HOUR											
APPROVED:											
DRAWING NO:											
31057EP0102											
REVISION:											
0											

CATALOG NUMBER REFERENCE GUIDE

Effective: 01-01-2022
Supersedes: 07-06-2021

EXAMPLE:

DHP 075 4 R

FIRST 1 TO 3 SPACES (LETTERS) DESIGNATE THE MOTOR CATALOG TYPE

THREE PHASE ODP

DSP=	ROLLED STEEL ODP NEMA PREMIUM F#56 (1/4 HP - 3 HP)
DTP=	ROLLED STEEL ODP NEMA PREMIUM F#140T - 280T (1 HP - 40 HP)
DJPP/DJMP=	ROLLED STEEL ODP JP/JM NEMA PREMIUM (1 HP - 40 HP)
DJPP_FP/DJMP_FP=	ROLLED STEEL ODP JP/JM NEMA PREMIUM FIRE PUMP (1 HP - 40 HP)
DTP_G=	ROLLED STEEL ODP NEMA PREMIUM WITH AEGIS® SGR (1 HP - 40 HP)
DHP=	CAST IRON ODP NEMA PREMIUM (1 HP - 800 HP)
DHP_FP=	CAST IRON ODP NEMA PREMIUM FIRE PUMP (1 HP - 75 HP)
DHP_G=	CAST IRON ODP NEMA PREMIUM WITH AEGIS® SGR (1 HP - 75 HP)

THREE PHASE TEFC - GENERAL PURPOSE MOTORS

GH=	ROLLED STEEL TEFC NEMA PREMIUM F#56 (1/4 HP - 2 HP)
GP=	ROLLED STEEL TEFC NEMA PREMIUM F#140T - 210T (1 HP - 10 HP)
GH_C=	ROLLED STEEL TEFC NEMA PREMIUM FOOTED C-FACE F#56 (1/4 HP - 2 HP)
GHV_C=	ROLLED STEEL TEFC NEMA PREMIUM ROUND BODY C-FACE F#56 (1/4 HP - 2 HP)
GP_C=	ROLLED STEEL TEFC NEMA PREMIUM FOOTED C-FACE F#140T - 210T (1 HP - 10 HP)
GPV_C=	ROLLED STEEL TEFC NEMA PREMIUM ROUND BODY C-FACE F#140T - 210T (1 HP - 10 HP)
GP_G=	ROLLED STEEL TEFC NEMA PREMIUM WITH AEGIS® SGR (1 HP - 10 HP)
MP=	MAX-IE3 METRIC PREMIUM IE3 EFFICIENCY (0.75 Kw - 112 kW)

THREE PHASE TEFC - SEVERE DUTY MOTORS

JPP/JMP=	CAST IRON TEFC JP/JM NEMA PREMIUM (1 HP - 50 HP)
NP=	MAX-PE™ NEMA PREMIUM (1 HP - 200 HP)
NP_C=	MAX-PE™ NEMA PREMIUM FOOTED C-FACE (1 HP - 200 HP)
NPV_C=	MAX-PE™ NEMA PREMIUM ROUND BODY C-FACE (1 HP - 200 HP)
NP_G=	MAX-PE™ NEMA PREMIUM WITH AEGIS® SGR (1 HP - 75 HP)
*NV_C=	MAX-SE™ HIGH EFFICIENCY ROUND BODY C-FACE (1 HP - 100 HP)
EP=	MAX-E1® HIGH EFFICIENCY (3/4 HP - 400 HP)
EPF=	MAX-E1® NEMA PREMIUM F3 CONVERTABLE (200 HP - 1000 HP)
EP_C=	MAX-E1® NEMA PREMIUM FOOTED C-FACE (1 HP - 300 HP)
EPV_C=	MAX-E1® NEMA PREMIUM ROUND BODY C-FACE (1 HP - 300 HP)
EPY=	KEYLESS SHAFT NEMA PREMIUM (200 HP - 500 HP)
EY=	KEYLESS SHAFT HIGH EFFICIENCY (600 HP - 800 HP)
HH=	MAX-E2/841° "LITE" NEMA PREMIUM (1 HP - 300 HP)
HB=	MAX-E2/841° NEMA PREMIUM (1 HP - 500 HP)
HB_C=	MAX-E2/841° NEMA PREMIUM FOOTED C-FACE (1 HP - 100 HP)
HBV_C=	MAX-E2/841° NEMA PREMIUM ROUND BODY C-FACE (1 HP - 100 HP)
CDP=	MAX-HT™ NEMA PREMIUM DESIGN C (20 HP - 200 HP)
CDP=	MAX-HT™ NEMA PREMIUM DESIGN A (250 HP - 500 HP)
*CD=	MAX-HT™ HIGH EFFICIENCY DESIGN C (20 HP - 600 HP)
KD=	MAX-HT™ MEDIUM VOLTAGE ENERGY EFFICIENT HIGH TORQUE (100 HP - 900 HP)
MP=	MAX-IE3 METRIC PREMIUM IE3 EFFICIENCY (0.75 Kw - 112 kW)

THREE PHASE TEFC - SEVERE DUTY MOTORS

PM=	MAX-PM™ PERMANENT MAGNET SYNCHRONOUS MOTOR, A/C, TEFC (1 HP - 30 HP)
-----	--

DEFINITE PURPOSE MOTORS

WFP/WP=	STAINLESS STEEL WASHDOWN NEMA PREMIUM TEFC F3 FOOTED C-FACE (1/2 HP - 10 HP)
WFPV/WPV=	STAINLESS STEEL WASHDOWN NEMA PREMIUM TEFC ROUND BODY C-FACE (1/2 HP - 10 HP)
WFR/WR=	STAINLESS STEEL WASHDOWN NEMA PREMIUM TEFC F1 FOOTED C-FACE (1/2 HP - 10 HP)
WFNV/WN=	STAINLESS STEEL WASHDOWN NEMA PREMIUM TENV F1 FOOTED C-FACE (1/2 HP - 3 HP)
WFNV/WNV=	STAINLESS STEEL WASHDOWN NEMA PREMIUM TENV ROUND BODY C-FACE (1/2 HP - 3 HP)
SP/SPH=	HVAC SINGLE PHASE OPD (1/4 HP - 3 HP)
ST/SPT/SPHT=	HVAC SINGLE PHASE TEFC (1/4 HP - 10 HP)
S=	FARM DUTY SINGLE PHASE HIGH TORQUE (1/3 HP - 10 HP)
S_C=	FARM DUTY SINGLE PHASE HIGH TORQUE (1/3 HP - 10 HP)
Q=	ODP OIL WELL PUMP STANDARD EFFICIENCY (5 HP - 125 HP)
QT=	TEFC OIL WELL PUMP STANDARD EFFICIENCY (5 HP - 125 HP)
CP=	2 SPEED, 1 WINDING, VARIABLE TORQUE HIGH EFFICIENCY (100/25 HP - 300/75 HP)

CATALOG NUMBER REFERENCE GUIDE

Effective: 01-01-2022
Supersedes: 07-06-2021

EXAMPLE:

DHP 075 4 R

FIRST 1-3 SPACES (LETTERS) DESIGNATE THE MOTOR PRODUCT LINE

EXPLOSION PROOF MOTORS

XP=	TEXP EXPLOSION PROOF NEMA PREMIUM (1 HP - 400 HP)
XP_C=	TEXP EXPLOSION PROOF NEMA PREMIUM FOOTED C-FACE (1 HP - 100 HP)
XPV_C=	TEXP EXPLOSION PROOF NEMA PREMIUM ROUND BODY C-FACE (1 HP - 75 HP)

MEDIUM VOLTAGE MOTORS - GLOBAL SERIES

PG=	MEDIUM VOLTAGE WPI NEMA PREMIUM (100 HP - 2000 HP)
P=	MEDIUM VOLTAGE ODP HIGH EFFICIENCY (100 HP - 1000 HP)
KG=	MEDIUM VOLTAGE TEFC NEMA PREMIUM (100 HP - 900 HP)
JF=	MEDIUM VOLTAGE TEFC IEC HIGH EFFICIENCY - 2 POLE ONLY (900 HP - 1750 HP)
KPF=	MEDIUM VOLTAGE TEFC NEMA PREMIUM EFFICIENCY MV MAX-E2/841 LITE (200 HP - 2000 HP)

VERTICAL MOTORS

VHP_FP=	MAX-VHP™ LV HT VHS WPI NEMA PREMIUM FIRE PUMP (7.5 HP - 800 HP)
VHP=	MAX-VHP™ LV HT VHS WPI NEMA PREMIUM (7.5 HP - 800 HP)
VH_FP=	MAX-VH™ LV HT VHS WPI HIGH EFFICIENCY FIRE PUMP (7.5 HP - 400 HP)
VHTP=	MAX-VHP™ LV HT VHS TEFC NEMA PREMIUM (15 HP - 800 HP)
VHKP=	MEDIUM VOLTAGE HT WPI NEMA PREMIUM (200 HP - 1000 HP)
VHKTP=	MEDIUM VOLTAGE HT TEFC NEMA PREMIUM (200 HP - 700 HP)
EPV_P=	MAX-E1™ LV NORMAL THRUST VSS ROUND BODY NEMA PREMIUM (7.5 HP - 100 HP)
HBV_P=	MAX-E2/841™ LV NORMAL THRUST VSS ROUND BODY NEMA PREMIUM (15 HP - 100 HP)
VSP=	MAX-VSP™ LV HT VSS WPI NEMA PREMIUM (15 HP - 800 HP)
VSP_FP=	MAX-VSP™ LV HT VSS WPI NEMA PREMIUM FIRE PUMP (15 HP - 400 HP)
VSTP=	MAX-VSP™ LV HT VSS TEFC NEMA PREMIUM (15 HP - 800 HP)
VSKP=	LOW VOLTAGE HT VSS WPI PREMIUM EFFICIENCY (200 HP - 1000 HP)
VSKTP=	MEDIUM VOLTAGE HT VSS TEFC PREMIUM EFFICIENCY (200 HP - 700 HP)

NEXT 3 TO 4 SPACES (NUMBERS) DESIGNATE THE MOTOR HP

THE FOLLOWING MOTOR LINES ARE THE ONLY ONES THAT WILL HAVE 4 SPACES: PG, P, KF, JF, KPF, EPF, VHKP, VSKP

FOR ALL OTHERS, IF HP IS <100, USE A "0" IN 1ST SPACE -- "025" = 25 HP (i.g. EP0254)

IF HP IS <100, USE A "0" IN THE 1ST SPACE - "075" = 75 HP

IF HP < 1, USE A "0" IN THE 1ST SPACE, FOLLOWED BY A "/", THEN THE NUMBER AFTER THE DECIMAL - "0/2" = 0.25 HP (i.g. DSP0/22)

IF HP HAS A DECIMAL > 1, USE THE WHOLE NUMBER 1ST FOLLOWED BY A "/", THEN THE NUMBER AFTER THE DECIMAL - "7/5" = 7.5 HP (e.g. DTP7/54)

NEXT SPACE (NUMBER) DESIGNATES THE SPEED

2	=	2 POLE	=	3600 OR 3000 RPM
4	=	4 POLE	=	1800 OR 1500 RPM
6	=	6 POLE	=	1200 OR 1000 RPM
8	=	8 POLE	=	900 OR 750 RPM

NEXT SPACE IF OCCUPIED

S	=	4 POLE MOTOR WITH SHORT SHAFT (TS)
5	=	MOTOR STOCKED STANDARD AS 575 VOLT
R	=	MOTOR STOCKED STANDARD WITH A DRIVE-END ROLLER BEARING
C	=	MOTOR STOCKED STANDARD WITH A C-FACE
T	=	MOTOR STOCKED STANDARD WITH NEMA SHAFT "T" (STANDARD SHAFT)
TZ	=	MOTOR STOCKED STANDARD WITH SPECIAL SHAFT "TZ" (CUSTOM SHAFT)
TR	=	MOTOR STOCKED STANDARD WITH SPECIAL NON-NEMA SHAFT
X	=	HYBRID FRAME MEETING ALL THE REQUIRED NEMA DIMENSIONS, THE X WILL BE PLACED AT THE END OF THE FRAME SIZE. EX: 324T(X)

Notes:

1. Vertical motor abbreviations: "VHS" stands for "Vertical Hollow Shaft", "VSS" stands for "Vertical Solid Shaft", "LV" stands for "Low Voltage", "HT" stands for "High Thrust".
2. "ODP" stands for "Open Drip Proof".
3. "WPI" stands for "Weather Protected Type I".

CONTACT US

Effective: 01-01-2022
Supersedes: 07-06-2021



TECO-Westinghouse Motor Company Headquarters

5100 North IH-35
Round Rock, Texas 78681



STOCK MOTOR GROUP		Customer Service Hours: 7:00 am to 7:00 pm CST, Monday through Friday Toll Free: 1-800-USE-TECO (873-8326)
T-Frame Documents:	tframedocs@tecowestinghouse.com	Drawings, Test Reports, Submittal Requests, Etc.
T-Frame Parts:	tframeparts@tecowestinghouse.com	Stock Parts Quotes and Availability
T-Frame Warranty:	tframewarranty@tecowestinghouse.com	Warranty Support
Customer Service:	customerservice@tecowestinghouse.com	Orders Status, Stock Checks, Quotes, Etc.
Purchase Orders Entry:	orders@tecowestinghouse.com	Stock Orders Only
CONTROLS GROUP		Toll Free: 1-800-279-4007
Low Voltage Tech Support	controlstechsupport@tecowestinghouse.com	Technical Support,
Low Voltage Warranty	controls_warranty@tecowestinghouse.com	Controls Warranty Support
Purchase Orders Entry	orders@tecowestinghouse.com	Orders Only
CENTRAL PHONE NUMBERS		
Stock Product Group Customer Service		1-800-873-8326
Controls Group Customer Service		1-800-279-4007

After Hours Emergency Lines: 24 Hours a Day / 7 Days a Week	
Sales/ Customer Service*:	512-632-7338
Motor Technical Support:	512-538-8771
Control Technical Support:	512-633-1513

Customer Service Center Locations:
• Spartanburg, South Carolina
• Round Rock, Texas

Warehouse Distribution Center Locations:
• Spartanburg, South Carolina
• Allentown, Pennsylvania
• Des Moines, Iowa
• Round Rock, Texas
• Reno/Sparks, Nevada
• Chicago, Illinois

Notes:
* Additional fees apply for after hours emergency sales.
For additional details, please contact your Customer Service Representative or Outside Sales Representative for your area.

TECO-WESTINGHOUSE MOTOR COMPANY FIELD SERVICE RATES

Effective: 01-01-2022
Supercedes: 07-06-2021



FIELD SERVICE

Domestic Field Service Rate **\$ 180.00 / hr***

International Field Service Rate **\$ 200.00 / hr***

EXPENSES

Travel Time Charged as above*

Mileage **\$ 0.75 / mile***

Meals (Domestic) **\$ 55.00 / day**

Meals (International) **\$ 75.00 / day**

Expenses (Gross Margin) **Cost plus 30%**

(Includes subcontractors, materials, freight, lodging and transportation)

NOTES

1. The rates are valid through December 31, 2021.
2. Normal field service working hours are 7:00 A.M. until 4:00 P.M., Monday - Friday.
3. Saturdays and after eight consecutive hours worked or traveled will be billed at normal rate x 1.5
4. Sundays and after twelve consecutive hours worked or traveled will be billed at normal rate x 2.0
5. Holidays will be billed at normal rate x 3.0
6. Stand-by time will be billed as described above when personnel are unable to work due to circumstances beyond TWMC control.
7. For services rendered at isolated locations or where service personnel must remain at the job site on a twenty-hour basis, the rate will be commensurate with the conditions of the facility.
8. When service personnel are required to perform work in locations that are judged by TWMC to be high risk areas, a hazard rate will be applied.
9. Mileage will be billed when technicians use their personal vehicles in lieu of airfare or a rental car.
10. Rates do not include local, state, federal, international taxes, duties, or tariffs.

Rev. 11, 10/06/2020



5100 N. IH-35, Round Rock, TX 78681

Toll-Free: 1-800-451-8798 . Phone: 512-255-4141 . Fax: 512-244-5512

www.tecowestinghouse.com

STOCK MOTOR SELLING POLICY

Effective: 01-01-2022
Supersedes: 07-06-2021

Terms and Conditions of Sale

TECO-Westinghouse Motor Company (TWMC) hereby gives notice of its objection to any different or additional terms and conditions. Unless different or additional terms are stated in TWMC's proposal, in which event:

- 1) Such different or additional terms shall be exclusive as to the subject covered,
- 2) The terms and conditions stated herein apply, and
- 3) Such Terms and Conditions supersede any prior or contemporaneous agreements or correspondence between the parties.

This sale is expressly conditional on the Purchaser's assent to the Terms and Conditions stated herein. The Purchaser's direction to proceed with any of the engineering, manufacture, or shipment of any product is conclusive as to such assent.

Dispatch of the Purchaser's purchase order (PO) will constitute an acceptance of the quotation, and an assent to the Terms and Conditions stated herein, if the purchase order agrees with the quotation in respect to all material terms.

Quotations

Each quotation is valid for thirty (30) days from the date of the quotation unless otherwise stated in the quotation.

Minimum Billing

The minimum billing per order shall be \$100.00, unless otherwise agreed upon by TWMC.

Taxes

With the exception of Harbor Maintenance Tax as stated in the following paragraph, TWMC will assume the payment of all taxes and fees assessed by any taxing authority in the United States with respect to this order. The Purchaser will assume the payment of all taxes, duties, fees and other charges assessed by any taxing authority in the Purchaser's country or country of ultimate destination with respect to this order.

Under FAS Incoterms it is the Purchaser's responsibility to clear the goods for export. Accordingly, should the Purchaser appoint a freight forwarder or agent to effect export on the Purchaser's instruction, the Purchaser's freight forwarder is responsible for payment of the US Harbor Maintenance Tax on behalf of the Purchaser.

Terms of Payment

A. Net 30

For contracts with a total price less than \$250,000 and with a shipment date less than twelve (12) months from the date of order, an invoice will be issued when each unit is shipped and the standard terms of payment are net within thirty (30) days from the date of invoice.

B. Progress Payments

For contracts with a total price greater than \$250,000 and/or with a shipment date greater than 12 months from the date of order, the following payment terms shall apply:

1. 10% of the contract price shall be invoiced when drawings for approval are issued by TWMC. If drawings for approval are not specified, an invoice will be mailed when construction drawings are issued, but in no event later than 120 days after the date of order.
2. 30% of the price of each unit shall be invoiced seven (7) months prior to the first day of the scheduled shipment month of that unit.
3. 30% of the price of each unit shall be invoiced four (4) months prior to the first day of the scheduled shipment month of that unit.
4. The final 30% of the price of each unit shall be invoiced upon complete shipment of each unit.

In each of the above instances, the terms of payment are net within 30 days from date of invoice.

5. A separate invoice will be issued concurrently with sections 1, 2, 3, and

4 for the escalation on that portion of the contract price. The escalation for the portion of the contract involved under 1, 2, 3, and 4 ceases on the date the invoice is issued.

C. Adequate Assurances of Payment

If, in the judgment of TWMC, the financial condition of the Purchaser does not justify the terms of payment specified, TWMC may, at its option, require full or partial payment in advance.

Overdue Payments

If payments are not made in accordance with these terms, the quoted price shall, without prejudice to the right of TWMC to immediate payment, be increased by an amount equal to the lesser of 1.5 percent (%), or the highest legal rate of interest on the unpaid balance, plus all expenses of collection including but not limited to attorneys' fees and court costs.

Delivery

Delivery of each item of equipment shall be made FOB Point of Shipment with freight prepaid. Purchaser shall reimburse TWMC for freight charges in an amount equal to the lesser of TWMC's NEMA Frame Freight Policy in effect at the time of shipment or actual freight charges. Such amounts will be paid by the Purchaser upon presentation of invoice by TWMC.

Force Majeure

TWMC shall not be liable for failure to perform or for delay in performance resulting from any cause beyond TWMC's reasonable control or due to compliance with any regulations, orders, acts, instructions or priority requests of any federal, state, or municipal Government, or any department or agency thereof, civil or military authority, acts of God, acts or omissions of the Purchaser, fires, floods, weather, strikes, lockouts, factory shutdowns, faulty castings or forgings, embargoes, wars, hostilities, riots, delays or shortages in transportation or

STOCK MOTOR SELLING POLICY

Effective: 01-01-2022
Supersedes: 07-06-2021

inability to obtain labor, manufacturing facilities, or material from TWMC's usual sources. In the event of delay in performance due to any such cause, the date of delivery or time for completion shall be extended by a period of time reasonably necessary to overcome the effect of such delay, and TWMC shall be reimbursed for any additional expense(s) resulting from such delay. The Purchaser's receipt of products shall constitute a waiver of any claims related to the delay.

Warranty

Standard Warranty

TWMC warrants that the equipment furnished hereunder will be of the kind and quality described in its proposal or contract and will be free of defects in workmanship and material.

The warranty period for stock motors is one (1) year after the date of purchase, or thirty-six (36) months from the date of manufacture, whichever is earlier. Motors of 20 horse power or less are covered under a "No Fault" warranty. This warranty claim is offered one time per end user, per application. If there is more than one failure, the standard warranty process will be followed.

All MAX-E2/841® motors have a 5-year warranty.

TWMC shall correct such nonconformity by repairing or replacing the defective part or parts, FOB factory or its designated repair facility at TWMC's option.

The Purchaser shall not be required to deliver a defective part to the seller if:

1. The part was destroyed as a result of its defect or of any defect in any part covered in this warranty, and
2. The seller is reasonably satisfied that the part was defective at the time of sale. If both these conditions are met the seller shall replace the part in the same manner as if the Purchaser had delivered it into the seller's plant.

This warranty is conditioned upon the storage, installation, operation,

and maintenance of the equipment in accordance with any TWMC recommendations and standard industry practice. Other exceptions to the standard warranty where applicable will be specified on the product page in the price book where they apply.

In no event shall TWMC be responsible for:

1. Providing working access to the defect, including the removal disassembly, replacement or reinstallation of any equipment, materials or structures to the extent necessary to permit TWMC to perform its warranty obligations,
2. Transportation costs to and from the TWMC factory or designated repair facility,
3. The conditions of any test shall be mutually agreed upon, and TWMC shall be notified of, and may be present at all tests that may be made,
4. Repairs performed without authorization by TWMC.

Merger Clause

Any representation, warranty, course of dealing, or trade usage not contained or referenced herein shall not be binding on TWMC. This writing, along with any additional parol agreements favoring TWMC, constitutes the entire agreement of the parties on the subject matter hereof. No modification, amendment, rescission, waiver, or other change shall be binding on TWMC unless expressly assented to in writing by TWMC.

DISCLAIMER OF WARRANTIES: THE WARRANTIES SET FORTH IN THIS PROVISION ARE EXCLUSIVE AND IN LIEU OF ALL OTHER WARRANTIES WHETHER STATUTORY, EXPRESS OR IMPLIED (INCLUDING ALL WARRANTIES OF MERCHANTABILITY OR FITNESS FOR A PARTICULAR PURPOSE AND ALL WARRANTIES ARISING FROM COURSE OF DEALING OR USAGE OF TRADE EXCEPT OF TITLE AND AGAINST PATENT INFRINGEMENT.

The remedies provided above are the Purchaser's sole remedies for any failure of TWMC to comply with its obligations. Correction of any nonconformity in the manner and for the period of time provided above shall constitute complete fulfillment of all the liabilities of TWMC whether the claims of the Purchaser are based in contract, in tort (including negligence or strict liability) otherwise with respect to or arising out of the product furnished hereunder.

Limitation of Liability

TWMC, its subcontractors and suppliers of any tier, shall not be liable in contract, in tort (including negligence or strict liability) or otherwise for interruption of business, downtime costs, loss of profits or revenues, loss of use of equipment or power system, cost of capital, cost of purchased or replacement power or temporary equipment (including additional expenses incurred in using the existing facilities), claims of customers of Purchaser, or for any special, indirect, incidental, or consequential damages whatsoever.

The remedies of the Purchaser set forth herein are exclusive and the total cumulative liability of TWMC with respect to any contract, or any action taken in connection therewith such as the performance or breach thereof, or from the manufacture, sale, delivery, resale, or use of any product covered by or furnished under the order, whether in contract, in tort (including negligence or strict liability) or otherwise shall not exceed the price of the product or part on which such liability is based.

Patents

Subject to the following provisions, TWMC shall, at its own expense, defend or at its option settle any claim, suit or proceeding brought against the Purchaser, and/or its customers, so far as based on an allegation that any product constitutes a direct or contributory infringement of any claim of any patent of the United States in force at the time of sale. This obligation shall be effective

STOCK MOTOR SELLING POLICY

Effective: 01-01-2022
Supercedes: 07-06-2021

only if Purchaser shall have made all payments then due hereunder and if TWMC is notified promptly in writing and given authority, information, and assistance for the defense of said claim, suit, or proceeding.

TWMC shall pay all damages and costs awarded in such suit or proceeding so defended.

1. In case the use or sale of such product or parts is enjoined, TWMC shall, at its option and its own expense perform one of the following actions:
 - a. Procure for the Purchaser the right to continue using said product or part thereof; or
 - b. Replace it with a non-infringing product; or
 - c. Modify it so it becomes noninfringing, or
 - d. As a last resort, refund the purchase price.
2. The foregoing indemnity does not apply to the following items:
 - a. Patented processes performed by the product, or any product produced thereby,
 - b. Products supplied according to a design other than that of TWMC's and which is required by the Purchaser,
 - c. Combinations of the product with another product not furnished hereunder unless TWMC is a contributory infringer,
 - d. Any settlement of a suit or proceeding made without TWMC's written consent.

The foregoing states the entire liability of TWMC with respect to patent infringement by said product or any part thereof. If a suit or proceeding is brought against TWMC solely on account of activities enumerated in paragraph 2 a, b, c, above, the Purchaser agrees to indemnify TWMC in the manner and to the extent

TWMC indemnified the Purchaser for products furnished.

Additional Conditions Applicable to Nuclear Applications

1. In the event that the Purchaser or third parties use product or any part thereof, in connection with any activity or process involving nuclear fission or fusion or any use or handling of any source, special nuclear or byproduct material as those materials are defined in the US Atomic Energy Act of 1954 as amended, the Purchaser, at no expense to TWMC shall provide or arrange for insurance coverage, indemnities, waivers of liability, recourse and subrogation in such amounts and under such terms and conditions as may be acceptable to TWMC, to protect TWMC (and its subsidiaries, subcontractors or suppliers of any tier) against any and all loss, cost, damage or expense and claims and demands therefore, in contract, in tort or otherwise, including the cost of investigating, litigating and/or settling any such claims or demands, on account of bodily injury, sickness, disease or death to any person or the loss of, loss of use of, or damage to property whether located on or off the site of a nuclear installation, arising out of, or resulting from the radioactive, toxic, explosive or other hazardous properties of source, special nuclear or byproduct materials, as those materials are defined in the US Atomic Energy Act of 1954 as amended.
2. In the event that the Purchaser resells, distributes or in any way relinquishes control of the product or services to a third party, the Purchaser shall require from such third party
 - a. Compliance with all requirements under Additional Conditions Applicable to Nuclear Applications Section 1 above and

- b. Assurance that any subsequent Purchaser of the product or services complies with all requirements under Additional Conditions Applicable to Nuclear Applications Section 1 above.

Interpretation

All orders shall be interpreted in accordance with the laws of the State of Texas.

TECO-WESTINGHOUSE STOCK MOTOR PRODUCTS WARRANTY POLICY AND PROCEDURE FOR WARRANTY CLAIMS ON STOCK MOTORS

Effective: 01-01-2022
Supercedes: 07-06-2021

STOCK MOTOR WARRANTY POLICY

All TECO-Westinghouse brand Stock Motors sold by TECO-Westinghouse are warranted to be free from defects in material and workmanship. The warranty period for high efficiency motors is one (1) year after the date of purchase, or thirty-six (36) months from the date of manufacture, which ever is earlier. Motors of 20 horse power or less are covered under a "no Fault" warranty. This warranty claim is offered one time per end user, per application. If there is more than one failure, the standard warranty process will be followed.

All MAX-E2/841® motors have a 5-year warranty.

This warranty is conditioned upon the proper storage, installation, operation, and maintenance of the motors in accordance with TECO-Westinghouse's recommendations or standard industry practice, and the motors have at all times been operated or used under normal operating conditions for which they were designed. This warranty will not be applicable to products that have been altered without written permission from TECO-Westinghouse.

TECO-Westinghouse shall, at its sole option and expense, either replace, refund, or have repairs made at a TECO-Westinghouse designated service center, any such motor or motor parts which are defective within the warranty period. TECO-Westinghouse warranty does not cover any shipping or transportation of a motor to or from TECO-Westinghouse, or designated service centers.

In the event of warranty claims, TECO-Westinghouse must be notified promptly following any motor failure. The motor or shall be sent to a TECO-Westinghouse authorized service center for diagnosis on the cause of failure. If the failure is due to defective material and/or workmanship, TECO-Westinghouse will replace or repair the defective motor or motor part at its discretion. TECO-Westinghouse warranty does not cover any work or repairs not authorized by TECO-Westinghouse warranty representatives. If the cause of the failure is determined to NOT be a result of manufacturer's defect or workmanship, all expenses associated with inspection, repair, and so forth, will be the responsibility of others.

The repair or replacement of defective material and workmanship shall constitute complete fulfillment of TECO-Westinghouse's warranty liability whether the warranty claims are based on contract, tort (including negligence and strict liability), or otherwise. **THERE ARE NO OTHER WARRANTIES, EXPRESSED OR IMPLIED, INCLUDING ANY IMPLIED WARRANTY OF MERCHANTABILITY AND FITNESS FOR PARTICULAR PURPOSE, AND ALL WARRANTIES ARISING FROM COURSE OF DEALING AND USAGE OF TRADE. UNDER NO CIRCUMSTANCES SHALL TECO-WESTINGHOUSE MOTOR COMPANY BE LIABLE FOR ANY SPECIAL, INDIRECT, INCIDENTAL, OR CONSEQUENTIAL DAMAGES, INCLUDING FREIGHT.**

STOCK MOTOR PRODUCTS RETURN POLICY

All returned goods are subject to prior approval and must be accompanied by a Return Material Authorization (RMA) number. These goods must be returned within 90 days, freight prepaid, in resalable condition and in original packaging. A 15% restocking fee will be applied. If upon receipt of the RMA, goods are deemed not to be in resalable condition or in original packaging, then additional fees will be applied. **RETURNS ON MODIFIED MOTORS OR CONTROL PRODUCTS WILL NOT BE ALLOWED.**

PROCEDURE FOR WARRANTY CLAIMS ON STOCK MOTORS

Effective: 01-01-2022
Supersedes: 07-06-2021

STOCK MOTOR PRODUCTS RETURN POLICY

In the event of a warranty claim, TECO-Westinghouse Motor Company must be notified within 30 days of indicated failure to process repair or replacement of motor. Original purchase information will be requested. The failed motor shall be sent to a TECO-Westinghouse authorized service center for diagnosis on the cause of the failure. EASA Certified Shops can be found at **Easa.com** using the "find a member" search feature. If the failure is due to defective material and/or workmanship, TWMC shall, at its sole option, either repair on a straight time basis, issue credit, or replace, FOB Warehouse any such motor or component that is defective within the warranty period. Failure to notify TWMC prior to performing repairs or providing replacements will result in denial of warranty claims.

Contact the TWMC Warranty Department at (512) 218-7475.
or through email - tframewarranty@tecowestinghouse.com

AUTHORIZED SERVICE

Authorized service centers shall contact TWMC's Warranty Department for serial number verification to determine warranty status of the motor. If the motor is within the original warranty period, the service center shall dismantle and inspect the motor, and prepare a standard EASA Warranty Repair Report. Email the report to Stock Product Warranty Email, tframewarranty@tecowestinghouse.com, for review of the failure and determination if the failure will be covered under terms of the TWMC standard warranty.

TO START A WARRANTY CLAIM

Email Information to tframewarranty@tecowestinghouse.com and we will advise of the next steps.

Subject Line: Include CAT#, your company name, PO# or serial number.

Complete information will be processed first. Incomplete information will not be saved. When asking for status or providing additional information, please include the information below so it is clear which claim you are referencing.

- Picture of the nameplate.
- Verify and record **serial** number.
- Verify and record catalog (CAT) number.
- Picture of motor and failure.
- Who purchased the motor from TWMC?
- **PO# or Order#** of failed motor.
- Description of **failure**.
- Was the motor run across the line, VFD, or soft start?
- What **is the motor operating?**
- How long was the motor in service?
- **EASA report** or short form completely filled out.
- Name of EASA shop if applicable.
- **Inspection fee** amount if applicable.
- **Estimate** of repairs if applicable.

WARRANTY DETERMINATION

If the motor failure is determined to be a warranty failure, a Warranty Claim Authorization (WCA) number will be assigned to the claim. The WCA number represents the credit memo number for any motor not repaired, as well as the purchase order number for inspection, and/or repair charges for motors to be replaced or repaired. Charges for inspections and/or repairs to motors outside the warranty period or for failures not resulting from material or workmanship issues are the sole responsibility of the end user.

For Warranty Repairs: The original EASA Warranty Repair Report, along with pictures documenting the failure, shall be submitted to the TWMC's Warranty Department, along with an invoice for all repair charges. All reports and invoices submitted require an RMA number for processing. Claims submitted without RMA numbers will be denied.

For Warranty Credit: The original EASA Warranty Repair Report, pictures, invoice and the original nameplate off the motor must be returned to TWMC's Warranty Department prior to issuance of credit. All claims and invoices submitted require an WCA number for processing. Claims submitted without WCA numbers will be denied. An invoice must be received for payment of inspection charges. Invoice only for inspection charges. Credit will be issued to the buyers account for any motor determined not repairable.

Request for Warranty Replacements: In special circumstances, TWMC's Warranty Department can approve replacement orders, if an exact replacement motor/component is in stock. If a warranty replacement motor is needed and approved, a new purchase order, with reference to the warranty claim number will need to be emailed to orders@tecowestinghouse.com for processing and shipment. All such orders will be shipped FOB warehouse, and the customer will receive an invoice for the replacement. Upon receipt of the nameplate off the original failed motor, credit will be issued for the failed motor. Freight is not covered under warranty.

NOTE: If the cause of the failure is determined to not be a result of manufacturer's defect or workmanship, all expenses associated with inspection, repair, etc., will be the responsibility of others.

TECO-WESTINGHOUSE STOCK MOTOR AND CONTROL PRODUCTS WARRANTY POLICY AND PROCEDURE FOR WARRANTY CLAIMS ON STOCK MOTORS

Effective: 01-01-2022
Supersedes: 07-06-2021

STOCK MOTOR AND CONTROL PRODUCT WARRANTY POLICY

All TECO-Westinghouse brand Stock Motors sold by TECO-Westinghouse are warranted to be free from defects in material and workmanship. The warranty period for high efficiency motors is one (1) year after the date of purchase, or thirty-six (36) months from the date of manufacture, whichever is earlier.

Motors of 20 horsepower or less are covered under a "No Fault" warranty. This warranty claim is offered one time per end user, per application. If there is more than one failure, the standard warranty process will be followed.

All MAX-E2/841® motors have a 5-year warranty.

This warranty is conditioned upon the proper storage, installation, operation, and maintenance of the motors in accordance with TECO-Westinghouse's recommendations or standard industry practice, and the motors have at all times been operated or used under normal operating conditions for which they were designed. This warranty will not be applicable to products that have been altered without written permission from TECO-Westinghouse.

TECO-Westinghouse shall, at its sole option and expense, either replace, refund, or have repairs made at a TECO-Westinghouse designated service center, any such motor or motor parts which are defective within the warranty period. TECO-Westinghouse warranty does not cover any shipping or transportation of a motor to or from TECO-Westinghouse, or designated service centers.

In the event of warranty claims, TECO-Westinghouse must be notified promptly following any motor failure. The motor shall be sent to a TECO-Westinghouse authorized service center for diagnosis on the cause of failure. If the failure is due to defective material and/or workmanship, TECO-Westinghouse will replace or repair the defective motor or motor part at its discretion. TECO-Westinghouse warranty does not cover any work or repairs not authorized by TECO-Westinghouse warranty representatives. If the cause of the failure is determined to NOT be a result of manufacturer's defect or workmanship, all expenses associated with inspection, repair, and so forth, will be the responsibility of others.

The repair or replacement of defective material and workmanship shall constitute complete fulfillment of TECO-Westinghouse's warranty liability whether the warranty claims are based on contract, tort (including negligence and strict liability), or otherwise. **THERE ARE NO OTHER WARRANTIES, EXPRESSED OR IMPLIED, INCLUDING ANY IMPLIED WARRANTY OF MERCHANTABILITY AND FITNESS FOR PARTICULAR PURPOSE, AND ALL WARRANTIES ARISING FROM COURSE OF DEALING AND USAGE OF TRADE. UNDER NO CIRCUMSTANCES SHALL TECO-WESTINGHOUSE MOTOR COMPANY BE LIABLE FOR ANY SPECIAL, INDIRECT, INCIDENTAL, OR CONSEQUENTIAL DAMAGES, INCLUDING FREIGHT.**

STOCK MOTOR AND CONTROL PRODUCTS RETURN POLICY

All returned goods are subject to prior approval and must be accompanied by a Return Material Authorization (RMA) number. These goods must be returned within 90 days, freight prepaid, in resalable condition and in original packaging. A 15% restocking fee will be applied. If upon receipt of the RMA, goods are deemed not to be in resalable condition or in original packaging, then additional fees will be applied. **RETURNS ON MODIFIED MOTORS WILL NOT BE ALLOWED.**

TECO-WESTINGHOUSE DRIVES AND CONTROLS WARRANTY POLICY

Effective: 01-01-2022
Supersedes: 07-06-2021

DRIVE AND CONTROLS WARRANTY POLICY

All TECO-Westinghouse brand Low Voltage Control Products, such as Solid State Starters and AC Drives, sold by TECO-Westinghouse are warranted to be free from defects in material and workmanship for a period of 36 months from the date of purchase. This warranty is conditioned upon the installation, operation, and maintenance of the control products in accordance with TECO-Westinghouse Motor Company's recommendations, Application Guidelines.

TECO-Westinghouse shall, at its sole option and expense, either repair, replace, or refund any control product which is defective within the warranty period. This warranty does not cover any shipping or transportation of control products to or from TECO-Westinghouse. This warranty will not be applicable to products that have been altered without written permission from TECO-Westinghouse.

In the event of warranty claims, TECO-Westinghouse must be notified promptly following any control product failure. All control product failures will follow the Controls RMA Return Procedure. TECO-Westinghouse warranty does not cover any work or repairs not authorized by TECO-Westinghouse warranty representatives. If the cause of the failure is determined to NOT be a result of manufacturer's defect or workmanship, all expenses associated with inspection, repair, and so forth, will be the responsibility of others.

The repair or replacement of defective material and workmanship shall constitute complete fulfillment of TECO-Westinghouse Motor Company's warranty liability whether the warranty claims are based on contract, tort (including negligence and strict liability), or otherwise. **THERE ARE NO OTHER WARRANTIES, EXPRESSED OR IMPLIED, INCLUDING ANY IMPLIED WARRANTY OF MERCHANTABILITY AND FITNESS FOR PARTICULAR PURPOSE, AND ALL WARRANTIES ARISING FROM COURSE OF DEALING AND USAGE OF TRADE. UNDER NO CIRCUMSTANCES SHALL TECO-WESTINGHOUSE MOTOR COMPANY BE LIABLE FOR ANY SPECIAL, INDIRECT, INCIDENTAL, OR CONSEQUENTIAL DAMAGES, INCLUDING FREIGHT.**

STOCK MOTOR AND CONTROL PRODUCTS RETURN POLICY

All returned goods are subject to prior approval and must be accompanied by a Return Material Authorization (RMA) number. These goods must be returned within 90 days, freight prepaid, in resalable condition and in original packaging. A 15% restocking fee will be applied. If upon receipt of the RMA, goods are deemed not to be in resalable condition or in original packaging, then additional fees will be applied.

RETURNS ON MODIFIED MOTORS OR CONTROL PRODUCTS WILL NOT BE ALLOWED

HVAC SINGLE PHASE ODP



BSGS39, NEMA PREMIUM [SP/SPH]

Effective: 01-01-2022
Supersedes: 07-06-2021

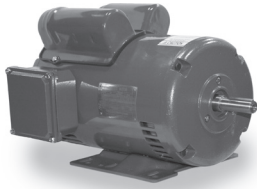

APPLICATIONS:

- Fans
- Pumps
- Compressors
- Air Conditioning Blowers
- Heating
- Ventilation

FEATURES:

- Output Range: 1/4 - 3 HP
- Speed: 3600 & 1800 RPM
- Enclosure: Open Drip Proof (IP22)
- Voltage: 115/208/230V (Tri-Voltage)
- Single Phase, 60 Hz; 1.15 Service Factor for 115V & 230V or 1.0 Service Factor for 208V
- Capacitor Start, Capacitor Run
- Class F Insulation
- Automatic Reset Overload
- Class B Temperature Rise
- Designed for 40°C Ambient Temperature⁽¹⁾
- Designed for 3300 ft. Elevation⁽²⁾
- Bi-Directional Rotation
- Rolled Steel Frame
- Cast Aluminum Terminal Box
- 1045 Carbon Steel Shaft
- Aluminum Die Cast Squirrel Cage Rotor Construction
- Paint System: Phenolic Rust Proof Base Plus Lacquer Top Coat
- Paint Color: Blue - Munsell 5 PB 3/8
- Double Shielded Bearings Pre-Packed with Lithium Base Grease
- No Terminals; Lead ends pre-scored for easy insulation removal
- Grounding Terminal Inside Main Box
- Stainless Steel Nameplate
- Motors are UL Recognized for United States and Canada

EXTRAS/ OPTIONS:

Please refer to pages 147 - 152 for common modifications that can be performed.

Notes:

1. Consult a Stock Product Application Specialist for suitability in higher ambient environments.
2. Consult a Stock Product Application Specialist for suitability at higher elevations.

HVAC SINGLE PHASE ODP



BSGS39, NEMA PREMIUM [SP/SPH]

Effective: 01-01-2022
Supersedes: 07-06-2021

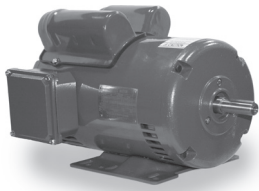

CATALOG NUMBER	HP	RPM	FRAME	FL EFF %	FL PF %	FL AMPS (230V)	APPROX. SHIPPING WT. (lbs.)	LIST PRICE (\$)
SP0/22	1/4	3600	48	66.0	90.0	1.31	25	354
SPH0/22	1/4	3600	56	66.0	90.0	1.31	26	386
SP0/24	1/4	1800	48	68.5	81.0	1.41	26	372
SPH0/24	1/4	1800	56	68.5	81.0	1.41	26	386
SP0/32	1/3	3600	48	70.5	90.0	1.71	26	392
SPH0/32	1/3	3600	56	70.5	90.0	1.71	26	402
SP0/34	1/3	1800	48	72.4	81.0	1.85	27	394
SPH0/34	1/3	1800	56	72.4	81.0	1.85	31	412
SP0/52	1/2	3600	48	72.4	90.0	2.47	29	414
SPH0/52	1/2	3600	56	72.4	90.0	2.47	29	455
SP0/54	1/2	1800	48	76.2	83.0	2.54	34	417
SPH0/54	1/2	1800	56	76.2	83.0	2.54	34	437
SP0/72	3/4	3600	48	76.2	92.0	3.41	33	457
SPH0/72	3/4	3600	56	76.2	92.0	3.41	33	497
SP0/74	3/4	1800	143/145T	81.8	90.0	3.25	42	546
SPH0/74	3/4	1800	56H	81.8	90.0	3.25	44	548
SPH0012	1	3600	56/56H	80.4	92.0	4.41	37	550
SP0012	1	3600	143/145T	80.4	92.0	4.41	38	566
SPH0014	1	1800	56/56H	82.6	90.0	4.39	47	620
SP0014	1	1800	143/145T	82.6	90.0	4.39	47	665
SPH1/52	1.5	3600	56/56H	81.5	96.0	6.11	42	603
SP1/52	1.5	3600	143/145T	81.5	96.0	6.11	42	622
SPH1/54	1.5	1800	56/56H	83.8	96.0	5.94	55	712
SP1/54	1.5	1800	143/145T	83.8	96.0	5.94	55	802
SPH0022	2	3600	56/56H	82.9	96.0	8.19	45	641
SP0022	2	3600	143/145T	82.9	96.0	8.19	45	647
SPH0024	2	1800	56/56H	84.5	96.0	8.04	62	811
SP0024	2	1800	143/145T	84.5	96.0	8.04	63	945
SPH0032	3	3600	56/56H	84.1	98.0	11.6	55	662
SP0032	3	3600	143/145T	84.1	98.0	11.6	55	703

Note:

(1) Data subject to change without notice.

HVAC SINGLE PHASE TEFC



BEGS39, NEMA PREMIUM (1/4 HP - 3 HP) [SPT/SPHT]

Effective: 01-01-2022

BEGS19, ENERGY EFFICIENT (3 HP - 10 HP) [ST]

Supersedes: 07-06-2021



APPLICATIONS:

- Fans
- Pumps
- Compressors
- Air Conditioning Blowers
- Heating
- Ventilation

FEATURES:

- Output Range: 1/4 - 10 HP
- Speed: 3600 & 1800 RPM
- Enclosure: Totally Enclosed Fan Cooled (IP44)
- Voltage: 115/208/230V (Tri-Voltage); 3 HP and Larger are 208-230V
- Single Phase, 60 Hz; 1.15 Service Factor for 115V & 230V or 1.0 Service Factor for 208V
- Capacitor Start, Capacitor Run
- Class F Insulation
- Automatic Reset Overload
- Class B Temperature Rise
- Designed for 40°C Ambient Temperature¹
- Designed for 3300 ft. Elevation²
- Bi-Directional Rotation
- Rolled Steel Frame
- Cast Aluminum Terminal Box
- 1045 Carbon Steel Shaft
- Aluminum Die Cast Squirrel Cage Rotor Construction
- Paint System: Phenolic Rust Proof Base Plus Lacquer Top Coat
- Paint Color: Blue - Munsell 5 PB 3/8
- Double Shielded Bearings Pre-Packed with Lithium Base Grease
- No Terminals; Lead ends pre-scored for easy insulation removal
- Grounding Terminal Inside Main Box
- Stainless Steel Nameplate
- Motors are UL Recognized for United States and Canada

EXTRAS/ OPTIONS:

- Please refer to pages 147 - 152 for common modifications that can be performed.

Notes:

1. Consult a Stock Product Application Specialist for suitability in higher ambient environments.
2. Consult a Stock Product Application Specialist for suitability at higher elevations.

HVAC SINGLE PHASE TEFC



BEGS39, NEMA PREMIUM (1/4 HP - 3 HP) [SPT/SPHT]

Effective: 01-01-2022

BEGS19, ENERGY EFFICIENT (3 HP - 10 HP) [ST]

Supersedes: 07-06-2021



CATALOG NUMBER	HP	RPM	FRAME	FL EFF %	FL PF %	FL AMPS (230V)	APPROX. SHIPPING WT. (lbs.)	LIST PRICE (\$)
SPT0/22	1/4	3600	48	68.0	90.0	1.28	23	402
SPHT0/22	1/4	3600	56	68.0	90.0	1.28	23	417
SPT0/24	1/4	1800	48	70.0	83.0	1.35	24	417
SPHT0/24	1/4	1800	56	70.0	83.0	1.35	24	432
SPT0/32	1/3	3600	48	72.0	90.0	1.68	24	417
SPHT0/32	1/3	3600	56	72.0	90.0	1.68	24	432
SPT0/34	1/3	1800	48	74.0	83.0	1.77	25	425
SPHT0/34	1/3	1800	56	74.0	83.0	1.77	25	462
SPT0/52	1/2	3600	48	74.0	90.0	2.42	27	454
SPHT0/52	1/2	3600	56	74.0	90.0	2.42	27	468
SPT0/54	1/2	1800	48	77.0	85.0	2.46	29	462
SPHT0/54	1/2	1800	56	77.0	85.0	2.46	29	468
SPT0/72	3/4	3600	48	77.0	92.0	3.38	30	485
SPHT0/72	3/4	3600	56	77.0	92.0	3.38	30	506
SPT0/74	3/4	1800	48	78.5	87.0	3.50	32	491
SPHT0/74	3/4	1800	56	78.5	87.0	3.50	32	514
SPHT0012	1	3600	56/56H	78.5	92.0	4.51	38	542
SPT0012	1	3600	143/145T	78.5	92.0	4.51	38	559
SPHT0014	1	1800	56/56H	80.0	90.0	4.53	41	619
SPT0014	1	1800	143/145T	80.0	90.0	4.53	42	624
SPHT1/52	1.5	3600	56/56H	81.5	96.0	6.11	42	595
SPT1/52	1.5	3600	143/145T	81.5	96.0	6.11	43	610
SPHT1/54	1.5	1800	56/56H	81.5	92.0	6.38	46	701
SPT1/54	1.5	1800	143/145T	81.5	92.0	6.38	47	666
SPHT0022	2	3600	56/56H	82.5	96.0	8.23	45	647
SPT0022	2	3600	143/145T	82.5	96.0	8.23	45	663
SPHT0024	2	1800	56/56H	82.5	92.0	8.59	54	781
SPT0024	2	1800	143/145T	82.5	92.0	8.59	54	707
SPHT0032	3	3600	56/56H	84.0	98.0	11.7	56	685
SPT0032	3	3600	143/145T	84.0	98.0	11.7	56	666
ST0032 ⁽¹⁾	3	1800	182/184T	80.0	96.0	12.5	97	1,115
ST0034 ⁽¹⁾	3	1800	182/184T	82.5	92.0	12.6	97	1,096
ST0052 ⁽¹⁾	5	3600	182/184T	82.0	98.0	20.0	112	1,170
ST0054 ⁽¹⁾	5	1800	182/184T	84.0	94.0	20.4	117	1,295
ST7/52 ⁽¹⁾	7.5	3600	213/215T	84.5	98.0	28.9	160	1,906
ST7/54 ⁽¹⁾	7.5	1800	213/215T	82.0	94.0	31.1	188	2,248
ST0102 ⁽¹⁾	10	3600	213/215T	86.0	98.0	38.7	195	2,218
ST0104 ⁽¹⁾	10	1800	213/215T	83.5	94.0	41.6	215	2,665

Notes:

- (1) Energy Efficient.
- (2) Data subject to change without notice.

FARM DUTY SINGLE PHASE



BEGCFD, HIGH EFFICIENCY (1/3 HP - 1 HP) [S]

BECCFD, HIGH EFFICIENCY (1.5 HP) [S]

BECSFD, HIGH EFFICIENCY (2 HP -10 HP) [S]

Effective: 01-01-2022

Supersedes: 07-06-2021



APPLICATIONS:

- Fans & Blowers
- Pumps
- Compressors
- Farm Equipment
- Machine Tools

FEATURES:

- Output Range: 1/3 - 10 HP
- Speed: 1800 RPM
- Enclosure: Totally Enclosed Fan Cooled (IP44)
- Voltage: 115/230V (3 HP and Larger are 230V Only)
- Single Phase, 60 Hz, 1.15 Service Factor (Continuous)
- Definite Purpose High Torque Farm Duty Design
- Capacitor Start, Induction Run - 1/3 HP to 1.5 HP
- Capacitor Start, Permanent Split Capacitor Run - 2 HP to 10 HP
- Class B Insulation from 1/3 HP to 3 HP
- Class F Insulation from 5 HP to 10 HP
- Manual Reset Overload with Outside Rubber Boot
- Class B Temperature Rise
- Designed for 40°C Ambient Temperature¹
- Designed for 3300 ft. Elevation²
- Bi-Directional Rotation
- Rolled Steel Frame for 1/3 - 1 HP
- Cast Iron Frame for 1.5 - 10 HP
- Rolled Steel Terminal Box
- 1045 Carbon Steel Shaft
- Aluminum Die Cast Squirrel Cage Rotor Construction
- Paint System: Phenolic Rust Proof Base Plus Polyurethane Top Coat
- Paint Color: Green - Munsell 5G 4/4
- Double Shielded Bearings Pre-Packed with MULTEMP SRL (Non-regreasable)
- Rubber Dust Flinger on DE
- Grounding Terminal Inside Main Box
- Stainless Steel Nameplate Frames 143T and Larger
- Motors are U.L. Recognized and CSA Approved

EXTRAS/ OPTIONS:

- Please refer to pages 147 - 152 for common modifications that can be performed.

Notes:

1. Consult a Stock Product Application Specialist for suitability in higher ambient environments.
2. Consult a Stock Product Application Specialist for suitability in higher elevations.

FARM DUTY SINGLE PHASE



BEGCFD, HIGH EFFICIENCY (1/3 HP - 1 HP) [S]
 BECCFD, HIGH EFFICIENCY (1.5 HP) [S]
 BECSFD, HIGH EFFICIENCY (2 HP -10 HP) [S]

Effective: 01-01-2022
 Supersedes: 07-06-2021

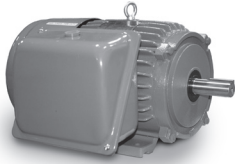

HP	RPM	FL EFF %	FL PF %	FRAME MATERIAL ⁴	FOOTED FRAME				FOOTED C-FACE			
					FRAME	CATALOG NUMBER	APPROX. SHIPPING WT. (lbs.)	LIST PRICE (\$)	FRAME	CATALOG NUMBER	APPROX. SHIPPING WT. (lbs.)	LIST PRICE (\$)
1/3	1800	51.0	47.0	RS	56	S0/34 ⁽¹⁾	29	453	56C	S0/34C ⁽¹⁾	29	635
1/2	1800	58.0	58.0	RS	56	S0/54 ⁽¹⁾	33	480	56C	S0/54C ⁽¹⁾	33	663
3/4	1800	65.0	63.0	RS	56	S0/74 ⁽¹⁾	38	493	56C	S0/74C ⁽¹⁾	38	692
1	1800	69.0	68.0	RS	56	S0014 ⁽¹⁾	50	498	56C	S0014C ⁽¹⁾	50	727
1.5	1800	70.0	63.0	CI	145T	S1/54 ⁽¹⁾	73	703	145TC	S1/54C ⁽¹⁾	73	839
2	1800	73.0	63.5	CI ⁽²⁾	182T	S0024 ⁽²⁾	120	921	182TC	S0024C ⁽²⁾	120	1,163
3	1800	74.0	63.0	CI ⁽²⁾	182T	S0034 ⁽²⁾⁽³⁾	120	1,045	182TC	S0034C ⁽²⁾⁽³⁾	120	1,285
5	1800	78.5	69.0	CI ⁽²⁾	184T	S0054 ⁽²⁾⁽³⁾	135	1,192	184TC	S0054C ⁽²⁾⁽³⁾	135	1,429
7.5	1800	80.0	84.5	CI ⁽²⁾	213T	S7/54 ⁽²⁾⁽³⁾	200	2,029	213TC	S7/54C ⁽²⁾⁽³⁾	200	2,248
10	1800	78.5	87.0	CI ⁽²⁾	215T	S0104 ⁽²⁾⁽³⁾	210	2,416	215TC	S0104C ⁽²⁾⁽³⁾	210	2,623

Notes:

1. BEGCFD and BECCFD are capacitor start, induction run.
2. BECSFD is capacitor start and permanent split capacitor run.
3. Ratings 3 HP and Larger are 230V only.
4. Frame Material: RS = Rolled Steel; CI = Cast Iron
5. Data subject to change without notice.

OIL WELL PUMP ODP



ASFAFP, STANDARD EFFICIENCY, DESIGN D [Q]

Effective: 01-01-2022
Supersedes: 07-06-2021

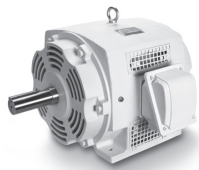

APPLICATIONS:

- Oil Well Pumps
- Any Applications Requiring NEMA Design D Torques

FEATURES:

- Output Range: 5 - 125 HP
- Speed: 1200 RPM
- Enclosure: Open Drip Proof (IP22)
- Voltage: 230/460/796V
- Three Phase, 60 Hz, 1.15 Service Factor (Continuous)
- Class F Insulation
- Class B Temperature Rise
- NEMA Design D Torques
- Cast Iron Frame, End Brackets and Main Conduit Box
- Grounding Terminal Inside Main Conduit Box with additional Foot Grounding Provision
- Oversized Main Conduit Box Rotatable in 90 Degree Increments - F2 Mounted, F1 Available with Modification
- Designed for 40°C Ambient Temperature¹
- Designed for 3300 ft. Elevation²
- Bi-Directional Rotation
- 1045 Carbon Steel Shaft
- Aluminum Die Cast Squirrel Cage Rotor Construction
- Paint System: Phenolic Rust Proof Base Plus Polyurethane Top Coat
- Paint Color: White - Munsell N9.5
- Double Shielded Bearings Pre-Packed with MULTEMP SRL for F# 280T and Smaller (Non-regreasable)
- High Quality Ball (or Roller) Bearings Regreasable with Mobil Polyrex™ EM for F# 320T and Larger
- Metal Flinger on Both Ends for Frames F# 320T and Larger
- Cast Iron Inner and Outer Bearing Caps for F# 324T and Larger
- Stainless Steel Nameplate
- 12 Leads
- Standard with Klixon 9700K Temperature Limiting Switch, 1 Per Phase
- 5% Minimum Slip
- Rodent Screens

EXTRAS/ OPTIONS:

- Please refer to pages 147 - 152 for common modifications that can be performed.

Notes:

1. Consult a Stock Product Application Specialist for suitability in higher ambient environments.
2. Consult a Stock Product Application Specialist for suitability at higher elevations.
3. All motors are NEMA Design D torque.

OIL WELL PUMP ODP



ASFAFP, STANDARD EFFICIENCY, DESIGN D [Q]

Effective: 01-01-2022
Supercedes: 07-06-2021



CATALOG NUMBER	HP	RPM	FRAME	FL EFF %	FL PF %	FL AMPS (460V)	APPROX. SHIPPING WT. (lbs.)	LIST PRICE (\$)
Q0056	5	1200	215T	81.5	77.0	7.45	205	1,439
Q7/56	7.5	1200	254T	85.5	82.0	10.0	270	2,016
Q0106	10	1200	256T	85.5	85.0	12.9	335	2,177
Q0156	15	1200	284T	87.5	86.0	18.7	410	3,118
Q0206	20	1200	286T	85.5	89.0	24.6	453	3,846
Q0256	25	1200	324T	86.5	89.0	30.4	620	4,612
Q0306	30	1200	326T	86.5	90.0	36.1	700	4,993
Q0406	40	1200	365T	89.5	90.0	46.5	795	6,935
Q0506	50	1200	404T	88.5	89.5	59.1	1,075	8,546
Q0606	60	1200	404T	89.5	90.0	70.0	1,165	9,810
Q0756	75	1200	405T	88.5	91.0	87.5	1,245	11,639
Q1006R	100	1200	444T	86.5	82.0	132	1,585	15,661
Q1256R	125	1200	445T	87.0	82.0	164	1,725	17,606

Notes:

1. "R" = Motor stocked standard with a Drive-End Roller Bearing.
2. Data subject to change without notice.

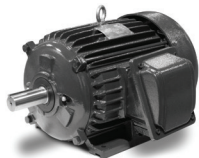

APPLICATIONS:

- Oil Well Pumps
- Any Applications Requiring NEMA Design D Torques

FEATURES:

- Output Range: 5 - 125 HP
- Speed: 1200 RPM
- Enclosure: Totally Enclosed Fan Cooled (IP54)
- Voltage: 230/460
- Three Phase, 60 Hz, 1.15 Service Factor (Continuous)
- Class F Insulation
- Class B Temperature Rise
- NEMA Design D Torques
- Cast Iron Frame, End Brackets, Fan Cover and Main Conduit Box
- Grounding Terminal Inside Main Conduit Box with additional Foot Grounding Provision
- Oversized Main Conduit Box Rotatable in 90 Degree Increments - F2 Mounted, F1 Available with Modification
- Designed for 40°C Ambient Temperature¹
- Designed for 3300 ft. Elevation²
- Bi-Directional Rotation
- 1045 Carbon Steel Shaft
- Aluminum Die Cast Squirrel Cage Rotor Construction
- Paint System: Phenolic Rust Proof Base Plus Polyurethane Top Coat
- Paint System: Phenolic Rust Proof Base with Alkyd Finish
- Paint Color: Dark Blue (Munsell 5PB 4.5/2)
- Double Shielded Bearings Pre-Packed with MULTEMP SRL for F# 280T and Smaller (Non-regreasable)
- High Quality Ball (or Roller) Bearings Regreasable with Mobil Polyrex™ EM for F# 320T and Larger
- Metal Flinger on Both Ends for Frames F# 320T and Larger
- Cast Iron Inner and Outer Bearing Caps for F# 324T and Larger
- Stainless Steel Nameplate
- 12 Leads
- Standard with Klixon 9700K Temperature Limiting Switch, 1 Per Phase
- 5% Minimum Slip

EXTRAS/ OPTIONS:

- Please refer to pages 147 - 152 for common modifications that can be performed.

Notes:

1. Consult a Stock Product Application Specialist for suitability in higher ambient environments.
2. Consult a Stock Product Application Specialist for suitability at higher elevations.
3. All motors are NEMA Design D torque.

OIL WELL PUMP TEFC



AEEAFP, STANDARD EFFICIENCY, DESIGN D [QT]

Effective: 01-01-2022
Supercedes: 07-06-2021



CATALOG NUMBER	HP	RPM	FRAME	FL EFF %	FL PF %	FL AMPS (460V)	APPROX. SHIPPING WT. (lbs.)	LIST PRICE (\$)
QT0056	5	1200	213/215T	83.5	81.5	6.88	155	2,018
QT7/56	7.5	1200	254T	83.5	83.0	10.1	270	2,295
QT0106	10	1200	254/256T	84.0	84.0	13.3	335	2,727
QT0156	15	1200	284T	85.5	88.0	18.7	410	3,392
QT0206	20	1200	284/286T	86.5	89.0	24.3	453	4,241
QT0256	25	1200	324T	87.0	88.0	30.6	620	4,967
QT0306	30	1200	324/326T	87.5	90.5	35.5	700	5,937
QT0406	40	1200	364/365T	88.5	89.0	47.5	795	7,997
QT0506	50	1200	404T	89.5	92.0	56.9	1,075	9,875
QT0606	60	1200	404/405T	90.0	92.0	67.8	1,165	11,208
QT0756	75	1200	444T	90.0	88.5	88.2	1,245	18,412
QT1006	100	1200	444/445T	90.5	89.0	116	1,585	22,515
QT1006R	100	1200	444/445T	90.5	89.0	116	1,585	22,515
QT1256	125	1200	445/447T	91.5	89.0	144	1,785	25,801
QT1256R	125	1200	445/447T	91.5	89.0	144	1,785	25,801

Notes:

1. "R" = Motor stocked standard with a Drive-End Roller Bearing.
2. Data subject to change without notice.

2 SPEED, 1 WINDING, VARIABLE TORQUE



AECA, HIGH EFFICIENCY [CP]

Effective: 01-01-2022
Supersedes: 07-06-2021

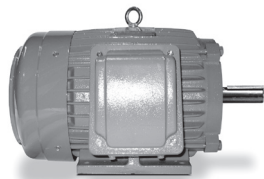

APPLICATIONS:

- Fans & Blowers
- Pumps
- Cooling Towers

FEATURES:

- Output Range: 100 - 300 HP
- Speeds: 1800 / 900 RPM
- Enclosure: Totally Enclosed Fan Cooled (IP55)
- Voltage: 460V Only
- Three Phase, 60 Hz, 1.15 Service Factor (Continuous)
- Self-Certified for Class I, Div. 2, Groups B, C, D
- Class F Insulation
- Class B Temperature Rise
- NEMA Design B Torques as a Minimum
- Cast Iron Frame, End Brackets, Fan Cover and Main Conduit Box⁴
- Grounding Terminal Inside Main Conduit Box with additional Foot Grounding Provision
- Oversized Main Conduit Box Rotatable in 90 Degree Increments - F1 Mounted
- Designed for 40°C Ambient Temperature¹
- Designed for 3300 ft. Elevation²
- Bi-Directional Rotation
- 1045 Carbon Steel Shaft
- Aluminum Die Cast Squirrel Cage Rotor Construction
- Paint System: 2 Part Epoxy
- Paint Color: Dark Gray - Munsell 7.5B 3.5/0.5
- Epoxy Coated Internals
- High Quality Ball (or Roller) Bearings Regreasable with Mobil Polyrex™ EM
- Automatic Grease Discharge Fittings
- Stainless Steel Nameplate and Hardware
- Stainless Steel Automatic Breather Drain
- 6 Leads Only
- Noise Level Not to Exceed 85 dB(A) at 1 Meter Unloaded
- 2 Speed, 1 Winding - Variable Torque
- High Efficiency, Severe Duty

EXTRAS/ OPTIONS:

- Please refer to pages 147 - 152 for common modifications that can be performed.

Notes:

1. Please consult factory for suitability in higher ambients.
2. Please consult factory for suitability in higher elevations.
3. Additional charge for Division II Auxiliary Nameplate - See Factory Modification sheet for pricing.*
4. Catalog# CP3004/8 (F#5009B) has steel fan cover.
5. Multi-speed motors are exempt from (DOE) Department of Energy premium efficiency requirements.

2 SPEED, 1 WINDING, VARIABLE TORQUE

AECA, HIGH EFFICIENCY [CP]

Effective: 01-01-2022

Supersedes: 07-06-2021



CATALOG NUMBER	HP	RPM	FRAME	FL EFF %	FL PF %	FL AMPS (460V)	APPROX. SHIPPING WT. (lbs.)	LIST PRICE (\$)
CP1004/8	100 / 25	1800/900	444T	92.5 / 88.0	90.0 / 62.0	112 / 42.9	1,855	22,756
CP1254/8	125 / 31	1800/900	444/445T	92.5 / 88.0	90.0 / 62.0	141 / 53.2	2,105	27,875
CP1504/8	150 / 37	1800/900	445/447T	93.0 / 90.0	90.0 / 62.0	168 / 62.9	2,647	34,133
CP2004/8	200 / 50	1800/900	447/449T	93.5 / 90.0	90.5 / 62.0	221 / 83.9	2,820	40,958
CP2504/8	250 / 62.5	1800/900	449T	94.0 / 90.0	90.5 / 62.0	275 / 105	2,820	51,199
CP3004/8	300 / 75	1800/900	5009B	94.5 / 92.0	91.0 / 72.0	327 / 106	4,125	58,921

Notes:

1. Data subject to change without notice.

ROLLED STEEL ODP FAMILY



ASGHPE, NEMA PREMIUM, F#56 (1/4 HP - 3 HP) [DSP]

ASGH, NEMA PREMIUM, F#140T - 280T (1 HP - 40 HP) [DTP]

ASGHJP/JM, NEMA PREMIUM, CLOSE COUPLED, (1 HP - 40 HP) [DJPP/DJMP]*

Effective: 01-01-2022

Supersedes: 07-06-2021

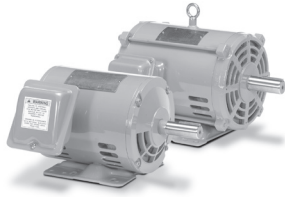

APPLICATIONS:

- Fans & Blowers
- Pumps
- HVAC Equipment
- Compressors
- Fire Pumps (See Option Below)



FIRE SAFETY

FEATURES:

- Output Range: 1/3 - 40 HP
- Speed: 3600, 1800 & 1200 RPM
- Enclosure: Open Drip Proof (IP22)
- Voltage: 230/460V (Usable on 200 & 208V)
- Three Phase, 60 Hz, 1.15 Service Factor (Continuous); 50 Hz, 1.0 Service Factor (Continuous)
- Class F Insulation
- Class B Temperature Rise
- NEMA Design B Torques
- Rolled Steel Frame and Main Conduit Box
- Grounding Terminal Inside Main Conduit Box
- Oversized Main Conduit Box Rotatable in 90 Degree Increments - F1 Mounted Only (F2 not available)
- Designed for 40°C Ambient Temperature¹
- Designed for 3300 ft. Elevation²
- Bi-Directional Rotation
- 1045 Carbon Steel Shaft
- Aluminum Die Cast Squirrel Cage Rotor Construction
- Paint System: Phenolic Rust Proof Base Plus Polyurethane Top Coat
- Paint Color: Light Gray - Munsell N5.0
- Double Shielded Bearings Pre-Packed with MULTEMP SRL (Non-regreasable)
- Stainless Steel Nameplate
- Dual Column Design Nameplate as Standard (60/50 Hz)
- Suitable for Inverter Use per NEMA MG-1.4.4.2, Part 31^{3,4}
- Inverter Duty Speed Range: 20:1 Variable Torque, 10:1 Constant Torque
- 9 Leads for 5 HP and Smaller
- 12 Leads for 7.5 HP and Larger
- Motors are U.L. Recognized for United States and Canada, CSA Approved and CE Marked

EXTRAS/ OPTIONS:

Notes:

- * Fire Pump available. See product page for more details.
- 1. Consult a Stock Product Application Specialist for suitability in higher ambient environments.
- 2. Consult a Stock Product Application Specialist for suitability at higher elevations.
- 3. Motor service factor is 1.0 when operated on a VFD.
- 4. Precautions should be taken to eliminate or reduce shaft currents that may be imposed on the motor by the VFD as stated per NEMA MG-1. Part 31.

ROLLED STEEL ODP PREMIUM



ASGHPE, NEMA PREMIUM, F#56 (1/4 HP - 3 HP) [DSP]

Effective: 01-01-2022

ASGH, NEMA PREMIUM, F#140T - 280T (1 HP - 40 HP) [DTP]

Supersedes: 07-06-2021

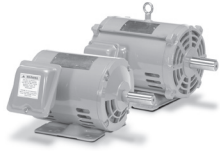

CATALOG NUMBER	HP	RPM	FRAME	FL EFF %	FL PF %	FL AMPS (230V)	APPROX. SHIPPING WT. (lbs.)	LIST PRICE (\$)
DSP0/22	1/4	3600	56	72.0	82.0	0.79	19	302
DSP0/24	1/4	1800	56	72.0	73.0	0.89	20	323
DSP0/26	1/4	1200	56	70.0	61.0	1.10	24	433
DSP0/32	1/3	3600	56	71.5	80.5	1.08	21	302
DSP0/34	1/3	1800	56	75.5	74.5	1.11	22	323
DSP0/36	1/3	1200	56	72.0	61.0	1.42	22	433
DSP0/52	1/2	3600	56	73.4	81.5	1.57	22	323
DSP0/54	1/2	1800	56	78.2	81.0	1.48	22	355
DSP0/56	1/2	1200	56	75.5	63.0	1.97	23	470
DSP0/72	3/4	3600	56	76.8	80.0	2.29	35	364
DSP0/74	3/4	1800	56	81.1	77.5	2.23	23	393
DSP0/76	3/4	1200	56	81.7	67.5	2.55	26	479
DSP0012	1	3600	56	77.0	79.5	3.06	25	421
DTP0012	1	3600	143/145T	80.0	85.5	2.74	34	444
DSP0014	1	1800	56	83.5	72.0	3.11	25	421
DTP0014	1	1800	143/145T	85.5	75.5	2.90	42	444
DSP0016	1	1200	56	82.5	66.0	3.44	32	499
DTP0016	1	1200	143/145T	82.5	66.0	3.44	43	573
DSP1/52	1.5	3600	56	85.5	83.0	3.96	26	451
DTP1/52	1.5	3600	143/145T	85.5	83.0	3.96	34	474
DSP1/54	1.5	1800	56	86.5	80.5	4.03	30	451
DTP1/54	1.5	1800	143/145T	86.5	80.5	4.03	47	491
DTP1/56	1.5	1200	182/184T	86.5	54.0	6.01	94	608
DSP0022	2	3600	56	86.5	85.0	5.09	28	479
DTP0022	2	3600	143/145T	85.5	89.0	4.92	42	535
DSP0024	2	1800	56	86.5	79.0	5.48	35	479
DTP0024	2	1800	143/145T	86.5	79.0	5.48	47	521
DTP0026	2	1200	182/184T	87.5	57.0	7.51	94	664
DSP0032	3	3600	56	86.5	89.0	7.30	36	578
DTP0032	3	3600	143/145T	85.5	86.0	7.64	42	597
DTP0034	3	1800	182/184T	89.5	73.0	8.60	94	587
DTP0036	3	1200	213/215T	88.5	69.0	9.20	158	927
DTP0052	5	3600	182/184T	87.5	88.0	12.2	94	676
DTP0054	5	1800	182/184T	89.5	77.0	13.6	94	718
DTP0056	5	1200	213/215T	89.5	73.0	14.3	158	1,118
DTP7/52	7.5	3600	182/184T	88.5	90.0	17.6	94	891
DTP7/54	7.5	1800	213/215T	91.0	81.0	19.1	158	1,030
DTP7/56	7.5	1200	254/256T	90.2	77.0	20.2	292	1,623
DTP0102	10	3600	213/215T	90.2	85.5	24.3	158	1,118
DTP0104	10	1800	213/215T	91.7	84.0	24.3	158	1,220
DTP0106	10	1200	254/256T	91.7	79.5	25.7	292	1,855
DTP0152	15	3600	213/215T	91.0	87.0	35.5	158	1,497
DTP0154	15	1800	254/256T	93.0	83.0	36.4	230	1,634
DTP0156	15	1200	284/286T	91.7	80.0	38.3	344	2,480
DTP0202	20	3600	254/256T	91.7	90.0	45.4	292	1,896
DTP0204	20	1800	254/256T	93.0	83.0	48.5	292	2,019
DTP0206	20	1200	284/286T	92.4	81.5	49.4	344	3,006
DTP0252	25	3600	254/256T	91.7	91.0	56.1	292	2,251
DTP0254	25	1800	284/286T	93.6	85.0	58.8	344	2,496
DTP0302	30	3600	284/286TS	92.4	90.0	67.6	344	2,782
DTP0304	30	1800	284/286T	94.1	86.0	69.4	415	2,934
DTP0402	40	3600	284/286TS	92.4	90.5	89.6	415	3,561

Notes:

- DSP0034 comes with the Premium Efficiency nameplate but does not have the NEMA Premium logo. DSP0034 meets DOE SMR rules for premium efficiency but not NEMA MG-1 Table 12.12.
- Data subject to change without notice.

ROLLED STEEL ODP JM PREMIUM



ASGHJM, NEMA PREMIUM, CLOSE COUPLED, (1 HP - 40 HP) [DJPP/DJMP]*

Effective: 01-01-2022
Supersedes: 07-06-2021

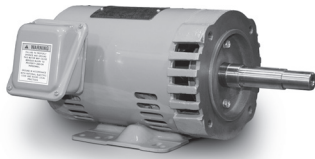

HP	RPM	FL EFF %	FL PF %	FL AMPS (230V)	DJPP				DJMP			
					FRAME	JP CATALOG NUMBER	APPROX. SHIPPING WT. (lbs.)	LIST PRICE (\$)	FRAME	JP CATALOG NUMBER	APPROX. SHIPPING WT. (lbs.)	LIST PRICE (\$)
1	1800	85.5	75.5	2.90	143/145JP	DJPP0014	40	531	143/145JM	DJMP0014	40	531
1	1200	82.5	66.0	3.44	143/145JP	DJPP0016	45	665	143/145JM	DJMP0016	45	665
1.5	3600	85.5	83.0	3.96	143/145JP	DJPP1/52	40	578	143/145JM	DJMP1/52	40	578
1.5	1800	86.5	80.5	4.03	143/145JP	DJPP1/54	47	587	143/145JM	DJMP1/54	47	587
1.5	1200	86.5	54.0	6.01	182/184JP	DJPP1/56	90	687	182/184JM	DJMP1/56	83	687
2	3600	86.5	85.0	5.09	143/145JP	DJPP0022	45	590	143/145JM	DJMP0022	45	590
2	1800	86.5	79.0	5.48	143/145JP	DJPP0024	50	590	143/145JM	DJMP0024	49	590
2	1200	87.5	57.0	7.51	182/184JP	DJPP0026	93	761	182/184JM	DJMP0026	89	761
3	3600	85.5	86.0	7.64	143/145JP	DJPP0032	50	748	143/145JM	DJMP0032	50	748
3	1800	89.5	73.0	8.60	182/184JP	DJPP0034	113	665	182/184JM	DJMP0034	95	665
3	1200	88.5	69.0	9.20	213/215JP	DJPP0036	155	1,064	213/215JM	DJMP0036	146	1,064
5	3600	87.5	88.0	12.2	182/184JP	DJPP0052	95	930	182/184JM	DJMP0052	78	930
5	1800	89.5	77.0	13.6	182/184JP	DJPP0054	113	785	182/184JM	DJMP0054	108	785
5	1200	89.5	73.0	14.3	213/215JP	DJPP0056	155	1,473	213/215JM	DJMP0056	146	1,473
7.5	3600	88.5	90.0	17.6	182/184JP	DJPP7/52	100	1,111	182/184JM	DJMP7/52	78	1,111
7.5	1800	91.0	81.0	19.1	213/215JP	DJPP7/54	155	1,128	213/215JM	DJMP7/54	140	1,126
7.5	1200	90.2	77.0	20.2	254/256JP	DJPP7/56	265	1,773	254/256JM	DJMP7/56	265	1,773
10	3600	90.2	85.5	24.3	213/215JP	DJPP0102	167	1,427	213/215JM	DJMP0102	165	1,427
10	1800	91.7	84.0	24.3	213/215JP	DJPP0104	180	1,256	213/215JM	DJMP0104	150	1,256
10	1200	91.7	79.5	25.7	254/256JP	DJPP0106	290	2,067	254/256JM	DJMP0106	275	2,067
15	3600	91.0	87.0	35.5	213/215JP	DJPP0152	167	1,882	213/215JM	DJMP0152	165	1,882
15	1800	93.0	83.0	36.4	254/256JP	DJPP0154	265	1,809	254/256JM	DJMP0154	257	1,809
15	1200	91.7	80.0	38.3	284/286JP	DJPP0156	375	2,640	284/286JM	DJMP0156	365	2,640
20	3600	91.7	90.0	45.4	254/256JP	DJPP0202	265	2,158	254/256JM	DJMP0202	250	2,158
20	1800	93.0	83.0	48.5	254/256JP	DJPP0204	275	2,252	254/256JM	DJMP0204	265	2,252
20	1200	92.4	81.5	49.7	284/286JP	DJPP0206	410	3,382	284/286JM	DJMP0206	405	3,382
25	3600	91.7	91.0	56.1	254/256JP	DJPP0252	300	2,630	254/256JM	DJMP0252	275	2,630
25	1800	93.6	85.0	58.8	284/286JP	DJPP0254	375	2,654	284/286JM	DJMP0254	365	2,654
30	3600	92.4	90.0	67.6	284/286JP	DJPP0302	370	2,986	284/286JM	DJMP0302	350	2,986
30	1800	94.1	86.0	69.4	284/286JP	DJPP0304	395	3,110	284/286JM	DJMP0304	370	3,110
40	3600	92.4	90.5	89.6	284/286JP	DJPP0402	395	3,899	284/286JM	DJMP0402	370	3,899

Note:

1. Data subject to change without notice.

ROLLED STEEL ODP JP/JM PREMIUM



ASGHJP/JM, NEMA PREMIUM, CLOSE COUPLED, (1 HP - 40 HP) [DJPP/DJMP - FP]

Effective: 01-01-2022
Supersedes: 07-06-2021

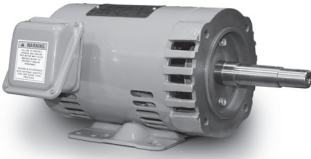

HP	RPM	FL EFF %	FL PF %	FL AMPS (230V)	DJPP				DJMP			
					FRAME	JP CATALOG NUMBER	APPROX. SHIPPING WT. (lbs.)	LIST PRICE (\$)	FRAME	JM CATALOG NUMBER	APPROX. SHIPPING WT. (lbs.)	LIST PRICE (\$)
1	1800	85.5	75.5	2.90	143/145JP	DJPP0014FP	40	636	143/145JM	DJMP0014FP	40	636
1	1200	82.5	66.0	3.44	143/145JP	DJPP0016FP	45	732	143/145JM	DJMP0016FP	45	732
1.5	3600	85.5	83.0	3.96	143/145JP	DJPP1/52FP	40	636	143/145JM	DJMP1/52FP	40	636
1.5	1800	86.5	80.5	4.03	143/145JP	DJPP1/54FP	47	644	143/145JM	DJMP1/54FP	47	644
1.5	1200	86.5	54.0	6.01	182/184JP	DJPP1/56FP	90	756	182/184JM	DJMP1/56FP	83	756
2	3600	86.5	85.0	5.09	143/145JP	DJPP0022FP	45	650	143/145JM	DJMP0022FP	45	650
2	1800	86.5	79.0	5.48	143/145JP	DJPP0024FP	50	650	143/145JM	DJMP0024FP	49	650
2	1200	87.5	57.0	7.51	182/184JP	DJPP0026FP	93	837	182/184JM	DJMP0026FP	89	837
3	3600	85.5	86.0	7.64	143/145JP	DJPP0032FP	50	824	143/145JM	DJMP0032FP	50	824
3	1800	89.5	73.0	8.60	182/184JP	DJPP0034FP	113	732	182/184JM	DJMP0034FP	95	732
3	1200	88.5	69.0	9.20	213/215JP	DJPP0036FP	155	1,171	213/215JM	DJMP0036FP	146	1,171
5	3600	87.5	88.0	12.2	182/184JP	DJPP0052FP	95	1,023	182/184JM	DJMP0052FP	78	1,023
5	1800	89.5	77.0	13.6	182/184JP	DJPP0054FP	113	865	182/184JM	DJMP0054FP	108	865
5	1200	89.5	73.0	14.3	213/215JP	DJPP0056FP	155	1,620	213/215JM	DJMP0056FP	146	1,620
7.5	3600	88.5	90.0	17.6	182/184JP	DJPP7/52FP	100	1,222	182/184JM	DJMP7/52FP	78	1,222
7.5	1800	91.0	81.0	19.1	213/215JP	DJPP7/54FP	155	1,240	213/215JM	DJMP7/54FP	140	1,240
7.5	1200	90.2	77.0	20.2	254/256JP	DJPP7/56FP	265	1,950	254/256JM	DJMP7/56FP	265	1,950
10	3600	90.2	85.5	24.3	213/215JP	DJPP0102FP	167	1,568	213/215JM	DJMP0102FP	165	1,568
10	1800	91.7	84.0	24.3	213/215JP	DJPP0104FP	180	1,382	213/215JM	DJMP0104FP	150	1,382
10	1200	91.7	79.5	25.7	254/256JP	DJPP0106FP	290	2,274	254/256JM	DJMP0106FP	275	2,274
15	3600	91.0	87.0	35.5	213/215JP	DJPP0152FP	167	2,070	213/215JM	DJMP0152FP	165	2,070
15	1800	93.0	83.0	36.4	254/256JP	DJPP0154FP	265	1,989	254/256JM	DJMP0154FP	257	1,989
15	1200	91.7	80.0	38.3	284/286JP	DJPP0156FP	375	2,904	284/286JM	DJMP0156FP	365	2,904
20	3600	91.7	90.0	45.4	254/256JP	DJPP0202FP	265	2,375	254/256JM	DJMP0202FP	250	2,375
20	1800	93.0	83.0	48.5	254/256JP	DJPP0204FP	275	2,476	254/256JM	DJMP0204FP	265	2,476
20	1200	92.4	81.5	49.7	284/286JP	DJPP0206FP	410	3,720	284/286JM	DJMP0206FP	405	3,720
25	3600	91.7	91.0	56.1	254/256JP	DJPP0252FP	300	2,893	254/256JM	DJMP0252FP	275	2,893
25	1800	93.6	85.0	58.8	284/286JP	DJPP0254FP	375	2,919	284/286JM	DJMP0254FP	365	2,919
30	3600	92.4	90.0	67.6	284/286JP	DJPP0302FP	370	3,284	284/286JM	DJMP0302FP	350	3,284
30	1800	94.1	86.0	69.4	284/286JP	DJPP0304FP	395	3,422	284/286JM	DJMP0304FP	370	3,422
40	3600	92.4	90.5	89.6	284/286JP	DJPP0402FP	395	4,482	284/286JM	DJMP0402FP	370	4,482

Note:

1. Data subject to change without notice.

ROLLED STEEL ODP AEGIS® SGR

ASGH, NEMA PREMIUM WITH AEGIS® SGR (1 HP - 40 HP) [DTP_G]



Effective: 01-01-2022
Supersedes: 07-06-2021

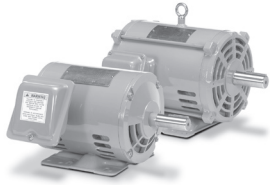

APPLICATIONS:

- Fans & Blowers
- Pumps
- Compressors
- HVAC Equipment

The AEGIS® SGR Bearing Protection Ring prevents electrical bearing "fluting" damage by safely diverting harmful shaft voltages and bearing currents to ground. Using proprietary Electron Transport Technology™, the conductive microfibers inside the AEGIS® SGR provide the most reliable current diversion technology for shaft grounding with a "path of least resistance" to dramatically extend motor life. **AEGIS® Shaft Grounding Rings have a warranty of 1 year.**

FEATURES:

- Output Range: 1 - 40 HP
- Speed: 3600, 1800 & 1200 RPM
- Enclosure: Open Drip Proof (IP22)
- Voltage: 230/460V (Usable on 200 & 208V)
- Three Phase, 60 Hz, 1.15 Service Factor (Continuous); 50 Hz, 1.0 Service Factor (Continuous)
- Grounding Ring Factory Installed Externally on DE Bracket
- Class F Insulation
- NEMA Design B Torques
- Rolled Steel Frame and Main Conduit Box
- Grounding Terminal Inside Main Conduit Box
- Oversized Main Conduit Box Rotatable in 90 Degree Increments - F1 Mounted Only (F2 not available)
- Designed for 40°C Ambient Temperature¹
- Designed for 3300 ft. Elevation²
- Bi-Directional Rotation
- 1045 Carbon Steel Shaft
- Aluminum Die Cast Squirrel Cage Rotor Construction
- Paint System: Phenolic Rust Proof Base Plus Polyurethane Top Coat
- Paint Color: Blue - Munsell 5PB 3/8
- Double Shielded Bearings Pre-Packed with MULTEMP SRL (Non-regreasable)
- Stainless Steel Nameplate
- Dual Column Design Nameplate as Standard (60/50 Hz)
- Suitable for Inverter Use per NEMA MG-1 Part 31.4.4.2^(3,4)
- Inverter Duty Speed Range: 20:1 Variable Torque, 10:1 Constant Torque
- 9 Leads for 5 HP and Smaller
- 12 Leads for 7.5 HP and Larger
- Motors are U.L. Recognized for United States and Canada, CSA Approved and CE Marked

EXTRAS/ OPTIONS:

Please refer to pages 147 - 152 for common modifications that can be performed.

Notes:

1. Consult a Stock Product Application Specialist for suitability in higher ambient environments.
2. Consult a Stock Product Application Specialist for suitability at higher elevations.
3. Motor service factor is 1.0 when operated on a VFD.
4. Precautions should be taken to eliminate or reduce shaft currents that may be imposed on the motor by the VFD as stated per NEMA MG-1. Part 31.
5. AEGIS® SGR Bearing Protection Ring can not be used in Hazardous Locations (e.g. Class I, Div. 2, etc.)

ROLLED STEEL ODP AEGIS® SGR



ASGH, NEMA PREMIUM WITH AEGIS® SGR [DTP_G]

Effective: 01-01-2022

Supersedes: 07-06-2021

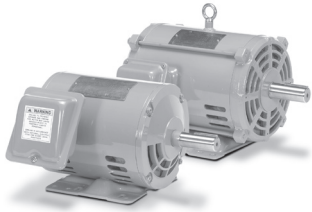

CATALOG NUMBER	HP	RPM	FRAME	FL EFF %	FL PF %	FL AMPS (230V)	APPROX. SHIPPING WT. (lbs.)	LIST PRICE (\$)
DTP0012G	1	3600	143/145T	80.0	85.5	2.74	34	565
DTP0014G	1	1800	143/145T	85.5	75.5	2.90	42	561
DTP0016G	1	1200	143/145T	82.5	66.0	3.44	43	710
DTP1/52G	1.5	3600	143/145T	85.5	83.0	3.96	34	597
DTP1/54G	1.5	1800	143/145T	86.5	80.5	4.03	47	610
DTP1/56G	1.5	1200	182/184T	86.5	54.0	6.01	94	839
DTP0022G	2	3600	143/145T	85.5	89.0	4.92	42	658
DTP0024G	2	1800	143/145T	86.5	79.0	5.48	47	645
DTP0026G	2	1200	182/184T	87.5	57.0	7.51	94	872
DTP0032G	3	3600	143/145T	85.5	86.0	7.64	42	732
DTP0034G	3	1800	182/184T	89.5	73.0	8.60	94	807
DTP0036G	3	1200	213/215T	88.5	69.0	9.20	158	1,214
DTP0052G	5	3600	182/184T	87.5	88.0	12.2	94	853
DTP0054G	5	1800	182/184T	89.5	77.0	13.6	94	889
DTP0056G	5	1200	213/215T	89.5	73.0	14.3	158	1,491
DTP7/52G	7.5	3600	184/182T	88.5	90.0	17.6	94	1,086
DTP7/54G	7.5	1800	213/215T	91.0	81.0	19.1	158	1,250
DTP7/56G	7.5	1200	254/256T	90.2	77.0	20.2	292	1,907
DTP0102G	10	3600	213/215T	90.2	85.5	24.3	158	1,353
DTP0104G	10	1800	213/215T	91.7	84.0	24.3	158	1,452
DTP0106G	10	1200	254/256T	91.7	79.5	25.7	292	2,133
DTP0152G	15	3600	213/215T	91.0	87.0	35.5	158	1,751
DTP0154G	15	1800	254/256T	93.0	83.0	36.4	230	1,920
DTP0156G	15	1200	284/286T	91.7	80.0	38.3	344	2,825
DTP0202G	20	3600	254/256T	91.7	90.0	45.4	292	2,202
DTP0204G	20	1800	254/256T	93.0	83.0	48.5	292	2,321
DTP0206G	20	1200	284/286T	92.4	81.5	49.4	344	3,389
DTP0252G	25	3600	254/256T	91.7	91.0	56.1	292	2,562
DTP0254G	25	1800	284/286T	93.6	85.0	58.8	344	2,842
DTP0302G	30	3600	284/286TS	92.4	90.0	67.6	344	3,116
DTP0304G	30	1800	284/286T	94.1	86.0	69.4	415	3,299
DTP0402G	40	3600	284/286TS	92.4	90.5	89.6	415	3,935

Notes:

1. AEGIS® SGR Rings have a warranty of 1 year.
2. Data subject to change without notice.

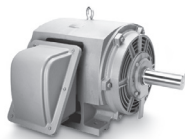

APPLICATIONS:

- Fans & Blowers
- Pumps
- HVAC Equipment
- Compressors
- Fire Pumps (See Option Below)



FIRE SAFETY

FEATURES:

- Output Range: 1 - 800 HP
- Speed: 3600, 1800 & 1200 RPM
- Enclosure: Open Drip Proof (IP22)
- Voltage: 230/460V (Usable on 208V); 150HP and Larger is 460V Only⁽¹⁾
- Three Phase, 60 Hz, 1.15 Service Factor (Continuous); 50 Hz, 1.0 Service Factor (Continuous)
- Class F Insulation
- Class B Temperature Rise
- NEMA Design B Torques
- Cast Iron Frame and End Brackets
- Rolled Steel Main Conduit Box
- Grounding Terminal Inside Main Conduit Box
- Oversized Main Conduit Box Rotatable in 90 Degree Increments - F1 Mounted
- Designed for 40°C Ambient Temperature²
- Designed for 3300 ft. Elevation³
- Bi-Directional Rotation
- 1045 Carbon Steel Shaft
- Aluminum Die Cast Squirrel Cage Rotor Construction
- Paint System: Phenolic Rust Proof Base Plus Polyurethane Top Coat
- Paint Color: Light Gray - Munsell N5.0
- Double Shielded Bearings Pre-Packed with MULTEMP SRL for F# 140T - 280T (Non-regreasable)
- High Quality Ball (or Roller) Bearings regreasable with Mobil Polyrex™ EM for F# 280TS and Larger
- Labyrinth Type Metal Flinger on Both Ends for F# 280TS and Larger
- Cast Iron Inner and Outer Bearing Caps for F#280TS and Larger
- Stainless Steel Nameplate
- New Dual Column Design Nameplate as Standard (60/50 Hz)
- Suitable for Inverter Use per NEMA MG-1 Part 31.4.4.2^(4,5)
- Inverter Duty Speed Range: 20:1 Variable Torque, 10:1 Constant Torque
- 9 Leads for 5 HP and Smaller
- 12 Leads for 7.5 HP to 125 HP
- 6 Leads for 150 HP and Larger
- Motors are U.L. Recognized, CSA Approved and CE Marked

EXTRAS/ OPTIONS:

Please refer to pages 147 - 152 for common modifications that can be performed.

Notes:

- * Fire Pump available. See product page for more details.
- 1. Available in 575V. TWMC carries minimal 575V stock; please check availability to ensure required motors are in stock.
Ratings may be available from our Canadian warehouses and/or our factory. Pricing and leadtime may vary.
- 2. Consult a Stock Product Application Specialist for suitability in higher ambient environments.
- 3. Consult a Stock Product Application Specialist for suitability at higher elevations.
- 4. Motor service factor is 1.0 when operated on a VFD.
- 5. Precautions should be taken to eliminate or reduce shaft currents that may be imposed on the motor by the VFD as stated per NEMA MG-1. Part 31.

CAST IRON ODP



ASHH, NEMA PREMIUM [DHP]*

Effective: 01-01-2022
Supersedes: 07-06-2021

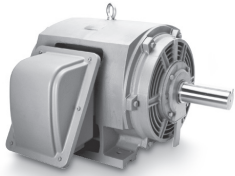

CATALOG NUMBER	HP	RPM	FRAME	FL EFF %	FL PF %	FL AMPS (460V or 575V)	APPROX. SHIPPING WT. (lbs.)	MOTOR LIST PRICE (\$)
DHP0014	1	1800	143T	85.5	78.0	1.41	54	466
DHP00145	1	1800	143T	85.5	78.0	1.13	54	466
DHP0016	1	1200	145T	82.5	65.5	1.74	75	603
DHP00165	1	1200	145T	82.5	65.5	1.39	75	603
DHP1/52	1.5	3600	143T	85.5	80.0	2.06	50	499
DHP1/525	1.5	3600	143T	85.5	80.0	1.65	50	499
DHP1/54	1.5	1800	145T	86.5	80.5	2.02	60	516
DHP1/545	1.5	1800	145T	86.5	80.5	1.62	60	516
DHP1/56	1.5	1200	182T	87.5	63.0	2.55	123	696
DHP1/565	1.5	1200	182T	87.5	63.0	2.04	123	696
DHP0022	2	3600	145T	85.5	84.5	2.59	57	563
DHP00225	2	3600	145T	85.5	84.5	2.07	57	563
DHP0024	2	1800	145T	86.5	79.5	2.72	58	586
DHP00245	2	1800	145T	86.5	79.5	2.18	58	586
DHP0026	2	1200	184T	87.5	71.0	3.01	130	734
DHP00265	2	1200	184T	87.5	71.0	2.40	130	734
DHP0032	3	3600	145T	87.5	87.0	3.69	66	627
DHP00325	3	3600	145T	87.5	87.0	2.95	66	627
DHP0034	3	1800	182T	89.5	81.0	3.88	117	603
DHP00345	3	1800	182T	89.5	81.0	3.10	117	603
DHP0036	3	1200	213T	88.5	77.0	4.12	183	976
DHP00365	3	1200	213T	88.5	77.0	3.30	183	976
DHP0052	5	3600	182T	87.5	91.0	5.90	120	712
DHP00525	5	3600	182T	87.5	91.0	4.72	120	712
DHP0054	5	1800	184T	89.5	84.5	6.19	145	756
DHP00545	5	1800	184T	89.5	84.5	4.95	145	756
DHP0056	5	1200	215T	89.5	79.0	6.62	195	1,177
DHP00565	5	1200	215T	89.5	79.0	5.30	195	1,177
DHP7/52	7.5	3600	184T	88.5	91.5	8.65	134	939
DHP7/525	7.5	3600	184T	88.5	91.5	6.92	134	939
DHP7/54	7.5	1800	213T	91.0	86.0	8.97	187	1,084
DHP7/545	7.5	1800	213T	91.0	86.0	7.18	187	1,084
DHP7/56	7.5	1200	254T	90.2	79.0	9.85	260	1,709
DHP7/565	7.5	1200	254T	90.2	79.0	7.88	260	1,709
DHP0102	10	3600	213T	90.2	88.0	11.8	190	1,177
DHP01025	10	3600	213T	90.2	88.0	14.75	190	1,177
DHP0104	10	1800	215T	91.7	87.0	11.7	215	1,283
DHP01045	10	1800	215T	91.7	87.0	9.36	215	1,283
DHP0106	10	1200	256T	91.7	81.0	12.6	329	1,953
DHP01065	10	1200	256T	91.7	81.0	10.08	329	1,953

CAST IRON ODP



ASHH, NEMA PREMIUM [DHP]*

Effective: 01-01-2022
Supersedes: 07-06-2021

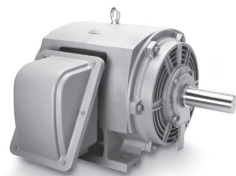

CATALOG NUMBER	HP	RPM	FRAME	FL EFF %	FL PF %	FL AMPS (460V or 575V)	APPROX. SHIPPING WT. (lbs.)	MOTOR LIST PRICE (\$)
DHP0152	15	3600	215T	90.2	87.5	17.8	220	1,576
DHP01525	15	3600	215T	90.2	87.5	14.2	220	1,576
DHP0154	15	1800	254T	93.0	84.5	17.9	247	1,721
DHP01545	15	1800	254T	93.0	84.5	14.3	247	1,721
DHP0156	15	1200	284T	91.7	83.0	18.5	367	2,611
DHP01565	15	1200	284T	91.7	83.0	14.8	367	2,611
DHP0202	20	3600	254T	91.0	90.5	22.8	233	1,995
DHP02025	20	3600	254T	91.0	90.5	18.2	233	1,995
DHP0204	20	1800	256T	93.0	86.5	23.3	350	2,127
DHP02045	20	1800	256T	93.0	86.5	18.6	350	2,127
DHP0206	20	1200	286T	92.4	83.5	24.3	392	3,165
DHP02065	20	1200	286T	92.4	83.5	19.4	392	3,165
DHP0252	25	3600	256T	91.7	92.0	27.7	317	2,370
DHP02525	25	3600	256T	91.7	92.0	22.1	317	2,370
DHP0254	25	1800	284T	93.6	87.0	28.7	352	2,627
DHP02545	25	1800	284T	93.6	87.0	23.0	352	2,627
DHP0256	25	1200	324T	93.0	83.0	30.3	640	3,926
DHP02565	25	1200	324T	93.0	83.0	24.2	640	3,926
DHP0302	30	3600	284TS	92.4	90.5	33.6	405	2,929
DHP03025	30	3600	284TS	92.4	90.5	26.9	405	2,929
DHP0304	30	1800	286T	94.1	87.0	34.3	429	3,087
DHP03045	30	1800	286T	94.1	87.0	27.4	429	3,087
DHP0306	30	1200	326T	93.6	83.5	35.9	568	4,410
DHP03065	30	1200	326T	93.6	83.5	28.7	568	4,410
DHP0402	40	3600	286TS	92.4	91.5	44.3	442	3,749
DHP04025	40	3600	286TS	92.4	91.5	35.4	442	3,749
DHP0404	40	1800	324T	94.1	86.0	46.3	608	3,828
DHP04045	40	1800	324T	94.1	86.0	37.0	608	3,828
DHP0406	40	1200	364T	94.1	87.0	45.7	835	5,504
DHP04065	40	1200	364T	94.1	87.0	36.6	835	5,504
DHP0502	50	3600	324TS	93.0	86.0	58.5	552	4,616
DHP05025	50	3600	324TS	93.0	86.0	46.8	552	4,616
DHP0504	50	1800	326T	94.5	85.0	58.3	629	4,290
DHP05045	50	1800	326T	94.5	85.0	46.6	629	4,290
DHP0506	50	1200	365T	94.1	86.0	57.8	766	6,521
DHP05065	50	1200	365T	94.1	86.0	46.2	766	6,521
DHP0602	60	3600	326TS	93.6	87.0	69.0	614	5,426
DHP06025	60	3600	326TS	93.6	87.0	55.2	614	5,426
DHP0604	60	1800	364T	95.0	85.0	69.6	735	5,443
DHP06045	60	1800	364T	95.0	85.0	55.6	735	5,443
DHP0606	60	1200	404T	94.5	85.5	69.5	1,100	7,812
DHP06065	60	1200	404T	94.5	85.5	55.6	1,100	7,812

CAST IRON ODP



ASHH, NEMA PREMIUM [DHP]*

Effective: 01-01-2022
Supersedes: 07-06-2021

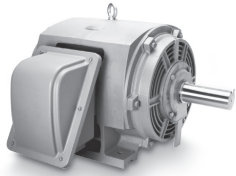

CATALOG NUMBER	HP	RPM	FRAME	FL EFF %	FL PF %	FL AMPS (460V or 575V)	APPROX. SHIPPING WT. (lbs.)	MOTOR LIST PRICE (\$)
DHP0752	75	3600	364TS	94.1	90.5	82.5	704	7,210
DHP0752S	75	3600	364TS	94.1	90.5	66.0	704	7,210
DHP0754	75	1800	365T	95.0	86.0	86.0	850	6,448
DHP0754S	75	1800	365T	95.0	86.0	68.8	850	6,448
DHP0754R	75	1800	365T	95.0	86.0	86.0	850	6,448
DHP07545R	75	1800	365T	95.0	86.0	68.8	850	6,448
DHP0756	75	1200	405T	94.5	86.5	86.0	1,210	9,393
DHP0756S	75	1200	405T	94.5	86.5	68.8	1,210	9,393
DHP0756R	75	1200	405T	94.5	86.5	86.0	1,210	9,393
DHP07565R	75	1200	405T	94.5	86.5	68.8	1,210	9,393
DHP1002	100	3600	365TS	94.1	90.5	110	761	9,563
DHP1002S	100	3600	365TS	94.1	90.5	88.0	761	9,563
DHP1004	100	1800	404T	95.4	85.5	115	961	8,272
DHP1004S	100	1800	404T	95.4	85.5	92.0	961	8,272
DHP1004R	100	1800	404T	95.4	85.5	115	961	8,272
DHP10045R	100	1800	404T	95.4	85.5	92.0	961	8,272
DHP1006	100	1200	444T	95.0	82.0	120	1,350	13,223
DHP1006S	100	1200	444T	95.0	82.0	96.0	1,350	13,223
DHP1006R	100	1200	444T	95.0	82.0	120	1,350	13,223
DHP10065R	100	1200	444T	95.0	82.0	96.0	1,350	13,223
DHP1252	125	3600	404TS	94.1	90.5	137	907	12,111
DHP1252S	125	3600	404TS	94.1	90.5	110	907	12,111
DHP1254	125	1800	405T	95.4	84.5	145	1,109	10,365
DHP1254S	125	1800	405T	95.4	84.5	116	1,109	10,365
DHP1254R	125	1800	405T	95.4	84.5	145	1,109	10,365
DHP12545R	125	1800	405T	95.4	84.5	116	1,109	10,365
DHP1256	125	1200	445T	95.0	82.0	150	1,605	15,475
DHP1256S	125	1200	445T	95.0	82.0	120	1,605	15,475
DHP1256R	125	1200	445T	95.0	82.0	150	1,605	15,475
DHP12565R	125	1200	445T	95.0	82.0	120	1,605	15,475
DHP1502	150	3600	405TS	94.5	90.5	164	1,003	14,669
DHP1502S	150	3600	405TS	94.5	90.5	131	1,003	14,669
DHP1504	150	1800	444T	95.8	86.0	170	1,540	13,425
DHP1504S	150	1800	444T	95.8	86.0	136	1,540	13,425
DHP1504R	150	1800	444T	95.8	86.0	170	1,540	13,425
DHP15045R	150	1800	444T	95.8	86.0	136	1,540	13,425
DHP1506	150	1200	445T	95.4	82.5	178	1,705	18,313
DHP1506S	150	1200	445T	95.4	82.5	142	1,705	18,313
DHP1506R	150	1200	445T	95.4	82.5	178	1,705	18,313
DHP15065R	150	1200	445T	95.4	82.5	142	1,705	18,313

CAST IRON ODP



ASHH, NEMA PREMIUM [DHP]*

Effective: 01-01-2022
Supersedes: 07-06-2021

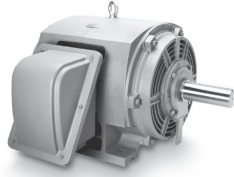

CATALOG NUMBER	HP	RPM	FRAME	FL EFF %	FL PF %	FL AMPS (460V or 575V)	APPROX. SHIPPING WT. (lbs.)	MOTOR LIST PRICE (\$)
DHP2002	200	3600	444TS	95.0	88.5	223	1,324	18,389
DHP20025	200	3600	444TS	95.0	88.5	178	1,324	18,389
DHP2004	200	1800	445T	95.8	86.5	226	1,577	16,434
DHP20045	200	1800	445T	95.8	86.5	181	1,577	16,434
DHP2006	200	1200	447T	95.4	83.0	236	2,010	24,375
DHP20065	200	1200	447T	95.4	83.0	189	2,010	24,375
DHP2006R	200	1200	447T	95.4	83.0	236	2,010	24,375
DHP20065R	200	1200	447T	95.4	83.0	189	2,010	24,375
DHP2502	250	3600	445TS	95.0	88.5	278	1,470	22,363
DHP25025	250	3600	445TS	95.0	88.5	222	1,470	22,363
DHP2504	250	1800	447T	95.8	87.0	281	1,806	23,265
DHP25045	250	1800	447T	95.8	87.0	225	1,806	23,265
DHP2504R	250	1800	447T	95.8	87.0	281	1,806	21,364
DHP25045R	250	1800	447T	95.8	87.0	225	1,806	23,265
DHP2506	250	1200	449T	95.8	83.0	296	2,420	30,470
DHP25065	250	1200	449T	95.8	83.0	237	2,420	30,470
DHP2506R	250	1200	449T	95.8	83.0	296	2,420	30,470
DHP25065R	250	1200	449T	95.8	83.0	237	2,420	30,470
DHP3002	300	3600	445TS	95.4	89.0	331	1,535	28,636
DHP30025	300	3600	445TS	95.4	89.0	265	1,535	28,636
DHP3004	300	1800	449T	95.8	87.5	335	2,140	28,462
DHP30045	300	1800	449T	95.8	87.5	268	2,140	28,462
DHP3006	300	1200	449T	95.4	87.0	338	2,615	36,564
DHP30065	300	1200	449T	95.4	87.0	338	2,615	36,564
DHP3502	350	3600	447TS	95.4	90.0	382	1,840	32,168
DHP35025	350	3600	447TS	95.4	90.0	306	1,840	32,168
DHP3504	350	1800	449T	95.8	87.5	391	2,310	33,211
DHP35045	350	1800	449T	95.8	87.5	313	2,310	33,211
DHP3506	350	1200	5009B	95.4	85.0	404	3,715	68,539
DHP35065	350	1200	5009B	95.4	85.0	323	3,715	68,539
DHP4002	400	3600	449TS	95.8	90.0	434	2,037	36,715
DHP40025	400	3600	449TS	95.8	90.0	347	2,037	36,715
DHP4004	400	1800	449T	95.8	87.7	446	2,445	37,954
DHP40045	400	1800	449T	95.8	87.7	357	2,445	37,954
DHP4006	400	1200	5009B	95.8	84.5	463	3,835	70,462
DHP40065	400	1200	5009B	95.8	84.5	370	3,835	70,462
DHP4502	450	3600	449TS	95.8	90.5	486	2,125	42,217
DHP45025	450	3600	449TS	95.8	90.5	389	2,125	42,217
DHP4504	450	1800	5009B	96.2	88.0	498	3,620	64,884
DHP45045	450	1800	5009B	96.2	88.0	398	3,620	64,884
DHP4506	450	1200	5009B	96.2	84.0	521	3,960	80,252
DHP45065	450	1200	5009B	96.2	84.0	416	3,960	80,252

CAST IRON ODP



ASHH, NEMA PREMIUM [DHP]*

Effective: 01-01-2022
Supersedes: 07-06-2021

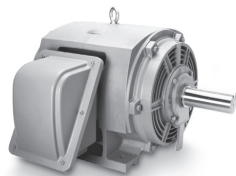

CATALOG NUMBER	HP	RPM	FRAME	FL EFF %	FL PF %	FL AMPS (460V or 575V)	APPROX. SHIPPING WT. (lbs.)	MOTOR LIST PRICE (\$)
DHP5002	500	3600	449TS	95.8	91.2	417	2,225	47,968
DHP50025	500	3600	449TS	95.8	91.2	334	2,225	47,968
DHP5004	500	1800	5009B	96.2	88.0	553	3,790	70,073
DHP50045	500	1800	5009B	96.2	88.0	426	3,790	71,824
DHP5006	500	1200	5009B	96.2	84.0	579	4,075	83,972
DHP50065	500	1200	5009B	96.2	84.0	463	4,075	83,972
DHP6002	600	3600	5011A	95.0	87.5	676	3,240	77,281
DHP60025	600	3600	5011A	95.0	87.5	541	3,240	77,281
DHP6004	600	1800	5011B	96.2	87.8	665	3,650	80,778
DHP60045	600	1800	5011B	96.2	87.8	532	3,650	80,778
DHP6006	600	1200	5011B	95.8	82.6	710	4,250	84,895
DHP60065	600	1200	5011B	95.8	82.6	568	4,250	84,895
DHP6006R	600	1200	5011C	95.8	82.6	710	4,250	84,895
DHP60065R	600	1200	5011C	95.8	82.6	568	4,250	84,895
DHP7002	700	3600	5011/5012A	95.0	88.3	781	3,610	89,409
DHP70025	700	3600	5011/5012A	95.0	88.3	625	3,610	89,409
DHP7004	700	1800	5011B	96.2	86.0	792	3,870	84,322
DHP70045	700	1800	5011B	96.2	86.0	634	3,870	84,322
DHP7006	700	1200	5810B	95.8	82.6	828	6,450	95,920
DHP70065	700	1200	5810B	95.8	82.6	662	6,450	95,920
DHP8002	800	3600	5011/5012A	95.0	87.9	897	3,610	93,931
DHP80025	800	3600	5011/5012A	95.0	87.9	718	3,610	93,931
DHP8004	800	1800	5011/5012B	96.2	86.2	903	4,210	90,338
DHP80045	800	1800	5011/5012B	96.2	86.2	722	4,210	90,338
DHP8004R	800	1800	5011/5012C	96.2	86.2	903	4,210	90,338
DHP80045R	800	1800	5011/5012C	96.2	86.2	722	4,210	90,338
DHP8006	800	1200	5810B	95.8	82.5	948	6,820	108,932
DHP80065	800	1200	5810B	95.8	82.5	758	6,820	108,932
DHP8006R	800	1200	5810C	95.8	82.5	948	6,820	108,932
DHP80065R	800	1200	5810C	95.8	82.5	758	6,820	108,932

Notes:

1. Delivery for Fire Pump Duty motor (Catalog Number + FP) is standard 5 - 10 working days after receipt of order if standard motor is in stock; Painting to Fire Safety Red requirement on Fire Pump Duty type motor can be waived in order to expedite delivery upon request.
2. Fire Pump Duty Motor pricing includes: adding UL nameplate, restamping original nameplate to new "DHP_FP" catalog number,
3. To order 575V, add "5" to the end of Catalog Number, for example: "DHP00545" for 5 HP, 1800 RPM, 575V.
4. "R" = Motor stocked standard with a Drive-End Roller Bearing.
5. Ratings 150 HP and larger are 460V only.
6. Data subject to change without notice.

CAST IRON ODP



ASHH, NEMA PREMIUM (1 HP - 500 HP) [DHP_FP]*

Effective: 01-01-2022
Supersedes: 07-06-2021

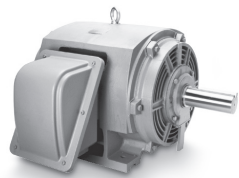

FIRE PUMP CATALOG NUMBER	HP	RPM	FRAME	FL EFF %	FL PF %	FL AMPS (460V)	APPROX. SHIPPING WT. (lbs.)	FIRE PUMP LIST PRICE (\$)
DHP0014FP	1	1800	143T	85.5	78.0	1.41	54	514
DHP0016FP	1	1200	145T	82.5	65.5	1.74	75	663
DHP1/52FP	1.5	3600	143T	85.5	80.0	2.06	50	548
DHP1/54FP	1.5	1800	145T	86.5	80.5	2.02	60	570
DHP1/56FP	1.5	1200	182T	87.5	63.0	2.55	123	767
DHP0022FP	2	3600	145T	85.5	84.5	2.59	57	620
DHP0024FP	2	1800	145T	86.5	79.5	2.72	58	626
DHP0026FP	2	1200	184T	87.5	71.0	3.01	130	808
DHP0032FP	3	3600	145T	87.5	87.0	3.69	66	690
DHP0034FP	3	1800	182T	89.5	81.0	3.88	117	663
DHP0036FP	3	1200	213T	88.5	77.0	4.12	183	1,073
DHP0052FP	5	3600	182T	87.5	91.0	5.90	120	784
DHP0054FP	5	1800	184T	89.5	84.5	6.19	145	831
DHP0056FP	5	1200	215T	89.5	79.0	6.62	195	1,295
DHP7/52FP	7.5	3600	184T	88.5	91.5	8.65	134	1,032
DHP7/54FP	7.5	1800	213T	91.0	86.0	8.97	187	1,191
DHP7/56FP	7.5	1200	254T	90.2	79.0	9.85	260	1,880
DHP0102FP	10	3600	213T	90.2	88.0	11.8	190	1,295
DHP0104FP	10	1800	215T	91.7	87.0	11.7	215	1,411
DHP0106FP	10	1200	256T	91.7	81.0	12.6	329	2,149
DHP0152FP	15	3600	215T	90.2	87.5	17.8	220	1,735
DHP0154FP	15	1800	254T	93.0	84.5	17.9	247	1,893
DHP0156FP	15	1200	284T	91.7	83.0	18.5	367	2,873
DHP0202FP	20	3600	254T	91.0	90.5	22.8	233	2,195
DHP0204FP	20	1800	256T	93.0	86.5	23.3	350	2,339
DHP0206FP	20	1200	286T	92.4	83.5	24.3	392	3,482
DHP0252FP	25	3600	256T	91.7	92.0	27.7	317	2,607
DHP0254FP	25	1800	284T	93.6	87.0	28.7	352	2,890
DHP0256FP	25	1200	324T	93.0	83.0	30.3	640	4,319
DHP0302FP	30	3600	284TS	92.4	90.5	33.6	405	3,222
DHP0304FP	30	1800	286T	94.1	87.0	34.3	429	3,396
DHP0306FP	30	1200	326T	93.6	83.5	35.9	568	4,851
DHP0402FP	40	3600	286TS	92.4	91.5	44.3	442	4,123
DHP0404FP	40	1800	324T	94.1	86.0	46.3	608	4,210
DHP0406FP	40	1200	364T	94.1	87.0	45.7	835	6,055
DHP0502FP	50	3600	324TS	93.0	86.0	58.5	552	5,078
DHP0504FP	50	1800	326T	94.5	85.0	58.3	629	4,720
DHP0506FP	50	1200	365T	94.1	86.0	57.8	766	7,174
DHP0602FP	60	3600	326TS	93.6	87.0	69.0	614	5,969
DHP0604FP	60	1800	364T	95.0	85.0	69.6	735	5,986
DHP0606FP	60	1200	404T	94.5	85.5	69.5	1,100	8,619
DHP0752FP	75	3600	364TS	94.1	90.5	82.5	704	7,930
DHP0754FP	75	1800	365T	95.0	86.0	86.0	850	7,094
DHP0754RFP	75	1800	365T	95.0	86.0	86.0	850	7,094
DHP0756FP	75	1200	405T	94.5	86.5	86.0	1,210	10,331
DHP0756RFP	75	1200	405T	94.5	86.5	86.0	1,210	10,331

CAST IRON ODP



ASHH, NEMA PREMIUM [DHP_FP]*

Effective: 01-01-2022
Supersedes: 07-06-2021

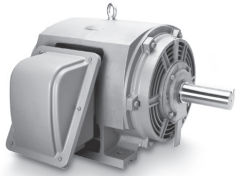

FIRE PUMP CATALOG NO.	HP	RPM	FRAME	FL EFF %	FL PF %	FL AMPS (460V)	APPROX. SHIPPING WT. (lbs.)	FIRE PUMP LIST PRICE (\$)
DHP1002FP	100	3600	365TS	94.1	90.5	110	761	10,224
DHP1004FP	100	1800	404T	95.4	85.5	115	961	8,845
DHP1004RFP	100	1800	404T	95.4	85.5	115	961	8,845
DHP1006FP	100	1200	444T	95.0	82.0	120	1,350	14,609
DHP1006RFP	100	1200	444T	95.0	82.0	120	1,350	14,609
DHP1252FP	125	3600	404TS	94.1	90.5	137	907	12,950
DHP1254FP	125	1800	405T	95.4	84.5	145	1,109	11,082
DHP1254RFP	125	1800	405T	95.4	84.5	145	1,109	11,082
DHP1256FP	125	1200	445T	95.0	82.0	150	1,605	17,095
DHP1256RFP	125	1200	445T	95.0	82.0	150	1,605	17,095
DHP1502FP	150	3600	405TS	94.5	90.5	164	1,003	15,686
DHP1504FP	150	1800	444T	95.8	86.0	170	1,540	14,832
DHP1504RFP	150	1800	444T	95.8	86.0	170	1,540	14,832
DHP1506FP	150	1200	445T	95.4	82.5	178	1,705	20,231
DHP1506RFP	150	1200	445T	95.4	82.5	178	1,705	20,231
DHP2002FP	200	3600	444TS	95.0	88.5	223	1,324	20,314
DHP2004FP	200	1800	445T	95.8	86.5	226	1,577	18,155
DHP2006FP	200	1200	447T	95.4	83.0	236	2,010	26,929
DHP2006RFP	200	1200	447T	95.4	83.0	236	2,010	26,929
DHP2502FP	250	3600	445TS	95.0	88.5	278	1,470	24,704
DHP2504FP	250	1800	447T	95.8	87.0	281	1,806	25,703
DHP2504RFP	250	1800	447T	95.8	87.0	281	1,806	25,703
DHP2506FP	250	1200	449T	95.4	83.0	296	2,420	33,661
DHP2506RFP	250	1200	449T	95.4	83.0	296	2,420	33,661
DHP3002FP	300	3600	445TS	95.4	89.0	331	1,320	31,634
DHP3004FP	300	1800	449T	95.8	87.5	335	2,140	31,434
DHP3006FP	300	1200	449T	95.4	87.0	338	2,615	40,394
DHP3502FP	350	3600	447TS	95.4	90.0	382	1,590	35,537
DHP3504FP	350	1800	449T	95.8	87.5	391	2,310	36,689
DHP4002FP	400	3600	449TS	95.8	90.0	434	2,055	40,561
DHP4004FP	400	1800	449T	95.8	87.7	446	2,445	41,931
DHP4502FP	450	3600	449TS	95.8	90.5	486	2,125	46,639
DHP5002FP	500	3600	449TS	95.8	91.2	536	2,225	51,478

Notes:

- * Fire Pump available as made to order. Fire Pump Certificate complies with ANSI/UL 1004-5. Certificate# 20120717 – EX6569.
- 1. Delivery for Fire Pump Duty motor (Catalog Number + FP) is standard 5 - 10 working days after receipt of order if standard motor is in stock;
- 2. Fire Pump Duty Motor pricing includes: adding UL nameplate, restamping original nameplate to new "DHP_FP" catalog number.
- 3. To order 575V, add "5" to the end of Catalog Number, for example: "DHP00545" for 5 HP, 1800 RPM, 575V.
- 4. "R" = Motor stocked standard with a Drive-End Roller Bearing.
- 5. Ratings 150 HP and larger are 460V only.
- 6. Data subject to change without notice.

CAST IRON ODP AEGIS® SGR



ASHH, NEMA PREMIUM WITH AEGIS® SGR (1 HP - 75 HP) [DHP_G]

Effective: 01-01-2022
Supersedes: 07-06-2021

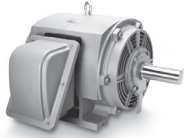

APPLICATIONS:

- Fans & Blowers
- Pumps
- Compressors
- HVAC Equipment

The AEGIS® SGR Bearing Protection Ring prevents electrical bearing "fluting" damage by safely diverting harmful shaft voltages and bearing currents to ground. Using proprietary Electron Transport Technology™, the conductive microfibers inside the AEGIS® SGR provide the most reliable current diversion technology for shaft grounding with a "path of least resistance" to dramatically extend motor life.

AEGIS® Shaft Grounding Rings have a warranty of 1 year.

FEATURES:

- Output Range: 1 - 75 HP
- Speed: 3600, 1800 & 1200 RPM
- Enclosure: Open Drip Proof (IP22)
- Voltage: 230/460V (Usable on 208V); 150HP and Larger is 460V Only¹
- Three Phase, 60 Hz, 1.15 Service Factor (Continuous); 50 Hz, 1.0 Service Factor (Continuous)
- Grounding Ring Factory Installed Externally on DE Bracket for F# 143T - 286T; Internally on NDE for F# 284TS - 405T
- Class F Insulation
- Class B Temperature Rise
- NEMA Design B Torques
- Cast Iron Frame and End Brackets
- Rolled Steel Main Conduit Box
- Grounding Terminal Inside Main Conduit Box
- Rolled Steel Oversized Main Conduit Box Rotatable in 90 Degree Increments - F1 Mounted
- Designed for 40°C Ambient Temperature²
- Designed for 3300 ft. Elevation³
- Bi-Directional Rotation
- 1045 Carbon Steel Shaft
- Aluminum Die Cast Squirrel Cage Rotor Construction
- Paint System: Phenolic Rust Proof Base Plus Polyurethane Top Coat
- Paint Color: Light Gray - Munsell N5.0
- Double Shielded Bearings Pre-Packed with MULTEMP SRL for F# 140T - 280T (Non-regreasable)
- High Quality Ball (or Roller) Bearings regreasable with Mobil Polyrex™ EM for F# 280TS and Larger
- Metal Flinger on Both Ends for F# 280TS and Larger
- Cast Iron Inner and Outer Bearing Caps for F#280TS and Larger
- Stainless Steel Nameplate
- Dual Column Design Nameplate as Standard (60/50 Hz)
- Suitable for Inverter Use per NEMA MG-1 Part 31.4.4.2 ^(4,5)
- Inverter Duty Speed Range: 20:1 Variable Torque, 10:1 Constant Torque
- 9 Leads for 5 HP and Smaller
- 12 Leads for 7.5 HP to 125 HP
- 6 Leads for 150 HP and Larger
- Motors are U.L. Recognized, CSA Approved and CE Marked

EXTRAS/ OPTIONS:

Please refer to pages 147 - 152 for common modifications that can be performed.

Notes:

1. Available in 575V. TWMC carries minimal 575V stock; please check availability to ensure required motors are in stock. Ratings may be available from our Canadian warehouses and/or our factory. Pricing and leadtime may vary.
2. Consult a Stock Product Application Specialist for suitability in higher ambient environments.
3. Consult a Stock Product Application Specialist for suitability at higher elevations.
4. Motor service factor is 1.0 when operated on a VFD.
5. Precautions should be taken to eliminate or reduce shaft currents that may be imposed on the motor by the VFD as stated per NEMA MG-1, Part 31.
6. AEGIS® SGR Bearing Protection Ring can not be used in Hazardous Locations (e.g. Class I, Div. 2, etc.)

CAST IRON ODP AEGIS® SGR



ASHH, NEMA PREMIUM WITH AEGIS® SGR [DHP_G]

Effective: 01-01-2022
Supersedes: 07-06-2021

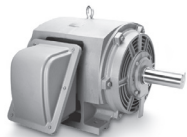

CATALOG NUMBER	HP	RPM	FRAME	FL EFF %	FL PF %	FL AMPS (460V)	APPROX. SHIPPING WT. (lbs.)	LIST PRICE (\$)
DHP0014G	1	1800	143T	85.5	78.0	1.41	54	595
DHP0016G	1	1200	145T	82.5	65.5	1.74	75	748
DHP1/52G	1.5	3600	143T	85.5	80.0	2.06	50	631
DHP1/54G	1.5	1800	145T	86.5	80.5	2.02	60	653
DHP1/56G	1.5	1200	182T	87.5	63.0	2.55	123	993
DHP0022G	2	3600	145T	85.5	84.5	2.59	57	705
DHP0024G	2	1800	145T	86.5	79.5	2.72	58	770
DHP0026G	2	1200	184T	87.5	71.0	3.01	130	1,047
DHP0032G	3	3600	145T	87.5	87.0	3.69	66	773
DHP0034G	3	1800	182T	89.5	81.0	3.88	117	811
DHP0036G	3	1200	213T	88.5	77.0	4.12	183	1,339
DHP0052G	5	3600	182T	87.5	91.0	5.90	120	935
DHP0054G	5	1800	184T	89.5	84.5	6.19	145	970
DHP0056G	5	1200	215T	89.5	79.0	6.62	195	1,558
DHP7/52G	7.5	3600	184T	88.5	91.5	8.65	134	1,151
DHP7/54G	7.5	1800	213T	91.0	86.0	8.97	187	1,433
DHP7/56G	7.5	1200	254T	90.2	79.0	9.85	260	2,021
DHP0102G	10	3600	213T	90.2	88.0	11.8	190	1,442
DHP0104G	10	1800	215T	91.7	87.0	11.7	215	1,540
DHP0106G	10	1200	256T	91.7	81.0	12.6	329	2,275
DHP0152G	15	3600	215T	90.2	87.5	17.8	220	1,867
DHP0154G	15	1800	254T	93.0	84.5	17.9	247	2,033
DHP0156G	15	1200	284T	91.7	83.0	18.5	367	3,011
DHP0202G	20	3600	254T	91.0	90.5	22.8	233	2,344
DHP0204G	20	1800	256T	93.0	86.5	23.3	350	2,474
DHP0206G	20	1200	286T	92.4	83.5	24.3	392	3,607
DHP0252G	25	3600	256T	91.7	92.0	27.7	317	2,734
DHP0254G	25	1800	284T	93.6	87.0	28.7	352	3,030
DHP0256G	25	1200	324T	93.0	83.0	30.3	640	4,447
DHP0302G	30	3600	284TS	92.4	90.5	33.6	405	3,327
DHP0304G	30	1800	286T	94.1	87.0	34.3	429	3,516
DHP0306G	30	1200	326T	93.6	83.5	35.9	568	4,965
DHP0402G	40	3600	286TS	92.4	91.5	44.3	442	4,208
DHP0404G	40	1800	324T	94.1	86.0	46.3	608	4,339
DHP0406G	40	1200	364T	94.1	87.0	45.7	835	6,156
DHP0502G	50	3600	324TS	93.0	86.0	58.5	552	5,160
DHP0504G	50	1800	326T	94.5	85.0	58.3	629	4,833
DHP0506G	50	1200	365T	94.1	86.0	57.8	766	7,230
DHP0602G	60	3600	326TS	93.6	87.0	69.0	614	6,035
DHP0604G	60	1800	364T	95.0	85.0	69.6	735	6,088
DHP0606G	60	1200	404T	94.5	85.5	69.5	1,100	8,699
DHP0752G	75	3600	364TS	94.1	90.5	82.5	704	7,929
DHP0754G	75	1800	365T	95.0	86.0	86.0	850	7,146
DHP0756G	75	1200	405T	94.5	86.5	86.0	1,210	10,310

Notes:

- 1. Ratings larger than 75 HP with SGR can be quoted and provided upon request.
- 1. All data subject to change without notice.

ROLLED STEEL TEFC FAMILY



AEGHPE, NEMA PREMIUM, F#56 (1/4 HP - 2 HP) [GH]

Effective: 01-01-2022

AEGH, NEMA PREMIUM, F#140T - 210T (1 HP - 10 HP) [GP]

Supersedes: 07-06-2021

AEGHPE-CF, NEMA PREMIUM, FOOTED C-FACE, F#56 (1/4 HP - 2 HP) [GH_C]

AETHPE, NEMA PREMIUM, ROUND BODY C-FACE, F#56 (1/4 HP - 2 HP) [GHV_C]

AEGHCF, NEMA PREMIUM, FOOTED C-FACE, F#140T - 210T (1 HP - 10 HP) [GP_C]

AETHCF, NEMA PREMIUM, ROUND BODY C-FACE, F#140T - 210T (1 HP - 10 HP) [GPV_C]



APPLICATIONS:

- Fans & Blowers
- Compressors
- Pumps
- HVAC Equipment

FEATURES:

- Output Range: 1/4 - 10 HP
- Speed: 3600, 1800, 1200 RPM
- Enclosure: Totally Enclosed Fan Cooled (IP44)
- Voltage: 230/460V (Usable on 200 & 208V)
- Three Phase, 60 Hz, 1.15 Service Factor (Continuous); 50 Hz, 1.0 Service Factor (Continuous)
- Class F Insulation
- Class B Temperature Rise
- NEMA Design B Torques
- Rolled Steel Frame, Fan Cover, and Main Conduit Box
- Grounding Terminal Inside Main Conduit Box
- Oversized Main Conduit Box Rotatable in 90 Degree Increments - F1 Mounted Only (F2 not available)
- Designed for 40°C Ambient Temperature¹
- Designed for 3300 ft. Elevation²
- Bi-Directional Rotation
- Cast Iron End Brackets
- 1045 Carbon Steel Shaft
- Aluminum Die Cast Squirrel Cage Rotor Construction
- Paint System: Phenolic Rust Proof Base Plus Polyurethane Top Coat
- Paint Color: Blue - Munsell 5PB 3/8
- Double Shielded Bearings Pre-Packed with MULTEMP SRL (Non-regreasable)
- Stainless Steel Nameplate
- Dual Column Design Nameplate as Standard (60/50 Hz)
- Suitable for Inverter Use per NEMA MG-1 Part 31.4.4.2^(3,4)
- Inverter Duty Speed Range: 20:1 Variable Torque, 10:1 Constant Torque
- 9 Leads for 5 HP and Smaller
- 12 Leads for 7.5 HP and Larger
- Motors are U.L. Recognized for United States and Canada, CSA Approved and CE Marked

EXTRAS/ OPTIONS:

Please refer to pages 147 - 152 for common modifications that can be performed.

Notes:

1. Consult a Stock Product Application Specialist for suitability in higher ambient environments.
2. Consult a Stock Product Application Specialist for suitability at higher elevations.
3. Motor service factor is 1.0 when operated on a VFD.
4. Precautions should be taken to eliminate or reduce shaft currents that may be imposed on the motor by the VFD as stated per NEMA MG-1, Part 31

ROLLED STEEL TEFC PREMIUM



AEGHPE, NEMA PREMIUM, F#56 (1/4 HP - 2 HP) [GH]

Effective: 01-01-2022

AEGH, NEMA PREMIUM, F#140T - 210T (1 HP - 10 HP) [GP]

Supersedes: 07-06-2021



CATALOG NUMBER	HP	RPM	FRAME	FL EFF %	FL PF %	FL AMPS (230V)	APPROX. SHIPPING WT. (lbs.)	LIST PRICE (\$)
GH0/22	1/4	3600	56	72.0	82.0	0.79	25	419
GH0/24	1/4	1800	56	72.0	73.0	0.89	27	406
GH0/26	1/4	1200	56	72.0	71.5	0.91	31	556
GH0/32	1/3	3600	56	72.0	80.5	1.08	25	432
GH0/34	1/3	1800	56	75.5	74.5	1.11	27	419
GH0/36	1/3	1200	56	72.0	61.0	1.42	31	570
GH0/52	1/2	3600	56	74.0	81.5	1.55	26	441
GH0/54	1/2	1800	56	78.5	81.0	1.47	30	443
GH0/56	1/2	1200	56	75.5	63.0	1.97	37	599
GH0/72	3/4	3600	56	77.0	80.0	2.28	28	465
GH0/74	3/4	1800	56	81.5	77.5	2.22	30	453
GH0/76	3/4	1200	56	78.5	67.5	2.55	38	623
GH0012	1	3600	56	80.0	79.5	3.06	31	476
GP0012	1	3600	143/145T	80.0	85.5	2.74	33	501
GH0014	1	1800	56	85.5	75.5	2.90	41	469
GP0014	1	1800	143/145T	85.5	75.5	2.90	41	490
GH0016	1	1200	56	82.5	66.0	3.44	45	628
GP0016	1	1200	143/145T	82.5	66.0	3.44	43	644
GH1/52	1.5	3600	56	85.5	83.0	3.96	35	547
GP1/52	1.5	3600	143/145T	85.5	83.0	3.96	33	575
GH1/54	1.5	1800	56	86.5	80.5	4.03	44	578
GP1/54	1.5	1800	143/145T	86.5	80.5	4.03	46	549
GP1/56	1.5	1200	182/184T	87.5	55.0	5.84	75	647
GH0022	2	3600	56	86.5	85.0	5.09	42	608
GP0022	2	3600	143/145T	86.5	85.0	5.09	41	608
GH0024	2	1800	56	86.5	79.0	5.48	46	615
GP0024	2	1800	143/145T	86.5	79.0	5.48	46	585
GP0026	2	1200	182/184T	88.5	64.5	6.56	97	729
GH0032	3	3600	56	86.5	89.0	7.30	35	677
GP0032	3	3600	182/184T	87.5	87.5	7.34	84	714
GP0034	3	1800	182/184T	89.5	74.0	8.48	69	711
GP0036	3	1200	213/215T	89.5	68.0	9.23	145	955
GP0052	5	3600	182/184T	89.5	90.0	11.6	97	840
GP0054	5	1800	182/184T	89.5	80.0	13.1	94	764
GP0056	5	1200	213/215T	90.2	73.5	14.1	189	1,369
GP7/52	7.5	3600	213/215T	90.2	84.5	18.4	141	1,244
GP7/54	7.5	1800	213/215T	91.7	83.0	18.5	135	1,167
GP0102	10	3600	213/215T	91.0	86.0	23.9	186	1,316
GP0104	10	1800	213/215T	91.7	85.0	24.0	183	1,369

Notes:

1. All data subject to change without notice.

ROLLED STEEL TEFC PREMIUM C-FACE



AEGHPE-CF, NEMA PREMIUM, FOOTED C-FACE, F#56 (1/4 HP - 2 HP) [GH_C]

Effective: 01-01-2022
Supersedes: 07-06-2021

AETHPE, NEMA PREMIUM, ROUND BODY C-FACE, F#56 (1/4 HP - 2 HP) [GHV_C]

AEGHCF, NEMA PREMIUM, FOOTED C-FACE, F#140T - 210T (1 HP - 10 HP) [GP_C]

AETHCF, NEMA PREMIUM, ROUND BODY C-FACE, F#140T - 210T (1 HP - 10 HP) [GPV_C]



HP	RPM	FL EFF %	FL PF %	FL AMPS (230V)	FRAME	FOOTED C-FACE			ROUND BODY C-FACE		
						CATALOG NUMBER	APPROX. SHIPPING WT. (lbs.)	LIST PRICE (\$)	CATALOG NUMBER	APPROX. SHIPPING WT. (lbs.)	LIST PRICE (\$)
1/4	3600	72.0	82.0	0.79	56C	GH0/22C	25	379	GHV0/22C	24	379
1/4	1800	72.0	73.0	0.89	56C	GH0/24C	27	353	GHV0/24C	26	353
1/4	1200	72.0	71.5	0.91	56C	GH0/26C	30	450	GHV0/26C	29	450
1/3	3600	72.0	80.5	1.08	56C	GH0/32C	30	405	GHV0/32C	29	405
1/3	1800	75.5	74.5	1.11	56C	GH0/34C	32	370	GHV0/34C	31	370
1/3	1200	72.0	61.0	1.42	56C	GH0/36C	36	466	GHV0/36C	35	466
1/2	3600	74.0	81.5	1.55	56C	GH0/52C	31	411	GHV0/52C	30	411
1/2	1800	78.5	81.0	1.47	56C	GH0/54C	35	440	GHV0/54C	34	440
1/2	1200	75.5	63.0	1.97	56C	GH0/56C	42	481	GHV0/56C	41	481
3/4	3600	77.0	80.0	2.28	56C	GH0/72C	33	416	GHV0/72C	32	416
3/4	1800	81.5	77.5	2.22	56C	GH0/74C	35	455	GHV0/74C	34	455
3/4	1200	81.7	67.5	2.55	56C	GH0/76C	42	524	GHV0/76C	41	524
1	3600	77.0	79.5	3.06	56C	GH0012C	35	483	GHV0012C	34	483
1	3600	80.0	85.5	2.74	143/145TC	GP0012C	35	528	GPV0012C	34	528
1	1800	85.5	75.5	2.90	56C	GH0014C	45	486	GHV0014C	44	486
1	1800	85.5	75.5	2.90	143/145TC	GP0014C	45	577	GPV0014C	44	577
1	1200	82.5	66.0	3.44	56C	GH0016C	42	551	GHV0016C	41	551
1	1200	82.5	66.0	3.44	143/145TC	GP0016C	42	578	GPV0016C	41	578
1.5	3600	85.5	83.0	3.96	56C	GH1/52C	39	527	GHV1/52C	38	527
1.5	3600	85.5	83.0	3.96	143/145TC	GP1/52C	39	608	GPV1/52C	38	608
1.5	1800	86.5	80.5	4.03	56C	GH1/54C	48	546	GHV1/54C	47	510
1.5	1800	86.5	80.5	4.03	143/145TC	GP1/54C	48	627	GPV1/54C	47	627
1.5	1200	87.5	55.0	5.84	182/184TC	GP1/56C	75	764	GPV1/56C	74	764
2	3600	86.5	85.0	5.09	56C	GH0022C	46	539	GHV0022C	45	539
2	3600	86.5	85.0	5.09	143/145TC	GP0022C	46	641	GPV0022C	45	641
2	1800	86.5	79.0	5.48	56C	GH0024C	49	566	GHV0024C	48	566
2	1800	86.5	79.0	5.48	143/145TC	GP0024C	49	650	GPV0024C	48	650
2	1200	88.5	64.5	6.56	182/184TC	GP0026C	132	1,072	GPV0026C	97	1,072
3	3600	86.5	89.0	7.30	56C	GH0032C	35	616	GHV0032C	35	616
3	3600	87.5	87.5	7.34	182/184TC	GP0032C	130	833	GPV0032C	84	833
3	1800	89.5	74.0	8.48	182/184TC	GP0034C	135	950	GPV0034C	69	950
3	1200	89.5	68.0	9.23	213/215TC	GP0036C	164	1,706	GPV0036C	145	1,706
5	3600	89.5	90.0	11.6	182/184TC	GP0052C	135	1,043	GPV0052C	97	1,043
5	1800	89.5	80.0	13.1	182/184TC	GP0054C	135	1,066	GPV0054C	94	1,066
5	1200	90.2	73.5	14.1	213/215TC	GP0056C	210	1,815	GPV0056C	189	1,815
7.5	3600	90.2	84.5	18.4	213/215TC	GP7/52C	180	1,694	GPV7/52C	141	1,694
7.5	1800	91.7	83.0	18.5	213/215TC	GP7/54C	200	1,693	GPV7/54C	135	1,693
10	3600	91.0	86.0	23.9	213/215TC	GP0102C	220	1,906	GPV0102C	186	1,906
10	1800	91.7	85.0	24.0	213/215TC	GP0104C	219	2,027	GPV0104C	183	2,027

Note:

1. Motors on this page do not include Drip Cover. Drip covers are available. See page 144.
2. Data subject to change without notice.

ROLLED STEEL TEFC AEGIS® SGR



AEGH, FOOTED, NEMA PREMIUM WITH AEGIS® SGR (1 HP - 10 HP) [GP_G]

Effective: 01-01-2022
Supersedes: 07-06-2021



APPLICATIONS:

- Fans & Blowers
- Pumps
- Compressors
- HVAC Equipment

The AEGIS® SGR Bearing Protection Ring prevents electrical bearing "fluting" damage by safely diverting harmful shaft voltages and bearing currents to ground. Using proprietary Electron Transport Technology™, the conductive microfibers inside the AEGIS® SGR provide the most reliable current diversion technology for shaft grounding with a "path of least resistance" to dramatically extend motor life.
AEGIS® Shaft Grounding Rings have a warranty of 1 year.

FEATURES:

- Output Range: 1 - 10 HP
- Speed: 3600, 1800, 1200 RPM
- Enclosure: Totally Enclosed Fan Cooled (IP44)
- Voltage: 230/460V (Usable on 200 & 208V)
- Three Phase, 60 Hz, 1.15 Service Factor (Continuous); 50 Hz, 1.0 Service Factor (Continuous)
- Grounding Ring Factory Installed Externally on NDE Bracket
- Class F Insulation
- Class B Temperature Rise
- NEMA Design B Torques
- Rolled Steel Frame, Fan Cover, and Main Conduit Box
- Grounding Terminal Inside Main Conduit Box
- Oversized Main Conduit Box Rotatable in 90 Degree Increments - F1 Mounted Only (F2 not available)
- Designed for 40°C Ambient Temperature¹
- Designed for 3300 ft. Elevation²
- Bi-Directional Rotation
- Cast Iron End Brackets
- 1045 Carbon Steel Shaft
- Aluminum Die Cast Squirrel Cage Rotor Construction
- Paint System: Phenolic Rust Proof Base Plus Polyurethane Top Coat
- Paint Color: Blue - Munsell 5PB 3/8
- Double Shielded Bearings Pre-Packed with MULTEMP SRL (Non-regreasable)
- Stainless Steel Nameplate
- Dual Column Design Nameplate as Standard (60/50 Hz)
- Suitable for Inverter Use per NEMA MG-1 Part 31.4.4.2^(3,4)
- Inverter Duty Speed Range: 20:1 Variable Torque, 10:1 Constant Torque
- 9 Leads for 5 HP and Smaller
- 12 Leads for 7.5 HP and Larger
- Motors are U.L. Recognized for United States and Canada, CSA Approved and CE Marked

EXTRAS/ OPTIONS:

Please refer to pages 147 - 152 for common modifications that can be performed.

Notes:

1. Consult a Stock Product Application Specialist for suitability in higher ambient environments.
2. Consult a Stock Product Application Specialist for suitability at higher elevations.
3. Motor service factor is 1.0 when operated on a VFD.
4. Precautions should be taken to eliminate or reduce shaft currents that may be imposed on the motor by the VFD as stated per NEMA MG-1, Part 31.
5. AEGIS® SGR Bearing Protection Ring can not be used in Hazardous Locations (e.g. Class I, Div. 2, etc.)

ROLLED STEEL TEFC AEGIS® SGR



AEGH, FOOTED, NEMA PREMIUM WITH AEGIS® SGR [GP_G]

Effective: 01-01-2022
Supersedes: 07-06-2021



CATALOG NUMBER	HP	RPM	FRAME	FL EFF %	FL PF %	FL AMPS (230V)	APPROX SHIPPING WT. (lbs.)	LIST PRICE (\$)
GP0012G	1	3600	56/143/145T	80.0	85.5	2.74	33	597
GP0014G	1	1800	56/143/145T	85.5	75.5	2.90	41	617
GP0016G	1	1200	56/143/145T	82.5	66.0	3.44	43	760
GP1/52G	1.5	3600	56/143/145T	85.5	83.0	3.96	33	678
GP1/54G	1.5	1800	56/143/145T	86.5	80.5	4.03	46	684
GP1/56G	1.5	1200	182/184T	87.5	55.0	5.84	75	832
GP0022G	2	3600	56/143/145T	86.5	85.0	5.09	41	719
GP0024G	2	1800	56/143/145T	86.5	79.0	5.48	46	730
GP0026G	2	1200	182/184T	88.5	64.5	6.56	97	913
GP0032G	3	3600	182/184T	87.5	87.5	7.34	84	870
GP0034G	3	1800	182/184T	89.5	74.0	8.48	69	847
GP0036G	3	1200	213/215T	89.5	68.0	9.23	145	1,173
GP0052G	5	3600	182/184T	89.5	90.0	11.6	97	1,043
GP0054G	5	1800	182/184T	89.5	80.0	13.1	94	957
GP0056G	5	1200	213/215T	90.2	73.5	14.1	189	1,642
GP7/52G	7.5	3600	213/215T	90.2	84.5	18.4	141	1,515
GP7/54G	7.5	1800	213/215T	91.7	83.0	18.5	135	1,388
GP0102G	10	3600	213/215T	91.0	86.0	23.9	186	1,587
GP0104G	10	1800	213/215T	91.7	85.0	24.0	183	1,632

Notes:

1. Data subject to change without notice.



APPLICATIONS:

- Fans & Blowers
- Pumps
- Any Application that Requires IEC Mounting Dimensions
- Compressors

FEATURES:

- Output Range: 1 - 150 HP (0.75 - 112 kW)
- Speed: 3600, 1800, 1200 RPM
- Enclosure: Totally Enclosed Fan Cooled (IP55)
- Voltage: 230/460V (Usable on 208V)¹ Ratings 150 HP and higher are 460V only
- Three Phase, 60 Hz, 1.15 Service Factor (Continuous); 50 Hz, 1.0 Service Factor (Continuous)
- Class F Insulation
- Class B Temperature Rise
- Cast Iron Frame, End Brackets and Main Conduit Box; Rolled Steel Fan Cover
- Grounding Terminal Inside Main Conduit Box
- Oversized Main Conduit Box Rotatable in 90 Degree Increments - F3 Mounted (IM1001)
- Designed for 40°C Ambient Temperature²
- Designed for 3300 ft. Elevation³
- Bi-Directional Rotation
- 1045 Carbon Steel Shaft
- Aluminum Die Cast Squirrel Cage Rotor Construction
- Paint System: Phenolic Rust Proof Base Plus Polyurethane Top Coat
- Paint Color: Blue - Munsell 5PB 3/8
- Double Shielded Bearings Pre-Packed with MULTEMP SRL for F# 80 - 225 (Non-regreasable)
- High Quality Ball (or Roller) Bearings Regreasable with MULTEMP SRL for F# 250 and Larger
- Oil Seal/V-Ring on Both Ends
- Stainless Steel Nameplate
- Dual Column Design Nameplate as Standard (60/50 Hz)
- Suitable for Inverter Use per NEMA MG-1 Part 31.4.4.2^(4,5)
- Inverter Duty Speed Range: 20:1 Variable Torque, 10:1 Constant Torque
- 9 Leads for 5 HP & smaller; 12 Leads for 7.5 HP to 125 HP; 6 Leads for 150 HP and Larger
- Motors are CE Marked

EXTRAS/ OPTIONS:

Please refer to pages 147 - 152 for common modifications that can be performed.

Notes:

1. Suitable for Wye/Delta Starting and part winding on 230V.
2. Consult a Stock Product Application Specialist for suitability in higher ambient environments.
3. Consult a Stock Product Application Specialist for suitability at higher elevations.
4. Motor service factor is 1.0 when operated on a VFD.
5. Precautions should be taken to eliminate or reduce shaft currents that may be imposed on the motor by the VFD as stated by NEMA MG-1. Part 31.



CATALOG NUMBER	KW	HP	RPM	FRAME	FL EFF %	FL PF %	FL AMPS (460V)	APPROX. SHIPPING WT. KG (lbs.)	LIST PRICE (\$)
MP0012	0.75	1	3600	80M	77.0	84.0	1.46	18 (40)	524
MP0014	0.75	1	1800	80M	85.5	74.5	1.48	21 (46)	526
MP0016	0.75	1	1200	90S	82.5	70.0	1.63	28 (61)	627
MP1/52	1.1	1.5	3600	80M	84.0	85.0	1.93	20 (44)	587
MP1/54	1.1	1.5	1800	90S	86.5	81.0	1.97	27 (59)	587
MP1/56	1.1	1.5	1200	112M	87.5	64.0	2.47	31 (68)	744
MP0022	1.5	2	3600	90S	85.5	89.5	2.46	25.5 (56)	627
MP0024	1.5	2	1800	90S/90L	86.5	75.0	2.90	28.5 (63)	624
MP0026	1.5	2	1200	112M	88.5	69.0	3.08	43.5 (96)	812
MP0032	2.2	3	3600	90S/90L	86.5	89.0	3.59	29 (64)	756
MP0034	2.2	3	1800	100L	89.5	83.5	3.69	39.5 (87)	732
MP0036	2.2	3	1200	112M	89.5	67.5	4.09	53.5 (118)	1,055
MP0042	3.0	4	3600	100L	88.5	88.0	4.83	41.5 (91.5)	925
MP0044	3.0	4	1800	100L	89.5	78.5	5.36	42 (93)	855
MP0046	3.0	4	1200	132S	89.5	78.5	5.36	75 (165)	1,454
MP5/52	4.0	5.5	3600	112M	88.5	91.0	6.23	51 (113.5)	966
MP5/54	4.0	5.5	1800	112M	89.5	81.5	6.88	53 (117)	883
MP5/56	4.0	5.5	1200	132S/132M	89.5	79.5	7.06	91.5 (202)	1,470
MP7/52	5.5	7.5	3600	132S	89.5	86.5	8.92	73 (161)	1,262
MP7/54	5.5	7.5	1800	132S	91.7	85.0	8.86	75.5 (166)	1,278
MP7/56	5.5	7.5	1200	132S/132M	91.0	74.5	10.2	91 (200)	2,085
MP0102	7.5	10	3600	132S	90.2	87.5	11.9	76 (167)	1,454
MP0104	7.5	10	1800	132S/132M	91.7	85.5	12.0	93 (205)	1,522
MP0106	7.5	10	1200	160M	91.0	81.5	12.7	135 (298)	2,414
MP0152	11	15	3600	160M	91.0	92.5	16.4	130 (287)	2,029
MP0154	11	15	1800	160M	92.4	87.0	17.2	131 (287)	2,042
MP0156	11	15	1200	160M/160L	91.7	81.5	18.5	150 (331)	3,267
MP0202	15	20	3600	160M	91.0	92.5	22.4	130 (287)	2,515
MP0204	15	20	1800	160M/160L	93.0	86.5	23.4	150 (331)	2,547
MP0206	15	20	1200	180L	91.7	83.0	24.7	205 (452)	4,121
MP0252	18.5	25	3600	160M/160L	91.7	93.0	27.2	140 (308.5)	3,314
MP0254	18.5	25	1800	180M	93.6	82.5	30.1	195 (430)	3,098
MP0256	18.5	25	1200	200L	93.0	82.0	30.4	270 (595)	5,599
MP0302	22	30	3600	180M	91.7	90.0	32.0	180 (397)	3,842
MP0304	22	30	1800	180M/180L	93.6	84.0	33.6	205 (452)	3,784
MP0306	22	30	1200	200L	93.0	82.0	34.6	290 (639)	5,947
MP0402	30	40	3600	200L	92.4	91.0	42.8	265 (584)	5,693
MP0404	30	40	1800	200L	94.1	89.5	42.8	285 (628)	5,546
MP0406	30	40	1200	225S/225M	94.1	86.5	44.2	385 (849)	8,413
MP0502	37	50	3600	200L	93.0	91.0	52.5	300 (661)	6,904
MP0504	37	50	1800	225S	94.5	86.5	54.3	350 (772)	7,229
MP0506	37	50	1200	250M	94.1	88.0	53.6	460 (1014)	11,818
MP0602	45	60	3600	225S/225M	93.6	93.5	61.7	340 (750)	9,267
MP0604	45	60	1800	225S/225M	95.0	86.5	65.7	360 (794)	8,516
MP0606	45	60	1200	280S	94.5	85.5	69.5	600 (1322)	13,775
MP0752	56	75	3600	250M	93.6	93.0	75.9	465 (1025)	13,444
MP0754	56	75	1800	250M	95.4	88.0	78.7	480 (1058)	12,151
MP0756	56	75	1200	280M	94.5	84.5	87.9	660 (1455)	14,109
MP1002	75	100	3600	280S	94.1	89.5	111	585 (1290)	18,341
MP1004	75	100	1800	280S	95.4	87.5	112	620 (1367)	14,483
MP1006	75	100	1200	315S	95.0	84.0	117	900 (1984)	16,425
MP1252	93	125	3600	280M	95.0	89.5	138	615 (1356)	18,448
MP1254	93	125	1800	280M	95.4	88.5	139	690 (1521)	17,302
MP1256	93	125	1200	315M	95.0	84.5	146	960 (2116)	21,599
MP1502	112	150	3600	315S	95.0	91.0	162	860 (1896)	21,293
MP1504	112	150	1800	315S	95.8	88.0	167	960 (2116)	19,028
MP1506	112	150	1200	315M	95.8	84.5	173	1160 (2557)	24,058

Notes:

1. Data subject to change without notice.
2. Conversion from KG to lbs at 2.20462 and rounded

MAX-PM™ PERMANENT MAGNET



DVEM, PERMANENT MAGNET SYNCHRONOUS MOTOR, TEFC (1HP - 30 HP) [PM]

Effective: 01-01-2022
Supercedes: 07-06-2021



APPLICATIONS:

- Pumps
- Fans
- Grinders

FEATURES:

- Output: 1 - 30 HP
- Speed: 3600,1800,1200 RPM
- Enclosure: Totally Enclosed Fan Cooled (IP55)
- Voltage: 230/460V
- Three Phase, 60 Hz, 1.0 Service Factor (Continuous)
- Class F Insulation
- Class B Temperature Rise
- IE4 Efficiency Level
- Rolled Steel Fan Cover, and Main Conduit Box Rotatable in 90 Degree Increments
- Cast Iron Frame, End Brackets
- Grounding Terminal Inside Main Conduit Box
- Oversized Main Conduit Box - F1 Mounted, F2 Convertible.
- Designed for 40°C Ambient Temperature¹
- Designed for 3300 ft. Elevation²
- Bi-Directional Rotation
- 1045 Carbon Steel Shaft
- Permanent Magnet Rotor Construction (NdFeB)
- Double Shielded Bearings Pre-Packed with MULTEMP SRL
- Stainless Steel Nameplate
- Paint System: Phenolic Rust Proof Base Plus Polyurethane Top Coat
- Paint Color: Green - Munsell 10GY 5/12
- Method of Starting: Controlled by Permanent Magnet Synchronous Motor Drive
- Over Torque: 150% Rated Torque for 60 Seconds
- 9 Leads
- Two Drain Holes on Bottom of Frame
- Motors are cCSAus Approved, and CE Marked

EXTRAS/ OPTIONS:

Please refer to pages 147 - 152 for common modifications that can be performed.

Notes:

1. Consult a Stock Product Application Specialist for suitability in higher ambient environments.
2. Consult a Stock Product Application Specialist for suitability at higher elevations.

MAX-PM™ PERMANENT MAGNET



DVEM, PERMANENT MAGNET SYNCHRONOUS MOTOR, TEFC [PM]

Effective: 01-01-2022
Supersedes: 07-06-2021

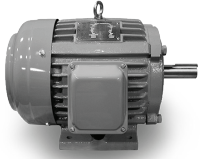

HP	RPM	FRAME	FL EFF %	INDUCED VOLTAGE CONSTANT (V/krpm)	FL AMPS (460V)	APPROX. SHIPPING WT. (lbs.)	FOOTED	
							CATALOG NUMBER	LIST PRICE (\$)
1	3600	143T	83.5	89.0	1.50	33	PM0012	843
1	1800	143T	85.7	171	1.50	33	PM0014	853
1	1200	145T	82.7	258	1.50	42	PM0016	1,023
1.5	3600	143T	85.2	91.0	2.20	37	PM1/52	926
1.5	1800	145T	87.2	169	2.30	42	PM1/54	1,025
1.5	1200	182T	84.5	267	2.20	72	PM1/56	1,446
2	3600	145T	86.5	91.0	3.00	36	PM0022	968
2	1800	145T	88.2	169	3.00	46	PM0024	1,089
2	1200	184T	85.9	267	2.90	69	PM0026	1,509
3	3600	182T	88.0	88.0	4.40	66	PM0032	1,285
3	1800	182T	89.5	182	4.50	66	PM0034	1,396
3	1200	213T	87.4	267	4.40	107	PM0036	2,061
5	3600	184T	89.7	90.0	7.10	69	PM0052	1,442
5	1800	184T	90.9	181	7.00	90	PM0054	1,576
5	1200	215T	89.3	274	7.00	115	PM0056	2,341
7.5	3600	213T	90.9	88.0	11.0	95	PM7/52	1,825
7.5	1800	213T	91.9	180	10.4	101	PM7/54	1,965
7.5	1200	254T	90.5	275	10.2	176	PM7/56	3,011
10	3600	215T	91.7	94.0	14.0	107	PM0102	2,159
10	1800	215T	92.6	179	14.5	115	PM0104	2,328
10	1200	256T	91.3	272	14.5	216	PM0106	3,611
15	3600	254T	92.6	94.0	20.0	163	PM0152	2,725
15	1800	254T	93.3	190	20.0	176	PM0154	3,171
15	1200	284T	92.3	286	20.0	299	PM0156	4,720
20	3600	256T	93.3	95.0	28.0	186	PM0202	3,122
20	1800	256T	93.9	181	28.0	196	PM0204	3,765
20	1200	286T	92.9	283	27.5	326	PM0206	4,908
25	3600	284TS	93.7	95.0	33.5	267	PM0252	4,076
25	1800	284T	94.2	195	33.0	299	PM0254	4,009
30	3600	286TS	94.0	98.0	39.5	312	PM0302	4,640
30	1800	286T	94.5	193	39.5	326	PM0304	4,591

Note:

1. Select catalog numbers have changed in order to follow the following format:
2. Data subject to change without notice.

MAX-PM™ PERMANENT MAGNET



DVEM, PERMANENT MAGNET SYNCHRONOUS MOTOR, TEFC [PM]

Effective: 01-01-2022
Supersedes: 07-06-2021

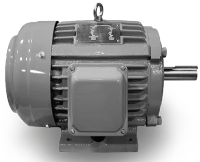

HP	RPM	FRAME	FL EFF %	INDUCED VOLTAGE CONSTANT (V/krpm)	FL AMPS (460V)	APPROX. SHIPPING WT. (lbs.)	FOOTED	
							CATALOG NUMBER	LIST PRICE (\$)
1	3600	143TC	83.5	89.0	1.50	33	PM0012C	938
1	1800	143TC	85.7	171	1.50	33	PM0014C	959
1	1200	145TC	82.7	258	1.50	42	PM0016C	1,117
1.5	3600	143TC	85.2	91.0	2.20	37	PM1/52C	1,019
1.5	1800	145TC	87.2	169	2.30	42	PM1/54C	1,111
1.5	1200	182TC	84.5	267	2.20	72	PM1/56C	1,604
2	3600	145TC	86.5	91.0	3.00	36	PM0022C	1,063
2	1800	145TC	88.2	169	3.00	46	PM0024C	1,176
2	1200	184TC	85.9	267	2.90	69	PM0026C	1,667
3	3600	182TC	88.0	88.0	4.40	66	PM0032C	1,442
3	1800	182TC	89.5	182	4.50	66	PM0034C	1,493
3	1200	213TC	87.4	267	4.40	107	PM0036C	2,401
5	3600	184TC	89.7	90.0	7.10	69	PM0052C	1,600
5	1800	184TC	90.9	181	7.00	90	PM0054C	1,669
5	1200	215TC	89.3	274	7.00	115	PM0056C	2,681
7.5	3600	213TC	90.9	88.0	11.0	95	PM7/52C	2,165
7.5	1800	213TC	91.9	180	10.4	101	PM7/54C	2,256
7.5	1200	254TC	90.5	275	10.2	176	PM7/56C	3,373
10	3600	215TC	91.7	94.0	14.0	107	PM0102C	2,431
10	1800	215TC	92.6	179	14.5	115	PM0104C	2,627
10	1200	256TC	91.3	272	14.5	216	PM0106C	3,973
15	3600	254TC	92.6	94.0	20.0	163	PM0152C	3,086
15	1800	254TC	93.3	190	20.0	176	PM0154C	3,497
15	1200	284TC	92.3	286	20.0	299	PM0156C	5,148
20	3600	256TC	93.3	95.0	28.0	186	PM0202C	3,122
20	1800	256TC	93.9	181	28.0	196	PM0204C	4,094
20	1200	286TC	92.9	283	27.5	326	PM0206C	5,338
25	3600	284TSC	93.7	95.0	33.5	267	PM0252C	4,505
25	1800	284TC	94.2	195	33.0	299	PM0254C	4,398
30	3600	286TSC	94.0	98.0	39.5	312	PM0302C	5,068
30	1800	286TC	94.5	193	39.5	326	PM0304C	4,985

Note:

1. Select catalog numbers have changed in order to follow the following format:
2. Data subject to change without notice.

CAST IRON TEFC JP/JM



AEHH8NJP/JM, NEMA PREMIUM, CLOSE-COUPLED (1 HP - 50 HP) [JPP/JMP]

Effective: 01-01-2022
Supersedes: 07-06-2021



APPLICATIONS:

- Pumps

FEATURES:

- Output Range: 3/4 - 50 HP
- Speed: 3600, 1800, 1200 RPM
- Enclosure: Totally Enclosed Fan Cooled (IP54)
- Voltage: 230/460V (Usable on 208V)
- Three Phase, 60 Hz, 1.15 Service Factor (Continuous); 50 Hz, 1.0 Service Factor (Continuous)
- CSA Certified for Class I, Div. 2, Groups B, C & D - Temp Code T3C Minimum⁵
- Class F Insulation
- Class B Temperature Rise
- NEMA Design B Torques
- Cast Iron Frame, End Brackets & Fan Cover and Main Conduit Box
- Grounding Terminal Inside Main Conduit Box
- Oversized Main Conduit Box Rotatable in 90 Degree Increments - F1 Mounted
- Designed for 40°C Ambient Temperature¹
- Designed for 3300 ft. Elevation²
- Bi-Directional Rotation
- 1045 Carbon Steel Shaft
- Aluminum Die Cast Squirrel Cage Rotor Construction
- Paint System: Phenolic Rust Proof Base Plus Polyurethane Top Coat
- Paint Color: Premium - Light Gray - Munsell N5.0
High Efficient - Dark Gray - Munsell 7.5B 3.5/0.5
- Double Shielded Bearings Pre-Packed with MULTEMP SRL for F# 140JP/JM - 280JP/JM (Non-regreasable)
- High Quality Ball (or Roller) Bearings Regreasable with Mobil Polyrex™ EM for F# 280JP/JM (2P), 320JP/JM and Larger
- Automatic Grease Discharge Fittings on Regreasable Models
- Rubber Dust Flinger on DE for F# 140JP/JM - 280JP/JM
- Metal Flinger on Both Ends for F# 280JP/JM (2P), 320JP/JM and Larger
- Cast Iron Inner and Outer Bearing Caps for Frame# 280JP/JM (2P), 320JP/JM and Larger
- Stainless Steel Nameplate
- Dual Column Design Nameplate as Standard (60/50 Hz)
- Suitable for Inverter Use per NEMA MG-1 Part 31.4.4.2^(3,4)
- Inverter Duty Speed Range: 10:1 Variable Torque, 5:1 Constant Torque
- 9 Leads for 5 HP and Smaller
- 12 Leads for 7.5 HP to 125 HP
- Motors are U.L. Recognized, CSA Approved and CE Marked

EXTRAS/ OPTIONS:

Please refer to pages 147 - 152 for common modifications that can be performed.

Notes:

1. Consult a Stock Product Application Specialist for suitability in higher ambient environments.
2. Consult a Stock Product Application Specialist for suitability at higher elevations.
3. Motor service factor is 1.0 when operated on a VFD.
4. Precautions should be taken to eliminate or reduce shaft currents that may be imposed on the motor by the VFD as stated per NEMA MG-1. Part 31.
5. CSA Certification for Hazardous Location only applies to AEHH8NJP/JM, NEMA premium [JPP/JMP] product line.

CAST IRON TEFC JP/JM



AEHH8NJP/JM, NEMA PREMIUM, CLOSE-COUPLED [JPP/JMP]

Effective: 01-01-2022
Supersedes: 07-06-2021



HP	RPM	FL EFF %	FL PF %	FL AMPS (230V)	JPP				JMP			
					FRAME	JP CATALOG NUMBER	APPROX. JP SHIPPING WT. (lbs.)	LIST PRICE (\$)	FRAME	JM CATALOG NUMBER	APPROX. JM SHIPPING WT. (lbs.)	LIST PRICE (\$)
1	1800	85.5	73.0	1.50	143JP	JPP0014	61	683	143JM	JMP0014	61	683
1	1200	82.5	65.5	1.73	143/145JP	JPP0016	61	825	143/145JM	JMP0016	61	825
1.5	3600	84.0	83.5	2.00	143JP	JPP1/52	68	746	143JM	JMP1/52	68	746
1.5	1800	86.5	78.0	2.08	143/145JP	JPP1/54	61	744	143/145JM	JMP1/54	61	744
1.5	1200	87.5	63.5	2.53	182JP	JPP1/56	68	886	182JM	JMP1/56	68	886
2	3600	86.5	86.0	2.52	143/145JP	JPP0022	106	799	143/145JM	JMP0022	106	799
2	1800	86.5	78.0	2.78	143/145JP	JPP0024	68	798	143/145JM	JMP0024	68	798
2	1200	88.5	70.5	3.00	184JP	JPP0026	68	993	182/184JM	JMP0026	68	993
3	3600	88.5	90.0	3.53	182JP	JPP0032	126	933	182JM	JMP0032	126	933
3	1800	89.5	84.0	3.74	182JP	JPP0034	106	907	182JM	JMP0034	106	907
3	1200	89.5	78.0	4.02	213JP	JPP0036	106	1,403	213JM	JMP0036	106	1,403
5	3600	88.5	92.5	5.72	182/184JP	JPP0052	186	1,167	182/184JM	JMP0052	186	1,167
5	1800	89.5	85.5	6.12	182/184JP	JPP0054	126	1,066	182/184JM	JMP0054	126	1,066
5	1200	91.0	82.5	6.24	213/215JP	JPP0056	126	1,820	213/215JM	JMP0056	126	1,820
7.5	3600	91.0	89.0	8.67	213JP	JPP7/52	213	1,441	213JM	JMP7/52	213	1,441
7.5	1800	91.7	86.5	8.85	213JP	JPP7/54	186	1,387	213JM	JMP7/54	186	1,387
7.5	1200	91.0	80.5	9.59	254JP	JPP7/56	186	2,389	254JM	JMP7/56	186	2,389
10	3600	91.0	89.5	11.5	213/215JP	JPP0102	325	1,686	213/215JM	JMP0102	325	1,686
10	1800	91.7	88.0	11.6	213/215JP	JPP0104	213	1,653	213/215JM	JMP0104	213	1,653
10	1200	91.0	80.5	12.8	254/256JP	JPP0106	213	2,976	254/256JM	JMP0106	213	2,976
15	3600	92.4	91.5	16.6	254JP	JPP0152	354	2,312	254JM	JMP0152	354	2,312
15	1800	92.4	88.0	17.3	254JP	JPP0154	325	2,274	254JM	JMP0154	325	2,274
15	1200	92.4	83.5	18.2	284JP	JPP0156	325	3,893	284JM	JMP0156	325	3,893
20	3600	92.4	92.5	21.9	254/256JP	JPP0202	464	2,953	254/256JM	JMP0202	464	2,953
20	1800	93.0	87.5	23.0	254/256JP	JPP0204	354	2,853	254/256JM	JMP0204	354	2,853
20	1200	91.7	84.0	24.3	284/286JP	JPP0206	354	4,879	284/286JM	JMP0206	354	4,879
25	3600	92.4	91.0	27.8	284JP	JPP0252	507	3,528	284JM	JMP0252	507	3,528
25	1800	93.6	86.0	29.1	284JP	JPP0254	464	3,355	284JM	JMP0254	464	3,355
25	1200	93.0	83.0	30.3	324JP	JPP0256	464	5,969	324JM	JMP0256	464	5,969
30	3600	93.0	91.0	33.2	284/286JP	JPP0302	694	4,103	284/286JM	JMP0302	694	4,103
30	1800	93.6	87.5	34.3	284/286JP	JPP0304	507	4,066	284/286JM	JMP0304	507	4,066
30	1200	93.0	80.5	37.5	324/326JP	JPP0306	507	6,402	324/326JM	JMP0306	507	6,402
40	3600	94.1	90.0	44.2	324JP	JPP0402	784	5,407	324JM	JMP0402	784	5,407
40	1800	94.1	86.0	46.3	324JP	JPP0404	694	5,319	324JM	JMP0404	694	5,319
40	1200	94.1	86.5	46.0	364JP	JPP0406	694	8,159	~	~	~	~
50	3600	94.1	91.0	54.7	324/326JP	JPP0502	926	6,647	324/326JM	JMP0502	926	6,647
50	1800	94.5	87.0	56.9	324/326JP	JPP0504	784	6,634	324/326JM	JMP0504	784	6,634
50	1200	94.1	86.0	57.8	365JP	JPP0506	784	10,504	~	~	~	~

Note:

1. Data subject to change without notice.

MAX-PE™ FAMILY



AEHH8P, NEMA PREMIUM (1 HP - 200 HP) [NP]

AEHH8PCF, NEMA PREMIUM, FOOTED C-FACE (1 HP - 200 HP) [NP_C]

AEUH8PDC, NEMA PREMIUM, ROUND BODY C-FACE (1 HP - 200 HP) [NPV_C]

Effective: 01-01-2022

Supersedes: 07-06-2021

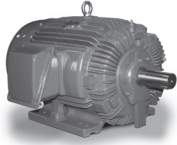

APPLICATIONS:

- Fans & Blowers
- Pumps
- Crushers
- Compressors
- Mixers
- Conveyors

FEATURES:

- Output Range: 1 - 200 HP
- Speed: 3600, 1800, 1200 RPM
- Enclosure: Totally Enclosed Fan Cooled (IP54)
- Voltage: 230/460V (Usable on 208V); 150HP and Larger is 460V Only¹
- Three Phase, 60 Hz, 1.15 Service Factor (Continuous); 50 Hz, 1.0 Service Factor (Continuous)
- CSA Certified for Class I, Div. 2, Groups B, C, D - Temp Code T3C
- Class F Insulation
- Class B Temperature Rise
- NEMA Design B Torques as a Minimum; Various Ratings also Meet Design C
- Cast Iron Frame and End Brackets; Rolled Steel Fan Cover and Main Conduit Box
- Grounding Terminal Inside Main Conduit Box
- Oversized Main Conduit Box Rotatable in 90 Degree Increments - F1 Mounted
- Designed for 40°C Ambient Temperature²
- Designed for 3300 ft. Elevation³
- Bi-Directional Rotation
- 1045 Carbon Steel Shaft
- Aluminum Die Cast Squirrel Cage Rotor Construction
- Paint System: Phenolic Rust Proof Base Plus Polyurethane Top Coat
- Paint Color: Dark Gray - Munsell 7.5B 3.5/0.5
- Double Shielded Bearings Pre-Packed with MULTEMP SRL for F# 140T - 280T (Non-regreasable)
- High Quality Ball (or Roller) Bearings Regreasable with Mobil Polyrex™ EM for F# 280TS and Larger
- Automatic Grease Discharge Fittings on Regreasable Models F# 280TS and Larger
- Rubber Dust Flinger on Drive End for F# 140T - 280T, Metal Flinger on Both Ends for F# 280TS and Larger
- Cast Iron Inner and Outer Bearing Caps for F#280TS and Larger
- Stainless Steel Nameplate
- Dual Column Design Nameplate as Standard (60/50 Hz)
- Suitable for Inverter Use per NEMA MG-1 Part 31.4.4.2^(4,5)
- Inverter Duty Speed Range: 20:1 Variable Torque, 10:1 Constant Torque
- 9 Leads for 5 HP and Smaller
- 12 Leads for 7.5 HP to 125 HP
- 6 Leads for 150 HP and Larger
- Motors are U.L. Recognized, CSA Approved and CE Marked
- Dual Drilled Feet Available on Most Ratings - Longer Frames (i.e. 145T Drilled also for 143T)
- Provisions for Breather Drains for Vertical Mount Down (F# 324T and Larger)
- Rubber Dust Flinger on Drive-End for F# 140T - 280T

EXTRAS/ OPTIONS:

Please refer to pages 147 - 152 for common modifications that can be performed.

Notes:

1. Motors 7.5 HP & up are Suitable for Wye/Delta Starting.
2. Consult a Stock Product Application Specialist for suitability in higher ambient environments.
3. Consult a Stock Product Application Specialist for suitability at higher elevations.
4. Motor service factor is 1.0 when operated on a VFD.
5. Precautions should be taken to eliminate or reduce shaft currents that may be imposed on the motor by the VFD as stated per NEMA MG-1. Part 31.

AEHH8P, NEMA PREMIUM [NP]

Effective: 01-01-2022
Supersedes: 07-06-2021



CATALOG NUMBER	HP	RPM	FRAME	FL EFF %	FL PF %	FL AMPS (460V)	APPROX SHIPPING WT. (lbs.)	LIST PRICE (\$)
NP0012	1	3600	143T	82.5	85.0	1.34	41	539
NP0014	1	1800	143T	85.5	73.0	1.50	43	514
NP0016	1	1200	143/145T	82.5	65.5	1.73	49	623
NP1/52	1.5	3600	143T	84.0	83.5	2.00	43	562
NP1/54	1.5	1800	143/145T	86.5	78.0	2.08	47	576
NP1/56	1.5	1200	182T	87.5	63.5	2.53	77	656
NP0022	2	3600	143/145T	86.5	86.0	2.52	44	585
NP0024	2	1800	143/145T	86.5	78.0	2.78	49	594
NP0026	2	1200	182/184T	88.5	70.5	3.00	97	734
NP0032	3	3600	182T	88.5	90.0	3.53	77	688
NP0034	3	1800	182T	89.5	84.0	3.74	85	669
NP0036	3	1200	213T	89.5	78.0	4.02	143	1,021
NP0052	5	3600	182/184T	88.5	92.5	5.72	88	845
NP0054	5	1800	182/184T	89.5	85.5	6.12	90	771
NP0056	5	1200	213/215T	91.0	82.5	6.24	172	1,382
NP7/52	7.5	3600	213T	91.0	89.0	8.67	141	1,148
NP7/54	7.5	1800	213T	91.7	86.5	8.85	151	1,191
NP7/56	7.5	1200	254T	91.0	80.5	9.59	250	1,882
NP0102	10	3600	213/215T	91.0	89.5	11.5	154	1,334
NP0104	10	1800	213/215T	91.7	88.0	11.6	170	1,379
NP0106	10	1200	254/256T	91.0	80.5	12.8	297	2,286
NP0152	15	3600	254T	92.4	91.5	16.6	263	1,818
NP0154	15	1800	254T	92.4	88.0	17.3	290	1,771
NP0156	15	1200	284T	92.4	83.5	18.2	413	3,147
NP0202	20	3600	254/256T	92.4	92.5	21.9	312	2,315
NP0204	20	1800	254/256T	93.0	87.5	23.0	346	2,231
NP0206	20	1200	284/286T	91.7	84.0	24.3	468	3,949
NP0252	25	3600	284TS	92.4	91.0	27.8	398	2,951
NP0254	25	1800	284T	93.6	86.0	29.1	427	2,864
NP0254S	25	1800	284TS	93.6	86.0	29.1	427	2,864
NP0256	25	1200	324T	93.0	83.0	30.3	523	4,936
NP0302	30	3600	284/286TS	93.0	91.0	33.2	440	3,484
NP0304	30	1800	284/286T	93.6	87.5	34.3	468	3,332
NP0304S	30	1800	284/286TS	93.6	87.5	34.3	468	3,332
NP0306	30	1200	324/326T(X)	93.0	80.5	37.5	543	5,522
NP0402	40	3600	324TS(X)	94.1	90.0	44.2	540	4,613
NP0404	40	1800	324T(X)	94.1	86.0	46.3	503	4,478
NP0404S	40	1800	324TS(X)	94.1	86.0	46.3	503	4,478
NP0406	40	1200	364T	94.1	86.5	46.0	834	7,263
NP0502	50	3600	324/326TS(X)	94.1	91.0	54.7	612	6,183
NP0504	50	1800	324/326T(X)	94.5	87.0	56.9	565	5,670
NP0504S	50	1800	324/326TS(X)	94.5	87.0	56.9	565	5,670
NP0506	50	1200	364/365T	94.1	86.0	57.8	915	8,953

AEHH8P, NEMA PREMIUM [NP]

Effective: 01-01-2022
Supersedes: 07-06-2021



CATALOG NUMBER	HP	RPM	FRAME	FL EFF %	FL PF %	FL AMPS (460V)	APPROX SHIPPING WT. (lbs.)	LIST PRICE (\$)
NP0602	60	3600	364TS	94.1	93.0	64.2	788	8,120
NP0604	60	1800	364T	95.0	86.5	68.4	823	7,298
NP0604S	60	1800	364TS	95.0	86.5	68.4	823	7,298
NP0606	60	1200	404T	94.5	87.0	68.4	1,173	10,646
NP0752	75	3600	364/365TS	94.5	93.0	79.9	878	10,392
NP0754	75	1800	364/365T	95.4	86.5	85.1	924	9,417
NP0754S	75	1800	364/365TS	95.4	86.5	85.1	924	9,417
NP0754R	75	1800	364/365T	95.4	86.5	85.1	924	9,417
NP0756	75	1200	404/405T	94.5	86.5	85.9	1,269	12,653
NP0756R	75	1200	404/405T	94.5	86.5	85.9	1,269	12,653
NP1002	100	3600	404/405TS	95.4	92.0	107	1,162	14,038
NP1004	100	1800	404/405T	95.4	87.5	112	1,236	13,087
NP1004S	100	1800	404/405TS	95.4	87.5	112	1,236	13,087
NP1004R	100	1800	404/405T	95.4	87.5	112	1,236	13,087
NP1006	100	1200	444T	95.0	82.5	119	1,510	15,642
NP1006R	100	1200	444T	95.0	82.5	119	1,510	15,642
NP1252	125	3600	444TS	95.0	86.0	143	1,272	17,005
NP1254	125	1800	444T	95.4	84.0	146	1,380	15,948
NP1254S	125	1800	444TS	95.4	84.0	146	1,380	15,948
NP1254R	125	1800	444T	95.4	84.0	146	1,380	15,948
NP1256	125	1200	444/445T	95.0	83.0	148	1,691	20,570
NP1256R	125	1200	444/445T	95.0	83.0	148	1,691	20,570
NP1502 ²	150	3600	444/445TS	95.0	87.0	170	1,481	20,278
NP1504 ²	150	1800	444/445T	95.8	84.0	175	1,481	18,121
NP1504S ²	150	1800	444/445TS	95.8	84.0	175	1,510	18,121
NP1504R ²	150	1800	444/445T	95.8	84.0	175	1,510	18,121
NP1506 ²	150	1200	445/447T	95.8	83.5	176	2,073	22,914
NP1506R ²	150	1200	445/447T	95.8	83.5	176	2,073	22,914
NP2002 ²	200	3600	445/447TS	95.4	87.0	226	1,716	27,775
NP2004 ²	200	1800	445/447T	96.2	84.5	230	1,716	23,784
NP2004S ²	200	1800	445/447TS	96.2	84.5	230	1,923	23,784
NP2004R ²	200	1800	445/447T	96.2	84.5	230	1,923	23,784
NP2006 ²	200	1200	447/449T	95.8	84.0	233	2,247	29,968
NP2006R ²	200	1200	447/449T	95.8	84.0	233	2,247	29,968

Notes:

1. All data subject to change without notice.
2. Ratings 150 HP and Larger are 460V Only.
- C. Meets NEMA Design C Torque.

AEHH8PCF, NEMA PREMIUM, FOOTED C-FACE [NP_C]
 AEUH8PDC, NEMA PREMIUM, ROUND BODY C-FACE [NPV_C]

Effective: 01-01-2022
 Supercedes: 07-06-2021



HP	RPM	FRAME	FL EFF %	FL PF %	FL AMPS (460V)	APPROX. SHIPPING WT. (lbs.)	FOOTED C-FACE		ROUND BODY C-FACE	
							CATALOG NUMBER	LIST PRICE (\$)	CATALOG NUMBER	LIST PRICE (\$)
1	3600	143TC	82.5	85.0	1.34	50	NP0012C	521	NPV0012C	674
1	1800	143TC	85.5	73.0	1.50	50	NP0014C	559	NPV0014C	662
1	1200	143/145TC	82.5	65.5	1.73	64	NP0016C	719	NPV0016C	817
1.5	3600	143TC	84.0	83.5	2.00	56	NP1/52C	623	NPV1/52C	697
1.5	1800	143/145TC	86.5	78.0	2.08	60	NP1/54C	633	NPV1/54C	721
1.5	1200	182TC	87.5	63.5	2.53	86	NP1/56C	747	NPV1/56C	957
2	3600	143/145TC	86.5	86.0	2.52	60	NP0022C	677	NPV0022C	774
2	1800	143/145TC	86.5	78.0	2.78	62	NP0024C	689	NPV0024C	807
2	1200	182/184TC	88.5	70.5	3.00	109	NP0026C	846	NPV0026C	1,079
3	3600	182TC	88.5	90.0	3.53	86	NP0032C	816	NPV0032C	937
3	1800	182TC	89.5	84.0	3.74	99	NP0034C	778	NPV0034C	983
3	1200	213TC	89.5	78.0	4.02	152	NP0036C	1,231	NPV0036C	1,458
5	3600	182/184TC	88.5	92.5	5.72	116	NP0052C	960	NPV0052C	1,104
5	1800	182/184TC	89.5	85.5	6.12	117	NP0054C	851	NPV0054C	1,050
5	1200	213/215TC	91.0	82.5	6.24	185	NP0056C	1,570	NPV0056C	1,750
7.5	3600	213TC	91.0	89.0	8.67	153	NP7/52C	1,329	NPV7/52C	1,492
7.5	1800	213TC	91.7	86.5	8.85	175	NP7/54C	1,327	NPV7/54C	1,610
7.5	1200	254TC	91.0	80.5	9.59	268	NP7/56C	2,112	NPV7/56C	2,314
10	3600	213/215TC	91.0	89.5	11.5	161	NP0102C	1,544	NPV0102C	1,729
10	1800	213/215TC	91.7	88.0	11.6	187	NP0104C	1,614	NPV0104C	1,750
10	1200	254/256TC	91.0	80.5	12.8	402	NP0106C	2,622	NPV0106C	2,925
15	3600	254TC	92.4	91.5	16.6	283	NP0152C	2,114	NPV0152C	2,287
15	1800	254TC	92.4	88.0	17.3	290	NP0154C	2,038	NPV0154C	2,220
15	1200	284TC	92.4	83.5	18.2	471	NP0156C	3,661	NPV0156C	3,812
20	3600	254/256TC	92.4	92.5	21.9	371	NP0202C	2,708	NPV0202C	3,105
20	1800	254/256TC	93.0	87.5	23.0	402	NP0204C	2,587	NPV0204C	2,889
20	1200	284/286TC	91.7	84.0	24.3	501	NP0206C	4,634	NPV0206C	4,161
25	3600	284TSC	92.4	91.0	27.8	465	NP0252C	3,445	NPV0252C	3,707
25	1800	284TC	93.6	86.0	29.1	484	NP0254C	3,215	NPV0254C	3,611
25	1200	324TC	93.0	83.0	30.3	534	NP0256C	5,758	NPV0256C	5,457
30	3600	284/286TSC	93.0	91.0	33.2	458	NP0302C	4,086	NPV0302C	3,976
30	1800	284/286TC	93.6	87.5	34.3	535	NP0304C	3,910	NPV0304C	3,827
30	1200	324/326TC	93.0	80.5	37.5	543	NP0306C	6,508	NPV0306C	6,263
40	3600	324TSC	94.1	90.0	44.2	540	NP0402C	5,183	NPV0402C	5,205
40	1800	324TC	94.1	86.0	46.3	514	NP0404C	5,078	NPV0404C	5,017
40	1200	364TC	94.1	86.5	46.0	889	NP0406C	8,256	NPV0406C	7,964
50	3600	324/326TSC	94.1	91.0	54.7	603	NP0502C	6,867	NPV0502C	6,774
50	1800	324/326TC	94.5	87.0	56.9	565	NP0504C	6,378	NPV0504C	6,273
50	1200	364/365TC	94.1	86.0	57.8	961	NP0506C	9,985	NPV0506C	10,376
60	3600	364TSC	94.1	93.0	64.2	832	NP0602C	9,001	NPV0602C	8,517
60	1800	364TC	95.0	86.5	68.4	878	NP0604C	8,296	NPV0604C	8,432
60	1200	404TC	94.5	87.0	68.3	1,230	NP0606C	12,021	NPV0606C	11,559
75	3600	364/365TSC	94.5	93.0	79.9	926	NP0752C	11,522	NPV0752C	10,708
75	1800	364/365TC	95.4	86.5	85.1	970	NP0754C	10,438	NPV0754C	10,458
75	1200	404/405TC	94.5	86.5	85.9	1,322	NP0756C	14,031	NPV0756C	13,202
100	3600	404/405TSC	95.4	92.0	107	1,223	NP1002C	15,560	NPV1002C	13,269
100	1800	404/405TC	95.4	87.5	112	1,289	NP1004C	14,627	NPV1004C	13,300
100	1200	444TC	95.0	82.5	119	1,519	NP1006C	17,207	NPV1006C	16,362
125	3600	444TSC	95.0	86.0	143	1,281	NP1252C	18,707	NPV1252C	15,988
125	1800	444TC	95.4	84.0	146	1,389	NP1254C	17,544	NPV1254C	15,885
125	1800	444TSC	95.4	84.0	146	1,389	NP1254CS	17,544	~	~
125	1200	444/445TC	95.0	83.0	148	1,700	NP1256C	22,627	NPV1256C	17,906
150	3600	444/445TSC	95.0	87.0	170	1,490	NP1502C	22,307	NPV1502C	16,444
150	1800	444/445TC	95.8	84.0	175	1,519	NP1504C	19,933	NPV1504C	17,289
150	1800	444/445TSC	95.8	84.0	175	1,519	NP1504CS	19,933	~	~
150	1200	445/447TC	95.8	83.5	176	2,086	NP1506C	25,205	NPV1506C	20,895
200	3600	445/447TSC	95.4	87.0	226	1,729	NP2002C	30,552	NPV2002C	21,533
200	1800	445/447TC	96.2	84.5	230	1,936	NP2004C	26,162	NPV2004C	22,175
200	1800	445/447TSC	96.2	84.5	230	1,936	NP2004CS	26,162	~	~
200	1200	447/449TC	95.8	84.0	233	2,260	NP2006C	32,964	NPV2006C	23,236

- Notes:**
1. Data subject to change without notice.
 2. Ratings 150 HP and Larger are 460V Only.
 3. Meets NEMA Design C Torque .
 3. Footed C-Face Frame Size 140, BA dim = 2.25", Frame Size 180 BA dim = 2.75".

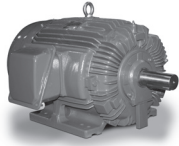

APPLICATIONS:

- Fans & Blowers
- Pumps
- Compressors
- HVAC Equipment

The AEGIS® SGR Bearing Protection Ring prevents electrical bearing "fluting" damage by safely diverting harmful shaft voltages and bearing currents to ground. Using proprietary Electron Transport Technology™, the conductive microfibers inside the AEGIS® SGR provide the most reliable current diversion technology for shaft grounding with a "path of least resistance" to dramatically extend motor life.
AEGIS® Shaft Grounding Rings have a warranty of 1 year.

FEATURES:

- Output Range: 1 - 75 HP
- Speed: 3600, 1800, 1200 RPM
- Enclosure: Totally Enclosed Fan Cooled (IP54)
- Voltage: 230/460V (Usable on 208V)
- Three Phase, 60 Hz, 1.15 Service Factor (Continuous); 50 Hz, 1.0 Service Factor (Continuous)
- Grounding Ring Factory Installed Externally on NDE Bracket for F# 143T - 286T; Internally on NDE for F# 284TS - 405T
- Class F Insulation
- Class B Temperature Rise
- NEMA Design B Torques as a Minimum; Various Ratings also Meet Design C
- Cast Iron Frame and End Brackets; Rolled Steel Fan Cover and Main Conduit Box
- Grounding Terminal Inside Main Conduit Box
- Oversized Main Conduit Box Rotatable in 90 Degree Increments - F1 Mounted
- Designed for 40°C Ambient Temperature²
- Designed for 3300 ft. Elevation³
- Bi-Directional Rotation
- 1045 Carbon Steel Shaft
- Aluminum Die Cast Squirrel Cage Rotor Construction
- Paint System: Phenolic Rust Proof Base Plus Polyurethane Top Coat
- Paint Color: Dark Gray - Munsell 7.5B 3.5/0.5
- Double Shielded Bearings Pre-Packed with MULTEMP SRL for F# 140T - 280T (Non-regreasable)
- High Quality Ball (or Roller) Bearings Regreasable with Mobil Polyrex™ EM for F# 280TS and Larger
- Automatic Grease Discharge Fittings on Regreasable Models
- Rubber Dust Flinger on Drive-End for 140T - 280T, Metal Flinger on Both Ends for F# 280TS and Larger
- Cast Iron Inner and Outer Bearing Caps for F#280TS and Larger
- Stainless Steel Nameplate
- Dual Column Design Nameplate as Standard (60/50 Hz)
- Suitable for Inverter Use per NEMA MG-1 Part 31.4.4.2^(4,5)
- Inverter Duty Speed Range: 20:1 Variable Torque, 10:1 Constant Torque
- 9 Leads for 5 HP and Smaller
- 12 Leads for 7.5 HP to 125 HP
- 6 Leads for 150 HP and Larger
- Motors are U.L. Recognized, CSA Approved and CE Marked
- Dual Drilled Feet Available on Most Ratings - Longer Frames (i.e. 145T Drilled also for 143T)
- Provisions for Breather Drains for Vertical Mount Down (F# 324T and Larger)
- Rubber Dust Flinger on Drive-End for F# 140T - 280T

EXTRAS/ OPTIONS:

Please refer to pages 147 - 152 for common modifications that can be performed.

Notes:

1. Motors 7.5 HP & up are Suitable for Wye/Delta Starting.
2. Consult a Stock Product Application Specialist for suitability in higher ambient environments.
3. Consult a Stock Product Application Specialist for suitability at higher elevations.
4. Motor service factor is 1.0 when operated on a VFD.
5. Precautions should be taken to eliminate or reduce shaft currents that may be imposed on the motor by the VFD as stated per NEMA MG-1, Part 31.
6. AEGIS® SGR Bearing Protection Ring can not be used in Hazardous Locations (e.g. Class I, Div. 2, etc.)

MAX-PE™ AEGIS® SGR



AEHH8P, NEMA PREMIUM [NP_G]

Effective: 01-01-2022
Supersedes: 07-06-2021



CATALOG NUMBER	HP	RPM	FRAME	FL EFF %	FL PF %	FL AMPS (460V)	APPROX SHIPPING WT. (lbs.)	LIST PRICE (\$)
NP0012G	1	3600	143T	82.5	85.0	1.34	83	627
NP0014G	1	1800	143T	85.5	73.0	1.50	48	651
NP0016G	1	1200	143/145T	82.5	65.5	1.73	90	799
NP1/52G	1.5	3600	143T	84.0	83.5	2.00	85	714
NP1/54G	1.5	1800	143/145T	86.5	78.0	2.08	78	720
NP1/56G	1.5	1200	182T	87.5	63.5	2.53	120	876
NP0022G	2	3600	143/145T	86.5	86.0	2.52	62	757
NP0024G	2	1800	143/145T	86.5	78.0	2.78	90	767
NP0026G	2	1200	182/184T	88.5	70.5	3.00	132	962
NP0032G	3	3600	182T	88.5	90.0	3.53	130	915
NP0034G	3	1800	182T	89.5	84.0	3.74	135	892
NP0036G	3	1200	213T	89.5	78.0	4.02	164	1,235
NP0052G	5	3600	182/184T	88.5	92.5	5.72	135	1,098
NP0054G	5	1800	182/184T	89.5	85.5	6.12	133	1,007
NP0056G	5	1200	213/215T	91.0	82.5	6.24	210	1,728
NP7/52G	7.5	3600	213T	91.0	89.0	8.67	180	1,467
NP7/54G	7.5	1800	213T	91.7	86.5	8.85	200	1,461
NP7/56G	7.5	1200	254T	91.0	80.5	9.59	315	2,316
NP0102G	10	3600	213/215T	91.0	89.5	11.5	220	1,669
NP0104G	10	1800	213/215T	91.7	88.0	11.6	219	1,718
NP0106G	10	1200	254/256T	91.0	80.5	12.8	340	2,761
NP0152G	15	3600	254T	92.4	91.5	16.6	325	2,246
NP0154G	15	1800	254T	92.4	88.0	17.3	316	2,190
NP0156G	15	1200	284T	92.4	83.5	18.2	530	3,765
NP0202G	20	3600	254/256T	92.4	92.5	21.9	380	2,797
NP0204G	20	1800	254/256T	93.0	87.5	23.0	395	2,697
NP0206G	20	1200	284/286T	91.7	84.0	24.3	520	4,654
NP0252G	25	3600	284TS	92.4	91.0	27.8	460	3,503
NP0254G	25	1800	284T	93.6	86.0	29.1	510	3,293
NP0256G	25	1200	324T	93.0	83.0	30.3	745	5,795
NP0302G	30	3600	284/286TS	93.0	91.0	33.2	508	4,096
NP0304G	30	1800	284/286T	93.6	87.5	34.3	545	3,952
NP0306G	30	1200	324/326T	93.0	80.5	37.5	775	6,421
NP0402G	40	3600	324TS	94.1	90.0	44.2	650	5,385
NP0404G	40	1800	324T	94.1	86.0	46.3	710	5,264
NP0406G	40	1200	364T	94.1	86.5	46.0	945	8,395
NP0502G	50	3600	324/326TS	94.1	91.0	54.7	775	7,144
NP0504G	50	1800	324/326T	94.5	87.0	56.9	795	6,592
NP0506G	50	1200	364/365T	94.1	86.0	57.8	1040	10,270
NP0602G	60	3600	364TS	94.1	93.0	64.2	890	9,297
NP0604G	60	1800	364T	95.0	86.5	68.4	870	8,441
NP0606G	60	1200	404T	94.5	87.0	68.3	1,295	12,238
NP0752G	75	3600	364/365TS	94.5	93.0	79.9	970	11,827
NP0754G	75	1800	364/365T	95.4	86.5	85.1	1,075	10,799
NP0756G	75	1200	404/405T	94.5	86.5	85.9	1,317	14,468

Notes:

1. Data subject to change without notice.
- C. Meets NEMA Design C Torque.

MAX-E1® FAMILY



AEHH8N, NEMA PREMIUM (1 HP - 400 HP) [EP]

AEHH8NCF, NEMA PREMIUM, FOOTED C-FACE (1 HP - 300 HP) [EP_C]

AEUH8NDC, NEMA PREMIUM, ROUND BODY C-FACE (1 HP - 100 HP) [EPV_C]

Effective: 01-01-2022
Supersedes: 07-06-2021



APPLICATIONS:

- Fans & Blowers
- Pumps
- Crushers
- Compressors
- Mixers
- Conveyors
- Any Severe Duty/ Petro-Chem/ Pulp & Paper Application

FEATURES:

- Output Range: 3/4 - 500 HP
- Speed: 3600, 1800, 1200, 900 RPM
- Enclosure: Totally Enclosed Fan Cooled (143T - 286T, IP54) - (286TS - 449T, IP55)
- Voltage: 230/460V (Usable on 208V); 150HP and Larger is 460V Only^{1,2}
- Three Phase, 60 Hz, 1.15 Service Factor (Continuous); 50 Hz, 1.0 Service Factor (Continuous)
- CSA Certified for Class I, Div. 2, Groups B, C, D - Temp Code T3 Minimum
- CSA Certified for Class II, Div 2, Group F & G - Temp Code T3 Minimum⁷ 444 Frame and Larger
- Class F Insulation
- Class B Temperature Rise
- NEMA Design B Torques as a Minimum; Various Ratings also Meet Design C
- Cast Iron Frame, End Brackets & Fan Cover and Main Conduit Box⁹
- Grounding Terminal Inside Main Conduit Box
- Oversized Main Conduit Box Rotatable in 90 Degree Increments - F1 Mounted
- Designed for 40°C Ambient Temperature³
- Designed for 3300 ft. Elevation⁴
- Bi-Directional Rotation, With the exception of 2 pole, # 5000 and Larger Ratings are Counter-Clockwise facing the DE
- 1045 Carbon Steel Shaft
- Aluminum Die Cast Squirrel Cage Rotor Construction for F# 140T - 449T
Copper/Copper Alloy Rotor Construction for F# 5000 and Larger¹⁰
- Paint System: Phenolic Rust Proof Base Plus Polyurethane Top Coat
- Paint Color: Light Gray - Munsell N5.0
- Double Shielded Bearings Pre-Packed with MULTEMP SRL for F# 140T - 280T (Non-regreasable)
- High Quality Ball (or Roller) Bearings Regreasable with Mobil Polyrex™ EM for F# 280TS and Larger
- Automatic Grease Discharge Fittings on Regreasable Models
- Metal Flinger on Both Ends for F# 286TS and Larger
- Cast Iron Inner and Outer Bearing Caps for F#280TS and Larger
- Stainless Steel Nameplate
- Dual Column Design Nameplate as Standard (60/50 Hz)
- Suitable for Inverter Use per NEMA MG-1 Part 31.4.4.2^(5,6)
- Inverter Duty Speed Range: 20:1 Variable Torque, 10:1 Constant Torque (350 HP and Larger are 3:1 Constant Torque)
- 9 Leads for 5 HP and Smaller
- 12 Leads for 7.5 HP to 125 HP
- 6 Leads for 150 HP and Larger
- Motors are U.L. Approved, CSA Approved. ABS Design Assessment from 250HP-500HP
- Dual Drilled Feet Available on Most Ratings - Longer Frames (i.e. 145T Drilled also for 143T)
- Rubber Dust Flinger on Drive-End for F# 140T - 280T
- Catalog Numbers Ending in "R" Come Standard with Roller Bearings for Belted Applications.

EXTRAS/ OPTIONS:

Please refer to pages 147 - 152 for common modifications that can be performed.

Notes:

1. TWMC carries minimal MAX-E1® 575V stock; please check availability to ensure required motors are available. Ratings may be available from our Canadian warehouses at a higher price or from our factory with a longer lead time. Pricing and lead time may vary.
2. Motors 7.5 HP & up are Suitable for Wye/Delta Starting.
3. Consult a Stock Product Application Specialist for suitability in higher ambient environments.
4. Consult a Stock Product Application Specialist for suitability at higher elevations.
5. Motor service factor is 1.0 when operated on a VFD.
6. Precautions should be taken to eliminate or reduce shaft currents that may be imposed on the motor by the VFD as stated per NEMA MG-1. Part 31.
7. Various temp codes apply to ratings. Consult a stock product specialist for accurate code.

AEHH8N, NEMA PREMIUM (1 HP - 400 HP) [EP]

Effective: 01-01-2022
 Supersedes: 07-06-2021

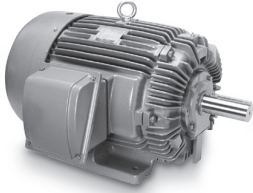

CATALOG NUMBER	HP	RPM	FRAME	FL EFF %	FL PF %	FL AMPS (460V or 575V)	APPROX. SHIPPING WT. (lbs.)	LIST PRICE (\$)
EP0/78	0.75	900	143/145T	84.0	81.5	1.84	65	1,097
EP0/785	0.75	900	143/145T	84.0	81.5	1.67	65	1,097
EP0012	1	3600	143T	82.5	85.0	1.34	52	528
EP00125	1	3600	143T	82.5	85.0	1.07	52	528
EP0014	1	1800	143T	85.5	73.0	1.50	50	531
EP00145	1	1800	143T	85.5	73.0	1.20	50	531
EP0016	1	1200	143/145T	82.5	65.5	1.73	64	688
EP00165	1	1200	143/145T	82.5	65.5	1.38	64	688
EP0018	1	900	182T	77.0	58.5	2.08	101	1,143
EP00185	1	900	182T	77.0	58.5	1.66	101	1,143
EP1/52	1.5	3600	143T	84.0	83.5	2.00	56	607
EP1/525	1.5	3600	143T	84.0	83.5	1.60	56	607
EP1/54	1.5	1800	143/145T	86.5	78.0	2.08	61	609
EP1/545	1.5	1800	143/145T	86.5	78.0	1.66	61	609
EP1/56	1.5	1200	182T	87.5	63.5	2.53	97	715
EP1/565	1.5	1200	182T	87.5	63.5	2.02	97	715
EP1/58	1.5	900	182/184T	78.5	60.5	2.96	108	1,362
EP1/585	1.5	900	182/184T	78.5	60.5	2.36	108	1,362
EP0022	2	3600	143/145T	86.5	86.0	2.52	64	639
EP00225	2	3600	143/145T	86.5	86.0	2.02	64	639
EP0024	2	1800	143/145T	86.5	78.0	2.78	62	649
EP00245	2	1800	143/145T	86.5	78.0	2.22	62	649
EP0026	2	1200	182/184T	88.5	70.5	3.00	107	917
EP00265	2	1200	182/184T	88.5	70.5	2.40	107	917
EP0028	2	900	213T	85.5	68.0	3.22	158	1,586
EP00285	2	900	213T	85.5	68.0	2.58	158	1,586
EP0032	3	3600	182T	88.5	90.0	3.53	99	751
EP00325	3	3600	182T	88.5	90.0	2.82	99	751
EP0034	3	1800	182T	89.5	81.5	3.85	102	734
EP00345	3	1800	182T	89.5	81.5	3.08	102	734
EP0036	3	1200	213T	89.5	78.0	4.02	161	1,057
EP00365	3	1200	213T	89.5	78.0	3.22	161	1,057
EP0038	3	900	213/215T	85.5	66.0	4.98	215	2,088
EP00385	3	900	213/215T	85.5	66.0	3.98	215	2,088

AEHH8N, NEMA PREMIUM (1 HP - 400 HP) [EP]

Effective: 01-01-2022
Supersedes: 07-06-2021

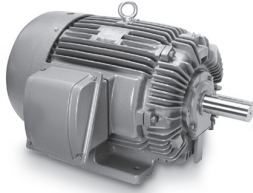

CATALOG NUMBER	HP	RPM	FRAME	FL EFF %	FL PF %	FL AMPS (460V or 575V)	APPROX. SHIPPING WT. (lbs.)	LIST PRICE (\$)
EP0052	5	3600	182/184T	88.5	92.5	5.72	118	929
EP00525	5	3600	182/184T	88.5	92.5	4.58	118	929
EP0054	5	1800	182/184T	89.5	85.5	6.12	107	846
EP00545	5	1800	182/184T	89.5	85.5	4.90	107	846
EP0056	5	1200	213/215T	91.0	82.5	6.24	218	1,517
EP00565	5	1200	213/215T	91.0	82.5	4.99	218	1,517
EP0058	5	900	254T	87.5	72.0	7.43	308	2,761
EP00585	5	900	254T	87.5	72.0	3.78	308	2,761
EP7/52	7.5	3600	213T	91.0	89.0	8.67	153	1,256
EP7/525	7.5	3600	213T	91.0	89.0	6.94	153	1,256
EP7/54	7.5	1800	213T	91.7	86.5	8.85	175	1,261
EP7/545	7.5	1800	213T	91.7	86.5	7.08	175	1,261
EP7/56	7.5	1200	254T	91.0	80.5	9.59	268	2,073
EP7/565	7.5	1200	254T	91.0	80.5	7.67	268	2,073
EP7/58	7.5	900	254/256T	87.5	74.0	10.8	305	3,514
EP7/585	7.5	900	254/256T	87.5	74.0	8.6	305	3,514
EP0102	10	3600	213/215T	91.0	89.5	11.5	194	1,456
EP01025	10	3600	213/215T	91.0	89.5	9.2	194	1,456
EP0104	10	1800	213/215T	91.7	88.0	11.6	187	1,517
EP01045	10	1800	213/215T	91.7	88.0	9.28	187	1,517
EP0106	10	1200	254/256T	91.0	80.5	12.8	316	2,521
EP01065	10	1200	254/256T	91.0	80.5	10.2	316	2,521
EP0108	10	900	284T	90.2	73.5	14.1	425	4,429
EP01085	10	900	284T	90.2	73.5	11.3	425	4,429
EP0152	15	3600	254T	92.4	91.5	16.6	283	2,003
EP01525	15	3600	254T	92.4	91.5	13.3	283	2,003
EP0154	15	1800	254T	92.4	88.0	17.3	314	1,949
EP01545	15	1800	254T	92.4	88.0	13.8	314	1,949
EP0156	15	1200	284T	92.4	83.5	18.2	484	3,454
EP01565	15	1200	284T	92.4	83.5	14.6	484	3,454
EP0158	15	900	284/286T	90.2	78.0	20.0	548	5,809
EP01585	15	900	284/286T	90.2	78.0	16.0	548	5,809

AEHH8N, NEMA PREMIUM (1 HP - 400 HP) [EP]

Effective: 01-01-2022
Supersedes: 07-06-2021

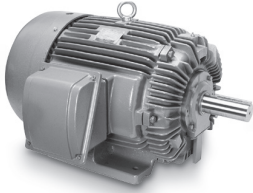

CATALOG NUMBER	HP	RPM	FRAME	FL EFF %	FL PF %	FL AMPS (460V or 575V)	APPROX. SHIPPING WT. (lbs.)	LIST PRICE (\$)
EP0202	20	3600	254/256T	92.4	92.5	21.9	371	2,547
EP02025	20	3600	254/256T	92.4	92.5	17.5	371	2,547
EP0204	20	1800	254/256T	93.0	87.5	23.0	367	2,457
EP02045	20	1800	254/256T	93.0	87.5	18.4	367	2,457
EP0206	20	1200	284/286T	91.7	84.0	24.3	500	4,355
EP02065	20	1200	284/286T	91.7	84.0	19.4	500	4,355
EP0208	20	900	324TX	91.0	81.0	25.4	560	7,002
EP02085	20	900	324TX	91.0	81.0	20.3	560	7,002
EP0252	25	3600	284TS	92.4	91.0	27.8	465	3,265
EP02525	25	3600	284TS	92.4	91.0	22.2	465	3,265
EP0254	25	1800	284T	93.6	86.0	29.1	487	2,997
EP02545	25	1800	284T	93.6	86.0	23.3	487	2,997
EP0254S	25	1800	284TS	93.6	86.0	29.1	487	2,997
EP02545S	25	1800	284TS	93.6	86.0	23.3	487	2,997
EP0256	25	1200	324T(X)	93.0	83.0	30.3	560	5,399
EP02565	25	1200	324T(X)	93.0	83.0	24.2	560	5,399
EP0258	25	900	324/326T(X)	91.0	80.0	32.2	569	8,277
EP02585	25	900	324/326T(X)	91.0	80.0	25.7	569	8,277
EP0302	30	3600	284/286TS	93.0	91.0	33.2	480	3,882
EP03025	30	3600	284/286TS	93.0	91.0	26.6	480	3,882
EP0304	30	1800	284/286T	93.6	87.5	34.3	535	3,686
EP03045	30	1800	284/286T	93.6	87.5	27.7	535	3,686
EP0304S	30	1800	284/286TS	93.6	87.5	34.3	535	3,686
EP03045S	30	1800	284/286TS	93.6	87.5	27.4	535	3,686
EP0306	30	1200	324/326T(X)	93.0	80.5	37.5	569	6,085
EP03065	30	1200	324/326T(X)	93.0	80.5	30.0	569	6,085
EP0308	30	900	364T	93.0	78.0	38.7	923	9,626
EP03085	30	900	364T	93.0	78.0	31.0	923	9,626
EP0402	40	3600	324TS(X)	94.1	90.0	44.2	566	5,071
EP04025	40	3600	324TS(X)	94.1	90.0	35.4	566	5,071
EP0404	40	1800	324T(X)	94.1	86.0	46.3	540	4,893
EP04045	40	1800	324T(X)	94.1	86.0	37.0	540	4,893
EP0404S	40	1800	324TS(X)	94.1	86.0	46.3	540	4,893
EP04045S	40	1800	324TS(X)	94.1	86.0	37.0	540	4,893
EP0406	40	1200	364T	94.1	86.5	46.0	880	7,981
EP04065	40	1200	364T	94.1	86.5	36.8	880	7,981
EP0408	40	900	364/365T	93.0	78.0	51.6	941	11,889
EP04085	40	900	364/365T	93.0	78.0	41.3	941	11,889

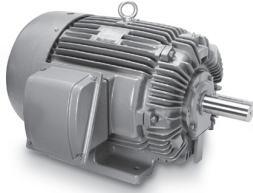

CATALOG NUMBER	HP	RPM	FRAME	FL EFF %	FL PF %	FL AMPS (460V or 575V)	APPROX. SHIPPING WT. (lbs.)	LIST PRICE (\$)
EP0502	50	3600	324/326TS(X)	94.1	91.0	54.7	629	6,761
EP05025	50	3600	324/326TS(X)	94.1	91.0	43.8	629	6,761
EP0504	50	1800	324/326T(X)	94.5	87.0	56.9	591	6,215
EP05045	50	1800	324/326T(X)	94.5	87.0	45.5	591	6,215
EP0504S	50	1800	324/326TS(X)	94.5	87.0	56.9	591	6,215
EP05045S	50	1800	324/326TS(X)	94.5	87.0	45.5	591	6,215
EP0506	50	1200	364/365T	94.1	86.0	57.8	966	9,845
EP05065	50	1200	364/365T	94.1	86.0	46.2	966	9,845
EP0506R	50	1200	364/365T	94.1	86.0	57.8	966	9,845
EP0508	50	1200	404T	93.0	81.0	62.1	1356	14,028
EP05085	50	1200	404T	93.0	81.0	49.7	1356	14,028
EP0602	60	3600	364TS	94.1	93.0	64.2	832	8,909
EP06025	60	3600	364TS	94.1	93.0	51.4	832	8,909
EP0604	60	1800	364T	95.0	86.5	68.4	878	8,029
EP06045	60	1800	364T	95.0	86.5	54.7	878	8,029
EP0604R	60	1800	364T	95.0	86.5	68.4	878	8,029
EP0604S	60	1800	364TS	95.0	86.5	68.4	878	8,029
EP06045S	60	1800	364TS	95.0	86.5	54.7	878	8,029
EP0606	60	1200	404T	94.5	87.0	68.3	1230	11,574
EP06065	60	1200	404T	94.5	87.0	54.6	1230	11,574
EP0606R	60	1200	404T	94.5	87.0	68.3	1230	11,574
EP0608	60	900	404/405T	93.0	81.0	74.6	1486	16,252
EP06085	60	900	404/405T	93.0	81.0	59.7	1486	16,252
EP0752	75	3600	364/365TS	94.5	93.0	79.9	926	11,379
EP07525	75	3600	364/365TS	94.5	93.0	63.9	926	11,379
EP0754	75	1800	364/365T	95.4	86.5	85.1	970	10,254
EP07545	75	1800	364/365T	95.4	86.5	68.1	970	10,254
EP0754S	75	1800	364/365TS	95.4	86.5	85.1	970	10,254
EP07545S	75	1800	364/365TS	95.4	86.5	68.1	970	10,254
EP0754R	75	1800	364/365T	95.4	86.5	85.1	970	10,254
EP07545R	75	1800	364/365T	95.4	86.5	68.1	970	10,254
EP0756	75	1200	404/405T	94.5	86.5	85.9	1346	13,782
EP07565	75	1200	404/405T	94.5	86.5	68.7	1346	13,782
EP0756R	75	1200	404/405T	94.5	86.5	85.9	1346	13,782
EP07565R	75	1200	404/405T	94.5	86.5	68.7	1346	13,782
EP0758	75	900	444T	93.6	79.0	95.0	1725	19,858
EP07585	75	900	444T	93.6	79.0	76.0	1725	19,858
EP0758R	75	900	444T	93.6	79.0	95.0	1725	19,858
EP07585R	75	900	444T	93.6	79.0	76.0	1725	19,858

AEHH8N, NEMA PREMIUM (1 HP - 400 HP) [EP]

Effective: 01-01-2022

Supersedes: 07-06-2021

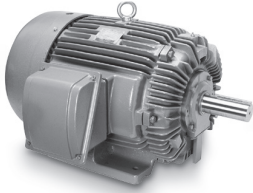

CATALOG NUMBER	HP	RPM	FRAME	FL EFF %	FL PF %	FL AMPS (460V or 575V)	APPROX. SHIPPING WT. (lbs.)	LIST PRICE (\$)
EP1002	100	3600	404/405TS	95.4	92.0	107	1350	15,432
EP10025	100	3600	404/405TS	95.4	92.0	85.6	1350	15,432
EP1004	100	1800	404/405T	95.4	87.5	112	1296	14,387
EP10045	100	1800	404/405T	95.4	87.5	89.6	1296	14,387
EP1004S	100	1800	404/405TS	95.4	87.5	112	1296	14,387
EP10045S	100	1800	404/405TS	95.4	87.5	89.6	1296	14,387
EP1004R	100	1800	404/405T	95.4	87.5	112	1296	14,387
EP10045R	100	1800	404/405T	95.4	87.5	89.6	1296	14,387
EP1006	100	1200	444T	95.0	82.5	119	1797	17,139
EP10065	100	1200	444T	95.0	82.5	95.2	1797	17,139
EP1006R	100	1200	444T	95.0	82.5	119	1797	17,139
EP10065R	100	1200	444T	95.0	82.5	95.2	1797	17,139
EP1008	100	900	444/445T	93.6	79.0	127	1954	25,793
EP10085	100	900	444/445T	93.6	79.0	102	1954	25,793
EP1008R	100	900	444/445T	93.6	79.0	127	1954	25,793
EP10085R	100	900	444/445T	93.6	79.0	102	1954	25,793
EP1252	125	3600	444TS	95.0	86.0	143	1712	18,570
EP12525	125	3600	444TS	95.0	86.0	114	1712	18,570
EP1254	125	1800	444T	95.4	85.0	144	1845	17,287
EP12545	125	1800	444T	95.4	85.0	115	1845	17,287
EP1254S	125	1800	444TS	95.4	85.0	144	1845	17,287
EP12545S	125	1800	444TS	95.4	85.0	115	1845	17,287
EP1254R	125	1800	444T	95.4	85.0	144	1845	17,287
EP12545R	125	1800	444T	95.4	85.0	115	1845	17,287
EP1256	125	1200	444/445T	95.0	83.0	148	2039	22,494
EP12565	125	1200	444/445T	95.0	83.0	118	2039	22,494
EP1256R	125	1200	444/445T	95.0	83.0	148	2039	22,494
EP12565R	125	1200	444/445T	95.0	83.0	118	2039	22,494
EP1258	125	900	445/447T	94.1	80.0	155	2293	29,660
EP12585	125	900	445/447T	94.1	80.0	124	2293	29,660
EP1258R	125	900	445/447T	94.1	80.0	155	2293	29,660
EP12585R	125	900	445/447T	94.1	80.0	124	2293	29,660

AEHH8N, NEMA PREMIUM (1 HP - 400 HP) [EP]

Effective: 01-01-2022
Supersedes: 07-06-2021

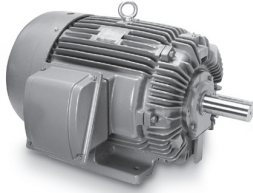

CATALOG NUMBER	HP	RPM	FRAME	FL EFF %	FL PF %	FL AMPS (460V or 575V)	APPROX. SHIPPING WT. (lbs.)	LIST PRICE (\$)
EP1502	150	3600	444/445TS	95.0	87.0	170	1829	22,238
EP15025	150	3600	444/445TS	95.0	87.0	136	1829	22,238
EP1504	150	1800	444/445T	95.8	85.0	172	1961	19,915
EP15045	150	1800	444/445T	95.8	85.0	138	1961	19,915
EP1504S	150	1800	444/445TS	95.8	85.0	172	1961	19,915
EP15045S	150	1800	444/445TS	95.8	85.0	138	1961	19,915
EP1504R	150	1800	444/445T	95.8	85.0	172	1961	19,915
EP15045R	150	1800	444/445T	95.8	85.0	138	1961	19,915
EP1506	150	1200	445/447T	95.8	83.5	176	2351	25,165
EP15065	150	1200	445/447T	95.8	83.5	141	2351	25,165
EP1506R	150	1200	445/447T	95.8	83.5	176	2351	25,165
EP15065R	150	1200	445/447T	95.8	83.5	141	2351	25,165
EP1508	150	900	447/449T	94.1	80.0	187	2134	35,623
EP15085	150	900	447/449T	94.1	80.0	150	2134	35,623
EP1508R	150	900	447/449T	94.1	80.0	187	2134	35,623
EP15085R	150	900	447/449T	94.1	80.0	150	2134	35,623
EP2002	200	3600	445/447TS	95.4	89.0	221	2172	30,458
EP20025	200	3600	445/447TS	95.4	89.0	177	2172	30,458
EP2004	200	1800	445/447T	96.2	87.0	224	2269	26,038
EP20045	200	1800	445/447T	96.2	87.0	179	2269	26,038
EP2004S	200	1800	445/447TS	96.2	87.0	224	2269	26,038
EP20045S	200	1800	445/447TS	96.2	87.0	179	2269	26,038
EP2004R	200	1800	445/447T	96.2	87.0	224	2269	26,038
EP20045R	200	1800	445/447T	96.2	87.0	179	2269	26,038
EP2006	200	1200	447/449T	95.8	84.0	233	2576	32,869
EP20065	200	1200	447/449T	95.8	84.0	186	2576	32,869
EP2006R	200	1200	447/449T	95.8	84.0	233	2576	32,869
EP20065R	200	1200	447/449T	95.8	84.0	186	2576	32,869
EP2008T	200	900	447/449T	94.5	80.0	248	2922	42,127
EP20085T	200	900	447/449T	94.5	80.0	198	2922	42,127
EP2008TR	200	900	447/449T	94.5	80.0	248	2922	42,127
EP20085TR	200	900	447/449T	94.5	80.0	198	2922	42,127

AEHH8N, NEMA PREMIUM (1 HP - 400 HP) [EP]

Effective: 01-01-2022
 Supersedes: 07-06-2021

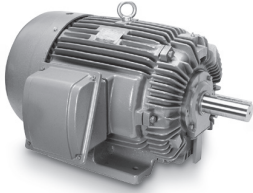

CATALOG NUMBER	HP	RPM	FRAME	FL EFF %	FL PF %	FL AMPS (460V or 575V)	APPROX. SHIPPING WT. (lbs.)	LIST PRICE (\$)
EP2502	250	3600	447/449TS	95.8	89.8	272	2594	39,695
EP25025	250	3600	447/449TS	95.8	89.8	218	2594	39,695
EP2504	250	1800	477/449T	96.2	88.0	277	2608	33,481
EP2504S	250	1800	477/449T	96.2	88.0	277	2608	33,481
EP25045	250	1800	477/449T	96.2	88.0	222	2608	33,481
EP2506	250	1200	477/449T	95.8	84.5	289	2777	34,423
EP2506S	250	1200	477/449T	95.8	84.5	231	2777	34,423
EP2506R	250	1200	477/449T	95.8	84.5	289	2777	34,423
EP2506SR	250	1200	477/449T	95.8	84.5	231	2777	34,423
EP3002	300	3600	447/449TS	95.8	90.2	325	2608	42,752
EP30025	300	3600	447/449TS	95.8	90.2	260	2608	42,752
EP3004	300	1800	447/449T	96.2	88.0	332	2850	35,060
EP3004S	300	1800	447/449T	96.2	88.0	266	2850	35,060
EP3004R	300	1800	447/449T	96.2	88.0	332	2850	35,060
EP3004SR	300	1800	447/449T	96.2	88.0	266	2850	35,060
EPS3006	300	1200	449T(X)	95.8	84.5	347	2708	36,101
EPS3006S	300	1200	449T(X)	95.8	84.5	278	2708	36,101
EPS3006R	300	1200	449T(X)	95.8	84.5	347	2708	36,101
EPS3006SR	300	1200	449T(X)	95.8	84.5	278	2708	36,101
EPS3502	350	3600	449TS(X)	95.8	90.2	379	3066	46,480
EPS3502S	350	3600	449TS(X)	95.8	90.2	303	3066	46,480
EPS3504	350	1800	449T(X)	96.2	88.0	387	3186	37,932
EPS3504S	350	1800	449T(X)	96.2	88.0	310	3186	37,932
EPS3504R	350	1800	449T(X)	96.2	88.0	387	3186	37,932
EPS3504SR	350	1800	449T(X)	96.2	88.0	310	3186	37,932
EPS4002	400	3600	449TS(X)	95.8	92.5	423	3197	47,240
EPS4002S	400	3600	449TS(X)	95.8	92.5	338	3197	47,240
EPS4004	400	1800	449T(X)	96.2	90.0	433	3342	51,064
EPS4004S	400	1800	449T(X)	96.2	90.0	346	3342	51,064

Notes:

1. To check stock or order 575V motors, add "5" to the end of Catalog Number, for example: "EP00545" for 5 HP, 1800 RPM, 575V.
2. Data subject to change without notice.

AEHH8NCF, NEMA PREMIUM, FOOTED C-FACE (1 HP - 300 HP) [EP_C]

AEUH8NDC, NEMA PREMIUM, ROUND BODY C-FACE (1 HP - 100 HP) [EPV_C]



Effective: 01-01-2022
 Supercedes: 07-06-2021

HP	RPM	FRAME	FL EFF %	FL PF %	FL AMPS (460V)	APPROX. SHIPPING WT. (lbs.)	FOOTED C-FACE		ROUND BODY C-FACE	
							CATALOG NUMBER	LIST PRICE (\$)	CATALOG NUMBER	LIST PRICE (\$)
1	3600	143TC	82.5	85.0	1.34	52	EP0012C	671	EPV0012C	717
1	1800	143TC	85.5	73.0	1.50	50	EP0014C	662	EPV0014C	737
1	1200	143/145TC	82.5	65.5	1.73	64	EP0016C	858	EPV0016C	812
1.5	3600	143TC	84.0	83.5	2.00	56	EP1/52C	725	EPV1/52C	769
1.5	1800	143/145TC	86.5	78.0	2.08	61	EP1/54C	759	EPV1/54C	786
1.5	1200	182TC	87.5	63.5	2.53	97	EP1/56C	892	EPV1/56C	1,031
2	3600	143/145TC	86.5	86.0	2.52	64	EP0022C	762	EPV0022C	911
2	1800	143/145TC	86.5	78.0	2.78	62	EP0024C	808	EPV0024C	923
2	1200	182/184TC	88.5	70.5	3.00	107	EP0026C	1,115	EPV0026C	1,150
3	3600	182TC	88.5	90.0	3.53	99	EP0032C	937	EPV0032C	1,069
3	1800	182TC	89.5	81.5	3.85	102	EP0034C	924	EPV0034C	1,075
3	1200	213TC	89.5	78.0	4.02	161	EP0036C	1,320	EPV0036C	1,667
5	3600	182/184TC	88.5	92.5	5.72	118	EP0052C	1,104	EPV0052C	1,261
5	1800	182/184TC	89.5	85.5	6.12	107	EP0054C	1,050	EPV0054C	1,200
5	1200	213/215TC	91.0	82.5	6.24	218	EP0056C	1,751	EPV0056C	1,999
7.5	3600	213TC	91.0	89.0	8.67	153	EP7/52C	1,492	EPV7/52C	1,704
7.5	1800	213TC	91.7	86.5	8.85	175	EP7/54C	1,497	EPV7/54C	1,712
7.5	1200	254TC	91.0	80.5	9.59	268	EP7/56C	2,314	EPV7/56C	2,645
10	3600	213/215TC	91.0	89.5	11.5	194	EP0102C	1,728	EPV0102C	1,977
10	1800	213/215TC	91.7	88.0	11.6	187	EP0104C	1,751	EPV0104C	1,999
10	1200	254/256TC	91.0	80.5	12.8	316	EP0106C	2,723	EPV0106C	3,464
15	3600	254TC	92.4	91.5	16.6	283	EP0152C	2,288	EPV0152C	2,614
15	1800	254TC	92.4	88.0	17.3	314	EP0154C	2,220	EPV0154C	2,538
15	1200	284TC	92.4	83.5	18.2	484	EP0156C	3,812	EPV0156C	4,355
20	3600	254/256TC	92.4	92.5	21.9	371	EP0202C	2,777	EPV0202C	3,409
20	1800	254/256TC	93.0	87.5	23.0	367	EP0204C	2,689	EPV0204C	3,426
20	1200	284/286TC	91.7	84.0	24.3	500	EP0206C	4,764	EPV0206C	5,172
25	3600	284TSC	92.4	91.0	27.8	465	EP0252C	3,744	EPV0252C	3,943
25	1800	284TC	93.6	86.0	29.1	487	EP0254C	3,525	EPV0254C	3,713
25	1200	324TC	93.0	83.0	30.3	560	EP0256C	5,923	EPV0256C	6,236
30	3600	286TSC	93.0	91.0	33.2	480	EP0302C	4,316	EPV0302C	4,545
30	1800	284/286TC	93.6	87.5	34.3	535	EP0304C	4,152	EPV0304C	4,372
30	1200	324/326TC	93.0	80.5	37.5	569	EP0306C	6,535	EPV0306C	6,880
40	3600	324TSC	94.1	90.0	44.2	566	EP0402C	5,650	EPV0402C	5,948
40	1800	324TC	94.1	86.0	46.3	540	EP0404C	5,445	EPV0404C	5,735
40	1200	364TC	94.1	86.5	46.0	880	EP0406C	8,646	EPV0406C	9,103
50	3600	324/326TSC	94.1	91.0	54.7	629	EP0502C	7,351	EPV0502C	7,741
50	1800	324/326TC	94.5	87.0	56.9	591	EP0504C	6,807	EPV0504C	7,167
50	1200	365TC	94.1	86.0	57.8	966	EP0506C	10,483	EPV0506C	11,039
60	3600	364TSC	94.1	93.0	64.2	832	EP0602C	9,530	EPV0602C	9,733
60	1800	364TC	95.0	86.5	68.4	878	EP0604C	8,780	EPV0604C	8,970
60	1200	404TC	94.5	87.0	68.3	1,230	EP0606C	12,660	EPV0606C	12,933
75	3600	365TSC	94.5	93.0	79.9	926	EP0752C	11,980	EPV0752C	12,237
75	1800	365TC	95.4	86.5	85.1	970	EP0754C	10,890	EPV0754C	11,124
75	1200	404/405TC	94.5	86.5	85.9	1,346	EP0756C	14,771	EPV0756C	15,089
100	3600	404/405TSC	95.4	92.0	107	1,350	EP1002C	16,199	EPV1002C	16,548
100	1800	404/405TC	95.4	87.5	112	1,296	EP1004C	15,246	EPV1004C	15,574
100	1200	444TC	95.0	82.5	119	1,797	EP1006C	17,737	EPV1006C	18,029
125	3600	444TSC	95.0	86.0	143	1,712	EP1252C	20,347	~	~
125	1800	444TC	95.4	85.0	144	1,845	EP1254C	19,527	~	~
125	1800	444TSC	95.4	85.0	144	1,845	EP1254CS	~	~	~
125	1200	444/445TC	95.0	83.0	148	2,039	EP1256C	22,091	~	~
150	3600	444/445TSC	95.0	87.0	170	1,829	EP1502C	23,571	~	~
150	1800	444/445TC	95.8	85.0	172	1,961	EP1504C	21,788	~	~
150	1800	445TSC	95.8	85.0	172	1,961	EP1504CS	21,788	~	~
150	1200	445/447TC	95.8	83.5	176	2,351	EP1506C	26,737	~	~
200	3600	445/447TSC	95.4	89.0	221	2,172	EP2002C	31,439	~	~
200	1800	445/447TC	96.2	87.0	224	2,269	EP2004C	27,723	~	~
200	1800	447TSC	96.2	87.0	224	2,269	EP2004CS	27,723	~	~
200	1200	447/449TC	95.8	84.0	233	2,576	EP2006C	33,422	~	~
250	3600	447/449TSC	95.8	89.8	272	2,594	EP2502C	39,286	~	~
250	1800	447/449TC	96.2	88.0	277	2,608	EP2504C	34,008	~	~
250	1800	449TSC	96.2	88.0	277	2,608	EP2504CS	~	~	~
250	1200	447/449TC	95.8	84.5	289	2,777	EP2506C	37,101	~	~
300	3600	447/449TSC	95.8	90.2	325	2,608	EP3002C	43,063	~	~
300	1800	447/449TC	96.2	88.0	332	2,850	EP3004C	35,416	~	~
300	1800	449TSC	96.2	88.0	332	2,850	EP3004CS	36,584	~	~

Notes:

1. To check stock or order 575V motors, add "5" to the end of Catalog Number, for example: "EP00545C" for 5 HP, 1800 RPM, 575V footed C-face.
2. Data subject to change without notice.
3. Footed C-Face Frame Size 140, BA dim = 2.25", Frame Size 180 BA dim = 2.75".
4. Various temp codes apply to round body ratings. Consult a stock product specialist for accurate code.

MAX-E1® VERTICAL ROUND BODY SOLID SHAFT NORMAL/MEDIUM THRUST with "P" BASE - LOW VOLTAGE



AEUH8NDP, NEMA PREMIUM, ROUND BODY (25 HP - 200 HP) [EPV_P]

Effective: 01-01-2022
Supersedes: 07-06-2021



APPLICATIONS:

- Centrifugal Pumps
- Petro-Chemical
- Water/ Wastewater
- Pulp and Paper

FEATURES:

- Output Range: 25 - 200 HP
- Speed: 1800 & 1200 RPM
- Enclosure: Totally Enclosed Fan Cooled (IP55)
- Voltage: 230/460V (Usable on 208V)¹
- Three Phase, 60 Hz, 1.15 Service Factor (Continuous); 50 Hz, 1.0 Service Factor (Continuous)
- CSA Certified for Class I, Div. 2, Groups B, C, D - Temp Code T3 Minimum
- Class F Insulation
- Class B Temperature Rise
- NEMA Design B Torques
- Cast Iron Frame, End Brackets, Fan Cover, Drip Cover and Main Conduit Box
- Cast Iron Fan Cover, Drip Cover 280 to 400 Frame, Rolled Steel Fan Cover, Drip Cover 440 Frames
- Grounding Terminal Inside Main Conduit Box
- Oversized Main Conduit Box Rotatable in 90 Degree Increments - F1 Mounted
- Designed for 40°C Ambient Temperature²
- Designed for 3300 ft. Elevation³
- Bi-Directional Rotation
- 1045 Carbon Steel Shaft, HP Mounting
- Aluminum Die Cast Squirrel Cage Rotor Construction
- Paint System: Phenolic Rust Proof Base Plus Polyurethane Top Coat
- Paint Color: Dark Gray - Munsell 7.5B 3.5/0.5
- Guide Bearings: Re-greasable Single Shielded with Mobil Polyrex™ EM
- Thrust Bearings: Re-Greasable Angular Contact with Mobil Polyrex™ EM
- Automatic Grease Discharge Fittings on Regreasable Models
- Double Contact Lip Seal on Both Ends
- Cast Iron Inner and Outer Bearing Caps
- Stainless Steel Nameplate
- Dual Column Design Nameplate as Standard (60/50 Hz)
- Suitable for Inverter Duty (PWM - Pulse Width Modulation) per NEMA MG-1, Part 31^{4,5}
- Inverter Duty Speed Range: 20:1 Variable Torque, 10:1 Constant Torque
- Motors are c U.L. us, c CSA us Approved
- 12 Leads on Motors up to 125HP, 6 Leads on 150HP and Larger
- NEMA Type P Base and HP Shaft

EXTRAS/ OPTIONS:

Please refer to pages 147 - 152 for common modifications that can be performed.

Notes:

1. Motors 7.5 HP & up are Suitable for Wye/Delta Starting.
2. Consult a Stock Product Application Specialist for suitability in higher ambient environments.
3. Consult a Stock Product Application Specialist for suitability at higher elevations.
4. Motor service factor is 1.0 when operated on a VFD.
5. Precautions should be taken to eliminate or reduce shaft currents that may be imposed on the motor by the VFD as stated per NEMA MG-1 Part 31.
6. HP Shaft is same as VP shaft dimensions per NEMA MG-1.

MAX-E1™ VERTICAL "P" BASE



AEUH8NDP, NEMA PREMIUM, ROUND BODY [EPV_P]

Effective: 01-01-2022
Supersedes: 07-06-2021



CATALOG NUMBER	HP	RPM	FRAME	FL EFF %	FL PF %	FL AMPS (460V)	DOWN THRUST (lbs.)	AG DIM. (in.)	APPROX. SHIPPING WT. (lbs.)	LIST PRICE (\$)
EPV0254P	25	1800	284/286HP	93.6	86.0	29.1	1295	29.1	441	3,831
EPV0256P	25	1200	324/326HP	93.0	83.0	30.3	1750	32.6	798	6,236
EPV0304P	30	1800	284/286HP	93.6	87.5	34.3	1295	30.6	490	4,491
EPV0306P	30	1200	324/326HP	93.0	80.5	37.5	1750	34.0	853	7,116
EPV0404P	40	1800	324/326HP	94.1	86.0	46.3	1395	32.6	682	5,969
EPV0406P	40	1200	364/365HP	94.1	86.5	46.0	2200	34.1	1,078	9,337
EPV0504P	50	1800	324/326HP	94.5	87.0	56.9	1395	32.1	744	7,402
EPV0506P	50	1200	364/365HP	94.1	86.0	57.8	2200	36.5	1,215	11,391
EPV0604P	60	1800	364/364HP	95.0	86.5	68.4	1800	36.5	1,078	9,205
EPV0606P	60	1200	404/405HP	94.5	87.0	68.3	2825	39.6	1,436	13,520
EPV0754P	75	1800	364/365HP	95.4	86.5	85.1	1800	36.5	1,215	11,360
EPV0756P	75	1200	404/405HP	94.5	86.5	85.9	2825	40.1	1,584	15,676
EPV1004P	100	1800	404/405HP	95.4	87.5	112	2300	40.1	1,584	15,810
EPV1006P	100	1200	444/445HP	95.0	82.5	119	1930	42.1	1,650	18,712
EPV1254P	125	1800	444/445HP	95.4	85.0	144	1530	42.1	1,650	17,167
EPV1256P	125	1200	444/445HP	95.0	83.0	148	1750	43.6	1,780	21,224
EPV1504P	150	1800	444/445HP	95.8	85.0	172	1530	43.6	1,780	19,156
EPV1506P	150	1200	445/447HP	95.8	83.5	176	2230	46.7	2,270	23,507
EPV2004P	200	1800	447/449HP	96.2	87.0	224	1530	37.8	2,270	24,376
EPV2006P	200	1200	447/449HP	95.8	84.0	233	1710	37.8	2,600	29,805

Notes:

1. Data subject to change without notice.

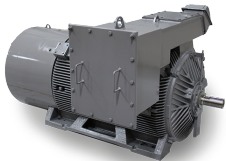

APPLICATIONS:

- Fans and Blowers
- Pumps
- Crushers
- Compressors
- Mixers
- Conveyors
- Any Severe-Duty/ Petro-Chem/ Pulp & Paper Application

FEATURES:

- Output Range: 200-1000 HP
- Speed: 3600, 1800, 1200 & 900 RPM
- Enclosure: Totally Enclosed Fan Cooled (IP55)
- Voltage: 460V¹
- Three Phase, 60 Hz, 1.15 Service Factor (Continuous); 50 Hz, 1.0 Service Factor (Continuous)
- CSA Certified for Class I, Div. 2, Groups A, B, C, D - Temp Code T2D Minimum⁶
- CSA Certified for Class II, Div. 2, Groups F & G - Temp Code T3C Minimum⁶
- Class F Insulation
- Class B Temperature Rise
- NEMA Design B Torques
- Cast Iron Frame, End Brackets & Pressed Steel Fan Cover and Plate Main Conduit Box.
- Oversized Fabricated Steel Main Conduit Box Rotatable in 90 Degree Increments Fully Gasketed with NPT Threaded Entrance - F1 Mounted, Field Convertible to F2 and F3
- Oversized Main Conduit Box Rotatable in 90 Degree Increments
- Designed for 40°C Ambient Temperature²
- Designed for 3300 ft. Elevation³
- Bi-Directional Rotation; Except 2 Pole are Counter-Clockwise facing the DE
- 1045 Carbon Steel Shaft
- Aluminum Die Cast Squirrel Cage Rotor Construction or Copper Bar Rotor Construction
- Paint System: Phenolic Rust Proof Base Plus Polyurethane Top Coat
- Paint Color: Light Gray - Munsell N5.0
- High Quality Ball (or Roller) Bearings Regreasable with Mobil Polyrex™ EM
- Automatic Grease Discharge Fittings
- Metal Flinger on Both Ends
- Cast Iron Inner and Outer Bearing Caps
- Stainless Steel Nameplate
- Dual Column Design Nameplate as Standard (60/50 Hz)
- 6 Leads
- Motors are CSA Approved
- Dual Drilled or Tri-Drilled Feet Available on Most Ratings - Longer Frames (i.e. 5009 Drilled also for 5007)
- Pre-Formed Random Wound, Made of High Pulse Endurance Index Wire, CIV Tested to 2000V/0.1us
- Suitable for Inverter Use per NEMA MG-1 Part 31.4.4.2^(4,5)
- Inverter Duty Speed Range: 10:1 Variable Torque, 3:1 Constant Torque
- 2-Pole Motors 400 HP and Larger Standard Features: 100 Ohm Platinum Stator RTD's(2/Phase), Space Heaters(120V), and Insulated Non-Drive End Bearings
- Catalog Numbers Ending in "R" Come Standard with Roller Bearings for Belted Applications.
- Spotface ¼ -28UNF Tap x 12mm Deep on Top of Both End Brackets with VB300 Vibration Sensor on 5000 Frames and Larger

EXTRAS/ OPTIONS:

Please refer to pages 147 - 152 for common modifications that can be performed.

Notes:

1. TWMC carries minimal MAX-E1® 575V stock; please check availability to ensure required motors are available. Ratings may be available from our Canadian warehouses at a higher price or from our factory with a longer lead time. Pricing and lead time may vary.
2. Consult a Stock Product Application Specialist for suitability in higher ambient environments.
3. Consult a Stock Product Application Specialist for suitability at higher elevations.
4. Motor service factor is 1.0 when operated on a VFD.
5. Precautions should be taken to eliminate or reduce shaft currents that may be imposed on the motor by the VFD as stated per NEMA MG-1. Part 31.
6. Various temp codes apply to ratings. Consult a stock product specialist for accurate code.
7. Insulated bearings on the NDE will be standard for the following Catalog #'s EPF4002, EPF5002, EPF6002, EPF7002, and EPF8002.
8. F# 5000 and with Larger with Pressed Steel Plate Main Conduit Box.
9. F# 5007 - 5011 8 Pole Ratings are Aluminum Die Cast Squirrel Cage Rotor Construction.

AFHH, TEFC, NEMA PREMIUM, F3 CONVERTIBLE 200 HP - 1000 HP [EPF]

Effective: 01-01-2022
Supersedes: 07-06-2021

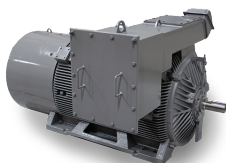

CATALOG NUMBER	HP	RPM	FRAME	FL EFF %	FL PF %	FL AMPS (460V)	APPROX. SHIPPING WT. (lbs.)	LIST PRICE (\$)
EPF2008	200	900	5007/9B	94.5	79.4	250	3700	54,706
EPF2008R	200	900	5007/9C	94.5	79.4	250	3700	54,706
EPF2508	250	900	5007/9B	95.0	79.9	309	3900	55,383
EPF2508R	250	900	5007/9C	95.0	79.9	309	3900	55,383
EPF3006	300	1200	5007/9B	95.8	80.6	364	3900	52,501
EPF3008	300	900	5007/9B	95.0	81.1	365	4100	56,440
EPF3008R	300	900	5007/9C	95.0	81.1	365	4100	56,440
EPF3502	350	3600	5007/9A	95.8	89.3	383	3600	50,389
EPF3504	350	1800	5007/9B	96.2	88.2	386	3700	51,983
EPF3506	350	1200	5007/9B	95.8	80.8	423	4100	54,083
EPF3508	350	900	5007/9B	95.0	81.2	425	4300	68,646
EPF3508R	350	900	5007/9C	95.0	81.2	425	4300	68,646
EPF4002	400	3600	5007/9A	96.9	89.7	431	3700	51,192
EPF4004	400	1800	5007/9B	96.2	88.4	440	3900	53,411
EPF4006	400	1200	5009/10/11B	95.8	79.8	490	4600	66,379
EPF4006R	400	1200	5009/10/11C	95.8	79.8	490	4600	66,379
EPF4008	400	900	5009/10/11B	95.1	80.9	487	4900	77,302
EPF4008R	400	900	5009/10/11C	95.1	80.9	487	4900	77,302
EPF4502	450	3600	5007/9A	96.0	90.0	487	3900	55,552
EPF4504	450	1800	5007/9B	96.2	88.7	494	4100	56,183
EPF4504R	450	1800	5007/9C	96.2	88.7	494	4100	56,183
EPF4506	450	1200	5009/10/11B	95.9	81.4	539	4800	71,400
EPF4506R	450	1200	5009/10/11C	95.9	81.4	539	4800	71,400
EPF4508	450	900	5009/10/11B	95.1	80.6	550	5100	81,627
EPF4508R	450	900	5009/10/11C	95.1	80.6	550	5100	81,627
EPF5002	500	3600	5009/10/11A	96.1	90.4	539	4300	62,080
EPF5004	500	1800	5009/10/11B	96.2	87.3	557	4500	61,709
EPF5004R	500	1800	5009/10/11C	96.2	87.3	557	4500	61,709
EPF5006	500	1200	5009/10/11B	96.1	80.8	603	5000	77,492
EPF5006R	500	1200	5009/10/11C	96.1	80.8	603	5000	77,492
EPF5008	500	900	5810B	95.2	82.6	595	6600	102,909
EPF5008R	500	900	5810C	95.2	82.6	595	6600	102,909
EPF6002	600	3600	5009/10/11A	96.1	90.9	643	4600	79,277
EPF6004	600	1800	5009/10/11B	96.3	88.7	658	4800	69,128
EPF6004R	600	1800	5009/10/11C	96.3	88.7	658	4800	69,128
EPF6006	600	1200	5009/10/11B	96.4	84.5	689	5300	88,432
EPF6006R	600	1200	5009/10/11C	96.4	84.5	689	5300	88,432

Notes:

1. To check stock or order 575V motors, add "5" to the end of Catalog Number, for example: "EPF20085" for 200 HP, 900 RPM, 575V.
2. Ratings above 500 HP do not have a NEMA Premium requirement, however do meet NEMA Premium Standards.
3. Data subject to change without notice.

AFHH, TEFC, NEMA PREMIUM, F3 CONVERTIBLE
200 HP - 1000 HP [EPF]

Effective: 01-01-2022
 Supersedes: 07-06-2021

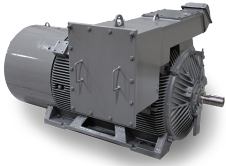

CATALOG NUMBER	HP	RPM	FRAME	FL EFF %	FL PF %	FL AMPS (460V)	APPROX. SHIPPING WT. (lbs.)	LIST PRICE (\$)
EPF6008	600	900	5810B	95.5	81.2	725	6700	116,536
EPF6008R	600	900	5810C	95.5	81.2	725	6700	116,536
EPF7002	700	3600	5009/10/11A	96.1	90.1	757	4900	88,082
EPF7004	700	1800	5009/10/11B	96.5	87.8	774	5200	86,667
EPF7004R	700	1800	5009/10/11C	96.5	87.8	774	5200	86,667
EPF7006	700	1200	5810B	95.8	86.9	787	6,300	105,495
EPF7006R	700	1200	5810C	95.8	86.9	787	6,300	105,495
EPF7008	700	900	5810B	95.6	81.5	841	7,200	124,419
EPF7008R	700	900	5810C	95.6	81.5	841	7,200	124,419
EPF8002	800	3600	5810A	96.4	91.5	849	6,300	101,492
EPF8004	800	1800	5810B	96.0	88.2	885	6,600	100,670
EPF8004R	800	1800	5810C	96.0	88.2	885	6,600	100,670
EPF8006	800	1200	5810B	96.0	86.9	898	6,600	112,264
EPF8006R	800	1200	5810C	96.0	86.9	898	6,600	112,264
EPF9004	900	1800	5810B	96.0	88.4	993	7,000	108,708
EPF9004R	900	1800	5810C	96.0	88.4	993	7,000	108,708
EPF9006	900	1200	5810B	96.0	87.4	1005	7,200	123,789
EPF9006R	900	1200	5810C	96.0	87.4	1005	7,200	123,789
EPF10004	1000	1800	5810B	96.0	88.1	1107	7,000	115,120
EPF10004R	1000	1800	5810C	96.0	88.1	1107	7,000	115,120

Notes:

1. To check stock or order 575V motors, add "5" to the end of Catalog Number, for example: "EPF20085" for 200 HP, 900 RPM, 575V.
2. Ratings above 500 HP do not have a NEMA Premium requirement, however do meet NEMA Premium Standards.
3. Data subject to change without notice.

KEYLESS SHAFT MOTOR



AEHHSY, NEMA PREMIUM (200 HP - 500 HP) [EPY]

AEHESY, HIGH EFFICIENCY (600 HP - 800 HP) [EY]

Effective: 01-01-2022

Supersedes: 07-06-2021

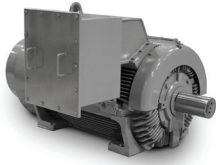

APPLICATIONS:

- Fans and Blowers
- Compressors
- Any Severe Duty/ Petro-Chem/ Pulp & Paper Application
- Pumps
- Mixers

FEATURES:

- Output Range: 200 - 800 HP
- Speed: 1800, 1200, 900 RPM
- Enclosure: Totally Enclosed Fan Cooled (IP55)
- Voltage: 460V Only
- Three Phase, 60 Hz, 1.15 Service Factor (Continuous); 50 Hz, 1.0 Service Factor (Continuous)
- CSA Certified for Class I, Div. 2, Groups B, C, D - Temp Code T3 Minimum³
- CSA Certified for Class II, Div. 2, Groups F & G - Temp Code T3 Minimum³
- Class F Insulation
- Class B Temperature Rise
- NEMA Design B Torques
- Cast Iron Frame, End Brackets & Fan Cover and Main Conduit Box⁽⁶⁾
- Grounding Terminal Inside Main Conduit Box
- Oversized Main Conduit Box Rotatable in 90 Degree Increments - F1 Mounted
- Designed for 40°C Ambient Temperature¹
- Designed for 3300 ft. Elevation²
- Bi-Directional Rotation
- 4140 SCM Carbon Steel Shaft-Keyless
- Aluminum Die Cast Squirrel Cage Rotor Construction or Copper/Copper Alloy Rotor Construction. See product page for more details.
- Paint System: Phenolic Rust Proof Base Plus Polyurethane Top Coat
- Paint Color: Light Gray - Munsell N5.0
- High Quality Ball (or Roller) Bearings Regreasable with Mobil Polyrex™ EM
- Automatic Grease Discharge Fittings
- Metal Flinger on Both Ends
- Cast Iron Inner and Outer Bearing Caps
- Stainless Steel Nameplate
- Dual Column Design Nameplate as Standard (60/50 Hz) on the 449 Frames and below
- Suitable for Inverter Use per NEMA MG-1 Part 31.4.4.2^(4,5)
- Inverter Duty Speed Range: 20:1 Variable Torque, 10:1 Constant Torque (350 HP and Larger are 3:1 Constant Torque)
- 6 Leads
- Motors are U.L. Recognized, CSA Approved
- Provisions for Bearing RTDs, both End Brackets Pre-Drilled and Plugged; F#5000 and Larger Only
- Spotface ¼ -28UNF Tap x 12mm Deep on Top of Both End Brackets with VB300 Vibration Sensor

EXTRAS/ OPTIONS:

Please refer to pages 147 - 152 for common modifications that can be performed.

Notes:

1. Consult a Stock Product Application Specialist for suitability in higher ambient environments.
2. Consult a Stock Product Application Specialist for suitability at higher elevations.
3. CSA Certification for Hazardous Locations only applies to select ratings. See product page for select details.
4. Motor service factor is 1.0 when operated on a VFD.
5. Precautions should be taken to eliminate or reduce shaft currents that may be imposed on the motor by the VFD as stated per NEMA MG-1, Part 31.
6. F# 5000 and Larger with Pressed Steel Plate Main Conduit Box.

KEYLESS SHAFT MOTOR



AEHHSY, NEMA PREMIUM (200 HP - 500 HP) [EPY]

Effective: 01-01-2022
Supersedes: 07-06-2021

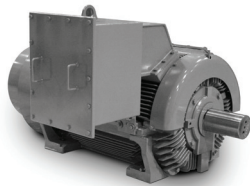

CATALOG NUMBER	HP	RPM	FRAME	FL EFF %	FL PF %	FL AMPS (460V)	SHAFT DIAMETER (in.)	APPROX. SHIPPING WT. (lbs.)	LIST PRICE (\$)
EPY2006 ^{1,3}	200	1200	447/449TY	95.8	84.0	233	3.875	2,685	53,723
EPY2008 ^{1,3}	200	900	447/449TY	94.5	80.0	248	3.875	3,090	48,507
EPY2504 ^{1,3}	250	1800	447/449TY	96.2	88.0	277	3.875	2,720	35,182
EPY2506 ^{1,3}	250	1200	447/449TY	95.8	84.5	289	3.875	3,250	54,356
EPY2508 ^{1,2,3}	250	900	5009UZ	95.0	81.0	304	5.000	3,920	57,178
EPY3004 ^{1,3}	300	1800	447/449TY	96.2	88.0	332	3.875	2,855	36,761
EPY3006 ^{1,3}	300	1200	447/449TY	95.8	84.5	347	3.875	3,300	60,573
EPY3008 ^{1,2,3}	300	900	5009UZ	95.0	81.0	365	5.000	4,410	73,399
EPY3504 ^{1,3}	350	1800	447/449TY	96.2	88.0	387	3.875	3,500	39,634
EPY3506 ^{1,2,3}	350	1200	5010/5011UZ	95.8	87.0	393	5.000	4,950	67,029
EPY3508 ^{1,2,3}	350	900	5010/5011UZ	95.0	81.0	426	5.000	5,040	87,600
EPY4004 ^{1,2,3}	400	1800	5009UZ	96.2	90.0	433	5.000	4,025	60,775
EPY4006 ^{1,2,3}	400	1200	5010/5011UZ	95.8	87.0	449	5.000	4,950	76,528
EPY4008 ^{1,2,3}	400	900	5808UZ	95.0	82.5	478	5.750	5,590	102,356
EPY4504 ^{1,2,3}	450	1800	5010/5011UZ	96.2	90.0	487	5.000	5,040	71,847
EPY4506 ^{1,2,3}	450	1200	5808UZ	95.8	88.0	500	5.750	5,550	107,611
EPY4508 ^{1,2,3}	450	900	5808UZ	95.0	82.5	538	5.750	6,320	124,021
EPY5004 ^{1,2,3}	500	1800	5010/5011UZ	96.2	90.0	541	5.000	5,300	88,035
EPY5006 ^{1,2,3}	500	1200	5808UZ	95.8	88.0	555	5.750	5,900	114,619
EPY5008 ^{1,2,3}	500	900	5810UZ	95.0	83.0	594	5.750	6,950	133,197

Notes:

1. Noted ratings CSA Certified for Hazardous Locations Class 1 Div 2, Class 2 Div 2.
2. Noted ratings with Copper/Copper Alloy Rotor Construction.
3. Data subject to change without notice.

KEYLESS SHAFT MOTOR

AEHESY, HIGH EFFICIENCY (600 HP - 800 HP) [EY]

Effective: 01-01-2022

Supersedes: 07-06-2021

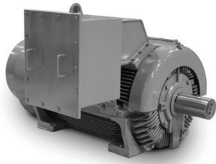

CATALOG NUMBER	HP	RPM	FRAME	FL EFF %	FL PF %	FL AMPS (460V)	SHAFT DIAMETER (in.)	APPROX. SHIPPING WT. (lbs.)	LIST PRICE (\$)
EY6004	600	1800	5808UZ	95.5	90.0	654	5.75	6,250	111,223
EY6006	600	1200	5810UZ	95.6	86.8	677	5.75	6,550	133,844
EY6008	600	900	6808UZ	95.5	84.0	700	5.75	8,600	148,963
EY7004	700	1800	5810UZ	95.6	90.0	762	5.75	7,350	130,202
EY7006	700	1200	5810UZ	95.8	86.8	788	5.75	7,450	153,491
EY7008	700	900	6808UZ	95.6	84.0	816	5.75	9,050	~
EY8004	800	1800	5810UZ	95.6	90.5	866	5.75	7,800	139,242
EY8006	800	1200	6808UZ	96.0	87.0	897	5.75	8,550	166,846
EY8008	800	900	6808UZ	95.6	84.0	933	5.75	9,400	171,289

Notes:

1. Noted ratings CSA Certified for Hazardous Locations Class 1 Div 2.
2. Noted ratings with Copper/Copper Alloy Rotor Construction.
3. Data subject to change without notice.

MAX-E2/841® LITE



AEHH, NEMA PREMIUM (1 HP - 300 HP) [HH]

Effective: 01-01-2022
Supersedes: 07-06-2021

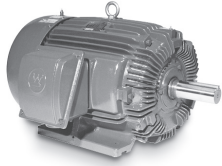

APPLICATIONS:

- | | | |
|------------------|---------------|----------------------------|
| ■ Fans & Blowers | ■ Compressors | ■ Severe Duty/ Petro-Chem |
| ■ Pumps | ■ Mixers | ■ Pulp & Paper Application |
| ■ Crushers | ■ Conveyors | ■ Marine Duty |

FEATURES:

- Output Range: 1 - 300 HP
- Speed: 3600, 1800 & 1200 RPM
- Enclosure: Totally Enclosed Fan Cooled (IP55)
- Voltage: 460V Only
- Three Phase, 60 Hz, 1.15 Service Factor (Continuous); 50 Hz, 1.0 Service Factor (Continuous)
- CSA Certified for Class I, Div. 2, Groups B, C, D - Temp Code T3 Minimum
- CSA Certified for Class II, Div. 2, Groups F & G - Temp Code T3 Minimum⁵ (444T and above)
- IEEE 841 Ready
- Meets IEEE 45 Marine Duty
- Class F Insulation
- Class B Temperature Rise
- NEMA Design B Torques as a Minimum; Various Ratings also Meet Design C
- Cast Iron Frame, End Brackets & Fan Cover and Main Conduit Box
- Grounding Terminal Inside Main Conduit Box with additional Foot Grounding Provision
- Oversized Main Conduit Box Rotatable in 90 Degree Increments - F1 Mounted
- Designed for 40°C Ambient Temperature¹
- Designed for 3300 ft. Elevation²
- Bi-Directional Rotation
- 1045 Carbon Steel Shaft
- Aluminum Die Cast Squirrel Cage Rotor Construction
- Paint System: 2 Part Epoxy
- Paint Color: Blue - Munsell 5PB 3/8
- High Quality Ball (or Roller) Bearings Regreasable with Mobil Polyrex™ EM
- Automatic Grease Discharge Fittings
- Rubber Dust Flinger on DE for F# 140T - 280T
- Oil Seal/V-Ring on Both Ends for F# 320T - 400T
- Metal Flinger on Both Ends
- Cast Iron Inner and Outer Bearing Caps for F# 400T and Larger
- Stainless Steel Nameplate and Hardware
- Stainless Steel Automatic Breather Drain
- Dual Column Design Nameplate as Standard (60/50 Hz)
- Suitable for Inverter Use per NEMA MG-1 Part 31.4.4.2^(3,4)
- Inverter Duty Speed Range: 20:1 Variable Torque, 10:1 Constant Torque (350 HP and Larger are 3:1 Constant Torque)
- Motors are U.L. Recognized, CSA Approved
- 3 Leads Only
- Dual Drilled Feet Available on Most Ratings - Longer Frames (i.e.145T Drilled also for 143T)
- Vibration Not to Exceed 0.08 Inches Per Second
- Noise Level Not to Exceed 85 dB(A) at 1 Meter Unloaded

EXTRAS/ OPTIONS:

Please refer to pages 147 - 152 for common modifications that can be performed.

Notes:

1. Consult a Stock Product Application Specialist for suitability in higher ambient environments.
2. Consult a Stock Product Application Specialist for suitability at higher elevations.
3. Motor service factor is 1.0 when operated on a VFD.
4. Precautions should be taken to eliminate or reduce shaft currents that may be imposed on the motor by the VFD as stated per NEMA MG-1. Part 31.
5. Various temp codes apply to ratings. Consult a stock product specialist for accurate code.

MAX-E2/841® LITE



AEHH, NEMA PREMIUM [HH]

Effective: 01-01-2022
Supercedes: 07-06-2021



CATALOG NUMBER	HP	RPM	FRAME	FL EFF %	FL PF %	FL AMPS (460V)	SHIPPING WT. (lbs.)	LIST PRICE (\$)
HH0012	1	3600	143T	85.0	82.5	1.34	58	635
HH0014	1	1800	143T	73.0	85.5	1.50	58	609
HH0016	1	1200	145T	65.5	82.5	1.73	97	758
HH1/52	2	3600	143T	83.5	84.0	2.00	58	658
HH1/54	2	1800	145T	78.0	86.5	2.08	65	698
HH1/56	2	1200	182T	63.5	87.5	2.53	130	783
HH0022	2	3600	145T	86.0	86.5	2.52	78	712
HH0024	2	1800	145T	78.0	86.5	2.78	97	744
HH0026	2	1200	184T	70.5	88.5	3.00	150	898
HH0032	3	3600	182T	90.0	88.5	3.53	100	964
HH0034	3	1800	182T	84.0	89.5	3.74	130	856
HH0036	3	1200	213T	78.0	89.5	4.02	220	1,476
HH0052	5	3600	184T	92.5	88.5	5.72	140	1,037
HH0054	5	1800	184T	85.5	89.5	6.12	150	990
HH0056	5	1200	215T	82.5	91.0	6.24	235	1,694
HH7/52	7.5	3600	213T	89.0	91.0	8.67	202	1,397
HH7/54	7.5	1800	213T	86.5	91.7	8.85	202	1,404
HH7/56	7.5	1200	254T	80.5	91.0	9.59	323	2,285
HH0102	10	3600	215T	89.5	91.0	11.5	224	1,627
HH0104	10	1800	215T	88.0	91.7	11.6	224	1,985
HH0106	10	1200	256T	80.5	91.0	12.8	380	2,791
HH0152	15	3600	254T	91.5	92.4	16.6	323	2,216
HH0154	15	1800	254T	88.0	92.4	17.3	345	2,156
HH0156	15	1200	284T	83.5	92.4	18.2	540	3,754
HH0202	20	3600	256T	92.5	92.4	21.9	367	2,782
HH0204	20	1800	256T	87.5	93.0	23.0	425	2,717
HH0206	20	1200	286T	84.0	91.7	24.3	565	4,651
HH0252	25	3600	284TS	91.0	92.4	27.8	490	3,458
HH0254	25	1800	284T	86.0	93.6	29.1	555	3,253
HH0256	25	1200	324T	83.0	93.0	30.3	759	5,616
HH0302	30	3600	286TS	91.0	93.0	33.2	535	4,066
HH0304	30	1800	286T	87.5	93.6	34.3	656	4,019
HH0306	30	1200	326T	80.5	93.0	37.5	795	6,421
HH0402	40	3600	324TS	90.0	94.1	44.2	755	5,336
HH0404	40	1800	324T	86.0	94.1	46.3	740	5,146
HH0406	40	1200	364T	86.5	94.1	46.0	898	8,577
HH0502	50	3600	326TS	91.0	94.1	54.7	782	6,931
HH0504	50	1800	326T	87.0	94.5	56.9	845	6,318
HH0506	50	1200	365T	86.0	94.1	57.8	1,110	10,209
HH0602	60	3600	364TS	93.0	94.1	64.2	853	9,386
HH0604	60	1800	364T	86.5	95.0	68.4	955	9,056
HH0606	60	1200	404T	87.0	94.5	68.3	1,355	12,185
HH0752	75	3600	365TS	93.0	94.5	79.9	1,015	11,688
HH0754	75	1800	365T	86.5	95.4	85.1	1,040	11,362
HH0756	75	1200	405T	86.5	94.5	85.9	1,363	14,078
HH1002	100	3600	405TS	92.0	95.4	107	1,330	15,881
HH1004	100	1800	405T	87.5	95.4	112	1,385	14,652
HH1006	100	1200	444T	82.5	95.0	119	1,833	18,963
HH1252	125	3600	444TS	86.0	95.0	143	1,783	20,081
HH1254	125	1800	444T	84.0	95.4	146	1,833	18,646
HH1256	125	1200	445T	83.0	95.0	148	1,961	23,394
HH1502	150	3600	445TS	87.0	95.0	170	1,808	24,065
HH1504	150	1800	445T	84.0	95.8	175	2,037	21,714
HH1506	150	1200	447T	83.5	95.8	176	2,400	26,183
HH2002	200	3600	447TS	87.0	95.4	226	2,317	31,133
HH2004	200	1800	447T	84.5	96.2	230	2,426	26,926
HH2006	200	1200	449T	84.0	95.8	233	2,801	33,770
HH2502	250	3600	449TS	88.0	95.8	278	2,725	40,359
HH2504	250	1800	449T	85.5	96.2	285	2,710	34,333
HH2506	250	1200	449T	84.5	95.8	289	3,080	43,506
HH3002	300	3600	449TS	88.0	95.8	333	2,928	48,362
HH3004	300	1800	449T	85.5	96.2	342	2,980	41,421

Notes:

1. 575V not offered as stock for this product line.
2. Data subject to change without notice.

MAX-E2/841® FAMILY



AEHH8B, NEMA PREMIUM (1 HP - 500 HP) [HB]

AEHH8BCF, NEMA PREMIUM, FOOTED C-FACE (1 HP - 100 HP) [HB_C]

AEUH8BDC, NEMA PREMIUM, ROUND BODY C-FACE (1 HP - 100 HP) [HBV_C]

Effective: 01-01-2022
Supersedes: 07-06-2021



APPLICATIONS:

- | | | |
|------------------|---------------|----------------------------|
| ■ Fans & Blowers | ■ Compressors | ■ Severe Duty/ Petro-Chem |
| ■ Pumps | ■ Mixers | ■ Pulp & Paper Application |
| ■ Crushers | ■ Conveyors | ■ Marine Duty |

FEATURES:

- Output Range: 1 - 500 HP
- Speed: 3600, 1800, 1200, 900 RPM
- Enclosure: Totally Enclosed Fan Cooled (IP55)¹¹
- Voltage: 460V Only¹
- Meets GM 7E-TA Specifications
- Three Phase, 60 Hz, 1.15 Service Factor (Continuous); 50 Hz, 1.0 Service Factor (Continuous)
- CSA Certified for Class I, Div. 2, Groups B, C, D - Temp Code T3 Minimum^{6,7}
- CSA Certified for Class II, Div. 2, Groups F & G - Temp Code T3 Minimum (Frame 444T and Above)^{6,7}
- Meets or Exceeds IEEE 841 Standards
- Meets IEEE 45 Marine Duty and ABS Design Assessment up to 500 HP(2,4,6 pole only)⁽¹⁰⁾
- Extended Warranty - 60 Months from Date of Manufacture
- Class F Insulation
- Class B Temperature Rise
- NEMA Design B Torques as a Minimum; Various Ratings also Meet Design C
- Cast Iron Frame, End Brackets & Fan Cover and Main Conduit Box⁸
- Grounding Terminal Inside Main Conduit Box with additional Foot Grounding Provision
- Oversized Main Conduit Box Rotatable in 90 Degree Increments - F1 Mounted
- Designed for 50°C Ambient Temperature²
- Designed for 3300 ft. Elevation³
- Bi-Directional Rotation; Except 2 Pole "Hybrid" and F# 5000 and Larger Ratings are Counter-Clockwise facing the DE
- 1045 Carbon Steel Shaft
- Aluminum Die Cast Squirrel Cage Rotor Construction for F# 140T - 449T
- Copper/Copper Alloy Rotor Construction for F# 5000 and Larger⁹
- Epoxy Coated Rotor.
- Paint System: 2 Part Epoxy
- Paint Color: Blue - Munsell 5PB 3/8
- High Quality Ball (or Roller) Bearings Regreasable with Mobil Polyrex™ EM
- Automatic Grease Discharge Fittings for horizontal or vertical mounting
- VBXX INPRO™ Seals are IP66 rate and are Installed on Both Ends
- Stainless Steel Nameplate and Hardware
- Stainless Steel Automatic Breather Drain
- Dual Column Design Nameplate as Standard (60/50 Hz)
- Suitable for Inverter Use per NEMA MG-1 Part 31.4.4.2^(4,5)
- Inverter Duty Speed Range: 20:1 Variable Torque, 10:1 Constant Torque (350 HP and Larger are 3:1 Constant Torque)
- Motors are U.L. Recognized, CSA Approved
- 3 Leads Only
- Dual Drilled Feet Available on Most Ratings - Longer Frames (i.e. 145T Drilled also for 143T)
- Vibration Not to Exceed 0.08 Inches Per Second
- Noise Level Not to Exceed 85 dB(A) at 1 Meter Unloaded

EXTRAS/ OPTIONS:

Please refer to pages 147 - 152 for common modifications that can be performed.

Notes:

1. TWMC carries minimal MAX-E2® 575V stock; please check availability to ensure required motors are available. Ratings may be available from our Canadian Warehouses at a higher price or from our factory with a longer lead time. Pricing and lead time may vary.
2. Consult a Stock Product Application Specialist for suitability in higher ambient environments.
3. Consult a Stock Product Application Specialist for suitability at higher elevations.
4. Motor service factor is 1.0 when operated on a VFD.
5. Precautions should be taken to eliminate or reduce shaft currents that may be imposed on the motor by the VFD as stated per NEMA MG-1. Part 31.
6. Catalog# HB3502 & HB3504 are "Hybrid" ratings; Not CSA Certified (Self-Certify Only) for hazardous locations, and not dual drilled.
 - a.) Self Certification available upon request at an additional fee
7. Catalog# HB3006 also not CSA Certified for hazardous locations (Self-Certify Only). Self Certification available upon request at an additional fee.
8. F# 5000 and with Larger with Pressed Steel Plate Main Conduit Box.
9. F# 5007 - 5011 8 Pole Ratings are Aluminum Die Cast Squirrel Cage Rotor Construction.
10. Contact Application Engineering for ABS Motor Pricing
11. To convert to IP65, the M17 Modification is required; to convert to IP66, the M31 Modification is required.

MAX-E2/841®



AEHH8B, NEMA PREMIUM [HB]

Effective: 01-01-2022
Supersedes: 07-06-2021

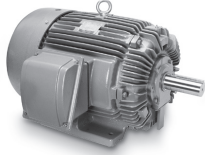

CATALOG NUMBER	HP	RPM	FRAME	FL EFF %	FL PF %	FL AMPS (460V)	APPROX. SHIPPING WT. (lbs.)	LIST PRICE (\$)
HB0012	1	3600	143T	82.5	85.0	1.34	58	1,208
HB0014	1	1800	143T	85.5	73.0	1.50	58	1,157
HB0016	1	1200	143/145T	82.5	65.5	1.73	97	1,262
HB0018	1	900	182T	77.0	58.5	2.08	115	1,524
HB1/52	1.5	3600	143T	84.0	83.5	2.00	58	1,213
HB1/54	1.5	1800	143/145T	86.5	78.0	2.08	65	1,209
HB1/56	1.5	1200	182T	87.5	63.5	2.53	130	1,396
HB1/58	1.5	900	182/184T	78.5	60.5	3.01	125	1,704
HB0022	2	3600	143/145T	86.5	86.0	2.52	78	1,219
HB0024	2	1800	143/145T	86.5	78.0	2.78	97	1,227
HB0026	2	1200	182/184T	88.5	70.5	3.00	150	1,537
HB0028	2	900	213T	85.5	64.0	3.42	173	2,260
HB0032	3	3600	182T	88.5	90.0	3.53	100	1,439
HB0034	3	1800	182T	89.5	84.0	3.74	130	1,403
HB0036	3	1200	213T	89.5	78.0	4.02	220	2,019
HB0038	3	900	213/215T	85.5	66.0	4.98	192	2,503
HB0052	5	3600	182/184T	88.5	92.5	5.72	140	1,675
HB0054	5	1800	182/184T	89.5	85.5	6.12	150	1,568
HB0056	5	1200	213/215T	91.0	82.5	6.24	235	2,445
HB0058	5	900	254T	86.5	72.0	7.52	305	3,222
HB7/52	7.5	3600	213T	91.0	89.0	8.67	202	2,183
HB7/54	7.5	1800	213T	91.7	86.5	8.85	202	2,159
HB7/56	7.5	1200	254T	91.0	80.5	9.59	323	3,337
HB7/58	7.5	900	254/256T	86.5	71.5	11.5	365	3,728
HB0102	10	3600	213/215T	91.0	89.5	11.5	224	2,335
HB0104	10	1800	213/215T	91.7	88.0	11.6	224	2,369
HB0106	10	1200	254/256T	91.0	80.5	12.8	380	3,854
HB0108	10	900	284T	89.5	73.5	14.2	445	4,846
HB0152	15	3600	254T	92.4	91.5	16.6	323	3,275
HB0154	15	1800	254T	92.4	88.0	17.3	345	3,208
HB0156	15	1200	284T	92.4	83.5	18.2	540	4,726
HB0158	15	900	284/286T	89.5	78.0	20.1	510	5,964
HB0202	20	3600	254/256T	92.4	92.5	21.9	367	3,916
HB0204	20	1800	254/256T	93.0	87.5	23.0	425	3,781
HB0206	20	1200	284/286T	91.7	84.0	24.3	565	5,568
HB0208	20	900	324T	90.2	81.0	25.6	585	6,978
HB0252	25	3600	284TS	92.4	91.0	27.8	490	4,623
HB0254	25	1800	284T	93.6	86.0	29.1	555	4,469
HB0256	25	1200	324T	93.0	83.0	30.3	759	6,977
HB0258	25	900	324/326T	90.2	79.5	25.6	684	7,876
HB0302	30	3600	284/286TS	93.0	91.0	33.2	535	4,922
HB0304	30	1800	284/286T	93.6	87.5	34.3	656	4,801
HB0306	30	1200	324/326T	93.0	80.5	37.5	795	7,429
HB0308	30	900	364T	93.0	77.5	39.0	898	10,679
HB0402	40	3600	324TS	94.1	90.0	44.2	755	6,720
HB0404	40	1800	324T	94.1	86.0	46.3	740	6,584
HB0406	40	1200	364T	94.1	86.5	46.0	898	11,070
HB0408	40	900	364/365T	91.7	76.5	53.4	1,035	13,107
HB0502	50	3600	324/326TS	94.1	91.0	54.7	835	7,985
HB0504	50	1800	324/326T	94.5	87.0	56.9	835	7,377
HB0506	50	1200	364/365T	94.1	86.0	57.8	963	12,470
HB0508	50	900	404T	93.0	80.5	53.4	1,098	14,919

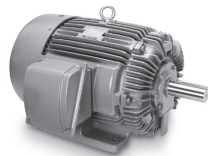

CATALOG NUMBER	HP	RPM	FRAME	FL EFF %	FL PF %	FL AMPS (460V)	APPROX. SHIPPING WT. (lbs.)	LIST PRICE (\$)
HB0602	60	3600	364TS	94.1	93.0	64.2	920	12,198
HB0604	60	1800	364T	95.0	86.5	68.4	930	11,592
HB0606	60	1200	404T	94.5	87.0	68.3	1,201	14,093
HB0608	60	900	404/405T	93.0	81.0	74.6	1,410	16,192
HB0752	75	3600	364/365TS	94.5	93.0	79.9	1,005	13,818
HB0754	75	1800	364/365T	95.4	86.5	85.1	1,040	12,897
HB0756	75	1200	404/405T	94.5	86.5	85.9	1,363	15,556
HB0758	75	900	444T	93.6	79.0	95.6	1,790	19,590
HB1002	100	3600	404/405TS	95.4	92.0	107	1,330	17,486
HB1004	100	1800	404/405T	95.4	87.5	112	1,385	15,882
HB1006	100	1200	444T	95.0	82.5	119	1,833	20,441
HB1008	100	900	444/445T	93.6	79.0	127	2,088	23,759
HB1252	125	3600	444TS	95.0	86.0	143	1,783	21,449
HB1254	125	1800	444T	95.4	84.0	146	1,833	20,383
HB1256	125	1200	444/445T	95.0	83.0	148	1,961	25,303
HB1258	125	900	445/447T	94.1	80.0	156	2,490	27,483
HB1502	150	3600	444/445TS	95.0	87.0	170	1,808	24,859
HB1504	150	1800	444/445T	95.8	84.0	175	2,037	22,597
HB1506	150	1200	445/447T	95.8	83.5	176	2,400	26,946
HB1508	150	900	447/449T	94.1	80.0	242	2,903	37,652
HB2002	200	3600	445/447TS	95.4	87.0	226	2,160	31,751
HB2004	200	1800	445/447T	96.2	84.5	230	2,426	27,127
HB2006	200	1200	447/449T	95.8	84.0	233	2,675	34,203
HB2008	200	900	447/449T	94.5	80.0	242	2,670	42,537
HB2502	250	3600	447/449TS	95.8	88.0	278	2,595	41,179
HB2504	250	1800	447/449T	96.2	85.5	285	2,801	36,996
HB2506	250	1200	447/449T	95.8	84.5	289	2,955	44,318
HB2508	250	900	5009B	95.0	81.0	304	4,200	69,130
HB3002	300	3600	447/449TS	95.8	88.0	326	2,928	51,009
HB3004	300	1800	449T	96.2	85.5	342	2,930	43,490
HB3006 ⁴	300	1200	447/449T	95.8	86.5	339	3,450	~
HB3008	300	900	5009B	95.0	81.0	365	4,410	72,523
HB3502 ³	350	3600	449TS	95.8	91.6	373	3,100	~
HB3504 ³	350	1800	449T	96.2	90.0	379	3,350	~
HB3506	350	1200	5010/11B	95.8	87.0	393	4,200	95,664
HB3508	350	900	5010/11B	95.0	81.0	426	5,040	100,445
HB4002	400	3600	5009A	95.8	91.6	427	3,450	94,691
HB4004	400	1800	5009B	96.2	90.0	433	3,700	88,121
HB4006	400	1200	5010/11B	95.8	87.0	449	4,900	105,363
HB4008	400	900	5808B	95.4	82.5	476	5,355	108,524
HB4502	450	3600	5010/11A	95.8	91.7	480	4,200	104,840
HB4504	450	1800	5010/11B	96.2	90.0	487	4,800	99,785
HB4506	450	1200	5808B	95.8	88.0	500	5,250	125,638
HB4508	450	900	5808B	95.4	82.5	535	5,723	130,664
HB5002	500	3600	5010/11A	95.8	91.7	533	4,600	115,344
HB5004	500	1800	5010/11B	96.2	90.0	541	5,000	106,147
HB5006	500	1200	5808B	95.8	88.0	555	5,600	128,895
HB5008	500	900	5810B	95.6	83.0	590	6,300	132,762

Notes:

- To check stock or order 575V motors, add "5" to the end of Catalog Number, for example: "HB00545" for 5 HP, 1800 RPM, 575V.
- Data subject to change without notice.
- Catalog# HB3502 & HB3504 are "Hybrid" ratings; Not CSA Certified (Self-Certify Only) for hazardous locations, and not dual drilled.
 - Self Certification available upon request at an additional fee
- Catalog# HB3006 also not CSA Certified for hazardous locations (Self-Certify Only).
 - Self Certification available upon request at an additional fee.

MAX-E2/841®



AEHH8BCF, NEMA PREMIUM, FOOTED C-FACE (1 HP - 100 HP) [HB_C]

Effective: 01-01-2022

AEUH8BDC, NEMA PREMIUM, ROUND BODY C-FACE (1 HP - 100 HP) [HBV_C]

Supersedes: 07-06-2021



HP	RPM	FRAME	FL EFF %	FL PF %	FL AMPS (460V)	APPROX. SHIPPING WT. (lbs.)	FOOTED C-FACE		ROUND BODY C-FACE	
							CATALOG NUMBER	LIST PRICE (\$)	CATALOG NUMBER	LIST PRICE (\$)
1	3600	143TC	82.5	85.0	1.34	58	HB0012C	1,386	HBV0012C	1,461
1	1800	143TC	85.5	73.0	1.50	58	HB0014C	1,379	HBV0014C	1,455
1	1200	143/145TC	82.5	65.5	1.73	97	HB0016C	1,480	HBV0016C	1,554
1.5	3600	143TC	84.0	83.5	2.00	65	HB1/52C	1,402	HBV1/52C	1,479
1.5	1800	143/145TC	86.5	78.0	2.08	65	HB1/54C	1,465	HBV1/54C	1,555
1.5	1200	182TC	87.5	63.5	2.53	137	HB1/56C	1,708	HBV1/56C	1,816
2	3600	143/145TC	86.5	86.0	2.52	78	HB0022C	1,444	HBV0022C	1,525
2	1800	143/145TC	86.5	78.0	2.78	97	HB0024C	1,486	HBV0024C	1,565
2	1200	182/184TC	88.5	70.5	3.00	150	HB0026C	1,928	HBV0026C	2,033
3	3600	182TC	88.5	90.0	3.53	100	HB0032C	1,708	HBV0032C	1,816
3	1800	182TC	89.5	84.0	3.74	130	HB0034C	1,708	HBV0034C	1,816
3	1200	213TC	89.5	78.0	4.02	220	HB0036C	2,696	HBV0036C	2,826
5	3600	182/184TC	88.5	92.5	5.72	140	HB0052C	1,979	HBV0052C	2,130
5	1800	182/184TC	89.5	85.5	6.12	150	HB0054C	1,921	HBV0054C	2,026
5	1200	213/215TC	91.0	82.5	6.24	235	HB0056C	2,896	HBV0056C	3,021
7.5	3600	213TC	91.0	89.0	8.67	202	HB7/52C	2,574	HBV7/52C	2,709
7.5	1800	213TC	91.7	86.5	8.85	202	HB7/54C	2,618	HBV7/54C	2,876
7.5	1200	254TC	91.0	80.5	9.59	323	HB7/56C	3,881	HBV7/56C	4,046
10	3600	213/215TC	91.0	89.5	11.5	224	HB0102C	2,760	HBV0102C	2,887
10	1800	213/215TC	91.7	88.0	11.6	224	HB0104C	2,811	HBV0104C	2,978
10	1200	254/256TC	91.0	80.5	12.8	380	HB0106C	4,490	HBV0106C	4,767
15	3600	254TC	92.4	91.5	16.6	323	HB0152C	3,812	HBV0152C	4,102
15	1800	254TC	92.4	88.0	17.3	345	HB0154C	3,798	HBV0154C	4,573
15	1200	284TC	92.4	83.5	18.2	540	HB0156C	5,499	HBV0156C	5,942
20	3600	254/256TC	92.4	92.5	21.9	367	HB0202C	4,552	HBV0202C	4,825
20	1800	254/256TC	93.0	87.5	23.0	425	HB0204C	4,490	HBV0204C	4,887
20	1200	284/286TC	91.7	84.0	24.3	565	HB0206C	6,634	HBV0206C	6,814
25	3600	284TSC	92.4	91.0	27.8	490	HB0252C	5,196	HBV0252C	5,395
25	1800	284TC	93.6	86.0	29.1	555	HB0254C	5,135	HBV0254C	6,089
25	1200	324TC	93.0	83.0	30.3	759	HB0256C	7,906	HBV0256C	8,149
30	3600	284/286TSC	93.0	91.0	33.2	535	HB0302C	5,536	HBV0302C	5,967
30	1800	284/286TC	93.6	87.5	34.3	656	HB0304C	5,536	HBV0304C	6,452
30	1200	324/326TC	93.0	80.5	37.5	795	HB0306C	8,462	HBV0306C	9,058
40	3600	324TSC	94.1	90.0	44.2	755	HB0402C	7,664	HBV0402C	8,396
40	1800	324TC	94.1	86.0	46.3	740	HB0404C	7,457	HBV0404C	7,709
40	1200	364TC	94.1	86.5	46.0	898	HB0406C	12,525	HBV0406C	12,814
50	3600	324/326TSC	94.1	91.0	54.7	782	HB0502C	8,823	HBV0502C	9,289
50	1800	324/326TC	94.5	87.0	56.9	845	HB0504C	8,629	HBV0504C	9,279
50	1200	364/365TC	94.1	86.0	57.8	1,110	HB0506C	14,547	HBV0506C	14,796
60	3600	364TSC	94.1	93.0	64.2	853	HB0602C	13,489	HBV0602C	13,758
60	1800	364TC	95.0	86.5	68.4	955	HB0604C	13,094	HBV0604C	13,370
60	1200	404TC	94.5	87.0	68.3	1,355	HB0606C	16,308	HBV0606C	16,652
75	3600	364/365TSC	94.5	93.0	79.9	1,015	HB0752C	15,283	HBV0752C	15,516
75	1800	364/365TC	95.4	86.5	85.1	1,040	HB0754C	14,613	HBV0754C	15,225
75	1200	404/405TC	94.5	86.5	85.9	1,363	HB0756C	17,753	HBV0756C	18,075
100	3600	404/405TSC	95.4	92.0	107	1,330	HB1002C	19,178	HBV1002C	19,471
100	1800	404/405TC	95.4	87.5	112	1,385	HB1004C	17,900	HBV1004C	18,215

Notes:

1. To check stock or order 575V motors, add "5" to the end of Catalog Number, for example: "HB00545" for 5 HP, 1800 RPM, 575V.
2. Data subject to change without notice.
3. Meets NEMA Design C Torque. All other motors are NEMA B Torque.
4. Footed C-Face Frame Size 140, BA dim = 2.25", Frame Size 180 BA dim = 2.75".
4. Various temp codes apply to round body ratings. Consult a stock product specialist for accurate code.

MAX-E2/841® VERTICAL ROUND BODY SOLID SHAFT HIGH THRUST with "P" BASE - LOW VOLTAGE



AEUH8BDP, NEMA PREMIUM, ROUND BODY (7/5 HP - 100 HP) [HBV_P]

Effective: 01-01-2022

Supersedes: 07-06-2021



APPLICATIONS:

- Centrifugal Pumps
- Petro-Chemical
- Water/ Wastewater
- Pulp and Paper

FEATURES:

- Output Range: 7.5 - 100 HP
- Speed: 3600, 1800 & 1200 RPM
- Enclosure: Totally Enclosed Fan Cooled (IP55)
- Voltage: 460V Only^{1,4}
- Three Phase, 60 Hz, 1.15 Service Factor (Continuous); 50 Hz, 1.0 Service Factor (Continuous)
- CSA Certified for Class I, Div. 2, Groups B, C, D - Temp Code T3 Minimum
- Meets or Exceeds IEEE 841 Standards
- Extended Warranty - 60 Months from Date of Manufacture
- Class F Insulation
- Class B Temperature Rise
- NEMA Design B Torques as a Minimum; Various Ratings also Meet Design C
- Cast Iron Frame, End Brackets, Fan Cover, Drip Cover and Main Conduit Box
- Grounding Terminal Inside Main Conduit Box with additional Foot Grounding Provision
- Oversized Main Conduit Box Rotatable in 90 Degree Increments - F1 Mounted
- Designed for 50°C Ambient Temperature²
- Designed for 3300 ft. Elevation³
- Bi-Directional Rotation
- 1045 Carbon Steel Shaft, LP Mounting
- Aluminum Die Cast Squirrel Cage Rotor Construction
- Paint System: 2 Part Epoxy
- Paint Color: Blue - Munsell 5PB 3/8
- Guide Bearings: Re-Greasable Single Shielded with Mobil Polyrex™ EM
- Thrust Bearings: Re-Greasable Double Stack Angular Contact with Mobil Polyrex™ EM
- Automatic Grease Discharge Fittings
- Cast Iron Inner and Outer Bearing Caps for all frames
- VBXX INPRO™ Seals Installed on Both Ends
- Stainless Steel Nameplate and Hardware
- Stainless Steel Automatic Breather Drain (Located at both End Brackets for Vertical Mounts)
- Dual Column Design Nameplate as Standard (60/50 Hz)
- Suitable for Inverter Use per NEMA MG-1.4.4.2, Part 31.^(5,6)
- Inverter Duty Speed Range: 20:1 Variable Torque, 10:1 Constant Torque
- Motors are U.L., CSA Approved
- 3 Leads Only
- Vibration Not to Exceed 0.08 Inches Per Second
- Noise Level Not to Exceed 85 dB(A) at 1 Meter Unloaded
- NEMA Type P Base With LP Shaft

EXTRAS/ OPTIONS:

Please refer to pages 147 - 152 for common modifications that can be performed.

Notes:

1. 575V motors available.
2. Consult a Stock Product Application Specialist for suitability in higher ambient environments.
3. Consult a Stock Product Application Specialist for suitability at higher elevations.
4. Motors 7.5 HP & up are suitable for wye/delta starting.
5. Motor service factor is 1.0 when operated on a VFD.
6. Precautions should be taken to eliminate or reduce shaft currents that may be imposed on the motor by the VFD as stated per NEMA MG-1, Part 31.

MAX-E2/841® VERTICAL ROUND BODY SOLID SHAFT HIGH THRUST with "P" BASE - LOW VOLTAGE



AEUH8BDP, NEMA PREMIUM, ROUND BODY [HBV_P]

Effective: 01-01-2022
Supersedes: 07-06-2021



CATALOG NUMBER	HP	RPM	FRAME	FL EFF %	FL PF %	FL AMPS (460V)	DOWN THRUST (lbs.)	AG DIM. (in.)	APPROX. SHIPPING WT. (lbs.)	LIST PRICE (\$)
HBV7/56P	7.5	1200	254LP	91.0	80.5	9.59	975	26.0	323	3,966
HBV0106P	10	1200	256LP	91.0	80.5	12.8	110	27.8	380	5,197
HBV0152P	15	3600	254LP	92.4	91.5	16.6	740	26.0	323	3,921
HBV0154P	15	1800	254LP	92.4	88.0	17.3	950	26.0	345	3,808
HBV0156P	15	1200	284LP	92.4	83.5	18.2	1200	29.1	540	6,534
HBV0202P	20	3600	256LP	92.4	92.5	21.9	840	27.8	367	5,113
HBV0204P	20	1800	256LP	93.0	87.5	23.0	1050	27.8	425	5,139
HBV0206P	20	1200	286LP	91.7	84.0	24.3	1570	30.4	565	7,759
HBV0252P	25	3600	284LP	92.4	91.0	27.8	900	27.8	490	5,915
HBV0254P	25	1800	284LP	93.6	86.0	29.1	1295	29.1	555	5,570
HBV0256P	25	1200	324LP	93.0	83.0	30.3	1750	32.6	759	9,353
HBV0302P	30	3600	286LP	93.0	91.0	33.2	960	29.3	535	6,818
HBV0304P	30	1800	286LP	93.6	87.5	34.3	1295	30.6	656	6,558
HBV0306P	30	1200	326LP	93.0	80.5	37.5	1750	34.0	795	10,320
HBV0404P	40	1800	324LP	94.1	86.0	46.3	1395	32.6	740	8,602
HBV0406P	40	1200	364LP	94.1	86.5	46.0	2200	31.1	898	13,654
HBV0504P	50	1800	326LP	94.5	87.0	56.9	1395	34.1	845	10,752
HBV0506P	50	1200	365LP	94.1	86.0	57.8	2200	36.5	1,110	16,557
HBV0604P	60	1800	364LP	95.0	86.5	68.4	1800	35.5	955	13,454
HBV0606P	60	1200	404LP	94.5	87.0	68.3	2825	39.6	1,355	19,398
HBV0754P	75	1800	365LP	95.4	86.5	85.1	1800	36.5	1,040	16,686
HBV0756P	75	1200	405LP	94.5	86.5	85.9	2825	37.8	1,363	22,634
HBV1004P	100	1800	405LP	95.4	87.5	112	2300	37.8	1,385	23,362

Notes:

1. Data subject to change without notice.

MAX-HT™ LOW VOLTAGE CRUSHER DUTY



AEHGD, NEMA PREMIUM, DESIGN C (20 HP - 500 HP) [CDP]
AEHGD, NEMA PREMIUM, DESIGN A (200 HP - 500 HP) [CDP]

Effective: 01-01-2022
Supersedes: 07-06-2021

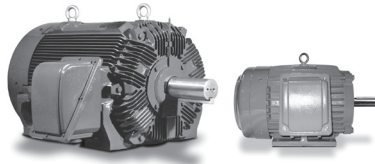

APPLICATIONS:

- Crushers
- Impactors
- Ball Mills/ Rolling Mills
- Any High Torque Application
- Chippers/ Shredders

FEATURES:

- Output Range: 20 - 500 HP
- Speed: 1800, 1200, 900 RPM
- Enclosure: Totally Enclosed Fan Cooled (IP55)
- Voltage: 230/460V (Usable on 208V); 150HP and Larger is 460V Only¹
- Three Phase, 60 Hz, 1.15 Service Factor (Continuous); 50 Hz, 1.0 Service Factor (Continuous)
- CSA Certified for Class I, Div. 2, Groups B, C, D - Temp Code T3 Minimum
- CSA Certified for Class II, Div. 2, Groups F & G - Temp Code T3 Minimum (Frame 444T and above)
- Class F Insulation
- Class B Temperature Rise
- NEMA Design C Torques; Equal or Greater Than 200% Starting Torque / 250% Breakdown Torque
- Cast Iron Frame, End Brackets, Main Conduit Box; Rolled Steel Fan Cover⁶
- Grounding Terminal Inside Main Conduit Box⁷
- Oversized Main Conduit Box Rotatable in 90 Degree Increments - F1 Mounted
- Designed for 40°C Ambient Temperature²
- Designed for 3300 ft. Elevation³
- Bi-Directional Rotation
- High Strength 4140 AISI Steel Shaft
- Aluminum Die Cast Squirrel Cage Rotor Construction
- Paint System: Phenolic Rust Proof Base Plus Polyurethane Top Coat
- Paint Color: Dark Gray - Munsell 7.5 BG 3.5/0.5
- High Quality Ball (or Roller) Bearings Regreasable with Mobil Polyrex™ EM
- Automatic Grease Discharge Fittings
- Gamma (Axial Face) Seal on Both Ends for F# 140T - 400T
- Labyrinth Type Metal Flinger on Both Ends for F# 440T and Larger
- Cast Iron Inner and Outer Bearing Caps for F# 320T and Larger
- Stainless Steel Nameplate
- New Dual Column Design Nameplate as Standard (60/50 Hz)
- Suitable for Inverter Use per NEMA MG-1 Part 31.4.4.2^(4,5)
- Inverter Duty Speed Range: 20:1 Variable Torque, 10:1 Constant Torque (350 HP and Larger are 3:1 Constant Torque)
- 12 Leads for 125 HP and Smaller
- 6 Leads for 150 HP and Larger
- Standard With Thermistors (PTC 140°C) 1 per Phase
- Locknut and Washer on NDE for Vertical Shaft Down Applications on F# 440 and Larger
- Drain Holes / Plugs on Both End Brackets for Vertical Applications
- Threaded One Way Breather Drains for Horizontal Mount Applications
- Spotface ¼ -28UNF Tap x 12mm Deep on Top of Both End Brackets with VB300 Vibration Sensor on 5000 Frames and Larger

EXTRAS/ OPTIONS:

Please refer to pages 147 - 152 for common modifications that can be performed.

Notes:

1. 575V motors available on a made-to order basis. Consult a Stock Product Application Specialist for details.
2. Consult a Stock Product Application Specialist for suitability in higher ambient environments.
3. Consult a Stock Product Application Specialist for suitability at higher elevations.
4. Motor service factor is 1.0 when operated on a VFD.
5. Precautions should be taken to eliminate or reduce shaft currents that may be imposed on the motor by the VFD as stated per NEMA MG-1, Part 31.
6. F# 5000 and with Larger with Pressed Steel Plate Main Conduit Box; CDPxxxRZs have a cast iron box with Grade 8 bolts.
7. Additional Foot Grounding Provision for F# 440 and Larger.

MAX-HT™ LOW VOLTAGE CRUSHER DUTY



AEHHGD, NEMA PREMIUM, DESIGN C [CDP]

Effective: 01-01-2022
Supersedes: 07-06-2021

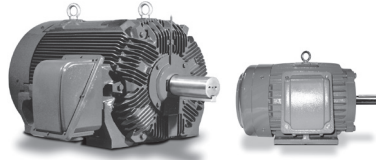

CATALOG NUMBER	HP	RPM	FRAME	FL EFF %	FL PF %	FL AMPS (460V)	APPROX. SHIPPING WT. (lbs.)	LIST PRICE (\$)
CDP0204	20	1800	256T	93.0	86.0	23.4	395	3,289
CDP0206	20	1200	286T	91.7	84.0	24.3	520	3,985
CDP0208	20	900	324T	91.0	81.0	25.4	557	6,433
CDP0254	25	1800	284T	93.6	86.0	29.1	510	3,668
CDP0256	25	1200	324T	93.0	83.0	30.3	745	6,166
CDP0258	25	900	326T	91.0	80.0	32.2	665	7,181
CDP0304	30	1800	286T	93.6	87.5	34.3	545	4,174
CDP0306	30	1200	326T	93.0	80.5	37.5	775	6,226
CDP0308	30	900	364T	93.0	78.0	38.7	718	7,635
CDP0308R	30	900	364T	93.0	78.0	38.7	718	7,635
CDP0404	40	1800	324T	91.4	86.0	46.3	710	5,494
CDP0406	40	1200	364T	91.4	86.5	46.0	945	8,476
CDP0406R	40	1200	364T	91.4	86.5	46.0	945	8,476
CDP0408	40	900	365T	93.0	78.0	52.0	807	11,689
CDP0408R	40	900	365T	93.0	78.0	52.0	807	11,689
CDP0504	50	1800	326T	94.5	87.0	57.0	795	6,404
CDP0506	50	1200	365T	94.1	86.0	58.0	1,040	10,009
CDP0506R	50	1200	365T	94.1	86.0	58.0	1,040	10,009
CDP0508	50	900	404T	93.0	81.0	62.0	868	13,433
CDP0508R	50	900	404T	93.0	81.0	62.0	868	13,433
CDP0604	60	1800	364T	95.0	86.5	68.0	870	9,013
CDP0604R	60	1800	364T	95.0	86.5	68.0	870	9,013
CDP0606	60	1200	404T	94.5	87.0	68.0	1,295	13,267
CDP0606R	60	1200	404T	94.5	87.0	68.0	1,295	13,267
CDP0608	60	900	405T	93.0	81.0	75.0	1,243	15,025
CDP0608R	60	900	405T	93.0	81.0	75.0	1,243	15,025
CDP0754	75	1800	365T	95.4	86.5	85.0	1,075	11,526
CDP0754R	75	1800	365T	95.4	86.5	85.0	1,075	11,526
CDP0756	75	1200	405T	94.5	86.5	86.0	1,317	13,962
CDP0756R	75	1200	405T	94.5	86.5	86.0	1,317	13,962
CDP0758	75	900	444T	93.6	73.0	103	1,600	29,964
CDP0758R	75	900	444T	93.6	73.0	103	1,600	29,964
CDP1004	100	1800	405T	95.4	87.5	112	1,360	14,381
CDP1004R	100	1800	405T	95.4	87.5	112	1,360	14,381
CDP1006	100	1200	444T	95.0	82.5	119	1,665	24,546
CDP1006R	100	1200	444T	95.0	82.5	119	1,665	24,546
CDP1008	100	900	445T	93.6	78.0	128	1,800	30,925
CDP1008R	100	900	445T	93.6	78.0	128	1,800	30,925
CDP1254	125	1800	444T	95.4	85.0	144	1,705	24,809
CDP1254R	125	1800	444T	95.4	85.0	144	1,705	24,809
CDP1256	125	1200	445T	95.0	83.0	148	1,995	30,298
CDP1256R	125	1200	445T	95.0	83.0	148	1,995	30,298
CDP1258	125	900	447T	94.1	80.0	155	2,450	34,970
CDP1258R	125	900	447TZ	94.1	80.0	155	2,450	34,970

Notes:

1. AEHHGD "CDP" motors replace AEEAGD "CD" motor line in compliance to new DOE standards.
2. Data subject to change without notice.

MAX-HT™ LOW VOLTAGE CRUSHER DUTY



AEHGD, NEMA PREMIUM, DESIGN A DESIGN C [CDP]

Effective: 01-01-2022
Supersedes: 07-06-2021

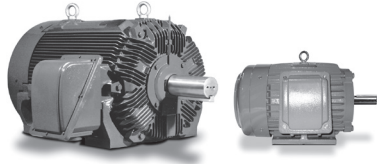

CATALOG NUMBER	HP	RPM	FRAME	FL EFF %	FL PF %	FL AMPS (460V)	APPROX. SHIPPING WT. (lbs.)	LIST PRICE (\$)
CDP1504	150	1800	445T	95.8	85.0	172	1,865	25,991
CDP1504R	150	1800	445T	95.8	85.0	172	1,865	25,991
CDP1506	150	1200	447T	95.8	83.5	176	2,363	32,722
CDP1506R	150	1200	447TZ	95.8	83.5	176	2,363	32,722
CDP1508	150	900	449T	94.1	80.0	187	2,800	40,643
CDP1508R	150	900	449TZ	94.1	80.0	187	2,800	40,643
CDP2004	200	1800	447T	95.4	87.0	226	2,465	28,816
CDP2004R	200	1800	447TZ	95.4	87.0	226	2,465	28,816
CDP2006T	200	1200	449T	95.8	84.0	233	2,783	32,447
CDP2006R	200	1200	449TZ	95.8	84.0	233	2,783	35,322
CDP2006RZ	200	1200	505UZ	95.8	79.9	245	3,200	38,265
CDP2008T	200	900	449T	94.5	82.5	240	2,875	35,927
CDP2008TR	200	900	447/9TZ	94.5	82.5	240	2,875	33,993
CDP2008R	200	900	5007C	94.5	80.2	247	2,000	48,537
CDP2008RZ	200	900	586/7UZ	94.5	77.2	257	2,370	71,428
CDP2504TB	250	1800	449T	96.2	85.0	286	2,750	32,703
CDP2504TR	250	1800	447/9TZ	96.2	85.0	286	2,760	32,703
CDP2504R	250	1800	5007C	96.2	82.4	295	3,620	36,850
CDP2504RZ	250	1800	505UZ	96.2	82.4	295	3,250	38,932
CDP2506TR	250	1200	447/9TZ	95.8	78.5	311	2,925	33,401
CDP2506R	250	1200	5007C	95.8	80.4	304	3,760	43,345
CDP2506RZ	250	1200	586/7UZ	95.8	80.2	305	4,850	58,294
CDP2508R	250	900	5009C	95.0	81.9	301	2,250	58,481
CDP2508RZ	250	900	586/7UZ	95.0	78.1	316	2,450	77,593
CDP3004TR	300	1800	447/9TZ	96.2	84.0	348	2,865	38,116
CDP3004R	300	1800	5007C	96.2	83.5	350	3,750	43,901
CDP3004RZ	300	1800	586/7UZ	96.2	82.7	353	4,900	60,991
CDP3006TR(2)	300	1200	447/9TZ	95.8	82.5	355	3,450	47,129
CDP3006R	300	1200	5009C	95.8	83.0	353	4,350	49,771
CDP3006RZ	300	1200	586/7UZ	95.8	81.7	359	4,950	63,991
CDP3504TR	350	1800	447/9TZ	96.2	88.5	385	3,300	40,284
CDP3504R	350	1800	5009C	96.2	86.2	395	4,140	45,070
CDP3504RZ	350	1800	586/7UZ	96.2	82.7	412	5,050	63,263
CDP3506R	350	1200	5806C	95.8	79.5	430	5,680	65,994
CDP3506RZ	350	1200	586/7UZ	95.8	80.6	424	5,100	66,237
CDP4004R	400	1800	5806C	96.2	83.3	467	5,650	66,670
CDP4004RZ	400	1800	586/7UZ	96.2	83.2	468	5,200	67,384
CDP4504R	450	1800	5808C	96.2	82.5	531	5,650	68,031
CDP4504RZ	450	1800	586/7UZ	96.2	82.8	529	5,300	69,137
CDP5004R	500	1800	5808C	96.2	85.6	569	5,860	72,959
CDP5004RZ	500	1800	586/7UZ	96.2	84.4	577	5,450	73,975

Notes:

1. Data subject to change without notice.
2. CDP3006TR is not suitable for 50HZ operation and the nameplate data will not include 50HZ data.

MAX-HT™ LOW VOLTAGE CRUSHER DUTY

EPACT 

AAEAGD, EPACT DESIGN C (300 HP - 600 HP) [CD]

Effective: 01-01-2022
Supersedes: 07-06-2021

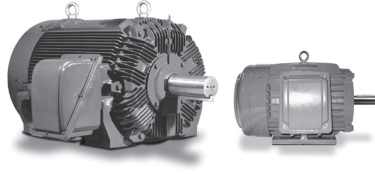

APPLICATIONS:

- Crushers
- Impactors
- Chippers/ Shredders
- Ball Mills/ Rolling Mills
- Any High Torque Application

FEATURES:

- Output Range: 300 - 600 HP
- Speed: 1200, 900 RPM
- Enclosure: Totally Enclosed Fan Cooled (IP55)
- Voltage: 460V¹
- Three Phase, 60 Hz, 1.15 Service Factor (Continuous); 50 Hz, 1.0 Service Factor (Continuous)
- Class F Insulation
- Class B Temperature Rise
- NEMA Design C Torques; Equal or Greater Than 200% Starting Torque / 250% Breakdown Torque
- Cast Iron Frame, End Brackets; Pressed Steel Plate Main Conduit Box and Fan Cover
- Cast Iron Main Conduit Box of 505UZ Frame
- Grounding Terminal Inside Main Conduit Box with additional Foot Grounding Provision
- Oversized Main Conduit Box Rotatable in 90 Degree Increments - F1 Mounted
- Designed for 40°C Ambient Temperature²
- Designed for 3300 ft. Elevation³
- Bi-Directional Rotation
- High Strength 4140 AISI Steel Shaft
- Aluminum Die Cast Squirrel Cage Rotor Construction
- Paint System: Phenolic Rust Proof Base Plus Polyurethane Top Coat
- Paint Color: Dark Gray - Munsell 7.5 BG 3.5/0.5
- High Quality Ball (or Roller) Bearings Regreasable with Mobil Polyrex™ EM
- Automatic Grease Discharge Fittings
- Metal Flinger on Both Ends
- Cast Iron Inner and Outer Bearing Caps
- Stainless Steel Nameplate
- Dual Column Design Nameplate as Standard (60/50 Hz)
- Suitable for Inverter Use per NEMA MG-1 Part 31.4.4.2^(4,5)
- Inverter Duty Speed Range: 3:1 Constant Torque
- 6 Leads
- Standard With Thermistors (PTC 140°C) 1 per Phase
- Locknut and Washer on NDE for Vertical Shaft Down Applications
- Drain Holes / Plugs on Both End Brackets for Vertical Applications
- Threaded One Way Breather Drains for Horizontal Mount Applications
- Motors are CSA Approved
- Spotface ¼ -28UNF Tap x 12mm Deep on Top of Both End Brackets with VB300 Vibration Sensor on 5000 Frames and Larger

EXTRAS/ OPTIONS:

Please refer to pages 147 - 152 for common modifications that can be performed.

Notes:

1. 575V motors available on a made-to order basis. Consult a Stock Product Application Specialist for details.
2. Consult a Stock Product Application Specialist for suitability in higher ambient environments.
3. Consult a Stock Product Application Specialist for suitability at higher elevations.
4. Motor service factor is 1.0 when operated on a VFD.
5. Precautions should be taken to eliminate or reduce shaft currents that may be imposed on the motor by the VFD as stated per NEMA MG-1, Part 31.

MAX-HT™ LOW VOLTAGE CRUSHER DUTY



AEEAGD, EPACT DESIGN C [CD]

Effective: 01-01-2022

Supersedes: 07-06-2021

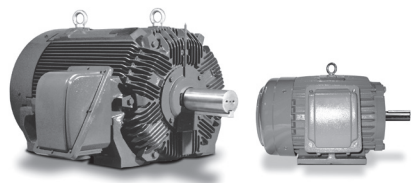

CATALOG NUMBER	HP	RPM	FRAME	FL EFF %	FL PF %	FL AMPS (460V)	APPROX. SHIPPING WT. (lbs.)	LIST PRICE (\$)
CD3008R ¹	300	900	5806C	94.5	81.0	367	5,093	65,480
CD4006R ¹	400	1200	5808C	95.0	85.5	461	5,100	59,466
CD4006RZ ¹	400	1200	586/7UZ	95.0	85.5	461	6,020	59,466
CD4008R ¹	400	900	5808C	95.0	81.0	487	5,828	83,152
CD4506R ¹	450	1200	5808C	95.4	85.5	517	5,565	64,290
CD5006R ¹	500	1200	5808C	95.4	85.5	574	6,020	68,373
CD6006R ¹	600	1200	5810C	95.4	85.5	689	6,898	98,068

Notes:

1. Per DOE regulations, the smaller frame non-exempt High Efficiency inventory was obsoleted in June 2018, and only has minimal inventory. Please see our new line of Design A Premium Efficient Crusher Duty (AEHHGD) motors on page 90.
2. Data subject to change without notice.

MAX-HT™ MEDIUM VOLTAGE CRUSHER DUTY



AEHAGD, ENERGY EFFICIENT, HIGH TORQUE (100 HP - 900 HP) [KD]

Effective: 01-01-2022
Supersedes: 07-06-2021

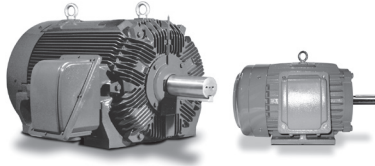

APPLICATIONS:

- Mills
- Grinders
- Compressors
- Crushers
- Impacters
- Ball Mills
- Shredders
- High Torque Applications

FEATURES:

- Output Range: 100 - 900 HP
- Speed: 1800, 1200, 900 RPM
- Enclosure: Totally Enclosed Fan Cooled (IP55)
- Voltage: 2300/4000V¹
- Three Phase, 60 Hz, 1.15 Service Factor (Continuous)
- CSA Certified for Class I, Div. 2, Groups B, C, D - Temp Code T3 Minimum
- CSA Certified for Class II, Div. 2, Groups F & G - Temp Code T3 Minimum
- Class F Insulation
- Class B Temperature Rise
- NEMA Design C Torques; Equal or Greater Than 200% Starting Torque / 250% Breakdown Torque
- Cast Iron Frame, End Brackets; Pressed Steel Plate Main Conduit Box and Fan Cover⁵
- Grounding Terminal Inside Main Conduit Box with additional Foot Grounding Provision
- Oversized Main Conduit Box Rotatable in 90 Degree Increments - F1 Mounted
- Designed for 40°C Ambient Temperature²
- Designed for 3300 ft. Elevation³
- Bi-Directional Rotation
- High Strength 4140 AISI Steel Shaft
- Aluminum Die Cast Squirrel Cage Rotor Construction
- Paint System: Phenolic Rust Proof Base Plus Polyurethane Top Coat
- Paint Color: Dark Gray - Munsell 7.5 BG 3.5/0.5
- High Quality Ball (or Roller) Bearings Regreasable with Mobil Polyrex™ EM
- Automatic Grease Discharge Fittings
- Metal Flinger on Both Ends
- Cast Iron Inner and Outer Bearing Caps
- Stainless Steel Nameplate
- Suitable for Inverter Duty (PWM - Pulse Width Modulation) per NEMA MG-1⁶
- Inverter Duty Speed Range: 10:1 Variable Torque, 3:1 Constant Torque
- 6 Leads
- CSA Approved
- Locknut and Washer on NDE for Vertical Shaft Down Applications
- Drain Holes / Plugs on Both End Brackets for Vertical Applications
- Threaded One Way Breather Drains for Horizontal Mount Applications
- 100 Ohm Platinum Stator RTD's (2/Phase); in separate Auxiliary Box
- Space Heaters (120V); in separate Auxiliary Box⁴
- Mounting Provisions for Bearing RTD's and Vibration Detectors on F# 5007 and Larger
- Spotface ¼ -28UNF Tap x 12mm Deep on Top of Both End Brackets with VB300 Vibration Sensor on 5000 Frames and Larger

EXTRAS/ OPTIONS:

Please refer to pages 147 - 152 for common modifications that can be performed.

Notes:

1. Suitable for Full Voltage Direct On-Line Connection, Wye-Delta Start, Reduced Voltage Start or VFD.
2. Consult a Stock Product Application Specialist for suitability in higher ambient environments.
3. Consult a Stock Product Application Specialist for suitability at higher elevations.
4. Space Heaters are Low Temperature Type; Suitable for Hazardous Location Division 2 Environments
5. F# 447T(Z) - 449T(Z) with Cast Iron Main Conduit Box and Cast Iron Fan Cover.
6. Motor service factor is 1.0 when operated on a VFD.

MAX-HT™ MEDIUM VOLTAGE CRUSHER DUTY



AEHAGD, ENERGY EFFICIENT, HIGH TORQUE [KD]

Effective: 01-01-2022
Supersedes: 07-06-2021

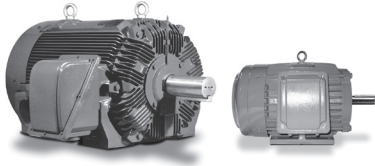

CATALOG NUMBER	HP	RPM	FRAME	FL EFF %	FL PF %	FL AMPS (460V)	APPROX. SHIPPING WT. (lbs.)	LIST PRICE (\$)
KD1004	100	1800	445/447T	94.5	82.2	24.0	2,220	44,180
KD1006R	100	1200	445/447TZ	94.1	77.8	26.0	2,175	45,443
KD1008R	100	900	445/447TZ	93.0	72.2	28.0	2,400	46,392
KD1254	125	1800	445/447T	94.5	82.6	30.0	2,350	49,025
KD1256R	125	1200	447/449TZ	94.1	79.2	32.0	2,625	49,665
KD1258R	125	900	447/449TZ	93.6	72.5	35.0	2,575	58,048
KD1504	150	1800	447/449T	95.0	83.0	36.0	2,550	57,053
KD1506R	150	1200	5007C	95.0	74.9	40.0	3,830	66,618
KD1508R	150	900	5007C	93.6	76.7	40.0	3,650	71,143
KD2004	200	1800	5007B	95.0	82.6	48.0	3,970	68,154
KD2006R	200	1200	5007C	95.0	75.0	55.0	3,950	82,127
KD2008R	200	900	5009C	94.1	76.3	53.0	3,875	89,760
KD2504	250	1800	5007B	95.0	82.7	60.0	4,050	82,788
KD2506R	250	1200	5009C	95.0	75.8	66.0	4,080	90,508
KD2508R	250	900	5009C	94.5	76.5	65.0	4,210	102,746
KD3004	300	1800	5009B	95.4	83.0	72.0	4,155	86,455
KD3006R	300	1200	5009C	95.0	76.0	79.0	4,235	97,786
KD3008R	300	900	5010/5011C	94.5	77.1	78.0	4,660	109,558
KD3504	350	1800	5009B	95.4	82.8	84.0	4,305	97,866
KD3506R	350	1200	5010/5011C	95.0	76.8	91.0	4,460	105,882
KD3508R	350	900	5808C	94.5	76.0	92.0	5,825	132,251
KD4004	400	1800	5010/5011B	95.4	83.7	95.0	4,490	103,295
KD4006R	400	1200	5808C	95.0	75.3	106	4,725	114,025
KD4008R	400	900	5808C	94.5	75.8	106	6,280	142,076
KD4504	450	1800	5010/5011B	95.4	83.7	107	4,620	109,012
KD4506R	450	1200	5808C	95.0	75.8	118	5,400	127,375
KD4508R	450	900	5810C	94.5	75.9	119	6,585	142,900
KD5004	500	1800	5010/5011B	95.8	82.9	119	4,845	115,994
KD5006R	500	1200	5810C	95.0	76.5	130	5,710	140,046
KD5008R	500	900	5810C	94.5	76.1	131	7,040	150,209
KD6004	600	1800	5810B	95.8	81.9	144	6,115	135,293
KD6006R	600	1200	5810C	95.0	78.1	153	6,160	158,623
KD6008R	600	900	6808C	94.5	76.8	156	7,830	200,359
KD7004	700	1800	5810B	95.8	82.6	167	6,610	155,128
KD7006R	700	1200	6808C	95.0	81.8	170	8,260	183,770
KD7008R	700	900	6808C	94.5	77.1	182	8,755	201,683
KD8004	800	1800	6808B	95.8	80.3	196	7,900	175,534
KD8006R	800	1200	6808C	95.0	82.3	193	8,955	201,294
KD9004	900	1800	6808B	95.8	80.9	219	8,360	188,069

Notes:

1. Data subject to change without notice.

STAINLESS STEEL WASHDOWN



AEGP, NEMA PREMIUM, TEFC, FOOTED C-FACE, F3 [WFP/WP]
AEGPCW, NEMA PREMIUM, TEFC, ROUND BODY C-FACE [WFPV/WPV]
AEGPQL, NEMA PREMIUM, TEFC, FOOTED C-FACE, F1 [WFR/WR]
AEGNQL, NEMA PREMIUM, TENV, FOOTED C-FACE, F1 [WFN/WN]
AETNQL, NEMA PREMIUM, TENV, ROUND BODY C-FACE [WFNV/WNV]

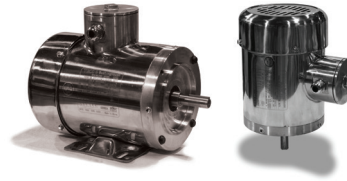

Effective: 01-01-2022
Supersedes: 07-06-2021



APPLICATIONS:

- Any Application Where the Motor Will be Subjected to High Pressure Spray Down
- Marine Duty
- Food Processing and Packaging

FEATURES:

- Output: 1/2 - 10 HP TEFC; 1/2 - 3HP TENV
- Speed: 3600 & 1800 RPM
- Enclosure: Totally Enclosed Fan Cooled (IP66) (IEEE 45); and Total Enclosed Non-Ventilated (IP66) (IEEE45),
- TENV Motor Also Available With Encapsulated Windings (IP66).
- Voltage: 230/460V (Usable on 208V)
- Three Phase, 60 Hz, 1.15 Service Factor (Continuous); 50 Hz, 1.0 Service Factor (Continuous)
- Class F Insulation
- Class B Temperature Rise
- NEMA Design B Torques
- Stainless Steel Frame, End Brackets and Hardware
- Grounding Terminal Inside Main Conduit Box
- Stainless Steel Oversized Main Conduit Box - F3 Mounted for TEFC Footed, F1 Mounted for TEFC, and F1 Mounted for TENV Footed
- Designed for 40°C Ambient Temperature¹
- Designed for 3300 ft. Elevation²
- Bi-Directional Rotation
- SUS304 Stainless Steel Shaft
- Aluminum Die Cast Squirrel Cage Rotor Construction
- Sealed Bearings Pre-Packed with POLYREX™ EM
- Contact Lip Type Seal on Both Ends
- Etched Nameplate on the Stainless Steel Frame
- Dual Column Design Nameplate as Standard (60/50 Hz)
- Suitable for Inverter Use per NEMA MG-1 Part 31.4.4.2^(3,4)
- Inverter Duty Speed Range: 10:1 Variable Torque, 4:1 Constant Torque
- 9 Leads
- Four Drain Holes on DE/NDE brackets
- Motors are U.L. Recognized, CSA Approved and CE Marked
- Department of Energy Efficiency Certificate # CC082A
- Encapsulated windings available for all Washdown motors⁽⁶⁾
- IP69K available for all Washdown motors
- BISSC third party varified

EXTRAS/ OPTIONS:

- Please refer to pages 147 - 152 for common modifications that can be performed.

Notes:

1. Consult a Stock Product Application Specialist for suitability in higher ambient environments.
2. Consult a Stock Product Application Specialist for suitability at higher elevations.
3. Motor service factor is 1.0 when operated on a VFD.
4. Precautions should be taken to eliminate or reduce shaft currents that may be imposed on the motor by the VFD as stated per NEMA MG-1. Part 31.
5. Turn down the same as TEFC 60 min. duty intermittent.
6. Food grade grease is available with M16 Mod.

STAINLESS STEEL WASHDOWN



Effective: 01-01-2022
Supersedes: 07-06-2021

- AEGP, NEMA PREMIUM, TEFC, FOOTED C-FACE, F3 [WFP/WP]**
- AEGPQL, NEMA PREMIUM, TEFC, FOOTED C-FACE, F1 [WFR/WR]**
- AEGPCW, NEMA PREMIUM, TEFC, ROUND BODY C-FACE [WFPV/WPV]**
- AEGNQL, NEMA PREMIUM, TENV, FOOTED C-FACE, F1 [WFN/WN]**
- AETNQL, NEMA PREMIUM, TENV, ROUND BODY C-FACE [WFNV/WNV]**

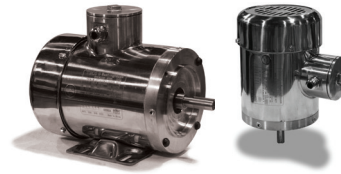

HP	RPM	FRAME	FL EFF %	FL PF %	FL AMPS (460V)	APPROX. SHIPPING WT. (lbs.)	FOOTED C-FACE		ROUND BODY C-FACE	
							CATALOG NUMBER	LIST PRICE (\$)	CATALOG NUMBER	LIST PRICE (\$)
1/2	3600	56C	75.0	79.0	0.80	37	WFP0/52C	928	WFPV0/52C	928
1/2	1800	56C	80.0	65.0	0.90	37	WFP0/54C	948	WFPV0/54C	948
3/4	3600	56C	77.0	84.0	1.10	39	WFP0/72C	1,074	WFPV0/72C	1,074
3/4	1800	56C	80.0	68.0	1.30	39	WFP0/74C	1,084	WFPV0/74C	1,084
1	3600	56C	77.0	90.0	1.40	37	WFP0012C	1,250	WFPV0012C	1,250
1	3600	143/145TC	77.0	90.0	1.40	46	WP0012C	1,439	WPV0012C	1,439
1	1800	56C/56HC	85.5	70.0	1.60	44	WFP0014C	1,275	WFPV0014C	1,275
1	1800	143/145TC	85.5	70.0	1.60	46	WP0014C	1,339	WPV0014C	1,339
1.5	3600	56C/56HC	84.0	90.0	2.00	45	WFP1/52C	1,380	WFPV1/52C	1,380
1.5	3600	143/145TC	84.0	90.0	2.00	50	WP1/52C	1,570	WPV1/52C	1,570
1.5	1800	56C/56HC	86.5	73.0	2.20	55	WFP1/54C	1,430	WFPV1/54C	1,430
1.5	1800	143/145TC	86.5	73.0	2.20	58	WP1/54C	1,495	WPV1/54C	1,495
2	3600	56C/56HC	85.5	91.0	2.40	52	WFP0022C	1,567	WFPV0022C	1,567
2	3600	143/145TC	85.5	91.0	2.40	58	WP0022C	1,737	WPV0022C	1,737
2	1800	56C/56HC	86.5	75.0	3.00	62	WFP0024C	1,587	WFPV0024C	1,587
2	1800	143/145TC	86.5	75.0	3.00	65	WP0024C	1,608	WPV0024C	1,608
3	3600	182/184TC	86.5	88.0	4.10	80	WP0032C	3,066	WPV0032C	3,066
3	1800	182/184TC	86.5	78.0	4.00	115	WP0034C	3,061	WPV0034C	3,061
5	3600	182/184TC	88.5	91.0	6.10	128	WP0052C	3,654	WPV0052C	3,654
5	1800	182/184TC	89.5	85.0	6.30	128	WP0054C	3,723	WPV0054C	3,723
7.5	3600	213/215TC	89.5	85.0	9.50	175	WP7/52C	4,981	WPV7/52C	4,981
7.5	1800	213/215TC	91.7	82.0	9.30	190	WP7/54C	4,903	WPV7/54C	4,903
10	3600	213/215TC	90.2	87.0	12.2	210	WP0102C	5,430	WPV0102C	5,430
10	1800	213/215TC	91.7	84.0	12.2	225	WP0104C	5,630	WPV0104C	5,630

Notes:

1. Select catalog numbers have changed in order to follow the following format:
 "WFPV" = TEFC 56 Frame Round Body C-Face
 "WFP" = TEFC F3 56 Frame Footed C-Face
 "WPV" = TEFC F#140TC - F#210TC Round Body C-Face
 "WP" = TEFC F3 F#140TC - F#210TC Footed C-Face
 "WFRV" = TEFC 56 Frame Round Body C-Face
 "WFR" = TEFC F1 56 Frame Footed C-Face
 "WRV" = TEFC F#140TC - F#210TC Round Body C-Face
 "WR" = TEFC F1 F#140TC - F#210TC Footed C-Face
 "WFNV" = TENV 56 Frame Round Body C-Face
 "WFN" = TENV F1 56 Frame Footed C-Face
 "WNV" = TENV F#140TC - F#180TC Round Body C-Face
 "WN" = TENV F1 F#140TC - F#180TC Footed C-Face
 "-E" At the end of Catalog Numbers adds Encapsulation to the motor.
2. Data subject to change without notice.

STAINLESS STEEL WASHDOWN



Effective: 01-01-2022
Supersedes: 07-06-2021

- AEGP, NEMA PREMIUM, TEFC, FOOTED C-FACE, F3 [WFP/WP]
- AEGPCW, NEMA PREMIUM, TEFC, ROUND BODY C-FACE [WFPV/WPV]
- AEGPQL, NEMA PREMIUM, TEFC, FOOTED C-FACE, F1 [WFR/WR]
- AEGNQL, NEMA PREMIUM, TENV, FOOTED C-FACE, F1 [WFN/WN]
- AETNQL, NEMA PREMIUM, TENV, ROUND BODY C-FACE [WFNV/WNV]

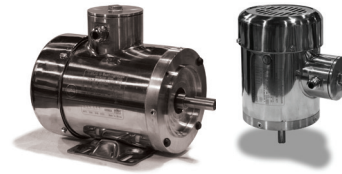

HP	RPM	FRAME	FL EFF %	FL PF %	FL AMPS (460V)	APPROX. SHIPPING WT. (lbs.)	FOOTED C-FACE	
							CATALOG NUMBER	LIST PRICE (\$)
1/2	3600	56C	75.0	79.0	0.80	37	WFR0/52C	928
1/2	1800	56C	80.0	65.0	0.90	37	WFR0/54C	948
3/4	3600	56C	77.0	84.0	1.10	39	WFR0/72C	1,074
3/4	1800	56C	80.0	68.0	1.30	39	WFR0/74C	1,084
1	3600	56C	77.0	90.0	1.40	37	WFR0012C	1,250
1	3600	143/145TC	77.0	90.0	1.40	46	WR0012C	1,430
1	1800	56C/56HC	85.5	70.0	1.60	44	WFR0014C	1,439
1	1800	143/145TC	85.5	70.0	1.60	46	WR0014C	1,495
1.5	3600	56C/56HC	84.0	90.0	2.00	45	WFR1/52C	1,275
1.5	3600	143/145TC	84.0	90.0	2.00	50	WR1/52C	1,567
1.5	1800	56C/56HC	86.5	73.0	2.20	55	WFR1/54C	1,339
1.5	1800	143/145TC	86.5	73.0	2.20	58	WR1/54C	1,737
2	3600	56C/56HC	85.5	91.0	2.40	52	WFR0022C	1,380
2	3600	143/145TC	85.5	91.0	2.40	58	WR0022C	1,587
2	1800	56C/56HC	86.5	75.0	3.00	62	WFR0024C	1,570
2	1800	143/145TC	86.5	75.0	3.00	65	WR0024C	1,608
3	3600	182/184TC	86.5	88.0	4.10	80	WR0032C	3,066
3	1800	182/184TC	86.5	78.0	4.00	115	WR0034C	3,061
5	3600	182/184TC	88.5	91.0	6.10	128	WR0052C	3,654
5	1800	182/184TC	89.5	85.0	6.30	128	WR0054C	3,723
7.5	3600	213/215TC	89.5	85.0	9.50	175	WR7/52C	4,981
7.5	1800	213/215TC	91.7	82.0	9.30	190	WR7/54C	4,903
10	3600	213/215TC	90.2	87.0	12.2	210	WR0102C	5,430
10	1800	213/215TC	91.7	84.0	12.2	225	WR0104C	5,630

Notes:

- Select catalog numbers have changed in order to follow the following format:
 "WFPV" = TEFC 56 Frame Round Body C-Face
 "WFP" = TEFC F3 56 Frame Footed C-Face
 "WPV" = TEFC F#140TC - F#210TC Round Body C-Face
 "WP" = TEFC F3 F#140TC - F#210TC Footed C-Face
 "WFRV" = TEFC 56 Frame Round Body C-Face
 "WFR" = TEFC F1 56 Frame Footed C-Face
 "WRV" = TEFC F#140TC - F#210TC Round Body C-Face
 "WR" = TEFC F1 F#140TC - F#210TC Footed C-Face
 "WFNV" = TENV 56 Frame Round Body C-Face
 "WFN" = TENV F1 56 Frame Footed C-Face
 "WNV" = TENV F#140TC - F#180TC Round Body C-Face
 "WN" = TENV F1 F#140TC - F#180TC Footed C-Face
 "-E" At the end of Catalog Numbers adds Encapsulation to the motor.
- Data subject to change without notice.

STAINLESS STEEL WASHDOWN



Effective: 01-01-2022
Supersedes: 07-06-2021

- AEGP, NEMA PREMIUM, TEFC, FOOTED C-FACE, F3 [WFP/WP]**
- AEGPCW, NEMA PREMIUM, TEFC, ROUND BODY C-FACE [WFPV/WPV]**
- AEGPQL, NEMA PREMIUM, TEFC, FOOTED C-FACE, F1 [WFR/WR]**
- AEGNQL, NEMA PREMIUM, TENV, FOOTED C-FACE, F1 [WFN/WN]**
- AETNQL, NEMA PREMIUM, TENV, ROUND BODY C-FACE [WFNV/WNV]**

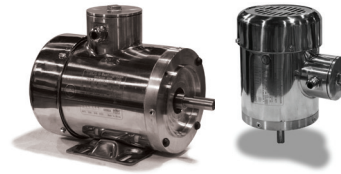

HP	RPM	FRAME	FL EFF %	FL PF %	FL AMPS (460V)	APPROX. SHIPPING WT. (lbs.)	FOOTED C-FACE		ROUND BODY C-FACE	
							CATALOG NUMBER	LIST PRICE (\$)	CATALOG NUMBER	LIST PRICE (\$)
1/2	3600	56C	75.0	79.0	0.80	37	WFN0/52C	975	WFNV0/52C	975
1/2	1800	56C	80.0	65.0	0.90	37	WFN0/54C	980	WFNV0/54C	980
3/4	3600	56C	77.0	84.0	1.10	39	WFN0/72C	1,163	WFNV0/72C	1,163
3/4	1800	56C	80.0	68.0	1.30	39	WFN0/74C	1,111	WFNV0/74C	1,111
1	3600	56C	77.0	90.0	1.40	37	WFN0012C	1,346	WFNV0012C	1,346
1	3600	143/145TC	77.0	90.0	1.40	46	WN0012C	1,697	WNV0012C	1,697
1	1800	145TC	85.5	70.0	1.60	44	WFN0014C	1,495	WFNV0014C	1,495
1	1800	143/145TC	85.5	70.0	1.60	46	WN0014C	1,944	WNV0014C	1,944
1.5	3600	B56C	84.0	90.0	2.00	45	WFN1/52C	1,313	WFNV1/52C	1,313
1.5	3600	143/145TC	84.0	90.0	2.00	50	WN1/52C	2,799	WNV1/52C	2,799
1.5	1800	56C/56H	86.5	73.0	2.20	55	WFN1/54C	1,393	WFNV1/54C	1,393
1.5	1800	145TC	86.5	73.0	2.20	58	WN1/54C	2,824	WNV1/54C	2,824
2	3600	C56C	85.5	91.0	2.40	52	WFN0022C	1,594	WFNV0022C	1,594
2	3600	145TC	85.5	91.0	2.40	58	WN0022C	2,670	WNV0022C	2,670
2	1800	C56C	86.5	75.0	3.00	62	WFN0024C	1,807	WFNV0024C	1,807
2	1800	145TC	86.5	75.0	3.00	65	WN0024C	2,870	WNV0024C	2,870
3	3600	182/184TC	86.5	88.0	4.10	80	WN0032C	3,933	WNV0032C	3,933
3	1800	182/184TC	86.5	78.0	4.00	115	WN0034C	3,727	WNV0034C	3,727

Notes:

1. Select catalog numbers have changed in order to follow the following format:
 "WFPV" = TEFC 56 Frame Round Body C-Face
 "WFP" = TEFC F3 56 Frame Footed C-Face
 "WPV" = TEFC F#140TC - F#210TC Round Body C-Face
 "WP" = TEFC F3 F#140TC - F#210TC Footed C-Face
 "WFRV" = TEFC 56 Frame Round Body C-Face
 "WFR" = TEFC F1 56 Frame Footed C-Face
 "WRV" = TEFC F#140TC - F#210TC Round Body C-Face
 "WR" = TEFC F1 F#140TC - F#210TC Footed C-Face
 "WFNV" = TENV 56 Frame Round Body C-Face
 "WFN" = TENV F1 56 Frame Footed C-Face
 "WNV" = TENV F#140TC - F#180TC Round Body C-Face
 "WN" = TENV F1 F#140TC - F#180TC Footed C-Face
 "-E" At the end of Catalog Numbers adds Encapsulation to the motor.
2. Data subject to change without notice.

TEXP EXPLOSION PROOF FAMILY



CCO02A

**AEHHXV/AEHHXU, NEMA PREMIUM [XP]****AEHHXG/AEHHXF, NEMA PREMIUM, FOOTED C-FACE (1 HP - 100 HP)[XP_C]****AEUHXG/AEUHXF, NEMA PREMIUM, ROUND BODY C-FACE (1 HP - 75 HP)[XPV_C]**

Effective: 01-01-2022

Supersedes: 07-06-2021

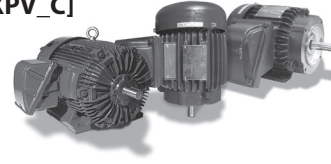

APPLICATIONS:

- Grain Elevators
- Applications Where Explosive Gases are Present
- Blowers
- Pumps
- Applications Where Explosive Dusts/ Grains are Present

FEATURES:

- Output Range: 1 - 400 HP
- Speed: 3600, 1800, 1200, 900 RPM
- Enclosure: Totally Enclosed Fan Cooled - Explosion Proof (IP55)
- Voltage: 230/460V (Usable on 208V); 150HP and Larger is 460V Only¹
- Three Phase, 60 Hz, 1.15 Service Factor (Continuous); 50 Hz, 1.0 Service Factor (Continuous)
- Class I, Div. 1, Group C & D and Class II, Groups E, F and G - Temp Code T3B Up to and Including F# 256T
- Class I, Div. 1, Group D and Class II, Groups E, F and G - Temp Code T3B for F# 284T and Larger
- UL File: E84757
- CSA File: #64671
- Class F Insulation
- Class B Temperature Rise
- NEMA Design B Torques
- Standard with Klixon 9700K Temperature Limiting Switch, 1 per Phase
- Grounding Terminal Inside Main Conduit Box
- Oversized Main Conduit Box Rotatable in 90 Degree Increments - F1 Mounted
- Dual Drilled Back Feet on 447/9 and 5007/9 Frames
- Designed for 40°C Ambient Temperature²
- Designed for 3300 ft. Elevation³
- Bi-Directional Rotation
- Cast Iron Frame, Fan Cover, End Brackets and Main Conduit Box
- Capable of Withstanding Explosion Force as Required by UL
- Stainless Steel Breather Drains with Bronze Filters (For Horizontal Mount Only)
- 1045 Carbon Steel Shaft
- Aluminum Die Cast Squirrel Cage Rotor Construction through 449 Frame; Fabricated Copper Bar on 5000 Frame
- Aluminum Die Cast Squirrel Cage Rotor Construction
- Paint System: Phenolic Rust Proof Base Plus Polyurethane Top Coat
- Paint Color: Dark Blue - Munsell 5 PB 4.5/2
- Double Shielded Bearings Pre-Packed with MULTEMP SRL for F# 140T - 280T (Non-regreasable)
- High Quality Ball (or Roller) Bearings Regreasable with Mobil Polyrex™ EM for F# 280TS and Larger
- Bronze Flinger on Both Ends
- Cast Iron Inner and Outer Bearing Caps for F#280TS and Larger
- Stainless Steel Nameplate
- Suitable for Inverter Use per NEMA MG-1 Part 31.4.4.2^(4,5)
- UL Listed for Inverter Duty^{4,5}
- Inverter Duty Magnet Wire Capable of Withstanding Voltage Spikes of up to 2200 Volts
- Inverter Duty Speed Ranges:

VT = 3 - 60 Hz	CT for 140T - 210T Frames = 10 - 60 Hz
CT for 250T - 320T Frames = 13 - 60 Hz	CT for 360T - 440T Frames = 16 - 60 Hz
CT for 5000 Frames = 15 - 60 Hz	VT for 5000 Frames = 3 - 60 Hz
- 9 Leads for 5 HP and Smaller
- 12 Leads for 7.5 HP to 125 HP
- 6 Leads for 150 HP and Larger

EXTRAS/ OPTIONS:

Please refer to pages 147 - 152 for common modifications that can be performed.

Notes:

1. Available in 575V. TWMC carries minimal 575V stock; please check availability to ensure required motors are in stock. Ratings may be available from our Canadian warehouses and/or our factory. Pricing and leadtime may vary.
2. Consult a Stock Product Application Specialist for suitability in higher ambient environments.
3. Consult a Stock Product Application Specialist for suitability at higher elevations.
4. Motor Service Factor is 1.0 when operated on a VFD.
5. Precautions should be taken to eliminate or reduce shaft currents that may be imposed on the motor by the VFD as stated per NEMA MG-1, Part 31.
6. Extras/Modification options are limited on TEXP Products. Available options: M2X, M8B, M11 (449T frame and below, maybe all), M16; M8; M18A; M15; M14; M21A; M22.

TEXP EXPLOSION PROOF

AEHHXV/AEHHXU, NEMA PREMIUM [XP]



CCO2A



Effective: 01-01-2022

Supersedes: 07-06-2021

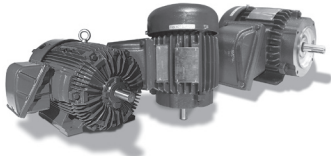

CATALOG NUMBER	HP	RPM	FRAME	FL EFF %	FL PF %	FL AMPS (460V)	APPROX. SHIPPING WT. (lbs.)	LIST PRICE (\$)
XP0014	1	1800	143T	85.5	68.0	1.61	64	867
XP0016	1	1200	145T	82.5	66.0	1.72	93	1,004
XP0018	1	900	182T	77.0	58.5	2.08	108	1,402
XP1/52	1.5	3600	143T	84.0	84.0	1.99	78	987
XP1/54	1.5	1800	145T	86.5	75.5	2.15	80	969
XP1/56	1.5	1200	182T	87.5	63.0	2.55	125	1,088
XP1/58	1.5	900	184T	78.5	60.5	2.96	120	1,571
XP0022	2	3600	145T	85.5	87.0	2.52	68	1,020
XP0024	2	1800	145T	86.5	78.0	2.78	80	981
XP0026	2	1200	184T	88.5	69.0	3.07	148	1,257
XP0028	2	900	213T	84.0	64.0	3.48	187	2,292
XP0032	3	3600	182T	87.5	90.0	3.57	130	1,176
XP0034	3	1800	182T	89.5	81.0	3.87	135	1,180
XP0036	3	1200	213T	89.5	80.0	3.92	240	1,590
XP0038	3	900	215T	85.5	66.0	4.98	211	2,627
XP0052	5	3600	184T	88.5	91.0	5.81	153	1,452
XP0054	5	1800	184T	89.5	84.0	6.23	145	1,366
XP0056	5	1200	215T	90.2	81.0	6.41	235	2,047
XP0058	5	900	254T	86.5	72.0	7.52	330	3,367
XP7/52	7.5	3600	213T	89.5	87.0	9.02	235	1,967
XP7/54	7.5	1800	213T	91.7	86.5	8.85	200	1,924
XP7/56	7.5	1200	254T	91.0	82.0	9.41	365	2,598
XP7/58	7.5	900	256T	86.5	81.5	11.4	376	4,011
XP0102	10	3600	215T	90.2	87.0	11.9	250	2,070
XP0104	10	1800	215T	91.7	87.5	11.7	265	2,241
XP0106	10	1200	256T	91.0	81.5	12.6	420	3,183
XP0108	10	900	284T	89.5	73.5	14.2	488	5,092
XP0152	15	3600	254T	91.0	92.0	16.8	400	2,619
XP0154	15	1800	254T	92.4	85.0	17.9	390	3,010
XP0156	15	1200	284T	91.7	83.0	18.5	575	4,346
XP0158	15	900	286T	89.5	78.0	20.1	530	5,800
XP0202	20	3600	256T	91.0	92.0	22.4	440	3,531
XP0204	20	1800	256T	93.0	85.5	23.6	455	3,528
XP0206	20	1200	286T	91.7	84.0	24.3	600	4,927
XP0208	20	900	324T	90.2	81.0	25.6	708	7,864
XP0252	25	3600	284TS	91.7	92.0	27.7	460	4,150
XP0254	25	1800	284T	93.6	85.0	29.4	585	4,361
XP0256	25	1200	324T	93.0	83.0	30.3	825	6,068
XP0258	25	900	326T	90.2	79.5	32.6	781	8,801
XP0302	30	3600	286TS	92.4	92.0	33.0	583	4,899
XP0304	30	1800	286T	93.6	85.5	34.3	565	5,050
XP0306	30	1200	326T	93.0	83.0	36.4	787	7,416
XP0308	30	900	364T	91.7	77.5	39.5	946	11,336
XP0402	40	3600	324TS	93.0	91.0	44.3	805	6,909
XP0404	40	1800	324T	94.1	85.5	46.6	708	7,179
XP0406	40	1200	364T	94.1	86.0	46.3	980	9,750
XP0408	40	900	365T	91.7	76.5	53.4	1,019	13,766
XP0502	50	3600	326TS	93.6	91.0	55.0	890	8,666
XP0504	50	1800	326T	94.5	85.5	57.9	925	8,272
XP0506	50	1200	365T	94.1	83.5	59.6	1,125	9,843
XP0508	50	900	404T	93.0	80.5	62.5	1,287	12,369

Notes:

1. Data subject to change without notice.

TEXP EXPLOSION PROOF

AEHHXV/AEHHXU, NEMA PREMIUM [XP]



Effective: 01-01-2022

Supersedes: 07-06-2021

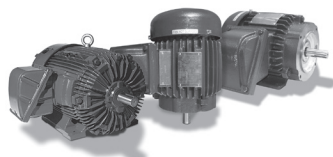

CATALOG NUMBER	HP	RPM	FRAME	FL EFF %	FL PF %	FL AMPS (460V)	APPROX. SHIPPING WT. (lbs.)	LIST PRICE (\$)
XP0602	60	3600	364TS	93.6	93.0	64.5	1,015	10,265
XP0604	60	1800	364T	95.0	88.0	67.2	1,010	10,233
XP0606	60	1200	404T	94.5	86.0	69.1	1,322	14,276
XP0608	60	900	405T	93.0	81.0	74.6	1,408	17,399
XP0752	75	3600	365TS	93.6	93.0	80.7	1,085	12,209
XP0754	75	1800	365T	95.4	88.0	83.6	1,110	11,995
XP0756	75	1200	405T	94.5	86.5	85.9	1,540	16,767
XP0758	75	900	444T	93.0	81.0	93.2	1,650	21,266
XP1002	100	3600	405TS	94.5	92.0	108	1,495	18,909
XP1004	100	1800	405T	95.4	90.0	109	1,545	16,764
XP1006	100	1200	444T	95.0	83.5	118	1,920	21,461
XP1006R	100	1200	444T	95.0	83.5	118	1,920	21,461
XP1008	100	900	445T	93.0	81.0	124	1,800	22,723
XP1252	125	3600	444TS	95.0	86.0	143	1,800	24,337
XP1254	125	1800	444T	95.4	85.0	144	1,970	22,597
XP1254R	125	1800	444T	95.4	85.0	144	1,970	22,597
XP1256	125	1200	445T	95.0	84.0	147	2,100	28,746
XP1256R	125	1200	445T	95.0	84.0	147	2,100	28,746
XP1258	125	900	447/449T	93.6	82.5	152	2,500	47,548
XP1258R	125	900	447/449T	93.6	82.5	152	2,500	47,548
XP1502	150	3600	445TS	95.0	87.0	170	1,940	28,250
XP1504	150	1800	445T	95.8	85.0	173	2,120	27,448
XP1504R	150	1800	445T	95.8	85.0	173	2,120	27,448
XP1506	150	1200	447/449T	95.8	84.5	174	2,120	45,839
XP1506R	150	1200	447/449T	95.8	84.5	174	2,120	45,839
XP1508	150	900	449T	93.6	82.5	182	2,880	48,358
XP1508R	150	900	447/449T	93.6	82.5	182	2,880	48,358
XP2002	200	3600	447/449TS	95.4	89.0	221	2,300	43,148
XP2004	200	1800	447/449T	96.2	87.0	224	2,620	43,032
XP2006	200	1200	447/449T	95.8	85.0	230	2,850	47,471
XP2006R	200	1200	447/449T	95.8	85.0	230	2,450	47,471
XP2008	200	900	5007/5009B	94.1	80.4	248	3,920	61,024
XP2008R	200	900	5007/5009C	94.1	80.4	248	3,920	61,024
XP2502	250	3600	447/449TS	95.8	89.8	272	2,720	45,417
XP2504	250	1800	447/449T	96.2	88.0	277	2,870	46,336
XP2506	250	1200	5007/5009B	95.8	87.0	281	4,010	67,963
XP2506R	250	1200	5007/5009C	95.8	87.0	281	4,010	67,963
XP2508	250	900	5007/5009B	94.5	81.0	306	4,360	65,740
XP2508R	250	900	5009C	94.5	81.0	306	4,360	65,740
XP3002	300	3600	447/449TS	95.8	90.2	325	2,920	47,486
XP3004	300	1800	447/449T	96.2	88.0	332	2,950	47,062
XP3006	300	1200	5007/5009B	95.8	87.3	336	4,310	71,507
XP3006R	300	1200	5007/5009C	95.8	87.3	336	4,310	71,507
XP3502	350	3600	5007/5009A	95.8	88.0	389	4,200	65,581
XP3504	350	1800	5007/5009B	96.2	87.7	388	4,400	65,132
XP3506	350	1200	5007/5009B	95.8	87.4	391	4,520	75,178
XP3506R	350	1200	5007/5009C	95.8	87.4	391	4,520	75,178
XP4002	400	3600	5007/5009A	95.8	88.3	443	4,350	96,055
XP4004	400	1800	5007/5009B	96.2	87.7	444	4,500	89,362

Notes:

1. Data subject to change without notice.

TEXP EXPLOSION PROOF



AEHHXG/AEHHXF, NEMA PREMIUM, FOOTED C-FACE (1 HP - 100 HP)[XP_C]
 AEUHXG/AEUHXF, NEMA PREMIUM, ROUND BODY C-FACE (1 HP - 75 HP)[XPV_C]

Effective: 01-01-2022
 Supersedes: 07-06-2021

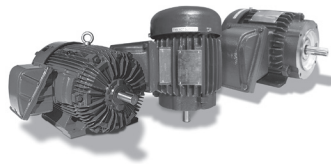

HP	RPM	FRAME	FL EFF %	FL PF %	FL AMPS (460V)	APPROX. SHIPPING WT. (lbs.)	FOOTED C-FACE		ROUND BODY C-FACE	
							CATALOG NUMBER	LIST PRICE (\$)	CATALOG NUMBER	LIST PRICE (\$)
1	1800	143TC	85.5	73.0	1.5	64	XP0014C	1,224	XPV0014C	1,085
1	1200	145TC	82.5	65.5	1.7	93	XP0016C	1,397	XPV0016C	1,236
1.5	3600	143TC	84.0	83.5	2.0	78	XP1/52C	1,372	XPV1/52C	1,213
1.5	1800	145TC	86.5	78.0	2.1	80	XP1/54C	1,321	XPV1/54C	1,168
1.5	1200	182TC	87.5	63.5	2.5	125	XP1/56C	1,470	XPV1/56C	1,301
2	3600	145TC	86.5	86.0	2.5	68	XP0022C	1,423	XPV0022C	1,260
2	1800	145TC	86.5	78.0	2.8	80	XP0024C	1,365	XPV0024C	1,208
2	1200	184TC	88.5	70.5	3.0	148	XP0026C	1,688	XPV0026C	1,494
3	3600	182TC	88.5	90.0	3.5	130	XP0032C	1,584	XPV0032C	1,402
3	1800	182TC	89.5	84.0	3.7	135	XP0034C	1,594	XPV0034C	1,411
3	1200	213TC	89.5	78.0	4.0	240	XP0036C	2,207	XPV0036C	1,784
5	3600	184TC	88.5	92.5	5.7	153	XP0052C	1,862	XPV0052C	1,648
5	1800	184TC	89.5	85.5	6.1	145	XP0054C	1,850	XPV0054C	1,636
5	1200	215TC	91.0	82.5	6.2	235	XP0056C	2,662	XPV0056C	2,354
7.5	3600	213TC	91.0	89.0	8.7	235	XP7/52C	2,495	XPV7/52C	2,207
7.5	1800	213TC	91.7	86.5	8.9	200	XP7/54C	2,607	XPV7/54C	2,308
7.5	1200	254TC	91.0	80.5	9.6	365	XP7/56C	3,279	XPV7/56C	2,903
10	3600	215TC	91.0	89.5	11.5	250	XP0102C	3,115	XPV0102C	2,486
10	1800	215TC	91.7	88.0	11.6	241	XP0104C	3,034	XPV0104C	2,685
10	1200	256TC	91.0	80.5	12.8	420	XP0106C	3,986	XPV0106C	3,527
15	3600	254TC	92.4	91.5	16.6	400	XP0152C	3,654	XPV0152C	3,390
15	1800	254TC	92.4	88.0	17.3	390	XP0154C	3,663	XPV0154C	3,500
15	1200	284TC	92.4	83.5	18.2	575	XP0156C	5,408	XPV0156C	4,786
20	3600	256TC	92.4	92.5	21.9	440	XP0202C	4,403	XPV0202C	3,895
20	1800	256TC	93.0	87.5	23.0	455	XP0204C	4,419	XPV0204C	3,910
20	1200	286TC	91.7	84.0	24.3	600	XP0206C	6,153	XPV0206C	5,698
25	3600	284TSC	92.4	91.0	27.8	460	XP0252C	5,294	XPV0252C	4,901
25	1800	284TC	93.6	86.0	29.1	585	XP0254C	5,405	XPV0254C	5,005
25	1200	324TC	93.0	83.0	30.3	825	XP0256C	8,415	XPV0256C	7,792
30	3600	286TSC	92.4	91.0	33.2	583	XP0302C	6,322	XPV0302C	5,853
30	1800	286TC	93.6	87.5	34.3	565	XP0304C	6,292	XPV0304C	5,825
30	1200	326TC	93.0	80.5	37.5	787	XP0306C	9,763	XPV0306C	9,039
40	3600	324TSC	94.1	90.0	44.2	805	XP0402C	8,976	XPV0402C	7,951
40	1800	324TC	94.1	86.0	46.3	708	XP0404C	9,014	XPV0404C	8,346
40	1200	364TC	94.1	86.5	46.0	980	XP0406C	12,911	XPV0406C	11,955
50	3600	326TSC	94.1	91.0	54.7	890	XP0502C	10,390	XPV0502C	9,621
50	1800	326TC	94.5	87.0	56.9	925	XP0504C	10,233	XPV0504C	9,476
50	1200	365TC	94.1	86.0	57.8	1,125	XP0506C	15,747	XPV0506C	14,580
60	3600	364TSC	94.1	93.0	64.2	1,015	XP0602C	11,894	XPV0602C	12,102
60	1800	364TC	95.0	86.5	68.4	1,010	XP0604C	13,383	XPV0604C	12,393
60	1200	404TC	94.5	87.0	68.3	1,322	XP0606C	18,500	XPV0606C	17,905
75	3600	365TSC	94.5	93.0	79.9	1,085	XP0752C	16,144	XPV0752C	15,675
75	1800	365TC	95.4	86.5	85.1	1,110	XP0754C	16,139	XPV0754C	14,942
75	1200	405TC	94.5	86.5	85.9	1,540	XP0756C	18,884	XPV0756C	18,278
100	3600	405TSC	95.4	92.0	107	1,495	XP1002C	20,162	~	~
100	1800	405TC	95.4	87.5	112	1,545	XP1004C	20,075	~	~

Notes:

1. Data subject to change without notice.

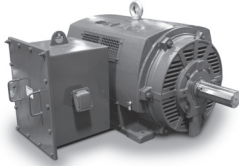

APPLICATIONS:

■ Pumps

■ Fans & Blowers

■ Compressors

FEATURES:

- Output Range: 100 - 2000 HP
- Speed: 3600, 1800, 1200, 900 RPM¹
- Enclosure: Weather Protected Type I (WPI), (IP23)
- Voltage: 2300/4000V
- Three Phase, 60 Hz, 1.15 Service Factor (Continuous)
- Standard Features: 100 Ohm Platinum Stator RTD's (2 per Phase), Space Heaters (120V)
- Standard Features: Pre-Drilled & Plugged Bearing Bracket for 100 Ohm Platinum Bearing RTD's on 5000 Frames & Above
- Standard Features: Pre-Drilled & Spot Faced on Top of End Bracket for Vibration Detectors on 5000 Frames and Above
- Class F Insulation
- Class B Temperature Rise
- NEMA Design B Torques
- Oversized Main Conduit Box Rotatable in 90 Degree Increments
Fully Gasketed with NPT Threaded Entrance - F1 Mounted
- Designed for 40°C Ambient Temperature²
- Designed for 3300 ft. Elevation³
- Rotation: F#449-449: Bi-Directional. F#5000-5813: Bi-Directional on 4,6,8P, Except 2P, which is Unidirectional, Counter-Clockwise (CCW) facing the Drive End
- 1045 Carbon Steel Shaft
- Aluminum Die Cast Squirrel Cage Rotor Construction for F#449T and Below
- Squirrel Cage Copper or Copper Alloy Bar Rotor Construction for F#5000 and Larger
- Paint System: Phenolic Rust Proof Base Plus Polyurethane Top Coat
- Paint Color: Dark Gray - Munsell 7.5B 3.5/0.5
- High Quality Ball (or Roller) Bearings Regreasable with Mobil Polyrex™ EM
- Insulated Non-Drive End Bearing on 3600 RPM Motors; 600 HP and Larger
- Metal Flinger on Both Ends
- Cast Iron Inner and Outer Bearing Caps
- Grounding Terminal Inside Main Box and on Motor Foot
- Stainless Steel Nameplate
- Suitable for Inverter Use per NEMA MG-1 Part 31.4.4.2^(4,5)
- Inverter Duty Speed Range: 20:1 Variable Torque, 10:1 Constant Torque (350 HP and Larger are 3:1 Constant Torque)
- 6 Leads, Wye Delta Capable
- Motors are CSA Approved
- 2-Pole motors, 600HP and larger, are Form Wound and Insulated Non-Drive End Bearing
- Spotface ¼ -28UNF Tap x 12mm Deep on Top of Both End Brackets with VB300 Vibration Sensor on 5000 Frames and Larger

EXTRAS/ OPTIONS:

Please refer to pages 147 - 152 for common modifications that can be performed.

Notes:

1. Slower speeds available as Made to Order.
2. Consult a Stock Product Application Specialist for suitability in higher ambient environments, and for variable and constant torque speed ranges.
3. Consult a Stock Product Application Specialist for suitability at higher elevations.
4. Motor service factor is 1.0 when operated on a VFD.
5. Precautions should be taken to eliminate or reduce shaft currents that may be imposed on the motor by the VFD as stated per NEMA MG-1. Part 31.
An isolation transformer or other method of mitigating common mode voltages from motor terminals must be utilized. Please refer to page 184 to check out our accompanying TeamMaster™ starters.

GLOBAL MAX WPI



AMHGTK, PREMIUM EFFICIENCY, MEDIUM VOLTAGE [PG]

Effective: 01-01-2022
Supersedes: 07-06-2021

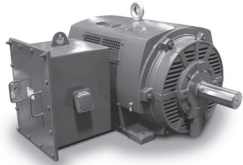

CATALOG NUMBER	HP	RPM	FRAME	FL EFF %	FL PF %	FL AMPS (2300V)	APPROX. SHIPPING WT. (lbs.)	LIST PRICE (\$)
PG1002	100	3600	447TS	92.0	87.2	23.0	1,760	25,393
PG1004	100	1800	447T	93.7	82.5	24.0	2,050	28,865
PG1006	100	1200	447T	94.6	78.1	25.0	1,920	33,611
PG1008	100	900	447T	93.2	74.9	27.0	2,310	37,153
PG1252	125	3600	447TS	93.1	88.4	28.0	1,800	29,370
PG1254	125	1800	447T	94.2	80.5	31.0	2,100	32,350
PG1256	125	1200	449T	94.7	78.9	31.0	2,120	41,454
PG1258	125	900	449T	93.3	77.0	33.0	2,530	43,131
PG1502	150	3600	447TS	93.1	88.0	34.0	1,870	32,943
PG1504	150	1800	449T	94.8	83.9	35.0	2,360	37,611
PG1506	150	1200	449T	94.8	77.9	38.0	2,180	45,102
PG1508	150	900	449T	93.4	75.7	40.0	3,260	47,521
PG2002	200	3600	449TS	93.7	87.4	46.0	1,900	39,334
PG2004	200	1800	449T	94.9	82.3	48.0	2,380	41,931
PG2006	200	1200	449T	94.9	77.9	51.0	2,270	45,557
PG2008	200	900	5009B	93.5	73.0	55.0	3,550	55,449
PG2502	250	3600	449TS	94.5	89.3	55.0	2,020	45,283
PG2504	250	1800	449T	95.0	82.2	60.0	2,490	47,745
PG2506	250	1200	449T	95.0	78.4	63.0	2,340	53,240
PG2508	250	900	5009B	93.6	75.5	66.0	3,990	67,878
PG3002	300	3600	449TS	94.5	89.1	67.0	2,100	49,160
PG3004	300	1800	449T	95.0	83.8	71.0	2,550	47,929
PG3006	300	1200	449T	95.0	77.7	76.0	2,490	56,081
PG3008	300	900	5011B	93.7	75.5	79.0	4,380	79,504
PG3502	350	3600	5009A	94.5	88.1	79.0	3,580	62,098
PG3504	350	1800	5009B	95.0	84.3	82.0	3,330	59,573
PG3506	350	1200	5009B	95.0	76.5	90.0	3,770	67,850
PG3508	350	900	5011B	93.8	75.0	93.0	4,710	86,352
PG4002	400	3600	5009A	94.5	87.9	90.0	3,700	65,866
PG4004	400	1800	5009B	95.0	84.0	94.0	3,420	62,101
PG4006	400	1200	5009B	95.1	76.0	104	3,850	72,376
PG4008 ³	400	900	5012B	93.9	73.5	109	4,820	95,138
PG4502	450	3600	5009A	94.5	87.0	102	3,800	69,201
PG4504	450	1800	5009B	95.0	84.1	105	3,520	63,541
PG4506	450	1200	5011B	95.2	75.0	118	3,720	78,150
PG4508	450	900	5810B	94.0	78.5	114	6,160	106,831
PG5002	500	3600	5011A	94.5	89.2	111	3,900	73,097
PG5004	500	1800	5009B	95.0	84.8	116	3,720	68,549
PG5006	500	1200	5011B	95.3	77.0	128	3,920	82,245
PG5008	500	900	5810B	94.1	77.7	128	6,450	111,027
PG6002	600	3600	5011A	95.0	89.2	133	4,000	80,876
PG6004	600	1800	5011B	95.4	85.5	138	3,770	74,427
PG6006	600	1200	5011B	95.4	77.0	153	4,250	88,556
PG6008	600	900	5810B	94.2	78.0	153	6,600	116,526
PG7002	700	3600	5011A	95.0	89.6	154	4,200	82,515
PG7004	700	1800	5011B	95.4	85.7	161	4,100	81,195
PG7006 ³	700	1200	5012B	95.5	77.3	178	4,850	96,195
PG7008	700	900	5811B	94.3	78.0	178	6,880	123,390
PG8002	800	3600	5011A	95.0	88.6	178	4,400	86,515
PG8004 ³	800	1800	5012B	95.4	85.9	183	4,300	85,987
PG8006	800	1200	5810B	95.6	81.0	193	5,940	106,947
PG8008	800	900	5811B	94.4	79.0	201	7,100	130,205
PG9002 ³	900	3600	5012A	95.0	90.3	197	4,600	100,283
PG9004 ³	900	1800	5012B	95.4	85.5	207	4,400	95,409
PG9006	900	1200	5810B	95.7	81.5	216	6,230	116,496
PG9008	900	900	5812B	94.5	79.1	225	7,700	140,400
PG10002 ³	1000	3600	5012A	95.0	88.5	223	4,730	100,595
PG10004	1000	1800	5810B	95.5	87.9	223	6,890	86,737
PG10006	1000	1200	5811B	95.8	82.3	238	6,980	127,104
PG12502	1250	3600	5810A	95.4	88.5	278	5,740	114,968
PG12504	1250	1800	5811B	95.8	86.1	284	7,070	117,544
PG12506	1250	1200	5812B	95.9	82.9	294	7,660	140,975
PG15004	1500	1800	5812B	95.8	86.7	339	7,790	136,863
PG17504	1750	1800	5813B	95.8	87.1	393	8,390	150,554
PG20004	2000	1800	5813B	95.9	86.4	452	8,400	164,238

Notes:

1. Data subject to change without notice.
2. All motors are NEMA B torque.
3. F#5012 dual drilled for 5012/11 mounting holes.

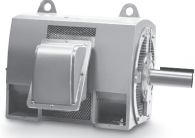

APPLICATIONS:

■ Pumps

■ Fans & Blowers

■ Compressors

FEATURES:

- Output Range: 100 - 1000 HP
- Speed: 3600, 1800, 1200, 900 RPM¹
- Enclosure: Weather Protected Type I (WPI), (IP23)
- Voltage: 2300/4160V
- Three Phase, 60 Hz, 1.15 Service Factor (Continuous)
- Standard Features: 100 Ohm Platinum Stator RTD's (2 per Phase), Space Heaters (120V)
- Class F Insulation
- Class B Temperature Rise
- NEMA Design B Torques
- Oversized Main Conduit Box Rotatable in 90 Degree Increments Fully Gasketed with NPT Threaded Entrance - F1 Mounted
- Designed for 40°C Ambient Temperature²
- Designed for 3300 ft. Elevation³
- Rotation: Bi-Directional Except 2 Pole which is Counter-Clockwise (CCW) facing the Drive End
- Cast Iron Frame and End Brackets
- 1045 Carbon Steel Shaft
- Aluminum Die Cast Squirrel Cage Rotor Construction for F#449T and Below
- Squirrel Cage Copper or Copper Alloy Bar Rotor Construction for F#5000 and Above
- Paint System: Phenolic Rust Proof Base Plus Polyurethane Top Coat
- Paint Color: Dark Gray - Munsell 7.5B 3.5/0.5
- High Quality Ball (or Roller) Bearings Regreasable with Mobil Polyrex™ EM
- Insulated Non-Drive End Bearing on 2 Pole Motors; 600 HP and Larger
- Metal Flinger on Both Ends
- Cast Iron Inner and Outer Bearing Caps
- Grounding Terminal Inside Main Box and on Motor Foot
- Stainless Steel Nameplate
- Suitable for Inverter Use per NEMA MG-1 Part 31.4.4.2 ^(4,5)
- Inverter Duty Speed Range: 20:1 Variable Torque, 10:1 Constant Torque (350 HP and Larger are 3:1 Constant Torque)
- 6 Leads
- Motors are CSA Approved
- Spotface ¼ -28UNF Tap x 12mm Deep on Top of Both End Brackets with VB300 Vibration Sensor on 5000 Frames and Larger

EXTRAS/ OPTIONS:

Please refer to pages 147 - 152 for common modifications that can be performed.

Notes:

1. Slower speeds available as Made to Order.
2. Consult a Stock Product Application Specialist for suitability in higher ambient environments, and for variable and constant torque speed ranges.
3. Consult a Stock Product Application Specialist for suitability at higher elevations.
4. Motor service factor is 1.0 when operated on a VFD.
5. Precautions should be taken to eliminate or reduce shaft currents that may be imposed on the motor by the VFD as stated per NEMA MG-1, Part 31. An isolation transformer or other method of mitigating common mode voltages from motor terminals must be utilized. Please refer to page 211 to check out our accompanying TeamMaster™ starters.

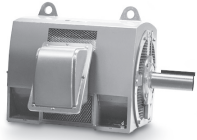

CATALOG NUMBER	HP	RPM	FRAME	FL EFF %	FL PF %	FL AMPS (2300V)	APPROX. SHIPPING WT. (lbs.)	LIST PRICE (\$)
P1002	100	3600	444TS	91.0	90.2	22.8	1,292	21,746
P1004	100	1800	444T	91.0	87.5	23.5	1,680	21,302
P1006	100	1200	445T	91.0	80.0	25.7	2,205	28,034
P1006R	100	1200	445T	91.0	80.0	25.7	2,205	28,034
P1252	125	3600	444TS	91.0	90.2	28.5	1,370	25,621
P1254	125	1800	444T	91.0	87.5	29.4	1,490	24,087
P1256	125	1200	447T	91.7	80.0	32.0	2,139	34,789
P1256R	125	1200	447T	91.7	80.0	32.0	2,139	34,789
P1502	150	3600	445TS	91.7	90.2	34.0	1,450	29,014
P1504	150	1800	445T	91.7	87.5	35.0	1,645	28,240
P1506R	150	1200	449T	91.7	80.0	38.0	2,547	39,654
P2002	200	3600	447TS	91.7	90.2	45.0	1,733	32,295
P2004	200	1800	447T	91.7	87.5	47.0	2,050	31,054
P2004R	200	1800	447T	91.7	87.5	47.0	2,050	31,582
P2006	200	1200	5007C	91.7	81.5	50.1	3,057	41,819
P2502	250	3600	449TS	92.4	91.0	56.0	2,095	38,489
P2504	250	1800	449T	92.4	87.5	58.0	2,668	35,779
P2506	250	1200	5007B	92.4	84.0	60.3	3,362	48,944
P2506R	250	1200	5007C	92.4	84.0	60.3	3,362	48,944
P3004	300	1800	5007B	93.0	88.5	68.3	3,255	43,597
P3006	300	1200	5009B	93.0	84.0	71.9	3,945	54,275
P3006R	300	1200	5009C	93.0	84.0	71.9	3,945	54,275
P3008R	300	900	5808C	93.0	80.0	75.5	4,515	72,277
P3502	350	3600	5007A	93.0	90.2	78.1	2,991	52,051
P3504	350	1800	5007B	93.6	88.5	79.1	3,465	49,825
P4004	400	1800	5009B	93.6	89.5	89.4	4,065	54,787
P4006	400	1200	5808B	93.6	85.5	93.6	5,055	67,478
P4006R	400	1200	5808C	93.6	85.5	93.6	5,055	67,478
P4008	400	900	5808B	93.0	81.5	98.8	5,250	77,853
P4008R	400	900	5808C	93.0	81.5	98.8	5,250	77,853
P4502	450	3600	5808A	93.6	91.0	98.9	5,145	63,172
P4504	450	1800	5808B	93.6	88.5	102	4,200	58,720
P4506	450	1200	5808B	93.6	85.5	105	5,640	71,172
P4506R	450	1200	5808C	93.6	85.5	105	5,640	71,172
P5002	500	3600	5808A	94.1	91.0	109	4,680	68,513
P5004	500	1800	5808B	94.1	89.5	111	5,115	63,172
P5006	500	1200	5808B	94.1	85.5	116	6,038	76,515
P5006R	500	1200	5808C	94.1	85.5	116	6,038	76,515
P5008	500	900	5810B	93.6	82.5	121	6,325	89,861
P6002	600	3600	5808A	94.5	91.3	130	5,135	76,515
P6004	600	1800	5808B	94.1	89.5	133	5,418	71,172
P6006R	600	1200	5810C	94.1	86.5	138	6,120	84,081
P6008	600	900	6806B	94.1	84.0	142	6,983	102,322
P7002	700	3600	5810A	94.5	91.7	151	5,410	82,749
P7004	700	1800	5808B	94.5	90.2	154	5,355	78,302
P7004R	700	1800	5808B	94.5	90.2	154	5,355	78,302
P7006R	700	1200	5810C	94.5	86.5	160	6,625	91,193
P7008	700	900	6808B	94.5	84.0	165	7,860	113,000
P8002	800	3600	5810A	95.0	91.7	172	5,475	86,750
P8004	800	1800	5810B	94.5	90.2	176	5,828	84,533
P8006	800	1200	6806B	94.5	86.5	183	7,770	105,140
P8006R	800	1200	6806C	94.5	86.5	183	7,770	105,140
P8008R	800	900	6808C	94.5	84.5	188	8,820	125,012
P9002	900	3600	5810A	95.0	91.7	193	5,685	102,288
P9004	900	1800	5810B	95.0	90.2	197	6,143	91,648
P9006	900	1200	6806B	95.0	86.5	205	8,190	109,883
P10002	1000	3600	5810A	95.0	90.2	214	5,950	114,553
P10004	1000	1800	6806B	95.0	90.2	219	7,750	98,772
P10006R	1000	1200	6808C	95.0	86.5	228	8,610	130,297

Notes:

1. Data subject to change without notice.
2. "R" at the end of the Catalog number means motor has Roller Bearing on the Drive End.

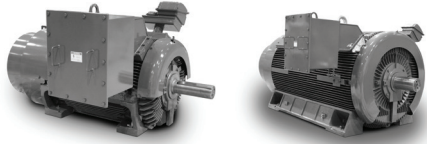

APPLICATIONS:

- Pumps
- Mills
- Fans & Blowers
- Grinders
- Compressors

FEATURES:

- Output Range: 100 - 800 HP
- Speed: 3600, 1800, 1200, 900 RPM
- Enclosure: Totally Enclosed Fan Cooled (IP55)
- Voltage: 2300/4160V
- Three Phase, 60 Hz, 1.15 Service Factor (Continuous)
- CSA Certified for Class I, Div. 2, for 5000 Frames and above, at 1.15 Service Factor is temperature coded: T3 (125 to 400 HP); T2D (401 to 800 HP); T2B (801 to 900 HP); and at 1.0 Service Factor is T3 only.
- CSA Certified for Class 1, Div. 2, Groups B, C, and D, for 444 Frames and above, Code T3⁵
- Standard Features: 100 Ohm Platinum Stator RTD's (2/Phase), Space Heaters (120V)
- Class F Insulation
- Class B Temperature Rise
- NEMA Design B Torques
- Oversized Main Conduit Box Rotatable in 90 Degree Increments
- Fully Gasketed with NPT Threaded Entrance - F1 Mounted
- Cast Iron Terminal Box on 444T - 449T Frames
- Steel Plate Terminal Box on 5000 Frames and Above
- Designed for 40°C Ambient Temperature¹
- Designed for 3300 ft. Elevation²
- Bi-Directional Rotation for all 444T - 449T Frames and for 1800 - 900RPM (4 - 8 Pole) 5007 - 6808 Frame Motors and for (4-8 Pole) 5007-6808 Frame Motors
- 5007 - 6808 Frame 3600RPM (2 Pole) Motors have Counter-Clockwise (CCW) Rotation facing the Drive End
- Cast Iron Frame and End Brackets
- 1045 Carbon Steel Shaft
- Aluminum Die Cast Squirrel Cage Rotor Construction on 444T - 449T Frames
- Squirrel Cage Copper or Copper Alloy Bar Rotor Construction for on 5007 - 6808 Frames
- Paint System: Phenolic Rust Proof Base Plus Polyurethane Top Coat
- Paint Color: Dark Gray - Munsell 7.5B 3.5/0.5
- High Quality Ball (or Roller) Bearings Regreasable with Mobil Polyrex™ EM
- Metal Flinger on Both Ends
- Cast Iron Inner and Outer Bearing Caps
- Grounding Terminal Inside Main Box and on Motor Foot
- Stainless Steel Nameplate
- 6 Leads, with Solderless Lug Terminals
- Motors are CSA Approved
- Suitable for Inverter Use per NEMA MG-1 Part 31.4.4.2^(4,5)
- Inverter Duty Speed Range: 20:1 Variable Torque, 10:1 Constant Torque (350 HP and Larger are 3:1 Constant Torque)
- 2-Pole motors, 600HP and larger, are Form Wound and Insulated Non-Drive End Bearing
- Spotface ¼ -28UNF Tap x 12mm Deep on Top of Both End Brackets with VB300 Vibration Sensor on 5000 Frames and Larger

EXTRAS/ OPTIONS:

Please refer to pages 147 - 152 for common modifications that can be performed.

Notes:

1. Consult a Stock Product Application Specialist for suitability in higher ambient environments, and for variable and constant torque speed ranges.
2. Consult a Stock Product Application Specialist for suitability at higher elevations.
3. Motor service factor is 1.0 when operated on a VFD.
4. Precautions should be taken to eliminate or reduce shaft currents that may be imposed on the motor by the VFD as stated per NEMA MG-1, Part 31. An isolation transformer or other method of mitigating common mode voltages from motor terminals must be utilized. Please refer to page 211 to check out our accompanying TeamMaster™ starters.
5. Consult Stock Product Specialist for various temp codes on which ratings.



CATALOG NUMBER	HP	RPM	FRAME	FL EFF %	FL PF %	FL AMPS (460V)	APPROX. SHIPPING WT. (lbs.)	LIST PRICE (\$)
KG1002	100	3600	444TS	91.7	86.0	23.7	1,470	31,101
KG1004	100	1800	444T	93.0	79.5	25.3	2,079	32,304
KG1006	100	1200	444/5T	94.1	81.0	24.6	2,903	35,741
KG1006R	100	1200	444/5T	94.1	81.0	24.6	2,903	35,741
KG1008	100	900	444/7T	94.1	74.8	26.6	2,363	46,392
KG1008R	100	900	444/7T	94.1	74.8	26.6	2,363	46,392
KG1252	125	3600	444/5TS	92.9	88.0	28.6	1,838	38,857
KG1254	125	1800	444/5T	93.6	78.0	32.0	1,990	38,793
KG1256	125	1200	444/7T	94.7	80.0	30.9	2,415	49,665
KG1256R	125	1200	444/7T	94.7	80.0	30.9	2,415	49,665
KG1258	125	900	447/9T	94.7	77.0	32.1	2,835	60,443
KG1258R	125	900	447/9T	94.7	77.0	32.1	2,835	60,443
KG1502	150	3600	444/7TS	93.2	90.0	33.5	2,600	43,806
KG1504	150	1800	444/7T	94.1	80.7	37.0	2,375	43,256
KG1506	150	1200	447/9T	94.8	80.0	37.0	2,903	50,507
KG1506R	150	1200	447/9T	94.8	80.0	37.0	2,903	50,507
KG2002	200	3600	447/9TS	95.0	88.0	44.8	2,495	46,914
KG2004	200	1800	447/9T	95.7	81.4	48.0	2,775	50,423
KG2006T	200	1200	447/9T	96.0	81.0	48.2	2,930	67,615
KG2502T	250	3600	447/9TS	95.9	88.0	55.5	2,480	58,401
KG2504T	250	1800	447/9T	95.7	82.2	59.5	2,640	61,239
KG3002T	300	3600	447/9TS	96.0	87.0	67.3	2,950	74,816
KG3004T	300	1800	447/9T	95.8	84.0	69.8	3,150	68,548
KG3506	350	1200	5010/11B	95.0	86.3	79.9	4,988	100,502
KG3508	350	900	5808B	95.0	81.0	85.1	5,355	127,988
KG4008	400	900	5808B	95.0	81.0	97.0	5,565	146,516
KG4506	450	1200	5808B	95.4	86.5	102	5,565	126,475
KG5002	500	3600	5808A	95.4	91.0	108	5,250	126,418
KG5004	500	1800	5808B	95.8	90.5	108	5,250	121,835
KG5006	500	1200	5810B	95.4	87.0	113	6,495	144,300
KG5008	500	900	6808B	95.4	85.0	115	7,245	190,980
KG6002 ¹	600	3600	5810A	95.8	91.0	129	6,248	138,189
KG6004	600	1800	5810B	95.8	90.5	130	7,010	146,616
KG6008	600	900	6808B	95.4	85.0	139	7,770	203,027
KG7006	700	1200	6808B	95.8	87.2	157	7,403	186,530
KG7008	700	900	6808B	95.4	86.0	160	9,083	204,466
KG8002 ¹	800	3600	6808A	96.2	91.5	170	8,768	199,821
KG8004	800	1800	6808B	95.8	90.5	173	9,275	182,608

Notes:

1. Insulated non-drive end bearing as standard on 2 pole motors 400 HP and larger. Motors are unidirectional, with counter clockwise rotation, facing the drive end, to change please consult factory.
2. Data subject to change without notice.

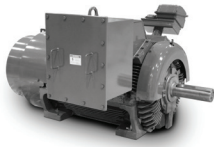

APPLICATIONS:

- | | | |
|---------|------------------|---------------|
| ■ Pumps | ■ Fans & Blowers | ■ Compressors |
| ■ Mills | ■ Grinders | |

FEATURES:

- Speed: 3600, 1800, 1200, 900 RPM
- Enclosure: Totally Enclosed Fan Cooled (IP55)
- Voltage: 2300/4000V
- Three Phase, 60 Hz, 1.15 Service Factor (Continuous)
- CSA Certified for Class I, Div. 2, Group B, C, D - Temp Code T3 Minimum
- CSA Certified for Class II, Div. 2, Group F & G - T3C Minimum
- Standard Features: 100 Ohm Platinum Stator RTD's(2/Phase), Space Heaters(120V), and Provisions for Bearing RTD's.
- Class F Insulation
- Class B Temperature Rise
- NEMA Design B Torques
- Oversized Fabricated Steel Main Conduit Box Rotatable in 90 Degree Increments Fully Gasketed with NPT Threaded Entrance - F1 Mounted
- Designed for 40°C Ambient Temperature¹
- Designed for 3300 ft. Elevation²
- Bi-Directional Rotation; except 2 Pole which is Counter-Clockwise (CCW) facing the Drive End
- Cast Iron Frame and End Brackets
- 1045 Carbon Steel Shaft
- Squirrel Cage Copper Bar Rotor Construction
- Paint System: Phenolic Rust Proof Base Plus Polyurethane Top Coat
- Paint Color: Dark Gray - Munsell 7.5B 3.5/0.5
- High Quality Ball (or Roller) Bearings Regreasable with Mobil Polyrex™ EM
- Bronze Type Metal Flinger on Both Ends
- Cast Iron Inner and Outer Bearing Caps
- Grounding Terminal Inside Main Box and on Motor Foot
- Stainless Steel Nameplate
- 6 Leads, with Solderless Lug Terminals
- Motors are CSA Approved
- Suitable for Inverter Use per NEMA MG-1 Part 31.4.4.2^(3,4)
- Inverter Duty Speed Range: 20:1 Variable Torque, 10:1 Constant Torque (350 HP and Larger are 3:1 Constant Torque)
- Spotface ¼ -28UNF Tap x 12mm Deep on Top of Both End Brackets with VB300 Vibration Sensor on 5000 Frames and Larger

EXTRAS/ OPTIONS:

Please refer to pages 147 - 152 for common modifications that can be performed.

Notes:

1. Consult a Stock Product Application Specialist for suitability in higher ambient environments, and for variable and constant torque speed ranges.
2. Consult a Stock Product Application Specialist for suitability at higher elevations.
3. Motor service factor is 1.0 when operated on a VFD.
4. Precautions should be taken to eliminate or reduce shaft currents that may be imposed on the motor by the VFD as stated per NEMA MG-1.Part 31. An isolation transformer or other method of mitigating common mode voltages from motor terminals must be utilized. Please refer to page 184 to check out our accompanying TeamMaster® starters.

GLOBAL MAX



AFHGTK, NEMA, PREMIUM EFFICIENCY, MEDIUM VOLTAGE [KF]

Effective: 01-01-2022
Supersedes: 07-06-2021

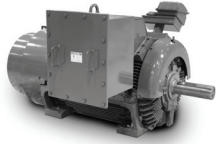

CATALOG NUMBER	HP	RPM	FRAME	FL EFF %	FL PF %	FL AMPS (2300V)	APPROX. SHIPPING WT. (lbs.)	LIST PRICE (\$)
KF5008	500	900	5810B	94.6	77.9	128	9,802	153,954
KF9006	900	1200	6810B	95.5	82.7	213	13,606	175,552
KF9008	900	900	6810B	95.2	73.0	242	13,666	194,982
KF10004	1000	1800	6808B	95.6	80.4	245	11,471	169,080
KF12504	1250	1800	6810B	96.0	81.2	300	13,200	190,451
KF12506	1250	1200	6811B	95.9	84.1	290	17,297	199,630
KF15004	1500	1800	6810B	96.1	82.1	356	15,362	200,666

Notes:

1. Insulated non-drive end bearing as standard.
2. Motors are unidirectional, with counter clockwise rotation, facing the drive end, to change please consult factory.
3. Data subject to change without notice.

GLOBAL MAX



AFJHTK, IEC, HIGH EFFICIENCY, MEDIUM VOLTAGE [JF]

Effective: 01-01-2022
Supersedes: 07-06-2021



CAT. NO.	HP	RPM	FRAME	FL EFF (%)	FL PF (%)	FL AMPS (2300V)	APPROX. SHIPPING WT. (lbs.)	LIST PRICE (\$)
JF09002 ¹	900	3600	400C	95.9	89.6	189	8,200	247,883
JF10002 ²	1000	3600	450C	97.0	91.0	213	9,200	297,459
JF12502	1250	3600	500C ³	96.8	91.5	264	11,500	334,642
JF15002	1500	3600	560C ³	96.3	92.0	318	12,900	388,679
JF17502	1750	3600	560C ³	96.5	92.0	369	13,200	413,344

Notes:

1. 400 frame motor is standard with antifriction ball bearings.
2. 450 frame motor is standard with sleeve bearings and non-drive end insulated bearings; self lubricated.
3. 500 frame and above, standard with sleeve bearings and non-drive end insulated bearings; force feed lubricated.
4. All 3600 RPM motors are Uni-Directional (CCW when facing Drive End)
5. Data subject to change without notice.

MV MAX-E2™ / 841 LITE



AFHP, TEFC, NEMA PREMIUM EFFICIENCY, MEDIUM VOLTAGE (200 HP - 2000 HP) [KPF]

Effective: 01-01-2022
Supersedes: 07-06-2021



APPLICATIONS:

- Fans & Blowers
- Compressors
- Severe Duty/Petro-Chem
- Pumps
- Mixers
- Pulp & Paper Application
- Crushers
- Conveyors

FEATURES:

- Output Range: 200 - 2000 HP
- Speed: 3600, 1800, 1200 & 900 RPM
- Enclosure: Totally Enclosed Fan Cooled (IP55)
- Voltage: 2300/4000V
- Three Phase, 60 Hz, 1.15 Service Factor (Continuous)
- CSA Certified for Class I, Div. 2, Group A, B, C, D - Temp Code T2B Minimum
- CSA Certified for Class II, Div. 2, Group F & G - T3C Minimum
- Standard Features: Provisions for Bearing RTD's, 100 Ohm Platinum Stator RTD's(2/Phase), Space Heaters(120V)
- Class F Insulation
- Class B Temperature Rise
- NEMA Design B Torques
- Oversized Fabricated Steel Main Conduit Box Rotatable in 90 Degree Increments Fully Gasketed with NPT Threaded Entrance - F1 Mounted, Field Convertible to F2 and F3
- Designed for 40°C Ambient Temperature¹
- Designed for 3300 ft. Elevation²
- Bi-Directional Rotation; except 2 Pole which is Counter-Clockwise (CCW) facing the Drive End
- Cast Iron Frame and End Brackets
- 1045 Carbon Steel Shaft
- Aluminum Die Cast Squirrel Cage Rotor Construction or Copper Bar Rotor Construction
- Paint System: 2 Part Epoxy
- Paint Color: Dark Gray - Munsell 7.5B 3.5/0.5
- IEEE 841 Ready
- Grounding Terminal Inside Main Conduit Box with additional Foot Grounding Provision
- Test Report with Vibration Data Shipped with motor
- High Quality Ball (or Roller) Bearings Regreasable with Mobil Polyrex™ EM
- Bronze Metal Flinger on Both Ends
- Cast Iron Inner and Outer Bearing Caps
- Grounding Terminal Inside Main Box and on Motor Foot
- Stainless Steel Nameplate and Hardware
- Stainless Steel Breather Drain
- Vibration Not to Exceed 0.08 Inches Per Second
- Noise Level Not to Exceed 85 dB(A) at 1 Meter Unloaded
- 6 Leads, with Solderless Lug Terminals
- Motors are CSA Approved
- Suitable for Inverter Use per NEMA MG-1 Part 31.4.4.2^(3,4)
- Inverter Duty Speed Range: 10:1 Variable Torque, 3:1 Constant Torque
- Spotface ¼ -28UNF Tap x 12mm Deep on Top of Both End Brackets with VB300 Vibration Sensor on 5000 Frames and Larger

EXTRAS/ OPTIONS:

Please refer to pages 147 - 152 for common modifications that can be performed.

Notes:

1. Consult a Stock Product Application Specialist for suitability in higher ambient environments, and for variable and constant torque speed ranges.
2. Consult a Stock Product Application Specialist for suitability at higher elevations.
3. Motor service factor is 1.0 when operated on a VFD.
4. Precautions should be taken to eliminate or reduce shaft currents that may be imposed on the motor by the VFD as stated per NEMA MG-1.Part 31. An isolation transformer or other method of mitigating common mode voltages from motor terminals must be utilized. Please refer to page XXX to check out our accompanying TeamMaster TM starters.

MV MAX-E2™ / 841 LITE



AFHP, TEFC, NEMA PREMIUM EFFICIENCY, MEDIUM VOLTAGE [KPF]
200 HP - 2000 HP

Effective: 01-01-2022
Supersedes: 07-06-2021



CATALOG NUMBER	HP	RPM	FRAME	FL EFF %	FL PF %	FL AMPS (4000V)	APPROX. SHIPPING WT. (lbs.)	LIST PRICE (\$)
KPF2006	200	1200	5007/9B	95.2	74.6	29.0	3,350	64,118
KPF2006R	200	1200	5007/9C	95.2	74.6	29.0	3,350	64,118
KPF2008	200	900	5007/9B	93.9	74.8	29.0	3,610	76,116
KPF2008R	200	900	5007/9C	93.9	74.8	29.0	3,610	76,116
KPF2502	250	3600	5007/9A	95.0	84.0	32.0	3,220	60,771
KPF2504	250	1800	5007/9B	95.0	85.6	32.0	3,450	63,323
KPF2504R	250	1800	5007/9C	95.0	85.6	32.0	3,450	63,323
KPF2506	250	1200	5007/9B	95.3	76.0	36.0	3,560	71,787
KPF2506R	250	1200	5007/9C	95.3	76.0	36.0	3,560	71,787
KPF2508	250	900	5007/9B	94.1	75.8	36.0	3,920	98,375
KPF2508R	250	900	5007/9C	94.1	75.8	36.0	3,920	98,375
KPF3002	300	3600	5007/9A	95.0	85.9	38.0	3,440	73,758
KPF3004	300	1800	5007/9B	95.0	86.1	38.0	3,580	70,829
KPF3004R	300	1800	5007/9C	95.0	86.1	38.0	3,580	70,829
KPF3006	300	1200	5007/9B	95.4	77.6	42.0	3,790	80,144
KPF3006R	300	1200	5007/9C	95.4	77.6	42.0	3,790	80,144
KPF3008	300	900	5009/10/11B	94.2	75.3	44.0	4,630	111,067
KPF3008R	300	900	5009/10/11C	94.2	75.3	44.0	4,630	111,067
KPF3502	350	3600	5007/9A	95.0	88.1	43.0	3,660	84,138
KPF3504	350	1800	5007/9B	95.0	84.1	45.0	3,700	87,398
KPF3504R	350	1800	5007/9C	95.0	84.1	45.0	3,700	87,398
KPF3506	350	1200	5007/9B	95.5	79.6	48.0	4,010	84,138
KPF3506R	350	1200	5007/9C	95.5	79.6	48.0	4,010	84,138
KPF3508	350	900	5009/10/11B	94.4	76.3	50.0	5,040	119,483
KPF3508R	350	900	5009/10/11C	94.4	76.3	50.0	5,040	119,483
KPF4002	400	3600	5009/10/11A	95.0	88.5	49.0	4,150	92,234
KPF4004	400	1800	5009/10/11B	95.0	85.7	51.0	3,840	91,480
KPF4004R	400	1800	5009/10/11C	95.0	85.7	51.0	3,840	91,480
KPF4006	400	1200	5009/10/11B	95.6	78.0	56.0	4,540	97,327
KPF4006R	400	1200	5009/10/11C	95.6	78.0	56.0	4,540	97,327
KPF4008	400	900	5009/10/11B	94.5	80.6	54.0	5,170	126,004
KPF4008R	400	900	5009/10/11C	94.5	80.6	54.0	5,170	126,004
KPF4502	450	3600	5009/10/11A	95.0	88.6	55.0	4,390	101,816
KPF4504	450	1800	5009/10/11B	95.0	86.9	56.0	4,210	99,366
KPF4504R	450	1800	5009/10/11C	95.0	86.9	56.0	4,210	99,366
KPF4506	450	1200	5009/10/11B	95.9	79.2	61.0	4,820	108,769
KPF4506R	450	1200	5009/10/11C	95.9	79.2	61.0	4,820	108,769

Notes:

1. Insulated non-drive end bearing as standard. Motors are unidirectional, with counter clockwise rotation, facing the drive end, to change please consult factory.
2. Data subject to change without notice.

MV MAX-E2™ / 841 LITE



**AFHP, TEFC, NEMA PREMIUM EFFICIENCY, MEDIUM VOLTAGE [KPF]
200 HP - 2000 HP**

Effective: 01-01-2022
Supersedes: 07-06-2021



CATALOG NUMBER	HP	RPM	FRAME	FL EFF %	FL PF %	FL AMPS (4000V)	APPROX. SHIPPING WT. (lbs.)	LIST PRICE (\$)
KPF4508	450	900	5810B	94.6	74.9	66.0	6,200	146,084
KPF4508R	450	900	5810C	94.6	74.9	66.0	6,200	146,084
KPF5002	500	3600	5009/10/11A	95.0	89.5	61.0	4,540	108,719
KPF5004	500	1800	5009/10/11B	95.0	87.0	63.0	4,380	104,778
KPF5004R	500	1800	5009/10/11C	95.0	87.0	63.0	4,380	104,778
KPF5006	500	1200	5009/10/11B	96.0	80.7	67.0	5,030	115,556
KPF5006R	500	1200	5009/10/11C	96.0	80.7	67.0	5,030	115,556
KPF5008	500	900	5810B	94.6	75.8	72.0	6,400	158,225
KPF5008R	500	900	5810C	94.6	75.8	72.0	6,400	158,225
KPF6002	600	3600	5009/10/11A	95.4	87.1	75.0	4,770	118,841
KPF6004	600	1800	5009/10/11B	95.4	87.3	75.0	4,690	112,896
KPF6004R	600	1800	5009/10/11C	95.4	87.3	75.0	4,690	112,896
KPF6006	600	1200	5810B	95.3	81.2	80.0	6,400	152,571
KPF6006R	600	1200	5810C	95.3	81.2	80.0	6,400	152,571
KPF6008	600	900	5810B	94.6	76.1	86.0	6,800	167,384
KPF6008R	600	900	5810C	94.6	76.1	86.0	6,800	167,384
KPF7002	700	3600	5810A	95.4	87.7	87.0	6,100	146,265
KPF7004	700	1800	5810B	95.4	84.9	90.0	6,500	145,580
KPF7004R	700	1800	5810C	95.4	84.9	90.0	6,500	145,580
KPF7006	700	1200	5810B	95.4	82.4	92.0	6,800	160,416
KPF7006R	700	1200	5810C	95.4	82.4	92.0	6,800	160,416
KPF7008	700	900	5810B	94.8	75.0	102	7,400	175,840
KPF7008R	700	900	5810C	94.8	75.0	102	7,400	175,840
KPF8002	800	3600	5810A	95.6	88.1	98.0	6,400	153,862
KPF8004	800	1800	5810B	95.6	84.8	102	6,800	160,653
KPF8004R	800	1800	5810C	95.6	84.8	102	6,800	160,653
KPF8006	800	1200	6808B	95.5	81.9	106	8,600	191,163
KPF8006R	800	1200	6808C	95.5	81.9	106	8,600	191,163
KPF8008	800	900	6808B	95.0	74.5	117	9,400	190,563
KPF8008R	800	900	6808C	95.0	74.5	117	9,400	190,563
KPF9002	900	3600	5810A	95.6	87.4	112	6,500	164,226
KPF9004	900	1800	5810B	95.6	85.0	115	6,800	175,293
KPF9004R	900	1800	5810C	95.6	85.0	115	6,800	175,293
KPF9006	900	1200	6808B	95.7	81.4	120	9,000	211,004
KPF9006R	900	1200	6808C	95.7	81.4	120	9,000	211,004
KPF9008	900	900	6808B	95.2	74.2	132	9,900	220,628
KPF9008R	900	900	6808C	95.2	74.2	132	9,900	220,628

Notes:

1. Insulated non-drive end bearing as standard. Motors are unidirectional, with counter clockwise rotation, facing the drive end, to change please consult factory.
2. Data subject to change without notice.

MV MAX-E2™ / 841 LITE



AFHP, TEFC, NEMA PREMIUM EFFICIENCY, MEDIUM VOLTAGE [KPF]
200 HP - 2000 HP

Effective: 01-01-2022
Supersedes: 07-06-2021



CATALOG NUMBER	HP	RPM	FRAME	FL EFF %	FL PF %	FL AMPS (4000V)	APPROX. SHIPPING WT. (lbs.)	LIST PRICE (\$)
KPF10004	1000	1800	5810B	95.6	84.7	128	7,000	189,503
KPF10004R	1000	1800	5810C	95.6	84.7	128	7,000	189,503
KPF10006	1000	1200	6810/11/12B	95.8	81.8	132	10,500	239,047
KPF10006R	1000	1200	6810/11/12C	95.8	81.8	132	10,500	239,047
KPF10008	1000	900	6810/11/12B	95.4	74.2	146	11,600	256,697
KPF10008R	1000	900	6810/11/12C	95.4	74.2	146	11,600	256,697
KPF12504	1250	1800	6808B	96.0	83.0	162	9,300	223,421
KPF12504R	1250	1800	6808C	96.0	83.0	162	9,300	~
KPF12506	1250	1200	6810/11/12B	96.0	81.2	166	11,600	268,594
KPF12506R	1250	1200	6810/11/12C	96.0	81.2	166	11,600	268,594
KPF12508	1250	900	6810/11/12B	95.6	76.4	177	13,000	286,816
KPF12508R	1250	900	6810/11/12C	95.6	76.4	177	13,000	286,816
KPF15004	1500	1800	6810/11/12B	96.1	84.1	192	11,700	251,007
KPF15004R	1500	1800	6810/11/12C	96.1	84.1	192	11,700	251,007
KPF15006	1500	1200	6810/11/12B	96.3	82.1	196	12,900	298,917
KPF15006R	1500	1200	6810/11/12C	96.3	82.1	196	12,900	298,917
KPF15008	1500	900	6810/11/12B	95.8	75.1	216	14,100	322,636
KPF15008R	1500	900	6810/11/12C	95.8	75.1	216	14,100	~
KPF17504	1750	1800	6810/11/12B	96.3	83.8	225	12,600	272,512
KPF17504R	1750	1800	6810/11/12C	96.3	83.8	225	12,600	272,512
KPF17506	1750	1200	6810/11/12B	96.5	82.8	227	13,800	326,409
KPF17506R	1750	1200	6810/11/12C	96.5	82.8	227	13,800	326,409
KPF20004	2000	1800	6810/11/12B	96.5	83.1	258	13,400	297,394
KPF20004R	2000	1800	6810/11/12C	96.5	83.1	258	13,400	297,394

Notes:

1. Insulated non-drive end bearing as standard. Motors are unidirectional, with counter clockwise rotation, facing the drive end, to change please consult factory.
2. Data subject to change without notice.

VERTICAL HOLLOW SHAFT WPI HIGH THRUST with "P" BASE - LOW VOLTAGE



CCO02A



AMRCNH, (MAX-VHP™) NEMA PREMIUM (7/5 HP - 800 HP) [VHP & VHP_FP]*
AMRCFP, (MAX-VH™) HIGH EFFICIENCY (7/5 HP - 400 HP) [VH_FP], FIRE PUMP

Effective: 01-01-2022
 Supersedes: 07-06-2021



FIRE SAFETY

APPLICATIONS:

- Deep Well Turbine Pumps
- Irrigation
- Fire Pumps
- Fluid Handling Systems
- Water/ Waste Water

FEATURES:

- Output Range: 7.5 - 800 HP
- Speed: 1800 RPM
- Enclosure: Weather Protected Type I (WPI)
- Voltage: 230/460V (Usable on 208V); 150HP and Larger is 460V Only
- Three Phase, 60 Hz, 1.15 Service Factor (Continuous on Sine Wave Power)
- Inverter Duty (PWM) per NEMA® MG-1 Part 31 at 1.0 Service Factor
- Dual Column (60/50 Hz) Design Nameplate as Standard; 50 Hz Data 190/380V at 1.0 S.F.
- Standard Features: Coupling w/ Gib Key, Ball Type NRR, Drip/Splash Cover, Space Heaters (120V)
- 5000 Frames and Above also include Mounting Provisions for bearing RTD's and Insulated Bearing Housing
- Optional Capability for 175% High Thrust Requirement for 444 - 449TP Frames
- Motor Design Suitable to handle 2 stacked bearings; Motors will ship with 1 bearing and 1 spacer as Standard*
- Class F Insulation with Phenolic Alkyd Resin Varnish
- Class B Temperature Rise
- NEMA Design B Torques
- Oversized Main Conduit Box Rotatable in 90 Degree Increments - Fully Gasketed with NPT Threaded Entrance
- Cast Iron Conduit Box for F#449TP and Below; Steel Plate Conduit Box for F#5000
- Designed for 40°C Ambient Temperature¹
- Designed for 3300 ft. Elevation²
- Counterclockwise (CCW) Rotation; Viewed from Top
- Cast Iron Frame & End Brackets
- 1045 Hollow Carbon Steel Shaft
- Aluminum Die Cast Squirrel Cage Rotor Construction for F#449TP and Below
- Squirrel Cage Copper or Copper Alloy Bar Rotor Construction for F#5000
- Paint System: Phenolic Rust Proof Base Plus Polyurethane Top Coat
- Paint Color for AMRC (MAX-VH™): Dark Gray - Munsell 7.5B 3.5/0.5
- Paint Color for AMRCNH (MAX-VHP™): Blue - Munsell 5PB 3/8
- Guide Bearings: 213 - 286TP frames are Grease Pre-packed Double Shielded Bearings (MULTEMP SRL)
324TP - 5009P frames are Re-Greasable (Mobil Polyrex EM)
- Thrust Bearings: 213 - 286TP frames are Re-Greasable Angular Contact (Mobil Polyrex EM);
324 - 449TP frames are Oil Lubricated Angular Contact; F#5000 and Above with Spherical Roller
- Oil Sight Glass for 324TP Frames and Above
- Oil Requirements: 300 S.S.U. @100°F
- Grounding Terminal Inside Main Box
- Stainless Steel Nameplate and Rodent Screens
- 12 Leads (PWS on 230V), Wye/Delta on 230/460V for 210TP-400TP
- 6 Leads (PWS on 230V, Wye D on 460V for 444TP-5810P)
- Suitable for Inverter Use per NEMA MG-1 Part 31.4.4.2
- 10:1 Variable Torque with NRR. 10:1 C.T., 20:1 VT without NRR Using Braking in VFD
- Precautions should be taken to eliminate or reduce shaft currents that may be imposed on the motor by VFD at stated per NEMA MG-1, part 31 for AMRCNH and Part 30 for AMRC.

EXTRAS/ OPTIONS:

Please refer to pages 147 - 152 which show common modifications that can be performed.

Notes:

- * Fire Pump available. See product page for more details.
- 1. Consult a Stock Product Application Specialist for suitability in higher ambient environments.
- 2. Consult a Stock Product Application Specialist for suitability at higher elevations.
- 3. Suitable for Wye/Delta start at 230V or 460V.

MAX-VHP™ VERTICAL HOLLOW SHAFT WPI



AMRCNH, (MAX-VHP™) NEMA PREMIUM [VHP]*

Effective: 01-01-2022
Supersedes: 07-06-2021



CATALOG NUMBER	HP	RPM	FRAME	FL EFF %	FL PF %	FL AMPS (460V)	DOWN THRUST (lbs.)	BD DIM. (in.)"	CD DIM. (in.)	BX DIM. (in.)	APPROX. SHIPPING WT. (lbs.)	MOTOR LIST PRICE (\$)
VHP7/54	7.5	1800	213TP	91.0	81.0	9.60	2,600	10.0	20.25	1.001	227	4,811
VHP0104	10	1800	215TP	91.7	84.0	12.2	2,600	10.0	20.25	1.001	241	5,224
VHP0154	15	1800	254TP	93.0	83.0	18.2	3,350	10.0	23.38	1.001	349	6,121
VHP0204	20	1800	256TP	93.0	83.0	24.3	3,350	10.0	23.38	1.001	373	6,243
VHP0254	25	1800	284TP	93.6	85.0	29.4	3,350	10.0	24.75	1.001	480	7,650
VHP0304	30	1800	286TP	94.1	86.0	34.7	3,350	10.0	24.75	1.001	525	7,954
VHP0404	40	1800	324TP	94.1	86.0	46.3	5,700	16.5	28.22	1.188	716	11,005
VHP0504	50	1800	326TP	94.5	85.0	58.5	5,700	16.5	28.22	1.188	777	11,616
VHP0604	60	1800	364TP	95.0	85.0	69.5	6,000	16.5	31.16	1.188	892	13,158
VHP0754	75	1800	365TP	95.0	86.0	86.0	6,000	16.5	31.16	1.188	989	13,413
VHP1004	100	1800	404TP	95.4	85.5	115	7,900	16.5	36.94	1.501	1,278	22,645
VHP1254	125	1800	405TP	95.4	84.5	145	7,900	16.5	36.94	1.501	1,398	23,263
VHP1504	150	1800	444TP	95.8	86.0	171	10,700	16.5	44.78	1.501	1,815	45,812
VHP2004	200	1800	445TP	95.8	86.5	225	10,700	16.5	44.78	1.501	1,815	47,265
VHP2504	250	1800	445TP20	95.8	86.5	284	13,400	20.0	44.78	1.501	2,312	54,579
VHP3004	300	1800	447TP	95.8	87.5	337	13,400	20.0	49.78	1.688	2,841	58,850
VHP3504	350	1800	447TP	95.8	88.0	390	13,300	20.0	49.78	1.688	3,335	63,096
VHP4004	400	1800	449TP	95.8	88.5	444	13,200	20.0	53.91	1.938	3,818	67,303
VHP4504	450	1800	5009P	96.2	88.6	494	30,900	24.5	57.06	2.188	3,940	103,432
VHP5004	500	1800	5009P	96.2	88.8	548	30,900	24.5	57.06	2.188	4,070	107,751
VHP6004	600	1800	5808P	96.2	82.0	647	30,100	30.5	61.30	2.376	5,700	124,808
VHP7004	700	1800	5810P	96.2	90.7	751	30,100	30.5	68.78	2.376	6,100	129,088
VHP8004	800	1800	5810P	96.2	90.7	859	30,100	30.5	68.78	2.376	6,400	133,663

Notes:

- * Fire Pump available as made to order. Fire Pump Certificate complies with ANSI/UL 1004-5. Certificate# 20120717 - EX6569.
- 1. Delivery for Fire Pump Duty motor (Catalog Number + FP) is standard 5 - 10 working days after receipt of order if standard motor is in stock; Painting to Fire Safety Red requirement on Fire Pump Duty type motor can be waived in order to expedite delivery upon request.
- 2. Fire Pump Duty Motor pricing includes: adding UL nameplate, restamping original nameplate to new "VHP_FP" catalog number, and Fire Safety Red Paint.
- 3. See page 130 in order to confirm the TWMC standard coupling size is suitable for customer requirements or to select an alternate coupling size. Required coupling size must be noted on all vertical hollow shaft motors orders. Coupling will be changed out prior to shipping if a non-TWMC standard coupling size is needed.
- 4. Data subject to change without notice.

MAX-VHP™ VERTICAL HOLLOW SHAFT WPI



AMRCNH, (MAX-VHP™) NEMA PREMIUM [VHP_FP]*

Effective: 01-01-2022

FIRE PUMP

Supersedes: 07-06-2021



FIRE PUMP CATALOG NUMBER	HP	RPM	FRAME	FL EFF %	FL PF %	FL AMPS (460V)	DOWN THRUST (lbs.)	BD DIM. (in.)"	CD DIM. (in.)	BX DIM. (in.)	APPROX. SHIPPING WT. (lbs.)	FIRE PUMP LIST PRICE (\$)
VHP7/54FP	7.5	1800	213TP	91.0	81.0	9.60	2,600	10.0	20.25	1.001	227	5,052
VHP0104FP	10	1800	215TP	91.7	84.0	12.2	2,600	10.0	20.25	1.001	241	5,486
VHP0154FP	15	1800	254TP	93.0	83.0	18.2	3,350	10.0	23.38	1.001	349	6,427
VHP0204FP	20	1800	256TP	93.0	83.0	24.3	3,350	10.0	23.38	1.001	373	6,557
VHP0254FP	25	1800	284TP	93.6	85.0	29.4	3,350	10.0	24.75	1.001	480	8,032
VHP0304FP	30	1800	286TP	94.1	86.0	34.7	3,350	10.0	24.75	1.001	525	8,352
VHP0404FP	40	1800	324TP	94.1	86.0	46.3	5,700	16.5	28.22	1.188	716	11,556
VHP0504FP	50	1800	326TP	94.5	85.0	58.5	5,700	16.5	28.22	1.188	777	12,198
VHP0604FP	60	1800	364TP	95.0	85.0	69.5	6,000	16.5	31.16	1.188	892	13,817
VHP0754FP	75	1800	365TP	95.0	86.0	86.0	6,000	16.5	31.16	1.188	989	14,083
VHP1004FP	100	1800	404TP	95.4	85.5	115	7,900	16.5	36.94	1.501	1,278	23,777
VHP1254FP	125	1800	405TP	95.4	84.5	145	7,900	16.5	36.94	1.501	1,398	24,426
VHP1504FP	150	1800	444TP	95.8	86.0	171	10,700	16.5	44.78	1.501	1,815	48,102
VHP2004FP	200	1800	445TP	95.8	86.5	225	10,700	16.5	44.78	1.501	1,815	49,628
VHP2504FP	250	1800	445TP20	95.8	86.5	284	13,400	20.0	44.78	1.501	2,312	57,309
VHP3004FP	300	1800	447TP	95.8	87.5	337	13,400	20.0	49.78	1.688	2,841	61,793
VHP3504FP	350	1800	447TP	95.8	88.0	390	13,300	20.0	49.78	1.688	3,335	66,250
VHP4004FP	400	1800	449TP	95.8	88.5	444	13,200	20.0	53.91	1.938	3,818	70,670

Notes:

- * Fire Pump conversion with modifications listed in Note 1 below, Fire Pump Certificate complies with ANSI/UL 1004-5. Certificate# 20120717 - EX6569.
- 1. Delivery for Fire Pump Duty motor (Catalog Number + FP) is standard 5 - 10 working days after receipt of order if standard motor is in stock;
- 2. Fire Pump Duty Motor pricing includes: adding UL nameplate, restamping original nameplate to new "VHP_FP" catalog number.
- 3. See page 130 in order to confirm the TWMC standard coupling size is suitable for customer requirements or to select an alternate coupling size. Required coupling size must be noted on all vertical hollow shaft motors orders. Coupling will be changed out prior to shipping if a non-TWMC standard coupling size is needed.
- 4. Data subject to change without notice.

MAX-VH™ VERTICAL HOLLOW SHAFT WPI



AMRCPF, (MAX-VH™) HIGH EFFICIENCY [VH_FP]
FIRE PUMP*

Effective: 01-01-2022
Supersedes: 07-06-2021



FIRE PUMP CATALOG NUMBER	HP	RPM	FRAME	FL EFF %	FL PF %	FL AMPS (460V)	DOWN THRUST (lbs.)	BD DIM. (in.)"	CD DIM. (in.)	BX DIM. (in.)	APPROX. SHIPPING WT. (lbs.)	FIRE PUMP LIST PRICE (\$)
VH7/54FP	7.5	1800	213TP	88.5	85.0	9.35	2,600	10.0	20.25	1.001	227	4,501
VH0104FP	10	1800	215TP	89.5	86.5	12.1	2,600	10.0	20.25	1.001	241	4,988
VH0154FP	15	1800	254TP	91.0	88.0	17.5	3,350	10.0	23.38	1.001	349	5,722
VH0204FP	20	1800	256TP	91.0	88.0	23.4	3,350	10.0	23.38	1.001	373	5,918
VH0254FP	25	1800	284TP	91.7	86.0	29.7	3,350	10.0	24.75	1.001	480	7,153
VH0304FP	30	1800	286TP	92.4	86.5	35.1	3,350	10.0	24.75	1.001	525	7,667
VH0404FP	40	1800	324TP	93.0	88.0	45.7	5,700	16.5	28.22	1.188	716	9,752
VH0504FP	50	1800	326TP	93.0	88.0	57.0	5,700	16.5	28.22	1.188	777	10,822
VH0604FP	60	1800	364TP	93.6	84.5	71.0	6,000	16.5	31.16	1.188	892	11,758
VH0754FP	75	1800	365TP	94.1	84.5	88.5	6,000	16.5	31.16	1.188	989	12,409
VH1004FP	100	1800	404TP	94.1	86.0	116	7,900	16.5	36.94	1.501	1,278	20,878
VH1254FP	125	1800	405TP	94.5	87.5	142	7,900	16.5	36.94	1.501	1,398	21,612
VH1504FP	150	1800	444TP	95.0	86.0	172	10,700	16.5	44.78	1.501	1,815	43,102
VH2004FP	200	1800	445TP	95.0	86.5	228	10,700	16.5	44.78	1.501	1,815	44,034
VH2504FP	250	1800	445TP20	95.4	86.5	284	13,400	20.0	44.78	1.501	2,312	49,633
VH3004FP	300	1800	447TP	95.4	87.5	337	13,400	20.0	49.78	1.688	2,841	53,120
VH3504FP	350	1800	447TP	95.4	88.0	390	13,300	20.0	49.78	1.688	3,335	56,607
VH4004FP	400	1800	449TP	95.4	88.5	444	13,200	20.0	53.91	1.938	3,818	58,497

Notes:

- * Fire Pump Certificate complies with ANSI/UL 1004-5. Certificate# 20120717 - EX6569.
- 1. Fire Pump Duty Motor pricing includes: UL nameplate.
- 2. See page 130 in order to confirm the TWMC standard coupling size is suitable for customer requirements or to select an alternate coupling size. Required coupling size must be noted on all vertical hollow shaft motors orders. Coupling will be changed out prior to shipping if a non-TWMC standard coupling size is needed.
- 3. Data subject to change without notice.

VERTICAL HOLLOW SHAFT TEFC HIGH THRUST with "P" BASE - LOW VOLTAGE

NEMA
Premium

ee

CCO02A

SF

UL

CE

AEEHNNH, (MAX-VHP™) NEMA PREMIUM (15 HP - 800 HP) [VHTP]

Effective: 01-01-2022
Supersedes: 07-06-2021

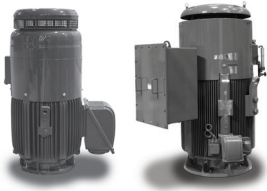

APPLICATIONS:

- Deep Well Turbine Pumps
- Irrigation
- Water/Wastewater

FEATURES:

- Output Range: 15 - 800 HP
- Speed: 1800 & 1200 RPM
- Enclosure: Totally Enclosed Fan Cooled (IP55)
- Voltage: 230/460V (Usable on 208V); 150HP and Larger is 460V Only
- 230/460V Motors Suitable for Partial Winding Start (at 230V Only)
- Three Phase, 60 Hz, 1.15 Service Factor (Continuous on Sine Wave Power)
- CSA Certified for Class I, Div. 2, Group B, C, D - Temp Code T3 Minimum
- Inverter Duty (PWM) per NEMA® MG-1 Part 31 at 1.0 Service Factor
- Dual Column (60/50 Hz) Design Nameplate as Standard; 50 Hz Data 190/380V at 1.0 S.F.
- Standard Features: Coupling w/ Gib Key, Non-Sparking Ball Type NRR, Drip/Splash Cover, Space Heaters (120V)
- 5000 Frames and Above also include Mounting Provisions for bearing RTD's and Insulated Bearing Housing
- CSA Certified for Class I, Div. 2, Groups B,C, D; Temp Code T3 minimum
- Class F Insulation with Phenolic Alkyd Resin Varnish
- Class B Temperature Rise
- NEMA Design B Torques
- Oversized Main Conduit Box Rotatable in 90 Degree Increments - Fully Gasketed with NPT Threaded Entrance
- Cast Iron Conduit Box for F#449TP and Below; Steel Plate Conduit Box for F#5000
- Designed for 40°C Ambient Temperature¹
- Designed for 3300 ft. Elevation²
- Counterclockwise (CCW) Rotation; Viewed from Top
- Cast Iron Frame & End Brackets
- 1045 Hollow Carbon Steel Shaft
- Aluminum Die Cast Squirrel Cage Rotor Construction
- Paint System: Phenolic Rust Proof Base Plus Polyurethane Top Coat
- Paint Color: Blue - Munsell 5PB 3/8
- Guide Bearings: 254 - 286TP frames are Grease Pre-packed Double Shielded Bearings (MULTEMP SRL)
324TP - 5810P frames are Re-Greasable (Mobil Polyrex EM)
- Thrust Bearings: 254 - 365TP frames are Re-Greasable Angular Contact (Mobil Polyrex EM);
404 - 449TP frames are Oil Lubricated Angular Contact; F#5000 & Above with Spherical Roller or Angular Contact
- Oil Requirements: 300 S.S.U. @ 100°F
- Grounding Terminal Inside Main Box
- Stainless Steel Nameplate
- 12 Leads (PWS on 230V) on 213 - 405TP; ⁽³⁾ Suitable for Wye/Delta Start at 230V or 460V.
6 Leads on 444TP to 449TP; 5000 Frames and Above with Connection Studs ⁽⁴⁾
- Suitable for Inverter Use per NEMA MG-1 Part 31.4.4.2
- 4:1 Variable Torque with NRR; 20:1 Variable Torque without NRR Using Braking in VFD
- Precautions should be taken to eliminate or reduce shaft currents that may be imposed on the motor by VFD as stated per NEMA MG-1 Part 31.

EXTRAS/ OPTIONS:

Please refer to pages 147 - 152 for common modifications that can be performed.

Notes:

1. Consult a Stock Product Application Specialist for suitability in higher ambient environments.
2. Consult a Stock Product Application Specialist for suitability at higher elevations.
3. Suitable for Wye/Delta start at 230V or 460V.
4. Suitable for Wye/Delta start at 460V.

MAX-VHP™ VERTICAL HOLLOW SHAFT TEFC



AEENH, (MAX-VHP™) NEMA PREMIUM [VHTP]

Effective: 01-01-2022
Supercedes: 07-06-2021

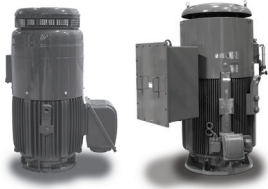

CATALOG NUMBER	HP	RPM	FRAME	FL EFF %	FL PF %	FL AMPS (460V)	DOWN THRUST (lbs.)	BD DIM (in.)	CD DIM (in.)	BX DIM (in.)	APPROX. SHIPPING WT. (lbs.)	LIST PRICE (\$)
VHTP0154	15	1800	254TP	92.4	88.0	17.3	3,350	10.0	22.36	1.001	350	11,403
VHTP0156	15	1200	284TP	92.4	83.5	16.4	3,850	10.0	24.01	1.001	460	13,027
VHTP0158	15	900	286TP	90.2	78.0	39.9	4,400	10.0	25.50	1.001	516	13,339
VHTP0204	20	1800	256TP	93.0	87.5	23.0	3,350	10.0	24.10	1.001	450	11,864
VHTP0206	20	1200	286TP	91.7	84.0	22.1	3,850	10.0	25.51	1.188	550	13,305
VHTP0208	20	900	324TP	91.0	81.0	50.8	6,000	16.5	27.59	1.188	550	17,094
VHTP0254	25	1800	284TP	93.6	86.0	29.1	3,350	10.0	24.01	1.001	520	13,024
VHTP0256	25	1200	324TP	93.0	83.0	26.9	5,200	16.5	27.60	1.188	725	17,049
VHTP0258	25	900	326TP	91.0	80.0	64.3	6,000	16.5	29.08	1.188	743	17,558
VHTP0304	30	1800	286TP	93.6	87.5	34.3	3,350	10.0	25.51	1.001	558	13,312
VHTP0306	30	1200	326TP	93.0	80.5	32.3	5,200	16.5	29.09	1.188	725	17,519
VHTP0308	30	900	364TP	93.0	78.0	77.4	7,500	16.5	30.26	1.188	915	19,527
VHTP0404	40	1800	324TP	94.1	86.0	46.3	4,500	16.5	27.60	1.188	720	17,061
VHTP0406	40	1200	364TP	94.1	86.5	42.3	6,600	16.5	30.26	1.188	898	19,465
VHTP0408	40	900	365TP	93.0	78.0	103	7,500	16.5	31.24	1.188	1001	20,101
VHTP0504	50	1800	326TP	94.5	87.0	57.0	4,500	16.5	29.09	1.188	780	17,519
VHTP0506	50	1200	365TP	94.1	86.0	53.0	6,600	16.5	31.24	1.188	1,025	20,064
VHTP0508	50	900	404TP	93.0	81.0	124	10,500	16.5	38.87	1.501	1,340	31,064
VHTP0604	60	1800	364TP	95.0	86.5	68.5	6,000	16.5	30.26	1.188	900	19,483
VHTP0606	60	1200	404TP	94.5	87.0	63.0	9,000	16.5	38.87	1.501	1,210	31,026
VHTP0608	60	900	405TP	93.0	81.0	149	10,500	16.5	40.38	1.501	1,499	31,819
VHTP0754	75	1800	365TP	95.4	86.5	85.0	6,000	16.5	31.24	1.188	970	20,055
VHTP0756	75	1200	405TP	94.5	86.5	78.5	9,000	16.5	40.39	1.501	1,340	31,761
VHTP1004	100	1800	405TP	95.4	87.5	112	7,900	16.5	40.39	1.501	1,415	31,726
VHTP1006	100	1200	444TP	95.0	79.8	123	10,100	16.5	43.03	1.501	1,990	49,229
VHTP1254	125	1800	444TP	95.4	85.6	143	8,900	16.5	43.03	1.501	2,020	49,019
VHTP1256	125	1200	445TP	95.0	79.0	155	10,100	16.5	45.00	1.501	2,080	50,816
VHTP1504	150	1800	445TP	95.8	88.0	166	8,900	16.5	45.00	1.501	2,120	50,367
VHTP1506	150	1200	447TP	95.8	77.2	189	11,500	20.0	45.94	1.688	2,540	51,538
VHTP2004	200	1800	447TP	96.2	82.5	235	10,100	20.0	45.94	1.688	2,470	59,319
VHTP2006	200	1200	449TP	95.8	76.6	254	11,500	20.0	53.94	1.938	2,780	59,663
VHTP2504	250	1800	449TP	96.2	83.1	292	10,100	20.0	53.94	1.938	2,820	63,226
VHTP2506	250	1200	449TP	95.8	74.3	328	11,500	20.0	53.94	1.938	2,970	68,386
VHTP3004	300	1800	449TP	96.2	83.1	351	10,100	20.0	53.94	1.938	3,540	67,440
VHTP3006	300	1200	5009P	95.8	84.8	345	12,400	24.5	57.20	2.188	3,800	98,624
VHTP3504	350	1800	5009P	96.2	86.3	394	10,800	24.5	57.20	2.188	4,020	91,208
VHTP3506	350	1200	5808P	95.8	80.6	424	20,400	30.5	62.09	2.376	5,700	133,937
VHTP4004	400	1800	5009P	96.2	86.6	449	10,800	24.5	57.20	2.188	4,200	112,364
VHTP4006	400	1200	5808P	95.8	80.9	482	20,400	30.5	62.09	2.438	5,950	143,725
VHTP4504	450	1800	5808P	96.2	84.0	521	10,100	30.5	62.09	2.438	5,990	136,953
VHTP4506	450	1200	5808P	95.8	80.2	547	20,400	30.5	62.09	2.438	6,150	147,571
VHTP5004	500	1800	5808P	96.2	84.0	578	10,100	30.5	62.09	2.438	6,210	139,923
VHTP5006	500	1200	5808P	95.8	81.2	601	20,400	30.5	62.09	2.438	6,600	155,870
VHTP6004	600	1800	5810P	96.2	84.0	694	10,100	30.5	67.20	2.438	6,680	152,304
VHTP6006	600	1200	5810P	95.8	81.7	717	20,400	30.5	67.20	2.438	7,090	168,950
VHTP7004	700	1800	5810P	96.2	85.0	800	10,100	30.5	67.20	2.438	7,070	160,053
VHTP7006	700	1200	5810P	95.8	81.3	840	20,400	30.5	67.20	2.438	8,670	177,451
VHTP8004	800	1800	5810P	96.2	86.0	904	10,100	30.5	67.20	2.438	9,220	181,066

Notes:

- See page 131 in order to confirm the TWMC standard coupling size is suitable for customer requirements or to select an alternate coupling size. Required coupling size must be noted on all vertical hollow shaft motor orders. Coupling will be changed out prior to shipping if a non-TW standard coupling size is needed.
- Data subject to change without notice.

VERTICAL HOLLOW SHAFT WPI HIGH THRUST with "P" BASE - MEDIUM VOLTAGE



CCO02A



AMRKNH, PREMIUM EFFICIENCY (200 HP - 1000 HP) [VHKP]

Effective: 01-01-2022
Supersedes: 07-06-2021

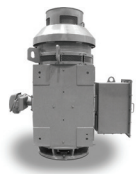

APPLICATIONS:

- Deep Well Turbine Pumps
- Irrigation
- Water/Wastewater

FEATURES:

- Output Range: 200 - 1000 HP
- Speed: 1800, 1200 RPM
- Enclosure: Weather Protected Type I (WPI)
- Voltage: 2300/4000V
- Three Phase, 60 Hz, 1.15 Service Factor (Continuous on Sine Wave Power)
- Inverter Duty (PWM) per NEMA® MG-1 Part 31 at 1.0 Service Factor
- Standard Features: Coupling w/ Gib Key, Ball Type NRR, Drip/Splash Cover, Space Heaters (120V)
- 5000 Frames and Above also include Mounting Provisions for bearing RTDs and Insulated Bearing Housing
- Class F Insulation with VPI Epoxy Resin Varnish
- Class B Temperature Rise
- NEMA Design B Torques
- Oversized Main Conduit Box Rotatable in 90 Degree Increments - Fully Gasketed with NPT Threaded Entrance
- Cast Iron Conduit Box for F#449TP and Below; Steel Plate Conduit Box for F#5000
- Designed for 40°C Ambient Temperature¹
- Designed for 3300 ft. Elevation²
- Counterclockwise (CCW) Rotation; Viewed from Top
- Cast Iron Frame & End Brackets
- 1045 Hollow Carbon Steel Shaft
- Aluminum Die Cast Squirrel Cage Rotor Construction for F#449TP and Below, 4pole; 6-8 pole copper fabricated rotor
- Squirrel Cage Copper or Copper Alloy Bar Rotor Construction for F#5000 and above
- Paint System: Paint System Epoxy Base Coat Plus Polyurethane Top Cover
- Paint Color: Blue - Munsell 5PB 3/8
- Guide Bearings: Re-Greasable with Mobil Polyrex™ EM Grease
- Thrust Bearings: 449TP frames are Oil Lubricated Oversized Angular Contact with Site Glass
- Thrust Bearings: 5000 Frame and above are Oil Lubricated Spherical Roller with Site Glass
- Oil Requirements: 300 S.S.U. @100°F
- Grounding Terminal Inside Main Box
- Stainless Steel Nameplate
- 6 Leads
- Suitable for Inverter Use per NEMA MG-1 Part 31.4.4.2
 - 10:1 Variable Torque with NRR; 20:1 Variable Torque without NRR Using Braking in VFD
- Precautions should be taken to eliminate or reduce shaft currents that may be imposed on the motor by VFD as stated per NEMA MG-1. Part 31.

EXTRAS/ OPTIONS:

Please refer to pages 147 - 152 for common modifications that can be performed.

Notes:

1. Consult a Stock Product Application Specialist for suitability in higher ambient environments.
2. Consult a Stock Product Application Specialist for suitability at higher elevations.

VERTICAL HOLLOW SHAFT WPI HIGH THRUST with "P" BASE - MEDIUM VOLTAGE



CCO02A



AMRKNH, PREMIUM EFFICIENCY [VHKP]

Effective: 01-01-2022
Supercedes: 07-06-2021

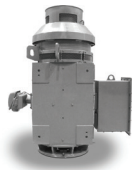

CATALOG NUMBER	HP	RPM	FRAME	FL EFF %	FL PF %	FL AMPS (4000V)	DOWN THRUST (lbs.)	BD DIM (in.)	CD DIM (in.)	BX DIM (in.)	APPROX. SHIPPING WT. (lbs.)	LIST PRICE (\$)
VHKP2006	200	1200	449TP	94.9	81.0	25.5	11,300	20.0	53.91	1.938	3,420	73,978
VHKP2504	250	1800	449TP	95.0	82.2	30.0	10,100	20.0	53.91	1.938	3,510	67,866
VHKP2506	250	1200	449TP	95.0	80.0	31.5	11,300	20.0	53.91	1.938	3,730	76,466
VHKP3004	300	1800	449TP	95.0	83.8	35.5	10,100	20.0	53.91	1.938	3,610	68,117
VHKP3006	300	1200	5009	95.0	77.6	38.0	33,800	24.5	57.06	2.188	4,020	110,098
VHKP3504	350	1800	5009	95.0	86.7	40.0	30,900	24.5	57.06	2.188	3,630	107,215
VHKP3506	350	1200	5009	95.0	75.9	45.5	33,800	24.5	57.06	2.188	4,010	118,566
VHKP4004	400	1800	5009VP	95.0	86.8	45.5	30,900	24.5	57.06	2.188	3,710	114,799
VHKP4006	400	1200	5009	95.0	75.6	52.0	33,800	24.5	57.06	2.188	4,880	120,963
VHKP4504	450	1800	5009	95.0	87.1	51.0	30,900	24.5	57.06	2.188	3,810	116,038
VHKP4506	450	1200	5806	95.0	80.2	55.5	33,600	30.5	55.39	2.438	4,510	135,449
VHKP5004	500	1800	5009	95.0	87.6	56.5	30,900	24.5	57.06	2.188	3,980	122,460
VHKP5006	500	1200	5806	95.0	80.2	61.5	33,600	30.5	55.39	2.438	4,610	137,230
VHKP6004	600	1800	5808	95.4	86.0	69.0	30,600	30.5	61.30	2.438	5,240	150,162
VHKP6006	600	1200	5808	95.0	80.3	73.5	33,300	30.5	61.30	2.438	5,660	141,999
VHKP7004	700	1800	5810	95.4	86.0	80.0	30,100	30.5	68.78	2.438	5,650	155,212
VHKP7006	700	1200	5808	95.0	81.2	85.0	33,300	30.5	61.30	2.438	5,340	150,939
VHKP8004	800	1800	5810	95.4	86.3	91.5	30,100	30.5	68.78	2.438	5,900	158,984
VHKP8006	800	1200	5810	95.0	80.7	97.5	33,000	30.5	68.78	2.438	5,720	158,125
VHKP9004	900	1800	5810	95.4	86.7	103	30,100	30.5	68.78	2.438	6,160	164,869
VHKP9006	900	1200	5810	95.0	81.5	109	33,000	30.5	68.78	2.438	5,960	167,206
VHKP10004	1000	1800	5810	95.4	87.3	113	30,100	30.5	68.78	2.438	6,510	170,993

Notes:

1. See page 130 in order to confirm the TWMC standard coupling size is suitable for customer requirements or to select an alternate coupling size. Required coupling size must be noted on all vertical hollow shaft motors orders. Coupling will be changed out prior to shipping if a non-TWMC standard coupling size is needed.
2. Data subject to change without notice.

VERTICAL HOLLOW SHAFT TEFC HIGH THRUST with "P" BASE - MEDIUM VOLTAGE



AEHCNH, PREMIUM EFFICIENCY (200HP - 700HP) [VHKTP]

Effective: 01-01-2022
Supersedes: 07-06-2021



APPLICATIONS:

- Deep Well Turbine Pumps
- Irrigation
- Water/Wastewater

FEATURES:

- Output Range: 200 - 700 HP
- Speed: 1800 & 1200 RPM
- Enclosure: Totally Enclosed Fan Cooled (IP54)
- Voltage: 2300/4000V
- Motors Suitable for Reduced Starting Voltage
- Three Phase, 60 Hz, 1.15 Service Factor (Continuous on Sine Wave Power)
- Inverter Duty (PWM) per NEMA MG-1 Part 31 at 1.0 Service Factor
- Standard Features: Coupling w/ Gib Key, Non-Sparking Ball Type NRR, Drip/Splash Cover, Space Heaters (120V)
- 5000 Frames and Above also include Mounting Provisions for bearing RTD's and Insulated Bearing Housing
- CSA Certified for Class I, Div. 2, Groups B,C, D; Temp Code T3 minimum
- Class F Insulation with VPI Epoxy Resin Varnish
- Class B Temperature Rise
- NEMA Design B Torques
- Oversized Main Conduit Box Rotatable in 90 Degree Increments - Fully Gasketed with NPT Threaded Entrance
- Steel Plate Conduit Box with Threaded Connection Opening(s)
- Designed for 40°C Ambient Temperature¹
- Designed for 3300 ft. Elevation²
- Oversized Angular Contact or Spherical Thrust Bearing Installed
- Counterclockwise (CCW) Rotation; Viewed from Top
- Cast Iron Frame & End Brackets
- 1045 Hollow Carbon Steel Shaft
- Aluminum Die Cast Squirrel Cage Rotor Construction for F#449TP
- Squirrel Cage Copper or Copper Alloy Bar Rotor Construction for F#5000 and Above
- Paint System: Phenolic Rust Proof Base Plus Polyurethane Top Coat
- Paint Color: Blue - Munsell 5PB 3/8
- Vacuum De-Gassed Re-Greasable Ball Bearings Frames -5007P & Up with Mobil Polyrex™ EM Grease
- Guide Bearings: 324TP - 5810P Frames are Re-Greasable with Mobil Polyrex™ EM Grease
- Thrust Bearings: 449TP frames are Oil Lubricated Oversized Angular Contact with Site Glass, 5009 - 5810P Frames are Oil Lubricated Angular Contact or Spherical Thrust Bearing with Site Glass
- Oil Requirements for 444TP - 5810P Frames: 300 S.S.U. @ 100°F
- Grease Discharge Fittings on Frames with Re-Greasable Motors
- Bronze Metal Flinger on Lower End Bracket
- Grounding Terminal Inside Main Box
- Stainless Steel Nameplate
- Suitable for Inverter Use per NEMA MG-1 Part 31.4.4.2
- Speed Ranges: 10:1 Variable Torque
- 6 Leads
- UL Recognized and CSA Approved
- Precautions should be taken to eliminate or reduce shaft currents that may be imposed on the motor by VFD as stated per NEMA MG-1. Part 31.
- Ball Type NRR Provided

EXTRAS/ OPTIONS:

Please refer to pages 147 - 152 for common modifications that can be performed.

Notes:

1. Consult a Stock Product Application Specialist for suitability in higher ambient environments.
2. Consult a Stock Product Application Specialist for suitability at higher elevations.

VERTICAL HOLLOW SHAFT TEFC HIGH THRUST with "P" BASE - MEDIUM VOLTAGE



CCO02A



AEHCNH, PREMIUM EFFICIENCY (150 HP - 700 HP) [VHKTP]

Effective: 01-01-2022

Supersedes: 07-06-2021



CATALOG NUMBER	HP	RPM	FRAME	FL EFF %	FL PF %	FL AMPS (4000V)	DOWN THRUST (lbs.)	BD DIM (in.)	CD DIM (in.)	BX DIM (in.)	APPROX. SHIPPING WT. (lbs.)	LIST PRICE (\$)
VHKTP1506	150	1200	449TP	95.0	80.1	18.0	11,400	20.0	53.94	2.126	2,850	74,747
VHKTP2004	200	1800	449TP	95.0	82.9	23.5	10,000	20.0	53.94	2.126	2,720	74,966
VHKTP2006	200	1200	449TP	95.0	76.2	25.5	11,400	20.0	53.94	2.126	3,700	78,329
VHKTP2504	250	1800	449TP	95.0	83.7	29.0	10,000	20.0	53.94	2.126	3,780	76,094
VHKTP2506	250	1200	5009P	95.0	81.9	30.0	12,100	24.5	57.20	2.188	3,980	100,404
VHKTP2508	250	900	5009P	95.0	79.8	30.5	13,200	24.5	57.20	2.188	4,690	107,622
VHKTP3004	300	1800	5009P	95.4	85.5	34.0	10,500	24.5	57.20	2.188	3,990	99,954
VHKTP3006	300	1200	5009P	95.0	82.4	35.5	12,100	24.5	57.20	2.188	5,530	104,268
VHKTP3008	300	900	5808P	95.0	77.3	39.0	24,300	30.5	62.09	2.376	6,300	141,326
VHKTP3504	350	1800	5009P	95.4	86.1	39.5	10,500	24.5	57.20	2.188	5,310	111,621
VHKTP3506	350	1200	5808P	95.2	80.4	42.5	22,300	30.5	62.09	2.376	5,960	136,849
VHKTP3508	350	900	5808P	95.0	77.2	44.5	24,300	30.5	62.09	2.376	6,640	146,588
VHKTP4004	400	1800	5009P	95.4	85.7	45.5	10,500	24.5	57.20	2.188	5,780	112,688
VHKTP4006	400	1200	5808P	95.4	80.8	48.5	22,300	30.5	62.09	2.376	6,300	141,332
VHKTP4008	400	900	5808P	95.0	77.3	50.5	24,300	30.5	62.09	2.376	6,980	153,961
VHKTP4504	450	1800	5808P	95.4	83.8	52.5	9,700	30.5	62.09	2.376	6,260	138,955
VHKTP4506	450	1200	5808P	95.6	80.9	54.0	22,300	30.5	62.09	2.376	6,560	145,380
VHKTP4508	450	900	5810P	95.0	77.1	57.5	24,300	30.5	67.20	2.376	7,580	159,206
VHKTP5004	500	1800	5808P	95.5	82.6	59.0	9,700	30.5	62.09	2.376	6,480	157,341
VHKTP5006	500	1200	5810P	95.8	81.6	59.5	22,300	30.5	67.20	2.376	6,880	167,748
VHKTP5008	500	900	5810P	95.4	76.8	63.5	24,300	30.5	67.20	2.376	7,790	140,502
VHKTP6004	600	1800	5810P	95.7	84.3	69.5	9,700	30.5	67.20	2.376	6,850	152,090
VHKTP6006	600	1200	5810P	96.0	81.3	71.5	22,300	30.5	67.20	2.376	9,120	161,614
VHKTP7004	700	1800	5810P	95.9	84.6	80.5	9,700	30.5	67.20	2.376	9,000	158,675

Notes:

1. See page 131 in order to confirm the TWMC standard coupling size is suitable for customer requirements or to select an alternate coupling size. Required coupling size must be noted on all vertical hollow shaft motors orders. Coupling will be changed out prior to shipping if a non-TWMC standard coupling size is needed.
2. Data subject to change without notice.

COUPLING KITS WPI

FOR VERTICAL HOLLOW SHAFT MOTORS

Effective: 01-01-2022

Supersedes: 07-06-2021

Notes:

1. Tolerance on BX dimensions up to and including 1.500 inches diameter:
+0.001 inches, -0.000 inches; Larger than 1.500 inches diameter: +0.0015 in., -0.0000 in.
2. Dimension EW tolerance: +0.002 inches, -0.000 inches.
3. Dimension R tolerance: +0.010 inches, -0.000 inches.
4. "*" in the table denotes the standard coupling size for each frame.
5. One coupling is included with motor price. If purchased separately use list pricing.
6. Please consult Application Specialist for listings not shown.

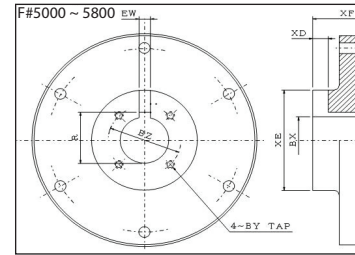
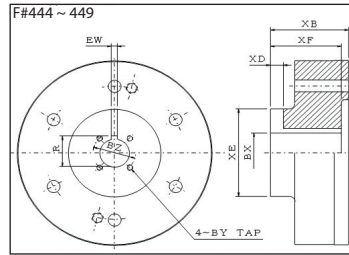
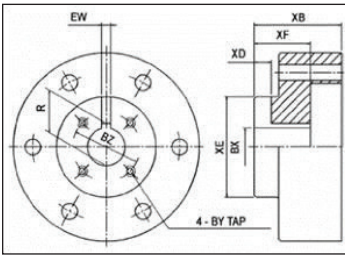

FRAME	BX	BY	BZ	EW	R	XB	XD	XE	XF	PART NUMBER	LIST PRICE (\$)
210TP	0.751	NO. 10-32 UNF	1.375	0.188	0.845	1.750	0.406	2.000	1.125	31010D6871903	460
	0.876	NO. 10-32 UNF	1.375	0.188	0.970	1.750	0.406	2.000	1.125	31010D6872004	460
	0.938	NO. 10-32 UNF	1.375	0.250	1.078	1.750	0.406	2.000	1.125	31010D6872101	460
	*1.001	NO. 10-32 UNF	1.375	0.250	1.126	1.750	0.406	2.000	1.125	31010D6872209	460
250TP/ 280TP	0.751	NO. 10-32 UNF	1.375	0.188	0.845	2.170	0.410	2.250	1.230	31010D6872306	613
	0.876	NO. 10-32 UNF	1.375	0.188	0.970	2.170	0.410	2.250	1.230	31010D6872403	613
	*1.001	NO. 10-32 UNF	1.375	0.250	1.126	2.170	0.410	2.250	1.230	31010D6872501	613
	1.188	1/4"-20 UNC	1.750	0.250	1.313	2.170	0.410	2.250	1.230	31010D6872608	613
	1.251	1/4"-20 UNC	1.750	0.250	1.376	2.170	0.410	2.250	1.230	31010D6872705	613
320TP/ 360TP	1.001	NO. 10-32 UNF	1.375	0.250	1.126	2.540	0.410	2.875	1.540	31010D6872802	920
	*1.188	1/4"-20 UNC	1.750	0.250	1.313	2.540	0.410	2.875	1.540	31010D6872900	920
	1.251	1/4"-20 UNC	1.750	0.250	1.376	2.540	0.410	2.875	1.540	31010D6873001	920
	1.438	1/4"-20 UNC	2.125	0.375	1.625	2.540	0.470	2.875	1.540	31010D6873108	920
	1.501	1/4"-20 UNC	2.125	0.375	1.688	2.540	0.470	2.875	1.540	31010D6873205	920
400TP	1.188	1/4"-20 UNC	1.750	0.250	1.313	2.760	0.530	3.150	1.500	31010D6873302	1,278
	1.251	1/4"-20 UNC	1.750	0.250	1.376	2.760	0.530	3.150	1.500	31010D6873400	1,278
	1.438	1/4"-20 UNC	2.125	0.375	1.625	2.760	0.530	3.150	1.500	31010D6873507	1,278
	*1.501	1/4"-20 UNC	2.125	0.375	1.688	2.760	0.530	3.150	1.500	31010D6873604	1,278
	1.688	1/4"-20 UNC	2.500	0.375	1.891	2.760	0.530	3.150	1.500	31010D6873701	1,278
444TP/ 445TP	1.751	1/4"-20 UNC	2.500	0.375	1.954	2.760	0.530	3.150	1.500	31010D6873809	1,278
	1.188	1/4"-20 UNC	1.750	0.250	1.304	3.169	0.409	3.740	2.875	3A010C2390104	2,150
	1.251	1/4"-20 UNC	1.750	0.250	1.367	3.169	0.409	3.740	2.875	3A010C2390201	2,150
	1.438	1/4"-20 UNC	2.125	0.375	1.605	3.169	0.531	3.740	2.875	3A010C2390309	2,150
	*1.501	1/4"-20 UNC	2.125	0.375	1.669	3.169	0.531	3.740	2.875	3A010C2390406	2,150
	1.688	1/4"-20 UNC	2.500	0.375	1.859	3.169	0.531	3.740	2.875	3A010C2390503	2,150
	1.751	1/4"-20 UNC	2.500	0.375	1.922	3.169	0.531	3.740	2.875	3A010C2390601	2,150
445TP20 ^(A) / 447TP ^(B) / 449TP ^(C)	1.938	1/4"-20 UNC	2.500	0.500	2.160	3.169	0.689	3.740	2.875	3A010C2390708	2,150
	1.438	1/4"-20 UNC	2.125	0.375	1.605	3.559	0.531	4.725	3.071	3A010C2390805	2,350
	*1.501 ^(A)	1/4"-20 UNC	2.125	0.375	1.669	3.559	0.531	4.725	3.071	3A010C2390902	2,350
	*1.688 ^(B)	1/4"-20 UNC	2.500	0.375	1.859	3.559	0.531	4.725	3.071	3A010C2391003	2,350
	1.751	1/4"-20 UNC	2.500	0.375	1.922	3.559	0.531	4.725	3.071	3A010C2391101	2,350
	*1.938 ^(C)	1/4"-20 UNC	2.500	0.500	2.160	3.559	0.689	4.725	3.071	3A010C2391208	2,350
	2.001	3/8"-16 UNC	3.250	0.500	2.223	3.559	0.689	4.725	3.071	3A010C2391305	2,350
	2.063	3/8"-16 UNC	3.250	0.500	2.287	3.559	0.689	4.725	3.071	3A010C2391402	2,350
	2.126	3/8"-16 UNC	3.250	0.500	2.350	3.559	0.689	4.725	3.071	3A010C2391500	2,350
	2.188	3/8"-16 UNC	3.250	0.500	2.414	3.559	0.689	4.725	3.071	3A010C2391607	2,350
	2.251	3/8"-16 UNC	3.250	0.500	2.477	3.559	0.689	4.725	3.071	3A010C2391704	2,350
	2.376	3/8"-16 UNC	3.250	0.625	2.651	3.559	0.815	4.725	3.071	3A010C2391801	2,350
	2.438	3/8"-16 UNC	3.250	0.625	2.714	3.559	0.815	4.725	3.071	3A010C2391909	2,350
2.501	3/8"-16 UNC	3.250	0.625	2.778	3.559	0.815	4.725	3.071	3A010C2392000	2,350	
5000 ^(A) / 5800 ^(B)	1.688	1/4"-20 UNC	2.500	0.375	1.859	-	0.531	4.725	3.071	3A711C1371209X001	2,650
	1.938	1/4"-20 UNC	2.500	0.500	2.160	-	0.689	4.725	3.071	3A711C1371306X001	2,650
	2.126	3/8"-16 UNC	3.250	0.500	2.350	-	0.689	4.725	3.071	3A711C1371403X001	2,650
	*2.188 ^(A)	3/8"-16 UNC	3.250	0.500	2.414	-	0.689	4.725	3.071	3A711C1371501X001	2,650
	2.251	3/8"-16 UNC	3.250	0.500	2.477	-	0.689	4.725	3.071	3A711C1370407X001	2,650
	2.376	3/8"-16 UNC	3.250	0.625	2.651	-	0.815	4.725	3.071	3A711C1370300X001	2,650
	*2.438 ^(B)	3/8"-16 UNC	3.250	0.625	2.714	-	0.815	4.725	3.071	3A711C1370202X001	2,650
	2.501	3/8"-16 UNC	3.250	0.625	2.778	-	0.815	4.725	3.071	3A711C1370105X001	2,650
BLANK1	3/8"-16 UNC	3.250	-	-	-	-	4.725	3.071	3A711C1370504X001	2,650	
BLANK2	-	-	-	-	-	-	4.725	3.071	3A711C1370601X001	2,650	

COUPLING KITS TEFC

FOR VERTICAL HOLLOW SHAFT MOTORS

Effective: 01-01-2022

Supersedes: 07-06-2021

Notes:

1. Tolerance on BX dimensions up to and including 1.500 inches diameter: +0.001 inches, -0.000 inches; Larger than 1.500 in. diameter: +0.0015 in., -0.000 in.
2. Dimension EW tolerance: +0.002 inches, -0.000 inches.
3. Dimension R tolerance: +0.010 inches, -0.000 inches.
4. ****#** in the table denotes the standard coupling size for each frame.**
5. One coupling is included with motor price. If purchased separately, use list pricing.
6. Please consult Application Specialist for listings not shown.

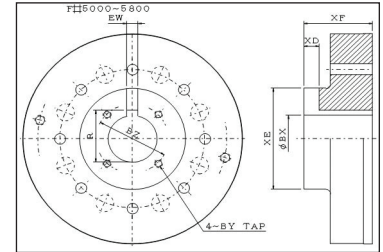
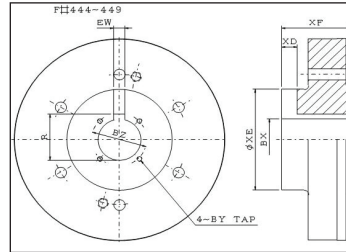
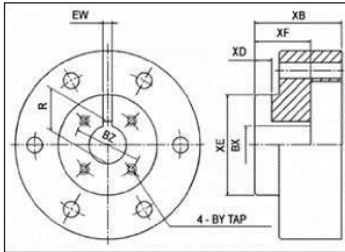

FRAME	BX	BY	BZ	EW	R	XB	XD	XE	XF	PART NUMBER	LIST PRICE (\$)
210TP	0.751	NO. 10-32 UNF	1.375	0.188	0.845	1.750	0.343	2.000	1.125	31010D6870206	460
	0.876	NO. 10-32 UNF	1.375	0.188	0.970	1.750	0.343	2.000	1.125	31010D6870303	460
	*1.001	NO. 10-32 UNF	1.375	0.250	1.126	1.750	0.406	2.000	1.125	31010D6870401	460
250TP	0.751	NO. 10-32 UNF	1.375	0.188	0.845	2.560	0.343	2.250	1.625	31010D6870508	613
	0.876	NO. 10-32 UNF	1.375	0.188	0.970	2.560	0.343	2.250	1.652	31010D6870605	613
	*1.001	NO. 10-32 UNF	1.375	0.250	1.126	2.560	0.406	2.250	1.625	31010D6870702	613
280TP	1.188	1/4"-20 UNC	1.750	0.250	1.313	2.560	0.406	2.250	1.652	31010D6870800	613
	0.876	NO. 10-32 UNF	1.375	0.188	0.970	2.560	0.343	2.250	1.652	31010D6870605	613
	*1.001	NO. 10-32 UNF	1.375	0.250	1.126	2.560	0.406	2.250	1.625	31010D6870702	613
320TP	1.188	1/4"-20 UNC	1.750	0.250	1.313	2.560	0.406	2.250	1.652	31010D6870800	613
	1.251	1/4"-20 UNC	1.750	0.250	1.376	2.560	0.406	2.250	1.652	31010D6870907	613
	1.438	1/4"-20 UNC	2.125	0.375	1.625	3.331	0.531	2.875	2.331	31010D6871008	920
360TP	*1.188	1/4"-20 UNC	1.750	0.250	1.313	3.331	0.406	2.875	2.331	31010D6871105	920
	1.251	1/4"-20 UNC	1.750	0.250	1.376	3.331	0.406	2.875	2.331	31010D6871202	920
	1.438	1/4"-20 UNC	2.125	0.375	1.625	3.331	0.531	2.875	2.331	31010D6871300	920
400TP	1.501	1/4"-20 UNC	2.125	0.375	1.688	3.331	0.531	2.875	2.331	31010D6871709	920
	1.188	1/4"-20 UNC	1.750	0.250	1.313	2.760	0.530	3.150	1.500	31010D6873302	2,150
	1.251	1/4"-20 UNC	2.125	0.375	1.688	3.543	0.531	3.150	2.441	31010D6873906	2,150
444TP/ 445TP	1.438	1/4"-20 UNC	2.125	0.375	1.688	3.543	0.531	3.150	2.441	31010D6874007	2,150
	*1.501	1/4"-20 UNC	2.125	0.375	1.688	3.543	0.531	3.150	2.441	31010D6871806	2,150
	1.688	1/4"-20 UNC	2.500	0.375	1.688	3.543	0.531	3.740	2.874	31010D6874104	2,150
447TP ^(A) / 449TP ^(B)	1.188	1/4"-20 UNC	1.750	0.250	1.304	-	0.409	3.740	2.874	3A711C1580100X001	2,150
	1.251	1/4"-20 UNC	1.750	0.250	1.367	-	0.409	3.740	2.874	3A711C1580207X001	2,150
	1.438	1/4"-20 UNC	2.125	0.375	1.605	-	0.531	3.740	2.874	3A711C1580304X001	2,150
5000 ^(A) / 5800-4P ^(B)	*1.501	1/4"-20 UNC	2.125	0.375	1.669	-	0.531	3.740	2.874	3A711C1580401X001	2,150
	1.688	1/4"-20 UNC	2.500	0.375	1.859	-	0.531	3.740	2.874	3A711C1580509X001	2,150
	1.751	1/4"-20 UNC	2.500	0.375	1.922	-	0.531	3.740	2.874	3A711C1580606X001	2,150
5800-6P & ABOVE	1.938	1/4"-20 UNC	2.500	0.500	2.160	-	0.689	3.740	2.874	3A711C1580703X001	2,150
	1.438	1/4"-20 UNC	2.125	0.375	1.605	-	0.531	4.725	3.071	3A711C1590105X001	2,350
	1.501	1/4"-20 UNC	2.125	0.375	1.669	-	0.531	4.725	3.071	3A711C1590202X001	2,350
5800-6P & ABOVE	*1.688^(A)	1/4"-20 UNC	2.500	0.375	1.859	-	0.531	4.725	3.071	3A711C1590300X001	2,350
	1.751	1/4"-20 UNC	2.500	0.375	1.922	-	0.531	4.725	3.071	3A711C1590407X001	2,350
	*1.938^(B)	1/4"-20 UNC	2.500	0.500	2.160	-	0.689	4.725	3.071	3A711C1590504X001	2,350
5800-6P & ABOVE	2.001	3/8"-16 UNC	3.250	0.500	2.223	-	0.689	4.725	3.071	3A711C1590601X001	2,350
	2.063	3/8"-16 UNC	3.250	0.500	2.287	-	0.689	4.725	3.071	3A711C1590709X001	2,350
	2.126	3/8"-16 UNC	3.250	0.500	2.350	-	0.689	4.725	3.071	3A711C1590806X001	2,350
5800-6P & ABOVE	2.188	3/8"-16 UNC	3.250	0.500	2.414	-	0.689	4.725	3.071	3A711C1590903X001	2,350
	2.251	3/8"-16 UNC	3.250	0.500	2.477	-	0.689	4.725	3.071	3A711C1591004X001	2,350
	2.376	3/8"-16 UNC	3.250	0.625	2.651	-	0.815	4.725	3.071	3A711C1591101X001	2,350
5800-6P & ABOVE	2.438	3/8"-16 UNC	3.250	0.625	2.714	-	0.815	4.725	3.071	3A711C1591209X001	2,350
	2.501	3/8"-16 UNC	3.250	0.625	2.778	-	0.815	4.725	3.071	3A711C1591306X001	2,350
	1.501	1/4"-20 UNC	2.125	0.375	1.669	-	0.531	4.725	3.071	3A711C1600101X001	2,650
5800-6P & ABOVE	1.688	1/4"-20 UNC	2.500	0.375	1.859	-	0.531	4.725	3.071	3A711C1600208X001	2,650
	1.938	1/4"-20 UNC	2.500	0.500	2.160	-	0.689	4.725	3.071	3A711C1600305X001	2,650
	2.126	3/8"-16 UNC	3.250	0.500	2.350	-	0.689	4.725	3.071	3A711C1600402X001	2,650
5800-6P & ABOVE	*2.188^(A)	3/8"-16 UNC	3.250	0.500	2.414	-	0.689	4.725	3.071	3A711C1600500X001	2,650
	2.376	3/8"-16 UNC	3.250	0.625	2.651	-	0.815	4.725	3.071	3A711C1600607X001	2,650
	*2.438^(B)	3/8"-16 UNC	3.250	0.625	2.714	-	0.815	4.725	3.071	3A711C1600704X001	2,650
5800-6P & ABOVE	1.501	1/4"-20 UNC	2.125	0.375	1.669	-	0.531	4.725	3.071	3A711C1630107X001	2,650
	1.688	1/4"-20 UNC	2.500	0.375	1.859	-	0.531	4.725	3.071	3A711C1630204X001	2,650
	1.938	1/4"-20 UNC	2.500	0.500	2.160	-	0.689	4.725	3.071	3A711C1630301X001	2,650
5800-6P & ABOVE	2.126	3/8"-16 UNC	3.250	0.500	2.350	-	0.689	4.725	3.071	3A711C1630409X001	2,650
	2.188	3/8"-16 UNC	3.250	0.500	2.414	-	0.689	4.725	3.071	3A711C1630506X001	2,650
	2.376	3/8"-16 UNC	3.250	0.625	2.651	-	0.815	4.725	3.071	3A711C1630603X001	2,650
5800-6P & ABOVE	*2.438	3/8"-16 UNC	3.250	0.625	2.714	-	0.815	4.725	3.071	3A711C1630701X001	2,650

STEADY BUSHING KITS WPI

FOR VERTICAL HOLLOW SHAFT MOTORS

Effective: 01-01-2022

Supercedes: 07-06-2021

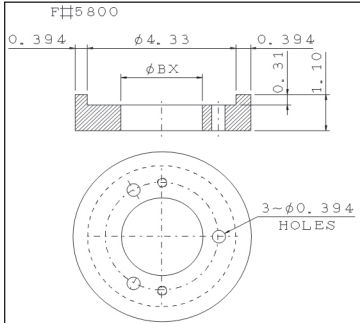
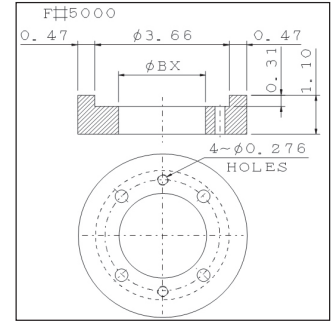
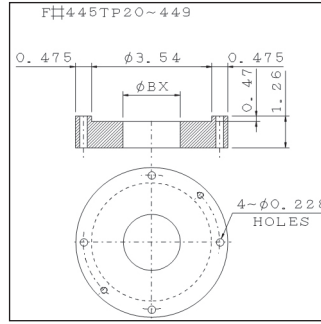
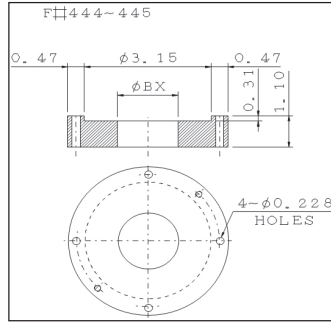
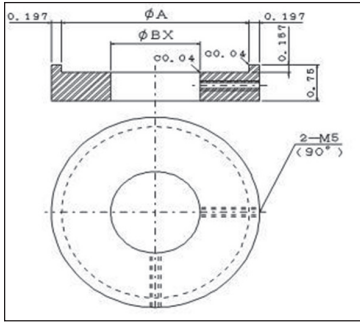

Notes:

1. See corresponding diagram for part detail.
2. Please consult Application Specialist for listings not shown.
3. Steady Bushing material is Bronze.
4. Kit includes hardware.
5. Steady bushing kits are the same for WPI and TEFC for frames 449TP and smaller.
6. "*" in the table denotes the standard size for each frame.

FRAME	A	BX	PART NUMBER	LIST PRICE (\$)
210TP	1.77	0.751	31010D4974705	200
		0.876	31010D4974802	200
		0.938	31010D4974900	200
		*1.001	31010D4975001	200
250TP	1.77	0.751	31010D4974705	200
		0.876	31010D4974802	200
		*1.001	31010D4975001	200
		1.188	31010D4975108	200
		1.251	31010D4975205	200
280TP	2.17	0.751	31010D4975302	200
		0.876	31010D4975400	200
		*1.001	31010D4975507	200
		1.188	31010D4975604	200
		1.251	31010D4975701	200
320TP	2.83	1.001	31010D4975809	260
		*1.188	31010D4975906	260
		1.251	31010D4976007	260
		1.438	31010D4976104	260
360TP	3.03	1.501	31010D4976201	260
		1.001	31010D4976309	260
		*1.188	31010D4976406	260
		1.251	31010D4976503	260
400TP	3.54	1.438	31010D4976601	260
		1.501	31010D4976708	260
		1.188	31010D4976805	300
		1.251	31010D4976902	300
		*1.501	31010D4977101	300
		1.688	31010D4977208	300
		1.751	31010D4977305	300

FRAME	A	BX	PART NUMBER	LIST PRICE (\$)
444TP/ 445TP	3.15	1.188	3A702D1611403X001	525
		1.251	3A702D1611501X001	525
		1.438	3A702D1611608X001	525
		*1.501	3A702D1611705X001	525
		1.688	3A702D1611802X001	525
		1.751	3A702D1611900X001	525
445TP20 ^(A) / 447TP ^(B) / 449TP ^(C)	3.54	1.938	3A702D1612001X001	525
		1.938	3A702D1610105X001	630
		*1.501 ^(A)	3A702D1610202X001	630
		*1.688 ^(A)	3A702D1610300X001	630
		1.751	3A702D1610407X001	630
		*1.938	3A702D1610504X001	630
		2.001	3A702D1610601X001	630
		2.063	3A702D1610709X001	630
		2.126	3A702D1610806X001	630
		2.188	3A702D1610903X001	630
		2.251	3A702D1611004X001	630
5000	3.66	2.376	3A702D1611101X001	630
		2.438	3A702D1611209X001	630
		2.501	3A702D1611306X001	630
		1.688	3A702D1720601X001	630
		1.938	3A702D1720709X001	630
		2.126	3A702D1720806X001	630
		*2.188	3A702D1720202X001	630
		2.251	3A702D1720903X001	630
5800	4.33	2.376	3A702D1720300X001	630
		2.438	3A702D1720407X001	630
		2.501	3A702D1720504X001	630
		2.126	3A702D1740602X001	630
		2.188	3A702D1740505X001	630
		*2.438	3A702D1740203X001	630
		2.251	3A702D1740408X001	630
		2.376	3A702D1740301X001	630
		2.501	3A702D1740106X001	630

STEADY BUSHING KITS TEFC

FOR VERTICAL HOLLOW SHAFT MOTORS

Effective: 01-01-2022

Supersedes: 07-06-2021

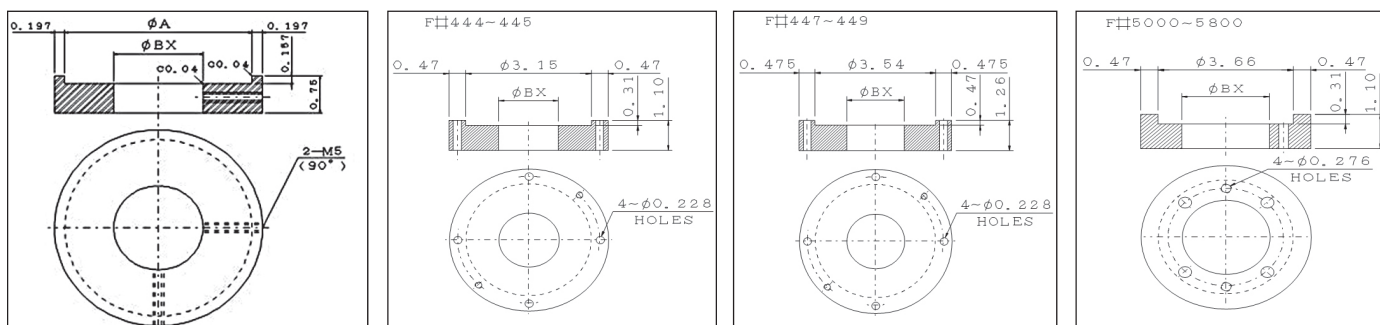

Notes:

1. See corresponding diagram for part detail.
2. Please consult Application Specialist for listings not shown.
3. Steady Bushing material is Bronze.
4. Kit includes hardware.
5. Steady bushing kits are the same for WPI and TEFC for frames 449TP and smaller.
6. "*" in the table denotes the standard size for each frame.

FRAME	A	BX	PART NUMBER	LIST PRICE (\$)
210TP	1.77	0.751	31010D4974705	200
		0.876	31010D4974802	200
		0.938	31010D4974900	200
		*1.001	31010D4975001	200
250TP	1.77	0.751	31010D4974705	200
		0.876	31010D4974802	200
		*1.001	31010D4975001	200
		1.188	31010D4975108	200
		1.251	31010D4975205	200
280TP	2.17	0.751	31010D4975302	200
		0.876	31010D4975400	200
		*1.001	31010D4975507	200
		1.188	31010D4975604	200
		1.251	31010D4975701	200
320TP	2.36	1.001	31010D4975809	260
		*1.188	31010D4975906	260
		1.251	31010D4976007	260
		1.438	31010D4976104	260
		1.501	31010D4976201	260
360TP	3.03	1.001	31010D4976309	260
		*1.188	31010D4976406	260
		1.251	31010D4976503	260
		1.438	31010D4976601	260
400TP	3.54	1.501	31010D4976708	260
		1.188	31010D4976805	300
		1.251	31010D4976902	300
		1.438	31010D4977003	300
		*1.501	31010D4977101	300
		1.688	31010D4977208	300
		1.751	31010D4977305	300

FRAME	A	BX	PART NUMBER	LIST PRICE (\$)
444TP/ 445TP	3.15	1.188	3A702D1611403X001	525
		1.251	3A702D1611501X001	525
		1.438	3A702D1611608X001	525
		*1.501	3A702D1611705X001	525
		1.688	3A702D1611802X001	525
		1.751	3A702D1611900X001	525
447TP ^(A) / 449TP ^(B)	3.54	1.938	3A702D1612001X001	525
		1.438	3A702D1610105X001	630
		1.501	3A702D1610202X001	630
		*1.688 ^(A)	3A702D1610300X001	630
		1.751	3A702D1610407X001	630
		*1.938 ^(B)	3A702D1610504X001	630
		2.001	3A702D1610601X001	630
		2.063	3A702D1610709X001	630
		2.126	3A702D1610806X001	630
		2.188	3A702D1610903X001	630
		2.251	3A702D1611004X001	630
5000 ^(A) / 5800 ^(B)	3.66	2.376	3A702D1611101X001	630
		2.438	3A702D1611209X001	630
		2.501	3A702D1611306X001	630
		1.688	3A702D1720601X001	630
		1.938	3A702D1720709X001	630
		2.126	3A702D1720806X001	630
		*2.188 ^(A)	3A702D1720202X001	630
		2.251	3A702D1720903X001	630
		2.376	3A702D1720300X001	630
		*2.438 ^(B)	3A702D1720407X001	630
2.501	3A702D1720504X001	630		

VERTICAL SOLID SHAFT WPI HIGH THRUST with "P" BASE - LOW VOLTAGE



CCO02A



AMRCED (MAX-VSP™) NEMA PREMIUM (15 HP - 800 HP) [VSP]*

Effective: 01-01-2022

AMRCED (MAX-VSP™) NEMA PREMIUM (15 HP - 400 HP) [VSP_FP]*

Supersedes: 07-06-2021

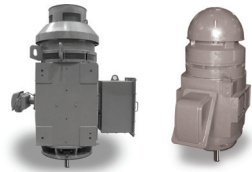

FIRE SAFETY

APPLICATIONS:

- Deep Well Turbine Pumps
- Fluid Handling Systems
- Irrigation
- Water/Wastewater
- Fire Pumps

FEATURES:

- Output Range: 15 - 800 HP
- Speed: 1800, 1200 RPM
- Enclosure: Weather Protected Type I (WPI)
- Voltage: 230/460V(Usable on 208V); 150HP and Larger is 460V Only
- Three Phase, 60 Hz, 1.15 Service Factor (Continuous on Sine Wave Power)
- Inverter Duty (PWM) per NEMA® MG-1 Part 31 at 1.0 Service Factor
- Dual Column (60/50 Hz) Design Nameplate as Standard; 50 Hz Data 190/380V at 1.0 S.F.
- Standard Features: Ball Type NRR, Drip/Splash Cover, Space Heaters (120V)
- 5000 Frames and Above also include Mounting Provisions for bearing RTD's and Insulated Bearing Housing
- Class F Insulation with Phenolic Alkyd Resin Varnish
- Class B Temperature Rise
- NEMA Design B Torques
- Oversized Main Conduit Box Rotatable in 90 Degree Increments - Fully Gasketed with NPT Threaded Entrance
- Cast Iron Conduit Box for F#449VP and Below; Steel Plate Conduit Box for F#5000
- Designed for 40°C Ambient Temperature¹
- Designed for 3300 ft. Elevation²
- Counterclockwise (CCW) Rotation; Viewed from Top
- Cast Iron Frame & End Brackets
- 1045 Solid Carbon Steel Shaft
- Aluminum Die Cast Squirrel Cage Rotor Construction for F#449VP and Below
- Squirrel Cage Copper or Copper Alloy Bar Rotor Construction for F#5000
- Paint System: Phenolic Rust Proof Base Plus Polyurethane Top Coat
- Paint Color for AMRCED (MAX-VSP™): Blue - Munsell 5PB 3/8
- Guide Bearings: 254VP - 286VP frames are Grease Pre-packed Double Shielded Bearings (MULTEMP SRL)
324VP - 5009VP frames are Re-Greasable (Mobil Polyrex EM)
- Thrust Bearings: 254VP - 286VP frames are Re-Greasable Angular Contact (Mobil Polyrex EM);
324VP - 449VP frames are Oil Lubricated Angular Contact; F#5000 and Above with Spherical Roller
- Oil Requirements for 324VP-405VP - 145 to 175 S.S.U. @100°F
- Oil Requirements for 444VP-5810VP - 300 S.S.U. @100°F
- Grounding Terminal Inside Main Box
- Stainless Steel Nameplate and Rodent Screens
- 12 Leads (PWS on 230V), Wye/Delta on 230/460V for 210VP-400VP;⁽³⁾
6 Leads (PWS on 230V, Wye D on 460V for 444VP-5810VP)
- Suitable for Inverter Use per NEMA MG-1 Part 31.4.4.2
- 10:1 Variable Torque with NRR. 10:1 C.T., 20:1 VT without NRR Using Braking in VFD
- Precautions should be taken to eliminate or reduce shaft currents that may be imposed on the motor by VFD as stated per NEMA MG-1 Part 31.

EXTRAS/ OPTIONS:

Please refer to pages 147 - 152 for common modifications that can be performed.

Notes:

- * Fire Pump available. See product page for more details.
- 1. Consult a Stock Product Application Specialist for suitability in higher ambient environments.
- 2. Consult a Stock Product Application Specialist for suitability at higher elevations.
- 3. Suitable for Wye/Delta start at 230V or 460V.

MAX-VSP™ VERTICAL SOLID SHAFT WPI



AMRCED (MAX-VSP™) NEMA PREMIUM (15 HP - 800 HP) [VSP]*

Effective: 01-01-2022

LOW VOLTAGE

Supersedes: 07-06-2021



CATALOG NUMBER	HP	RPM	FRAME	FL EFF %	FL PF %	FL AMPS (460V)	DOWN THRUST (lbs.)	BD DIM (in.)	APPROX. SHIPPING WT. (lbs.)	MOTOR LIST PRICE (\$)
VSP0154	15	1800	254VP	93.0	83.0	18.2	3,350	10.0	309	5,203
VSP0204	20	1800	256VP	93.0	83.0	24.3	3,350	10.0	330	5,202
VSP0254	25	1800	284VP	93.6	85.0	29.4	3,350	10.0	425	6,611
VSP0304	30	1800	286VP	94.1	86.0	34.7	3,350	10.0	465	7,039
VSP0404	40	1800	324VP	94.1	86.0	46.3	5,700	16.5	634	9,670
VSP0504	50	1800	326VP	94.5	85.0	58.5	5,700	16.5	689	10,100
VSP0604	60	1800	364VP	95.0	85.0	69.5	6,000	16.5	791	12,241
VSP0606	60	1200	404VP	94.5	85.5	69.5	9,000	16.5	1,094	22,321
VSP0754	75	1800	365VP	95.0	86.0	86.0	6,000	16.5	877	12,553
VSP0756	75	1200	405VP	94.5	86.5	86.0	9,000	16.5	1,239	22,781
VSP1004	100	1800	404VP	95.4	85.5	115	7,900	16.5	1,133	21,415
VSP1006	100	1200	444VP	95.0	82.0	120	12,000	16.5	1,450	39,726
VSP1254	125	1800	405VP	95.4	84.5	145	7,900	16.5	1,158	22,050
VSP1256	125	1200	445VP	95.0	82.0	150	11,900	16.5	1,650	40,644
VSP1504	150	1800	444VP	95.0	86.0	172	10,700	16.5	1,530	40,412
VSP1506	150	1200	445VP	95.4	82.5	178	11,800	16.5	1,890	42,014
VSP2004	200	1800	445VP	95.0	86.5	228	10,700	16.5	1,820	41,745
VSP2006	200	1200	447VP	95.4	83.0	236	14,900	20.0	2,130	48,046
VSP2504	250	1800	445VP20	95.8	86.5	283	13,400	20.0	1,940	49,382
VSP2506	250	1200	449VP	95.8	83.0	295	14,700	20.0	2,660	58,173
VSP3004	300	1800	447VP	95.8	87.5	335	13,400	20.0	2,470	52,276
VSP3006	300	1200	449VP	94.7	79.0	375	11,360	20.0	3,320	63,065
VSP3504	350	1800	447VP	95.8	88.0	388	13,300	20.0	2,900	56,801
VSP3506	350	1200	5009VP	95.8	84.5	405	33,900	24.5	4,050	92,284
VSP4004	400	1800	449VP	95.8	88.5	442	13,200	20.0	3,320	60,610
VSP4006	400	1200	5009VP	95.8	85.0	460	33,800	24.5	4,270	101,137
VSP4504	450	1800	5009VP	96.2	89.1	492	31,000	24.5	4,050	97,904
VSP4506	450	1200	5806VP	95.8	84.7	519	33,600	30.0	5,310	111,501
VSP5004	500	1800	5009VP	96.2	89.2	546	30,900	24.5	4,170	101,881
VSP5006	500	1200	5806VP	95.8	85.4	572	33,500	30.0	5,430	116,886
VSP6004	600	1800	5808VP	96.2	90.6	645	30,400	30.0	5,470	118,806
VSP6006	600	1200	5808VP	95.8	85.0	690	33,300	30.0	5,600	127,269
VSP7004	700	1800	5810VP	96.2	91.1	748	30,200	30.0	5,880	122,991
VSP7006	700	1200	5808VP	95.8	85.7	798	33,100	30.0	5,830	131,128
VSP8004	800	1800	5810VP	96.2	91.0	856	30,100	30.0	6,180	127,712
VSP8006	800	1200	5810VP	95.8	86.1	908	32,900	30.0	6,210	144,455

Notes:

- * Fire Pump available as made to order. Fire Pump Certificate complies with ANSI/UL 1004-5. Certificate# 20120717 - EX6569.
- 1. Delivery for Fire Pump Duty motor (Catalog Number + FP) is standard 5 - 10 working days after receipt of order if standard motor is in stock; Painting to Fire Safety Red requirement on Fire Pump Duty type motor can be waived in order to expedite delivery upon request.
- 2. Fire Pump Duty Motor pricing includes: adding UL nameplate, restamping original nameplate to new "VSP_FP" catalog number, and Fire Safety Red Paint.
- 3. Data subject to change without notice.

MAX-VSP™ VERTICAL SOLID SHAFT WPI



**AMRCED (MAX-VSP™) NEMA PREMIUM (15 HP - 400 HP) [VSP_FP] LOW VOLTAGE
FIRE PUMP***

Effective: 01-01-2022
Supersedes: 07-06-2021

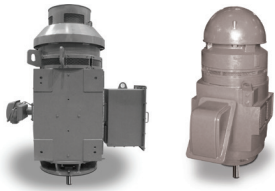

FIRE PUMP CATALOG NUMBER	HP	RPM	FRAME	FL EFF %	FL PF %	FL AMPS (460V)	DOWN THRUST (lbs.)	BD DIM (in.)	APPROX. SHIPPING WT. (lbs.)	FIRE PUMP LIST PRICE (\$)
VSP0154FP	15	1800	254VP	93.0	83.0	18.2	3,350	10.0	309	6,558
VSP0204FP	20	1800	256VP	93.0	83.0	24.3	3,350	10.0	330	6,864
VSP0254FP	25	1800	284VP	93.6	85.0	29.4	3,350	10.0	425	7,966
VSP0304FP	30	1800	286VP	94.1	86.0	34.7	3,350	10.0	465	8,394
VSP0404FP	40	1800	324VP	94.1	86.0	46.3	5,700	16.5	634	11,026
VSP0504FP	50	1800	326VP	94.5	85.0	58.5	5,700	16.5	689	11,455
VSP0604FP	60	1800	364VP	95.0	85.0	69.5	6,000	16.5	791	13,597
VSP0606FP	60	1200	404VP	94.5	85.5	69.5	9,000	16.5	1,094	23,675
VSP0754FP	75	1800	365VP	95.0	86.0	86.0	6,000	16.5	877	13,908
VSP0756FP	75	1200	405VP	94.5	86.5	86.0	9,000	16.5	1,239	24,137
VSP1004FP	100	1800	404VP	95.4	85.5	115	7,900	16.5	1,133	22,414
VSP1006FP	100	1200	444VP	95.0	82.0	120	12,000	16.5	1,450	41,038
VSP1254FP	125	1800	405VP	95.4	84.5	145	7,900	16.5	1,158	23,405
VSP1256FP	125	1200	445VP	95.0	82.0	150	11,900	16.5	1,650	43,347
VSP1504FP	150	1800	444VP	95.0	86.0	172	10,700	16.5	1,530	43,107
VSP1506FP	150	1200	445VP	95.4	82.5	178	11,800	16.5	1,890	44,762
VSP2004FP	200	1800	445VP	95.0	86.5	228	10,700	16.5	1,820	43,055
VSP2006FP	200	1200	447VP	95.4	83.0	236	14,900	20.0	2,130	49,358
VSP2504FP	250	1800	447VP20	95.8	86.5	283	13,400	20.0	1,940	50,768
VSP2506FP	250	1200	449VP	95.8	83.0	295	14,700	20.0	2,660	58,222
VSP3004FP	300	1800	447VP	95.8	87.5	335	13,400	20.0	2,470	52,459
VSP3006FP	300	1200	449VP	94.7	79.0	375	11,360	20.0	3,320	64,451
VSP3504FP	350	1800	447VP	95.8	88.0	388	13,300	20.0	2,900	58,187
VSP4004FP	400	1800	449VP	95.8	88.5	442	13,200	20.0	3,320	61,997

Notes:

- * Fire Pump available as made to order. Fire Pump Certificate complies with ANSI/UL 1004-5. Certificate# 20120717 - EX6569.
- 1. Delivery for Fire Pump Duty motor (Catalog Number + FP) is standard 5 - 10 working days after receipt of order if standard motor is in stock.
- 2. Fire Pump Duty Motor pricing includes: adding UL nameplate, restamping original nameplate to new "VSP_FP" catalog number.
- 3. Data subject to change without notice.

VERTICAL SOLID SHAFT TEFC HIGH THRUST with "P" BASE - LOW VOLTAGE



AEEHED (MAX-VSTP™) NEMA PREMIUM (15 HP - 800 HP) [VSTP]

Effective: 01-01-2022
Supercedes: 07-06-2021

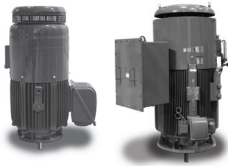

APPLICATIONS:

- Deep Well Turbine Pumps
- Irrigation
- Water/Wastewater

FEATURES:

- Output Range: 15 - 800 HP
- Speed: 1800, 1200 RPM
- Enclosure: Totally Enclosed Fan Cooled (IP55)
- Voltage: 230/460V (Usable on 208V); 150HP and Larger is 460V Only
- 230/460V Motors Suitable for Partial Winding Start (at 230V Only)
- Three Phase, 60 Hz, 1.15 Service Factor (Continuous on Sine Wave Power)
- CSA Certified for Class I, Div. 2, Group B, C, D - Temp Code T3 Minimum
- Inverter Duty (PWM) per NEMA® MG-1 Part 31 at 1.0 Service Factor
- Dual Column (60/50 Hz) Design Nameplate as Standard; 50 Hz Data 190/380V at 1.0 S.F.
- Standard Features: Non-Sparking Ball Type NRR, Drip/Splash Cover, Space Heaters (120V)
- 5000 Frames and Above also include Mounting Provisions for bearing RTD's and Insulated Bearing Housing
- CSA Certified for Class I, Div. 2, Groups B, C, D; Temp Code T3 minimum
- Class F Insulation with Phenolic Alkyd Resin Varnish
- Class B Temperature Rise
- NEMA Design B Torques
- Oversized Main Conduit Box Rotatable in 90 Degree Increments - Fully Gasketed with NPT Threaded Entrance
- Cast Iron Conduit Box for F#449TP and Below; Steel Plate Conduit Box for F#5000
- Designed for 40°C Ambient Temperature¹
- Designed for 3300 ft. Elevation²
- Counterclockwise (CCW) Rotation; Viewed from Top
- Cast Iron Frame & End Brackets
- 1045 Solid Carbon Steel Shaft
- Aluminum Die Cast Squirrel Cage Rotor Construction
- Paint System: Phenolic Rust Proof Base Plus Polyurethane Top Coat
- Paint Color: Blue - Munsell 5PB 3/8
- Guide Bearings: 254VP - 286VP frames are Grease Pre-packed Double Shielded Bearings (MULTEMP SRL)
324VP - 5009VP frames are Re-Greasable (Mobil Polyrex EM)
- Thrust Bearings: 254VP - 286VP frames are Re-Greasable Angular Contact (Mobil Polyrex EM);
324VP - 449VP frames are Oil Lubricated Angular Contact; F#5000 and Above with Spherical Roller
- Oil Requirements for 324VP-405VP - 145 to 175 S.S.U. @100°F
- Oil Requirements for 444VP-5810VP - 300 S.S.U. @100°F
- Grounding Terminal Inside Main Box
- Stainless Steel Nameplate and Rodent Screens
- 12 Leads (PWS on 230V) on 254VP - 405VP;⁽³⁾
6 Leads on 444VP to 449VP; 5000 Frames and Above with Connection Studs⁽⁴⁾
- Suitable for Inverter Use per NEMA MG-1 Part 31.4.4.2
- 10:1 Variable Torque with NRR. 10:1 C.T., 20:1 VT without NRR Using Braking in VFD
- Precautions should be taken to eliminate or reduce shaft currents that may be imposed on the motor by VFD as stated per NEMA MG-1 Part 31

EXTRAS/ OPTIONS:

Please refer to pages 147 - 152 for common modifications that can be performed.

Notes:

1. Consult a Stock Product Application Specialist for suitability in higher ambient environments.
2. Consult a Stock Product Application Specialist for suitability at higher elevations.
3. Suitable for Wye/Delta start at 230V or 460V.
4. Suitable for Wye/Delta start at 460V.

MAX-VSP™ VERTICAL SOLID SHAFT TEFC



AEEHED (MAX-VSTP™) NEMA PREMIUM [VSTP]

Effective: 01-01-2022

LOW VOLTAGE

Supersedes: 07-06-2021



CATALOG NUMBER	HP	RPM	FRAME	FL EFF %	FL PF %	FL AMPS (460V)	DOWN THRUST (lbs.)	BD DIM (in.)	APPROX. SHIPPING WT. (lbs.)	LIST PRICE (\$)
VSTP0154	15	1800	254VP	92.4	88.0	17.3	3,350	10.0	350	8,392
VSTP0156	15	1200	284VP	92.4	83.5	16.4	3,850	10.0	460	10,534
VSTP0158	15	900	286VP	90.2	78.0	20.0	4,400	10.0	520	10,274
VSTP0204	20	1800	256VP	93.0	87.5	23.0	3,350	10.0	450	8,899
VSTP0206	20	1200	286VP	91.7	84.0	22.1	3,850	10.0	520	10,814
VSTP0208	20	900	324VP	91.0	81.0	25.4	6,000	16.5	700	12,956
VSTP0254	25	1800	284VP	93.6	86.0	29.1	3,350	10.0	520	10,534
VSTP0256	25	1200	324VP	93.0	83.0	26.9	5,200	16.5	700	14,407
VSTP0258	25	900	326VP	91.0	80.0	32.2	6,000	16.5	740	14,632
VSTP0304	30	1800	286VP	93.6	87.5	34.3	3,350	10.0	558	10,804
VSTP0306	30	1200	326VP	93.0	80.5	32.3	5,200	16.5	740	14,739
VSTP0308	30	900	364VP	93.0	78.0	38.7	7,500	16.5	900	17,896
VSTP0404	40	1800	324VP	94.1	86.0	46.3	4,500	16.5	720	14,409
VSTP0406	40	1200	364VP	94.1	86.5	42.3	6,600	16.5	900	16,682
VSTP0408	40	900	365VP	93.0	78.0	51.5	7,500	16.5	970	21,803
VSTP0504	50	1800	326VP	94.5	87.0	57.0	4,500	16.5	780	14,725
VSTP0506	50	1200	365VP	94.1	86.0	53.0	6,600	16.5	970	17,269
VSTP0508	50	900	404VP	93.0	81.0	62.0	10,500	16.5	1,400	27,069
VSTP0604	60	1800	364VP	95.0	86.5	68.4	6,000	16.5	900	16,679
VSTP0606	60	1200	404VP	94.5	87.0	63.0	9,000	16.5	1,400	28,456
VSTP0608	60	900	405VP	93.0	81.0	74.5	10,500	16.5	1,600	30,834
VSTP0754	75	1800	365VP	95.4	86.5	85.1	6,000	16.5	970	17,265
VSTP0756	75	1200	405VP	94.5	86.5	78.5	9,000	16.5	1,600	28,694
VSTP1004	100	1800	405VP	95.4	87.5	112	7,900	16.5	1,415	28,709
VSTP1006	100	1200	444VP	95.0	79.8	123	10,000	16.5	1,980	45,978
VSTP1254	125	1800	444VP	95.4	85.6	143	8,800	16.5	2,050	45,737
VSTP1256	125	1200	445VP	95.0	79.0	155	10,000	16.5	2,090	47,387
VSTP1504	150	1800	445VP	95.8	88.0	166	8,800	16.5	2,150	49,585
VSTP1506	150	1200	447VP	95.8	77.2	189	11,400	20.0	2,110	54,470
VSTP2004	200	1800	447VP	96.2	82.5	235	10,000	20.0	2,530	59,627
VSTP2006	200	1200	449VP	95.8	76.6	254	11,400	20.0	2,850	59,585
VSTP2504	250	1800	449VP	96.2	83.1	292	10,000	20.0	2,890	60,154
VSTP2506	250	1200	449VP	95.8	74.3	328	11,400	20.0	3,040	67,333
VSTP3004	300	1800	449VP	96.2	83.1	351	10,000	20.0	3,580	66,292
VSTP3006	300	1200	5009VP	95.8	84.8	345	12,300	24.5	3,880	89,185
VSTP3504	350	1800	5009VP	96.2	86.3	394	10,700	24.5	4,080	90,493
VSTP3506	350	1200	5808VP	95.8	80.6	424	20,200	30.0	5,800	130,611
VSTP4004	400	1800	5009VP	96.2	86.6	449	10,700	24.5	4,260	109,267
VSTP4006	400	1200	5808VP	95.8	80.9	482	20,200	30.0	6,040	132,991
VSTP4504	450	1800	5808VP	96.2	84.0	521	9,900	30.0	6,000	126,774
VSTP4506	450	1200	5808VP	95.8	80.2	547	20,200	30.0	6,250	136,554
VSTP5004	500	1800	5808VP	96.2	84.0	578	9,900	30.0	6,220	129,491
VSTP5006	500	1200	5808VP	95.8	81.2	601	20,200	30.0	6,770	144,236
VSTP6004	600	1800	5810VP	96.2	84.0	694	9,900	30.0	6,770	140,933
VSTP6006	600	1200	5810VP	95.8	81.7	717	20,200	30.0	7,260	156,355
VSTP7004	700	1800	5810VP	96.2	85.0	800	9,900	30.0	7,160	148,105
VSTP7006	700	1200	5810VP	95.8	81.3	840	20,200	30.0	8,830	164,205
VSTP8004	800	1800	5810VP	96.2	86.0	904	9,900	30.0	9,340	167,548

Notes:

1. Data subject to change without notice.
2. These specified ratings have larger shafts. Please make sure to check drawing and/or consult with the Applications Specialist for replacement motor. TWMC larger shaft dimensions for reference:
 447VP - U Dim=2.625" AH Dim=5.00"
 449VP - U Dim=2.625" AH Dim=5.00"
 5000VP - U Dim=2.875" AH Dim=5.00"
 5800VP - U Dim=3.750" AH Dim=8.50"

VERTICAL SOLID SHAFT WPI HIGH THRUST with "P" BASE - MEDIUM VOLTAGE



AMRKED, NEMA PREMIUM (200 HP - 1000 HP) [VSKP]

Effective: 01-01-2022
Supersedes: 07-06-2021

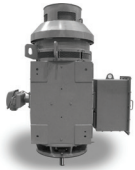

APPLICATIONS:

- Deep Well Turbine Pumps
- Irrigation
- Water/Wastewater

FEATURES:

- Output Range: 200 - 1000 HP
- Speed: 1800, 1200, 900 RPM
- Enclosure: Weather Protected Type I (WPI)
- Voltage: 2300/4000V
- Three Phase, 60 Hz, 1.15 Service Factor (Continuous on Sine Wave Power)
- Inverter Duty (PWM) per NEMA® MG-1 Part 31 at 1.0 Service Factor
- Standard Features: Ball Type NRR, Drip/Splash Cover, Space Heaters (120V)
- 5000 Frames and Above also include Mounting Provisions for bearing RTD's and Insulated Bearing Housing
- Class F Insulation with VPI Epoxy Resin Varnish
- Class B Temperature Rise
- NEMA Design B Torques
- Oversized Main Conduit Box Rotatable in 90 Degree Increments - Fully Gasketed with NPT
- Threaded Entrance
- Steel Plate Conduit Box for F#449-5800
- Designed for 40°C Ambient Temperature¹
- Designed for 3300 ft. Elevation²
- Counterclockwise (CCW) Rotation; Viewed from Top
- Cast Iron Frame & End Brackets
- 1045 Solid Carbon Steel Shaft
- Aluminum Die Cast Squirrel Cage Rotor Construction for F#449TP and Below 4pole; 6-8 pole copper fabricated rotor
- Squirrel Cage Copper or Copper Alloy Bar Rotor Construction for F#5000
- Paint System: Paint System Epoxy Base Coat Plus Polyurethane Top Cover
- Paint Color: Blue - Munsell 5PB 3/8
- Guide Bearings: 449VP - 5810VP Frames are Re-Greasable with Mobil Polyrex™ EM Grease
- Thrust Bearings: 449VP - 5810VP Frames are Oil Lubricated Angular Contact or Spherical Thrust Bearing with Site Glass
- Oil Requirements for 449VP - 5810VP Frames: 300 S.S.U. @ 100°F
- Grease Discharge Fittings on Frames with Re-Greasable Motors
- Metal Flinger on Lower End Bracket
- Grounding Terminal Inside Main Box
- Stainless Steel Nameplate
- Suitable for Inverter Use per NEMA MG-1 Part 31.4.4.2
- Speed Ranges: 10:1 VT, 4:1 CT
- 6 Leads
- UL Recognized and CSA Approved
- Precautions should be taken to eliminate or reduce shaft currents that may be imposed on the motor by VFD
- as stated per NEMA MG-1 Part 31.
- Ball Type NRR Provided

EXTRAS/ OPTIONS:

Please refer to pages 147 - 152 for common modifications that can be performed.

Notes:

1. Consult a Stock Product Application Specialist for suitability in higher ambient environments.
2. Consult a Stock Product Application Specialist for suitability at higher elevations.

VERTICAL SOLID SHAFT WPI HIGH THRUST with "P" BASE - MEDIUM VOLTAGE



AMRKED, PREMIUM EFFICIENCY [VSKP]

Effective: 01-01-2022
Supercedes: 07-06-2021

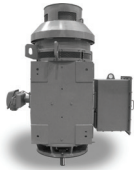

CATALOG NUMBER	HP	RPM	FRAME	FL EFF %	FL PF %	FL AMPS (4000V)	DOWN THRUST (lbs.)	BD DIM. (in.)	APPROX SHIPPING WT. (lbs.)	LIST PRICE (\$)
VSKP2006	200	1200	449VP	94.9	81.0	25.5	11,200	20.0	3,620	75,089
VSKP2008	200	900	5009VP	93.6	73.0	27.5	39,500	24.5	4,210	110,266
VSKP2504	250	1800	449VP	95.0	82.2	30.0	10,000	20.0	3,710	67,913
VSKP2506	250	1200	449VP	95.0	80.0	31.5	11,200	20.0	3,730	76,931
VSKP2508	250	900	5009VP	94.5	75.3	33.0	39,500	24.5	4,570	116,078
VSKP3004	300	1800	449VP	95.0	83.8	35.5	10,000	20.0	3,810	68,251
VSKP3006	300	1200	5009VP	95.0	77.6	38.0	33,800	24.5	4,230	107,453
VSKP3008	300	900	5808VP	95.0	77.0	38.5	39,200	30.0	5,520	142,250
VSKP3504	350	1800	5009VP	95.0	86.7	40.0	30,900	24.5	3,730	107,380
VSKP3506	350	1200	5009VP	95.0	75.9	45.5	33,800	24.5	4,110	109,021
VSKP3508	350	900	5808VP	93.6	78.0	45.0	39,200	30.0	5,770	145,522
VSKP4004	400	1800	5009VP	95.0	86.8	45.5	30,900	24.5	3,820	109,067
VSKP4006	400	1200	5009VP	95.0	75.6	52.0	33,800	24.5	4,190	110,266
VSKP4008	400	900	5810VP	93.6	78.0	51.5	38,600	30.0	6,160	152,941
VSKP4504	450	1800	5009VP	95.0	87.1	51.0	30,900	24.5	3,910	110,192
VSKP4506	450	1200	5806VP	95.0	80.2	55.5	33,600	30.0	4,630	116,266
VSKP5004	500	1800	5009VP	95.0	87.6	56.5	30,900	24.5	4,090	113,184
VSKP5006	500	1200	5806VP	95.0	80.2	61.5	33,600	30.0	4,730	143,695
VSKP6004	600	1800	5808VP	95.4	86.0	69.0	30,600	30.0	5,370	143,777
VSKP6006	600	1200	5808VP	95.0	80.3	73.5	33,300	30.0	5,180	148,969
VSKP7004	700	1800	5810VP	95.4	86.0	80.0	30,100	30.0	5,780	149,001
VSKP7006	700	1200	5808VP	95.0	81.2	85.0	33,300	30.0	5,460	152,724
VSKP8004	800	1800	5810VP	95.4	86.3	91.5	30,100	30.0	6,030	152,568
VSKP8006	800	1200	5810VP	95.0	80.7	97.5	33,000	30.0	5,850	158,225
VSKP9004	900	1800	5810VP	95.4	86.7	103	30,100	30.0	6,300	158,147
VSKP9006	900	1200	5810VP	95.0	81.5	109	33,000	30.0	6,090	158,564
VSKP10004	1000	1800	5810VP	95.4	87.3	113	30,100	30.0	6,650	158,483

Notes:

1. Data subject to change without notice.
2. TWMC larger shaft dimensions for reference:
447VP - U Dim=2.875" AH Dim=6.00"
449VP - U Dim=2.875" AH Dim=6.00"
5009VP - U Dim=3.375" AH Dim=6.00"

VERTICAL SOLID SHAFT TEFC HIGH THRUST with "P" BASE - MEDIUM VOLTAGE



AEHCED, PREMIUM EFFICIENCY (150 HP - 700 HP) [VSKTP]

Effective: 01-01-2022
Supercedes: 07-06-2021



APPLICATIONS:

- Deep Well Turbine Pumps
- Irrigation
- Water/Wastewater

FEATURES:

- Output Range: 200 - 700 HP
- Speed: 1800, 1200 RPM
- Enclosure: Totally Enclosed Fan Cooled (IP55)
- Voltage: 2300/4000V
- Three Phase, 60 Hz, 1.15 Service Factor (Continuous on Sine Wave Power)
- Inverter Duty (PWM) per NEMA® MG-1 Part 31 at 1.0 Service Factor
- Standard Features: Non-Sparking Ball Type NRR, Drip/Splash Cover, Space Heaters (120V)
- 5000 Frames and Above also include Mounting Provisions for bearing RTD's and Insulated Bearing Housing
- CSA Certified for Class I, Div. 2, Groups B, C, D; Temp Code T3 minimum
- Class F Insulation with VPI Epoxy Resin Varnish
- Class B Temperature Rise
- NEMA Design B Torques
- Fab Steel Plate Oversized Main Conduit Box Rotatable in 90 Degree Increments - Fully Gasketed with NPT Threaded Entrance.
- Steel Plate Conduit Box with Threaded Connection Opening(s)
- Designed for 40°C Ambient Temperature¹
- Designed for 3300 ft. Elevation²
- Oversized Angular Contact or Spherical Thrust Bearing Installed
- Counterclockwise (CCW) Rotation; Viewed from Top
- Cast Iron Frame & End Brackets; Steel Plate Fan Cover
- 1045 Solid Carbon Steel Shaft
- Aluminum Die Cast Squirrel Cage Rotor Construction for F#449VP and Below
- Squirrel Cage Copper or Copper Alloy Bar Rotor Construction for F#5000 and Above.
- Paint System: Phenolic Rust Proof Base Plus Polyurethane Top Coat
- Paint Color: Blue - Munsell 5PB 3/8
- Guide Bearings: Re-Greasable with Mobil Polyrex™ EM Grease
- Thrust Bearings: Oil Lubricated Angular Contact or Spherical Thrust bearing with Site Glass
- Oil Requirements: 300 S.S.U. @ 100F
- Automatic Grease Discharge Fittings on Frames with Re-Greasable Motors
- Metal Flinger on Both Ends for Frames 320VP & Up
- Grounding Terminal Inside Main Box
- Stainless Steel Nameplate
- Suitable for Inverter Use per NEMA MG-1 Part 31.4.4.2
- Speed Ranges: 10:1 VT, 4:1 CT
- 6 Leads
- UL Recognized and CSA Approved
- Precautions should be taken to eliminate or reduce shaft currents that may be imposed on the motor by VFD as stated per NEMA-MG-1 Part 31

EXTRAS/ OPTIONS:

Please refer to pages 147 - 152 for common modifications that can be performed.

Notes:

1. Consult a Stock Product Application Specialist for suitability in higher ambient environments.
2. Consult a Stock Product Application Specialist for suitability at higher elevations.

VERTICAL SOLID SHAFT TEFC HIGH THRUST with "P" BASE - MEDIUM VOLTAGE



AEHCED, NEMA PREMIUM [VSKTP]

Effective: 01-01-2022
Supercedes: 07-06-2021



CATALOG NUMBER	HP	RPM	FRAME	FL EFF %	FL PF %	FL AMPS (4000V)	DOWN THRUST (lbs.)	BD DIM. (in.)	APPROX SHIPPING WT. (lbs.)	LIST PRICE (\$)
VSKTP1506	150	1200	449VP	95.0	80.1	18.0	11,400	20.0	2,950	71,876
VSKTP2004	200	1800	449VP	95.0	82.9	23.5	10,000	20.0	2,830	72,043
VSKTP2006	200	1200	449VP	95.0	76.2	25.5	11,400	20.0	3,760	79,704
VSKTP2504	250	1800	449VP	95.0	83.7	29.0	10,000	20.0	3,920	73,170
VSKTP2506	250	1200	5009VP	95.0	81.9	30.0	12,100	24.5	4,040	102,942
VSKTP2508	250	900	5009VP	95.0	79.8	30.5	13,200	24.5	4,800	110,424
VSKTP3004	300	1800	5009VP	95.4	85.8	34.0	10,500	24.5	4,050	102,279
VSKTP3006	300	1200	5009VP	95.0	82.4	35.5	12,100	24.5	5,630	107,229
VSKTP3008	300	900	5009VP	95.0	77.3	38.0	24,300	24.5	6,440	138,135
VSKTP3504	350	1800	5009VP	95.4	86.1	39.5	10,500	24.5	5,420	105,512
VSKTP3506	350	1200	5808VP	95.2	80.4	42.5	22,300	30.0	6,060	137,458
VSKTP3508	350	900	5808VP	95.0	77.2	44.5	24,300	30.0	6,780	147,671
VSKTP4004	400	1800	5009VP	95.4	85.7	45.5	10,500	24.5	5,890	106,289
VSKTP4006	400	1200	5808VP	95.4	80.8	48.5	22,300	30.0	6,390	141,531
VSKTP4008	400	900	5808VP	95.0	77.3	50.5	24,300	30.0	7,120	154,941
VSKTP4504	450	1800	5808VP	95.4	83.8	52.5	9,700	30.0	6,300	139,096
VSKTP4506	450	1200	5808VP	95.6	80.9	54.0	22,300	30.0	6,680	145,783
VSKTP4508	450	900	5810VP	95.0	77.1	57.5	24,300	30.0	7,680	160,081
VSKTP5004	500	1800	5808VP	95.5	82.6	59.0	9,700	30.0	6,530	141,020
VSKTP5006	500	1200	5810VP	95.8	81.6	59.5	22,300	30.0	6,990	158,705
VSKTP5008	500	900	5810VP	95.4	76.8	63.5	24,300	30.0	7,890	168,693
VSKTP6004	600	1800	5810VP	95.7	84.3	69.5	9,700	30.0	6,900	152,520
VSKTP6006	600	1200	5810VP	96.0	81.3	71.5	22,300	30.0	9,110	160,727
VSKTP7004	700	1800	5810VP	95.9	84.6	80.5	9,700	30.0	8,950	159,871

Notes:

1. Data subject to change without notice.
2. TWMC larger shaft dimensions for reference:
 447VP - U Dim=2.625" AH Dim=5.00"
 449VP - U Dim=2.625" AH Dim=5.00"
 5000VP - U Dim=2.875" AH Dim=5.00"
 5800VP - U Dim=3.750" AH Dim=8.50"

C-FLANGE KITS FOR FIELD CONVERSION

Effective: 01-01-2022
Supersedes: 07-06-2021

NEMA C-FLANGE KITS FOR CAST IRON MOTORS							
FRAME	LIST PRICE (\$)	ODP ASHH CATALOG NO. "DHP"	⁽²⁾ MAX-PE™ AEHH8P CATALOG NO. "NP"	⁽²⁾ MAX-E1® AEHE, AEHH8N CATALOG NO. "E" or "EP"	MAX-E2® AEHH CATALOG NO. "HH"	MAX-E2/841® AEHH8B LIST PRICE (\$)	MAX-E2/841® AEHH8B CATALOG NO. "HB"
140T	125	~	CFN140T	CFE140T	CFHH140T	350	CFHB140T
180T	180	~	CFN180T	CFE180T	CFHH180T	465	CFHB180T
210T	325	~	CFN210T	CFE210T	CFHH210T	721	CFHB210T
250T	454	CFDH250T	CFN250T	CFE250T	CFHH250T	856	CFHB250T
280TS	529	CFDH280TS	CFN280TS	CFE280TS	CFHH280TS	1075	CFHB280TS
280T	529	CFDH280T	CFN280T	CFE280T	CFHH280T	1075	CFHB280T
320T or TS	775	CFDH320T/TS	CFN320T/TS(X)	CFE320T/TS(X)	CFHH320	1175	CFHB320
360TS	825	CFDH360TS	CFN360TS	CFE360TS	CFHH360TS	1289	CFHB360TS
360T	825	CFDH360T	CFN360T	CFE360T	CFHH360T	1289	CFHB360T
400TS	1025	CFDH400TS	CFN400TS	CFE400TS	CFHH400TS	1575	CFHB400TS
400T	1025	CFDH400T	CFN400T	CFE400T	CFHH400T	1789	CFHB400T
444/445TS	2150	CFDH444/5TS	CFN444/7TS	CFE444/5TS	CFHH444/5TS	3400	CFHB444/5TS
444/445T	2150	CFDH444/5T	CFN444/5T	CFE444/5T	CFHH444/5T	3705	CFHB444/5T
447/449TS	2550	CFDH447/9TS	CFN444/7TS	CFE447/9TS	CFHH447/9TS	3810	CFHB447/9TS
447/449T	2550	CFDH447/9T	CFN447/9T	CFE447/9T	CFHH447/9T	3950	CFHB447/9T
Hybrid 449TS	2650	~	~	CFE449TS-HYBRID	~	~	~
Hybrid 449T	2650	~	~	CFE449T-HYBRID	~	~	~

NEMA C-FLANGE KITS FOR ROLLED STEEL MOTORS				
FRAME	LIST PRICE (\$)	ROLLED STEEL ASGA/ ASGH ASGHPE CATALOG NO. "DS", "DSP" or "DTP"	3 PHASE ROLLED STEEL AEGHPE CATALOG NO. "GH"	3 PHASE ROLLED STEEL AEGH CATALOG NO. "GP"
56	103	CFDS56	CFG56S ³ CFG56L/140 ⁴	~
140T	103	CFDT140T	~	CFG56L/140
180T	103	CFDT180T	~	CFGP180
210T	189	CFDT210T	~	CFGP210
250T	189	CFDT250T	~	~
280TS	424	CFDT280TS	~	~
280T	424	CFDT280T	~	~

C-FACE KITS FOR LARGE TEFC FRAMES		
FRAME	LIST PRICE (\$)	MAX-E1® AEHE, AEHH8N, AEGH GK CATALOG NO. "E", "EP", "KG"
5007A	3600	CFE5007A
5009A	3600	CFE5009A
5009B/C	3600	CFE5009B/C
5011A	3850	CFE5011A
5011B/C	3850	CFE5011B/C
5808A	4300	CFE5808A
5808B/C	4300	CFE5808B/C
5810A	5350	CFE5810A
5810B/C	5350	CFE5810B/C

Notes:

- *1. For MAX-E2/841®, type AEHH8B (cat# ""HB"") motors, INPRO™ Bearing Isolator Seal is already included in the list price. INPRO™ Bearing Isolator Seal ships separately and will be added to order as an additional no cost line item.
- "TS" Flanges are for 2 pole motors only. "TS" C-flanges for 280TS - 405TS are interchangeable between MAX-E1® and MAX®-SE/PE. 444TS - 449TS C-flanges are NOT interchangeable.
- 56 Frame Only - Fits bearing sizes 6204ZZ
- 56 and 140T Frames - Fits bearing sizes 6205ZZ
- For frame sizes larger than 449T, please refer to an Application Specialist for availability.
- MAX-E1® type AEHH8N "hybrid" ratings are cat# EP3502 & EP3504.
- Flanges for F# 505UZ and 586/7UZ Crusher Duty ""CD"" , type AEHHGD motors must be quoted by an Application Specialist.

C-FLANGE KITS FOR FIELD CONVERSION

Effective: 01-01-2022
 Supersedes: 07-06-2021

C-FLANGE KITS FOR SINGLE PHASE HVAC MOTORS		
FRAME	LIST PRICE SGS39,BEGS19,BEGS39 (\$)	MAX-E1® AEHE, AEHH8N, AEHGK CATALOG NO. "E", "EP", "KG"
ODP		
48	90	CFSHVO48
56	90	CFSHVO56
56H	95	CFSHVO56H
140	95	CFSHVO140
180	103	CFSHVO180
210	189	CFSHVO210
TEFC		
48	90	CFSHVT48
56	90	CFSHVT56
56H	95	CFSHVT56H
140	95	CFSHVT140
180	103	CFSHVT180
210	189	CFSHVT210

IEC B14 "C-FLANGE" KITS		
FRAME	LIST PRICE (\$)	METRIC AESV3W CATALOG NO. "MP"
80	125	CFM80
90	135	CFM90
100	180	CFM100
112	195	CFM112
132	325	CFM132
160	454	CFM160

Note:

1. 56 and 56H Frame Flanges are not interchangeable.

NEMA C-FLANGE KITS FOR SINGLE PHASE FARM DUTY MOTORS		
FRAME	LIST PRICE (\$)	SINGLE PHASE FARM DUTY CATALOG NO. "S"
56	103	CF56
140T	125	CFN140T
180T	180	CFN180T
210T	325	CFN210T

D-FLANGE KITS FOR FIELD CONVERSION

Effective: 01-01-2022
Supersedes: 07-06-2021

NEMA D-FLANGE KITS FOR CAST IRON MOTORS							
FRAME	LIST PRICE (\$)	ODP ASHH CATALOG NO. "DHP"	MAX-PE™ AEHH8P CATALOG NO. "NP"	MAX-E1® AEHE, AEHH8N CATALOG NO. "E" or "EP"	MAX-E2® AEHH CATALOG NO. "HH"	MAX-E2/841® AEHH8B LIST PRICE (\$)	MAX-E2/841® AEHH8B CATALOG NO. "HB"
140T	299	~	DFN140T	DFE140T	DFHH140T	333	DFHB140T
180T	319	~	DFN180T	DFE180T	DFHH180T	446	DFHB180T
210T	~	~	~	~	~	~	~
250T	385	DFDH250T	DFN250T	DFE250T	DFHH250T	688	DFHB250T
280TS	550	DFDH280TS	FACTORY MOD ¹⁰	FACTORY MOD ¹⁰	DFHH280TS	1053	DFHB280TS
280T	570	DFDH280T	FACTORY MOD ¹⁰	FACTORY MOD ¹⁰	DFHH280T	1053	DFHB280T
320T or TS	875	DFDH320	DFN320T/TS(X)	DFE320T/TS(X)	DFHH320	1153	DFHB320
360TS	900	DFDH360TS	FACTORY MOD ¹⁰	FACTORY MOD ¹⁰	DFHH360TS	1247	DFHB360TS
360T	900	DFDH360T	FACTORY MOD ¹⁰	FACTORY MOD ¹⁰	DFHH360T	1247	DFHB360T
400TS	955	DFDH400TS	DFN400TS	DFE400TS	DFHH400TS	1548	DFHB400TS
400T	955	DFDH400T	DFN400T	DFE400T	DFHH400T	1758	DFHB400T
444/445TS	2695	DFDH444/5TS	DFN444/5TS	DFE444/5TS	DFHH444/5TS	3406	DFHB444/5TS
444/445T	2695	DFDH444/5T	DFN444/5T	DFE444/5T	DFHH444/5T	3718	DFHB444/5T
447/449TS	3250	DFDH447/9TS	DFN447/9TS	DFE447/9TS ⁶	DFHH447/9TS ⁶	3507	DFHB447/9TS ⁶
447/449T	3250	DFDH447/9T	DFN447/9T	DFE447/9T ⁶	DFHH447/9T ⁶	3819	DFHB447/9T ⁶

D-FLANGE KITS FOR LARGE TEFC FRAMES		
FRAME	LIST PRICE (\$)	MAX-E1® AEHE, AEHH8N, AEHGK CATALOG NO. "E", "EP", "KG"
5007A	3500	DFE5007A
5009A	3500	DFE5009A
5009B/C	3500	DFE5009B/C
5011A	3750	DFE5011A
5011B/C	3750	DFE5011B/C
5808A	5100	DFE5808A
5808B/C	5100	DFE5808B/C
5810A	6741	DFE5810A
5810B/C	6741	DFE5810B/C

D-FLANGE KITS FOR LARGE ODP		
5000A	3,500	DFDH5000A

*Above Part# for 2 Pole Only

IEC B5 "D-FLANGE" KITS			
FRAME	LIST PRICE (\$)	METRIC AESV3W CATALOG NO. "MP"	SPECIAL NOTE
80	299	DFM80	~
90	309	DFM90	~
100	319	DFM100	~
112	329	DFM112	~
132	350	DFM132	~
160	385	DFM160	~
180	550	DFM180	~
200	675	DFM200	~
225MA	750	DFM225-2P	2 Pole Only
225SC/225MC	750	DFM225-4/6P	4 & 6 Pole Only
250SA	955	DFM250-2P	2 Pole Only
250SC	955	DFM250-4/6P	4 & 6 Pole Only

Notes:

1. For MAX-E2/841®, type AEHH8B (cat# ""HB"") motors, INPRO™ Bearing Isolator Seal is already included in the list price. INPRO™ Bearing Isolator Seal ships separately and will be added to order as an additional no cost line item.
2. "TS" Flanges are for 2 pole motors only. "TS" c-flanges for 280TS-449TS are interchangeable between MAX-E1® and MAX®-SE/PE.
3. 56 Frame Only - Fits bearing sizes 6204ZZ
4. 56 and 140T Frames - Fits bearing sizes 6205ZZ
5. For frame sizes larger than 449T, please refer to the factory.
6. MAX-E1® type AEHH8N "hybrid" ratings are cat# EP3502 & EP3504. No Dflange is available at this time for Hybrid frames.
7. Flanges for F# 505UZ and 586/7UZ Crusher Duty "CD", type AEHHGD motors must be quoted by an Application Specialist.
8. Flanges for Large ODP motors above 5000 2P must be quoted by an Application Specialist.
9. TECO-Westinghouse is working towards a solution for hybrid frame D-Flanges in the future.
10. Factory Mod noted Flange part numbers can only be modified in-house and must use the M3D mod pricing on Page 147-152.

DRIP COVERS, PAINT, and STOCK REPLACEMENT PARTS

Effective: 01-01-2022
Supersedes: 07-06-2021

DRIP COVER/FAN COVER ASSEMBLIES				
FRAME	ROLLED STEEL CATALOG NUMBER	ROLLED STEEL LIST PRICE (\$)	CAST IRON CATALOG NUMBER	CAST IRON LIST PRICE (\$)
140T	RSDC140T	102.00	CIDC140T	312
180T	RSDC180T	135.00	CIDC180T	400
210T	RSDC210T	193.00	CIDC210T	455
250T/TS	RSDC250T	355.00	CIDC250T	624
280T/TS	RSDC280TS	442.00	CIDC280T	931
320T/TS	RSDC320T/TS(X)	574.00	CIDC320T/TS(X)	1235
360T/TS	RSDC360T	1413.00	CIDC360T	1965
400T/TS	RSDC400T	1833.00	CIDC400T	2045

Notes:

- 56 frame drip covers available as stock items. Contact the parts department for part number and quote.
- Drip covers available for 440T and above as made to order. Contact part department for quote.

AEROSOL TOUCH-UP SPRAY PAINT				
MOTOR TYPE	PAINT PART NUMBER	COLOR	PAINT #	LIST PRICE (\$)
MAX-E1® TEFC JP-JM LOW VOLTAGE ODP	5D98549H04	LIGHT GRAY	MUNSELL N5.0	77
MAX-E2® MAX-E2/841® METRIC IE3 MAX-VHP™ MAX-VSP™ SINGLE PHASE HVAC	5D98549H05	BLUE	MUNSELL 5PB 3/8	77
SINGLE PHASE FARM DUTY	5D98549H07	GREEN	MUNSELL 5G 4/4	77
TEXP TEFC OIL WELL PUMP	5D98549H08	DARK BLUE	MUNSELL 5PB 4.5/2	77
MAX-SE™ MAX-PE™ MAX-HT™ HIGH EFFICIENCY VERTICALS MEDIUM VOLTAGE	5D98549H03	DARK GRAY	MUNSELL 7.5B 3.5/0.5	77
PERMANENT MAGNET	5D98549H34	MEDIUM DARK GREEN	MUNSELL 10GY 5/12	77

Stock Replacement parts:

Contact TECO-Westinghouse for replacement part inquiries for stock product motors.

Email our stock product parts group at Tframeparts@tecowestinghouse.com or call 1-800-USE-TECO and select or ask to be connected with the Stock Product Parts Group.

Most commonly replaced motor parts are stocked in limited quantities. Replacement parts are also available on a made-to-order basis.

To confirm the proper part is identified and quoted, the motor's catalog number AND serial number must be provided at time of inquiry. Not all currently stocked parts may be interchangeable for earlier models. Replacement parts for older models may no longer be available.

P-BASES HIGH THRUST TEFC VERTICAL MOTORS (HOLLOW SHAFT AND SOLID SHAFT)							
FRAME	TYPE	BD	AK	BB	AJ	BF	PART NUMBER
180	Standard	9.85"	8.25"	0.20"	9.125"	0.44"	PBVH-180
210	Standard	10"	8.25"	0.20"	9.125"	0.44"	PBVH-210
250	Standard	10"	8.25"	0.20"	9.125"	0.44"	PBVH-250
280	Standard	10"	8.25"	0.20"	9.125"	0.44"	PBVH-280
	Alternate	12"	8.25"	0.25"	9.125"	0.44"	PBVH-280
320	Standard	16.5"	13.5"	0.25"	14.750"	0.69"	PBVH-320
360	Standard	16.5"	13.5"	0.25"	14.750"	0.69"	PBVH-360
400	Standard	16.5"	13.5"	0.25"	14.750"	0.69"	PBVH-400
400	Alternate	20"	13.5"	0.25"	14.750"	0.69"	PBVH-400

P-BASES HIGH THRUST TEFC VERTICAL MOTORS (HOLLOW SHAFT AND SOLID SHAFT)							
FRAME	TYPE	BD	AK	BB	AJ	BF	PART NUMBER
444/445	Standard	16.5"	13.5"	0.25"	14.75"	0.69"	PBVH-444/445
"445TP20/ 447/449"	Standard	20"	13.5"	0.25"	14.75"	0.69"	PBVH-447/449
	Alternate	16.5"	13.5"	0.25"	14.75"	0.69"	PBVH-447/449-16.5
	Alternate	24.5"	13.5"	0.25"	14.75"	0.69"	PBVH-447/449-24.5
	Standard	24.5"	13.5"	0.25"	14.75" 22"	0.69" 0.94"	PBVH-5000
5000	Alternate	20"	13.5"	0.25"	14.75"	0.69"	PBVH-5000-20
	Alternate	30.5"	22"	0.25"	26"	0.69" 0.94"	PBVH-5000-30.5
	Standard	30.5"	22"	0.25"	26"	0.81"	PBVH-5800
5800	Alternate	24.5"	13.5"	0.25"	14.75" 22"	0.81"	PBVH-5800-24
	Alternate	36"	26"	0.25"	32"	0.81"	PBVH-5800-36

P-BASES HIGH THRUST WPI VERTICAL MOTORS (HOLLOW SHAFT AND SOLID SHAFT)								
FRAME	TYPE	BD	AK	BB	AJ	BF	PART NUMBER	NOTE
210	Standard	10"	8.25"	0.22"	9.125"	0.44"	PBVH-210-10	~
250	Standard	10"	8.25"	0.25"	9.125"	0.44"	PBVH-250-10	AMRCED ONLY
	Standard	10"	8.25"	0.25"	9.125"	0.44"	PBVH-250-10	AMRCNH ONLY
	Alternate	12"	8.25"	0.25"	9.125"	0.44"	PBVH-250-12	AMRCNH ONLY
	Alternate	16.5"	13.5"	0.25"	14.750"	0.44"	PBVH-250-16.5	~
280	Standard	10"	8.25"	0.25"	14.750"	0.44"	PBVH-280-10	~
	Alternate	12"	8.25"	0.25"	14.750"	0.44"	PBVH-280-12	~
	Alternate	16.5"	13.5"	0.25"	14.750"	0.44"	PBVH-280-16.5	~
320	Alternate	12"	8.25"	0.25"	9.125"	0.44"	PBVH-320-12	~
	Standard	16.5"	13.5"	0.28"	14.750"	0.69"	PBVH-320-16.5	~
360	Alternate	16.5"	13.5"	0.28"	14.750"	0.69"	PBVH-360-16.5	~
400	Standard	16.5"	13.5"	0.28"	14.750"	0.69"	PBVH-400-16.5	~

Notes:

1. P-Bases require factory machine work prior to shipment/installation.
2. Consult a Stock Product Application Specialist or T-Frame parts for P-base price and availability.
3. P-Bases also available for MAX-PE, MAX-E1 and MAX-E2 for select ratings. Consult a Stock Product Application Specialist or T-frame parts for details.

P-BASES HIGH THRUST WPI VERTICAL MOTORS (HOLLOW SHAFT AND SOLID SHAFT)							
FRAME	TYPE	BD	AK	BB	AJ	BF	PART NUMBER
444/445	Standard	16.5"	13.5"	0.25"	14.75"	0.69"	PBVH-444/445-16.5
444/445 - WPI ONLY	Alternate	20"	13.5"	0.25"	14.75"	0.69"	PBVH-400-20
445TP20/447/449	Standard	20"	13.5"	0.25"	14.75"	0.69"	PBVH-447/449-20
	Alternate	16.5"	13.5"	0.25"	14.75"	0.69"	PBVH-447/449-16.5
	Alternate	24.5"	13.5"	0.25"	14.75"	0.69"	PBVH-447/449-24.5
5000	Alternate	20"	13.5"	0.25"	14.75"	0.69"	PBVH-5000-20
	Standard	24.5"	13.5"	0.25"	14.75" 22"	0.94"	PBVH-5000-24.5
	Alternate	30.5"	22"	0.25"	26"	0.81"	PBVH-5000-30.5
5800	Alternate	24.5"	13.5"	0.25"	14.75" 22"	0.94"	PBVH-5800-24.5
	Standard	30.5"	22"	0.25"	26"	0.81"	PBVH-5800-30.5
	Alternate	36"	26"	0.25"	32"	0.81"	PBVH-5800-36

Notes:

1. P-Bases require factory machine work prior to shipment/installation.
2. Consult a Stock Product Application Specialist or T-Frame parts for P-Base price and availability.
3. P-Bases also available for MAX-PE, MAX-E1 and MAX-E2 for select ratings. Consult a Stock Product Application Specialist or T-frame parts for details.

P-BASE KITS FOR NO-THRUST TEFC FRAMES					
FRAME	LIST PRICE AEHH8P, AEHH8PCF, AEUH8PDC (\$)	MAX-PE AEHH8P PART NO. "NP" or "NPV"	LIST PRICE AEHH8B, AEHH8BCF, AEUH8BDC (\$)	MAX-E2/841® AEHH8B PART NO. "HB" OR "HBV"	BD
250T	425	PBN250T	850	PBHB250T	10"
280T	M3P	FACTORY MOD ²	1150	PBHB280T/TS	16.5"
320T	M3P	FACTORY MOD ²	1275	PBHB320T/TS	16.5"
360T	M3P	FACTORY MOD ²	1375	PBHB360T	16.5"
400T	1050	PBN400T	1700	PBHB400T	16.5"
444/445T	2975	PBN444/5T	3745	PBHB444/445T	16.5"
447/449T	3575	PBN447/9T	~	~	20"

Notes:

1. For MAX-E2/841®, type AEHH8B (cat# "HB") motors, INPRO™ Bearing Isolator Seal is already included in the list price. INPRO™ Bearing Isolator Seal ships separately and will be added to order as an additional no cost line item.
2. Factory Mod noted Flange part numbers can only be modified in-house and must use the M3P mod pricing on Page 149-150.

FACTORY MODIFICATION PRICING

Effective: 01-01-2022
Supersedes: 07-06-2021

MODIFICATION LEAD TIME

1. TWMC standard lead time for all modifications is 10-12 working days. If shorter lead time is required, please contact TWMC. Expediting fees will apply. Additional 15% of purchase order total is standard.
2. Modification lead time does not include transit time.
3. Lead time is based upon availability of parts.
4. M2X, M8A, M8B, M10, M11, M14A, M16, M18, M21A, are the only modifications that can be done to our explosion-proof motors.
5. Explosion Proof motors modified in Round Rock, TX only.

MOD. NUMBER	DESCRIPTION	LIST PRICE (\$)										
		NEMA FRAME:	56-180T	210T	250T	280T	320T	360T	400T	440T	5000	5800 & UP
		METRIC FRAME:	90S, 90L, 112S, 112M	132S, 132M	160M, 160L	180M, 180L	200M, 200L	225S, 225M	250S, 250M	~	~	~
M1	Nameplate Change		105	105	105	105	105	105	105	105	105	105
M1A	Additional Nameplate		140	140	140	140	140	140	140	140	140	140
M1B	304 Stainless Steel Hardware		~	~	2,548	2,548	2,970	2,915	3,593	3,593	3,997	4,565
M2 ¹	Space Heater 120V		464	466	644	644	669	793	921	1,004	1,678	1,906
M2 ¹	Space Heater 240V		464	466	644	644	669	793	921	1,004	1,678	1,906
M2 ¹	Space Heater 240V @ 120V		~	~	~	~	~	~	~	1,004	1,678	1,906
M2A ¹	Space Heater w/ Auxiliary Box 120V		881	881	1,136	1,136	1,152	1,228	1,535	1,615	2,118	2,351
M2A ¹	Space Heater w/ Auxiliary Box 240V		881	881	1,136	1,136	1,152	1,228	1,535	1,615	2,118	2,351
M2A ¹	Space Heater w/ Auxiliary Box 240V @ 120V		~	~	~	~	~	~	~	1,615	2,118	2,351
M2X	Space Heater "Explosion Proof Motors Only" 120V		721	721	863	1,085	1,234	1,260	1,370	2,281	~	~
M2X	Space Heater "Explosion Proof Motors Only" 240V		721	721	863	1,085	1,234	1,260	1,370	2,281	~	~
M2X	Space Heater "Exp. Proof Motors Only" 240V @ 120V		~	~	~	~	~	~	~	2,281	~	~
M3C ²	Installation of C-Face		330	500	877	851	1,050	1,152	1,623	2,852	6,138	6,906
M3C841 ²	Installation of C-Face w/ INPRO™ Seal (MAX-E2/841® Only)		674	960	1,382	1,535	1,918	2,148	2,610	4,012	~	~
M3D ^{2,11,12}	Installation of D-Flange		406	515	515	745	905	1,152	1,623	2,852	6,138	6,906
M3D841 ^{2,11}	Installation of D-Flange w/ INPRO™ Seal (MAX-E2/841® Only)		674	~	1,382	1,535	1,918	2,148	2,610	4,122	~	~
M3P ²	Installation of P-Base		~	~	592	645	811	1,030	1,449	1,993	~	~
M4 ³	"Stator Winding RTD's, 100 Ohm Platinum (1/ Phase)"		890	1,016	1,080	1,080	1,228	1,386	1,398	1,398	1,779	1,779
M4Av	Stator Winding RTD's w/ Auxiliary Box (1/ Phase)		~	~	~	~	~	1,918	1,918	1,918	2,455	2,532
M4B ³	Stator Winding RTD's, 100 Ohm Platinum w/ Auxiliary Box (2/ Phase)		~	~	~	~	~	~	3,568	4,489	4,633	4,926
M5	Thermistors (1/ Phase)		614	922	922	922	1,228	1,228	1,228	1,228	1,535	1,535
M5A	Thermistors (1/ Phase) w/ Auxiliary Box		1,398	1,525	1,535	1,535	1,843	1,918	1,918	1,918	2,455	2,532
M6	Thermostats (1/ Phase)		559	724	724	724	852	852	889	889	962	962
M6A	Thermostats (1/ Phase) w/ Auxiliary Box		1,035	1,145	1,272	1,272	1,382	1,455	1,705	1,705	2,053	2,108
M7	Bearing RTD's, 100 Ohm Platinum Cable Type with Aux Box		~	~	~	~	~	~	5,507	5,507	5,507	5,507
M8	Bearing Conversion - Roller to Ball or Ball to Roller		~	~	~	~	~	3,630	4,813	6,302	10,760	11,585
M8A ⁴	Convert to Ceramic Ball Bearings		1,098	2,044	2,493	2,930	3,187	3,754	5,472	7,219	12,128	15,593
M8B ⁴	Convert to Insulated Bearings		924	1,039	1,815	1,878	1,878	2,459	3,646	4,295	6,063	7,797
M9 ¹²	Change Rotation		~	~	~	~	~	~	~	~	2,846	2,846
M10	Shorten Shaft to NEMA TS Dimensions ONLY; Does Not Require TWMC Drawing		2,270	2,403	2,740	3,010	3,350	3,483	3,960	4,433	4,917	4,917
M10A	Special Keyless 4140 Shaft Ext. for 440T Frames and Above; Any Special Shaft		~	~	~	~	~	~	~	QUOTE	QUOTE	QUOTE
M10B	Any Non NEMA Special Shaft Required; Non NEMA Dim. requires TWMC Drawing		~	~	~	QUOTE	QUOTE	QUOTE	QUOTE	QUOTE	QUOTE	QUOTE
M10C	Drill and Tap Shaft		477	550	660	750	925	925	1,100	1,320	QUOTE	QUOTE
M11	F1 to F2 Mounting Conversion		210	264	377	377	377	503	587	733	9,486	9,486
M11A	F1 to F2 or F3 Mounting Conversion AFHP/AFHH ONLY		~	~	~	~	~	~	~	~	4,743	4,743
M12	Supply Oversized Main Conduit Box		~	~	~	~	~	~	~	4,620	4,620	7,460
M12A	Supply Fully Loaded Main Conduit Box		~	~	~	~	~	~	~	25,480	25,480	25,480

FACTORY MODIFICATION PRICING

Effective: 01-01-2022
Supercedes: 07-06-2021

MODIFICATION LEAD TIME

MOD. NUMBER	DESCRIPTION	LIST PRICE (\$)										
		NEMA FRAME:	56-180T	210T	250T	280T	320T	360T	400T	440T	5000	5800 & UP
		METRIC FRAME:	90S, 90L, 112S, 112M	132S, 132M	160M, 160L	180M, 180L	200M, 200L	225S, 225M	250S, 250M	~	~	~
M13 ¹³	Stainless Steel Breather Drains	210	264	377	377	377	503	503	589	589	670	
M14	Tropicalization/ Fungus Protection	435	545	545	655	765	1,021	1,498	1,755	2,525	2,525	
M14A	Tropicalization/ Fungus Protection for Explosion Proof Motors ONLY	341	341	341	341	341	341	341	562	1,028	1,028	
M15	Provisions for Vertical Jack Screws	~	~	~	~	~	~	1,185	1,185	INCLUDED	INCLUDED	
M16	Alternate Grease	330	364	364	440	508	589	670	751	1,185	1,185	
M17	Chico Motor Leads	210	264	377	377	377	503	633	633	1,243	1,563	
M18A ⁵	Epoxy Paint Finish	838	838	1,152	1,152	1,152	1,152	1,152	1,152	1,535	2,805	
M18B	Fire Pump Red	838	838	1,152	1,152	1,152	1,152	1,152	1,152	1,535	2,805	
M19 ⁴	Shaft INPRO™ Seals	~	~	~	~	~	~	~	3,623	3,623	3,623	
M19A	Shaft INPRO™ Seals AFHP/AFHH ONLY	~	~	~	~	~	~	~	~	2,475	2,475	
M20 ⁵	Grounding Provisions on Frame	140	140	140	140	140	140.00	140	INCLUDED	INCLUDED	INCLUDED	
M21	Drip Cover (TEFC) Rolled Steel	347	404	578	962	1,213	1,386	2,195	~	~	~	
M21A	Drip Cover (TEFC) Cast Iron	572	771	922	1,116	1,451	1,861	2,617	~	~	~	
M22	Extend Leads - Connection Behind Conduit Box; Price Based on 4' Leads	733	770	788	953	990	1,078	1,503	1,595	2,145	2,237	
		+\$1/ft	+\$1/ft	+\$1/ft	+\$3.25/ft	+\$6.50/ft	+\$12.70/ft	+\$19/ft	+\$23/ft	+\$25/ft	+\$41/ft	
M23 ⁹	Supply Shaft Grounding Ring	803	913	965	1,242	1,242	1,334	1,489	2,017	2,567	3,135	
M23A ⁹	Supply Internal Shaft Grounding Ring	1,300	1,485	1,485	2,485	2,485	2,650	2,950	3,175	QUOTE	QUOTE	
M23B ^{9,10}	VHS Shaft Grounding Ring & Insulated Bearing for VFD Duty	~	~	~	~	~	~	3,037	4,869	4,869	6,288	
M23H	Supply Shaft Grounding Device	803	913	965	1,242	1,242	1,334	1,489	2,017	2,567	3,135	
M24 ⁴	"Provisions for Vibration Sensor Spot Face, Drill & Tap (1/4-20)"	~	~	~	~	~	~	1,283	1,283	1,283	1,283	
M24A ⁴	Provide and Install Vibration Sensor/ Transmitter Spec. (Does Not Include Cabling or Terminations)	~	~	~	~	~	QUOTE	QUOTE	QUOTE	QUOTE	QUOTE	
M24B ⁴	Provide our Standard METRIX # ST5484E-121-0714-00 Transmitter	~	~	~	~	~	3,250	3,354	3,587	4,154	5,600	
M25	Mill Off Motor Feet	1,632	1,676	1,768	1,856	2,038	2,310	2,764	3,216	3,750	QUOTE	
M26 ⁷	Inline Blower for 1000:1 Speed Range	508	681	951	1,109	1,756	1,860	2,044	6,999	12,249	17,499	
M26A	Provide Centrifugal (Scorpion Tail) Blower, motor, filter, and fab fan cover for 440 and above frames.	~	~	~	~	~	~	~	9,955	15,450	19,495	
M27A ⁷	Installation of Dynapar Encoder	2,573	2,573	2,678	2,783	3,019	3,019	3,281	3,615	6,825	8,138	
M27B ⁷	Installation of Other Encoder	QUOTE	QUOTE	QUOTE	QUOTE	QUOTE	QUOTE	QUOTE	QUOTE	QUOTE	QUOTE	
M28	"Vertical Shaft Down - Snap Ring	~	~	~	~	~	3,250	3,354	3,587	4,154	5,600	
M28A	Vertical Shaft Up - DE Lip Seal and Breather Drains in NDE Endframe	572	645	890	907	925	1,181	1,205	1,380	1,920	1,997	
M29 ⁸	Oil Mist Ready	360	360	360	490	490	490	490	820	1,040	1,040	
M31 ⁸	Convert to IP65 or IP66	489	682	795	795	935	1,092	1,219	1,462	QUOTE	QUOTE	
M32	Precision Balance	~	~	~	~	~	QUOTE	QUOTE	QUOTE	QUOTE	QUOTE	
M33	175% Thrust or more on VHS on 440 Frame 200-400 HP	~	~	~	~	~	~	~	QUOTE	QUOTE	QUOTE	
M34	Convert TEFC to TEAO	650	750	850	900	1,100	1,300	1,600	1,900	QUOTE	QUOTE	
M35	Terminal Block in Main Lead Box(14)	458	654	654	654	890	890	1,042	1,042	~	~	

Notes:

1. Double de List Price for 240V Space Heaters operated at 120V.
2. Price includes the flange.
3. Only one per phase is available for 360T frame and smaller.
4. Price is per bearing.
5. Not required for MAX-E2® or MAX-E2/841®.
6. ~
7. M8A or M8B Mod required as well from frames 440TS/T and Larger.
8. Must Start with IEEE841 motor. Must perform M17 Mod for IP65. Must perform M17 Mod, plus add extra sealant to end brackets for IP66. M29 MOD not available for 56 frame.
9. No Shaft Grounding Ring allowed in Div#2 Area.
10. Must start with "VPH" NEMA Premium Series.
11. Not available for Hybrid F# 449T/TS frames: EP3502, EP3504, HB3502, HB3504.
12. Excludes ASHA "P" and AMHGTK "PG" 2 POLE motors. Contact Application Specialist for quote.
13. If adding Stainless Steel Breather Drains for shaft up application see M28A.
14. Terminal Block Not Available for 56 Frame Motors.

FACTORY MODIFICATION DESCRIPTIONS

Effective: 01-01-2022
Supersedes: 07-06-2021

M1. Nameplate Change:

Add new nameplate displaying approved data changes such as new voltage and frequency, revised HP and service factor, higher or lower ambient temperature, etc. Information should be clearly stamped on P.O.

M1A. Additional Nameplate:

Add second data plate with customer part number, order number, or other data.

M1B. 304 Stainless Steel Hardware:

Add 304 Stainless Steel Hardware - Bolts, Nameplate.

M2. Space Heater:

Add wrap around space heaters with leads brought out to main terminal box.

Standard voltage is 120V, however other voltages are available. Please specify voltage when ordering. All heaters are single phase.

M2A. Space Heater w/ Auxiliary Box:

Same as M2, except an auxiliary terminal box is added to the side of the main terminal box and the space heater leads are brought out to the auxiliary terminal box.

M2X. Space Heater "Explosion Proof":

Add wrap around space heaters with leads brought out to main terminal box.

Standard voltage is 120V, however other voltages are available. Please specify voltages when ordering. All heaters are single phase.

This applies to TWMC's explosion proof line of motors.

M3C. Installation of C-Face:

Remove drive-end bracket and replace with C-Face: Modification Price includes the C-Face.

M3C841. Installation of C-Face w/ INPRO™ Seal (MAX-E2/841® only):

Remove drive-end bracket and replace with C-Face and INPRO™ Seal: Only Available on MAX-E2/841® Line.

M3D. Installation of D-Flange:

Remove drive-end bracket and replace with D-Flange: Modification Price includes the D-Flange.

M3D841. Installation of D-Flange w/ INPRO™ Seal (MAX-E2/841® only):

Remove drive-end bracket and replace with D-Flange and INPRO™ Seal: Only Available on MAX-E2/841® Line.

M3P. Installation of P Base on any Horizontal Motor for Vertical Mount.

Remove drive-end bracket and install P-base.

M4. Stator Winding RTDs, 100 Ohm Platinum (1/ phase):

Provide 100 Ohm platinum resistant temperature detectors (RTDs), one per phase, on the winding end turns with leads brought out to main terminal box. Note TWMC's medium voltage line of products come standard with 100 Ohm platinum RTD's, two per phase.

M4A. Stator Winding RTDs w/ Auxiliary Box (1/ Phase):

Provide 100 Ohm platinum resistant temperature detectors (RTDs) two per phase on the winding end turns with leads terminated in an auxiliary terminal box.

Note: On motors 449T frame and smaller, the auxiliary box will be located on the same side as the main lead box.

On 5000 frames and larger, the auxiliary box will be located on the F2 side, or on the opposite side of the main lead box.

M4B. Stator Winding RTDs, 100 Ohm Platinum w/ Auxiliary Box (2/ Phase):

Provide 100 Ohm platinum resistant temperature detectors (RTDs) one per phase on the winding end turns with leads terminated in an auxiliary terminal box.

Note: On motors 360T - 449T, the auxiliary box will be located on the same side as the main lead box.

On 5000 frames and larger, the auxiliary box will be located on the F2 side, or on the opposite side of the main lead box.

M5. Thermistors (1/ Phase):

Provide (3) PTC thermistors (140°C) on the winding end turns with leads brought out to main terminal box.

M5A. Thermistors (1/ Phase) w/ Auxiliary Box:

Provide (3) PTC thermistors (140°C) on the winding end turns with leads brought out to an auxiliary terminal box.

The auxiliary box will be located on the side of the main terminal box.

M6. Thermostats (1/ Phase):

Addition of (3) normally closed thermostats (140°C) to the winding end turns, connected in series with the leads brought out to the main terminal box. This is standard on Explosion Proof Motors.

M6A. Thermostats (1/ Phase) w/ Auxiliary Box:

Addition of (3) normally closed thermostats (140°C) to the winding end turns, connected in series with the leads brought out to an auxiliary terminal box. The auxiliary box will be located off the side of the main terminal box.

M7. Bearing RTD's, 100 Ohm Platinum Cable Type with Aux. Box (2/ Motor):

Add 100 Ohm platinum bearing resistance temperature detectors, on both the drive and non-drive end bearing.

Specify if alternate type is required.

FACTORY MODIFICATION DESCRIPTIONS

Effective: 01-01-2022
Supersedes: 07-06-2021

M8. Convert Bearings - Ball to Roller or Roller to Ball:

Convert from Roller Bearings to Ball Bearings or Ball Bearings to Roller Bearings.
The Roller to Ball conversion requires some machining on bearing caps to allow for thermal growth.

M8A. Convert to Ceramic Ball Bearings:

Convert to Ceramic Ball Bearings: Replace existing bearing(s) with Ceramic bearings, where the balls are ceramic.
This would reduce / eliminate shaft currents. TWMC's standard is on the Non-Drive End Bearing only.

M8B. Convert to Insulated Bearings:

Replace existing bearing(s) with bearings that have outer race coated with insulated material like SKF "Insocote."
This would be to reduce / eliminate shaft currents. TWMC's standard is on the Non-Drive End bearing only.

M9. Change Rotation:

This modification only applies to 2-Pole (3600/3000 RPM) motors in 5000 frames and larger. Standard direction of rotation is counter clockwise, facing the drive-end of the motor. This modification will change either the internal or external fans for operation in the clockwise direction, facing the drive-end.

M10. Shorten Shaft to NEMA TS Dimensions ONLY; Non-NEMA Dim Requires TWMC Drawing:

Machine shafts to TS Dimensions per NEMA MG1 ONLY. This does not include new bearings. This does NOT require a TWMC drawing.

M10A. Special Keyless 4140 Shaft Extension for 5000 Frames and above; Any Special Shaft:

Extension is for 5000 frames and above, where torsional stress in the application is high, such as reciprocating gas compressors.
Requires TWMC approval, quote, and drawing.

M10B. Any NON NEMA Special Shaft Required:

This requires a TWMC quote and Drawing.

M10C. Drill and Tap Shaft

M11. F1 to F2 Mounting Conversion:

Convert terminal box location from standard F1 to F2, or F2 to F1, depending on the product line. On medium voltage motors, the auxiliary terminal boxes will be on the opposite side of the main terminal box as standard.
If the requirement is to have all terminal boxes on either the F1 side or the F2 side, please specify.

M11A. F1 to F2 OR F3 Mounting Conversion:

Convert terminal box location from standard F1 to F2 OR F3, for the AFHP, MAX-MV E2 / 841 LITE or AFHH, Max-E1 motors 5000, 5800 & 6800 frames only. The auxiliary terminal boxes will be on the opposite side of the main terminal box as standard.
If the requirement is to have all terminal boxes on either the F1 side or the F2 side, please specify.

M12. Supply Oversized Main Conduit Box:

Replace existing conduit box with an oversized main conduit box. This would be done if the TWMC standard box does not meet customer's requirement. Mount and extend leads if necessary

M12A. Supply Fully Loaded Oversized Main Conduit Box:

Replace existing conduit box with a fully loaded box. The box will be TWMC standard size and will contain TWMC standard lightning arrestors, surge capacitors, and current transformers (50:5). Box is not self-supporting and will require the customer to support.

M13. Stainless Steel Breather Drains:

Drill and tap the existing drain holes to accommodate a Crouse-Hinds stainless steel breather drain.
Note, this is standard on MAX-E2®, MAX-E2/841® and Explosion Proof motors.

M14. Tropicalization/ Fungus Protection:

Involves disassembling the motor and spraying the internal windings.

M14A. Tropicalization/ Fungus Protection for Explosion Proof Motors ONLY:

Involves disassembling the motor and spraying the internal windings.

M15. Provisions for Vertical Jack Screws:

Drill and tap (2) holes per motor.

M16. Alternate Grease:

Purge and repack lubricant in end brackets with TWMC standard high temp. or low temp. grease. Please contact TWMC for alternates.

M17. Chico Motor Leads:

Apply a compound between terminal box and frame of motor. This feature is standard for explosion proof motors.

M18A. Epoxy Paint Finish:

Standard paint finish will be changed to Epoxy paint (e.g. MAX-E2® Epoxy Paint (Blue)).

M18B. Fire Pump Red Finish:

Standard paint finish will be changed to Fire Pump Red (e.g. PPG Pitt-Tech 90-306 Safety Red).
Also requires addition of UL nameplate and Renameplate to show "FP" in catalog number.

M19. Shaft INPRO™ Seals:

Add INPRO™ seals to drive-end only of MAX-E2® motors 140T~449T/TS frames.
This modification is only available for frames 440T and larger on all other product lines. The price reflects drive-end only.

FACTORY MODIFICATION DESCRIPTIONS

Effective: 01-01-2022
Supersedes: 07-06-2021

M19A. Shaft INPRO™ Seals:

Add INPRO™ seals to both ends of the AFHP, MAX-MV E2 / 841 LITE® or AFHH, Max-E1® motors 5000, 5800 & 6800 frames only. The price reflects both drive-end and non-drive-end.

M20. Grounding Provisions on Frame:

Drill and tap the motor frame. This is standard on MAX-E2®, MAX-E2/841®, Oil Well Pump motors, & motors on 5000 frames & larger. All motors have a grounding lug inside the main lead box as a standard.

M21A. Drip Cover (TEFC) Cast Iron:

Replace the existing fan cover with a cast iron drip cover. This is only for motors mounted vertically.

M22. Extend Leads - Connection Behind Conduit Box; Price Based on 4' leads:

Extend existing leads to the length specified by customer. The splice will be made behind the conduit box so it is not seen.

M23. Supply Shaft Grounding Ring:

Install AEGIS shaft grounding ring as made by ELECTRO STATIC TECHNOLOGY. CSA Hazardous Location nameplates must be removed. This would be to reduce or eliminate shaft currents. For other methods of shaft grounding, please contact TWMC.

M23A. Vertical Hollow Shaft Grounding Ring:

Install a Shaft Grounding Ring internally on inboard side of Guide Bearing Cap.

M23B. VHS and VSS Shaft Grounding Ring & Insulated Brg. For VFD Duty:

Must start with a VHS/VSS NEMA Premium motor. Install a SGR internally on guide bearing inboard cap, and insulated bearing.

M23H. Supply Shaft Grounding Device:

Install Helwig Carbon shaft grounding carbon brush as made by Helwig Carbon. CSA Hazardous Location nameplates must be removed. This would be to reduce or eliminate shaft currents. For other methods of shaft grounding, please contact TWMC.

M24. Provisions for Vibration Sensor:

Drill, tap and machine end bracket(s) to accommodate vibration sensor. Customer is required to submit specifications of vibration sensor. Price is per bracket.

M24A. Provide and Install Vibration Sensor (Does Not Include Cabling or Terminations):

Drill, tap and machine end bracket(s) to accommodate vibration sensor. TWMC standard switch will be provided as made by METRIX, ROBERTSHAW, PREDICTECH, or STI.

For details or pricing to provide another brand, please contact TWMC. Price is per bracket.

M24B. Provide our Standard METRIX # ST5484E-121-714-00 Vibration Switch

M25. Mill Off Motor Feet:

TWMC will cut off the feet of a footed motor to create a round body type motor. Second lifting lug available for an additional price adder.

M26. Inline Blower for 1000:1 Speed Range:

Remove existing fan and fan cover and replace with TWMC standard inline blower/ fan cover configuration. Blower motor will require a separate power source. Modification will also require an "M8A" modification for 440TS/T frames & larger.

M26A. Installation of Centrifugal Blower:

Provide Centrifugal Blower, motor, filter, and fan cover for 440 and above frames.

M27A. Installation of Dynapar Encoder:

Install TWMC standard Encoder as made by Dynapar.

M27B. Installation of Other Encoder:

Please contact factory for quote.

M28. Snap Ring for Mounting the Motor Vertical Shaft Down

Available on 320 frames and up, only for motors with roller bearings.

M28A. Install Drive End Lip Seal and Stainless Steel Breather Drains for Motor Vertical Shaft Up

To prevent moisture from entering the motor in shaft up applications in an outdoor environment.

M29. Oil Mist Ready:

TWMC to prepare motors for immediate Oil Mist Lubrication, includes M17 MOD Chico Leads. Must use MAX-E2/841® if applicable.

M31. Convert to IP65 or IP66:

TWMC to take IEEE 841 motor, perform M17 modification for IP65. Must perform M17 modification, plus add extra sealant to end-brackets, for conversion to IP66.

M32. Precision Balancing for Vibration limits below what standard NEMA specification on IEEE/841 motors.

M33. 175% Thrust VHS on 440 Frame 200-400 HP:

Modify the motor adding correct bearings, parts, and oil for higher thrust.

M34. Convert TEFC to TEAO

M35. Terminal Block in Main Lead Box:

Add a 6 lug terminal block into the the Cast Iron or Rolled Steel Main Lead Box for Motor Frame sizes 143T thru 449T and attach the motorleads to the terminal block.

MODIFICATION DRAWING REQUIREMENTS

Effective: 01-01-2022
Supersedes: 07-06-2021

DRAWING REQUIREMENTS

X No Drawing ● Basic Drawing ■ Modification Drawing

DRAWING REQUIRED	MOD CODE	MODIFICATION DESCRIPTION
X	M1	Nameplate Change
X	M1A	Additional Nameplate
X	M1B	304 Stainless Steel Hardware
●	M2	Space Heater
■	M2A	Space Heater with Aux Box
●	M2X	Space Heater "Explosion Proof Motors Only"
■	M3C	Installation of C-Face
■	M3C841	C-Face with Inpro (MAX-E2/841® only)
■	M3D	Installation of D-Flange
■	M3D841	D-Flange with Inpro (MAX-E2/841® only)
■	M3P	Installation of P-Base
X	M4	Winding RTD's 100 Ohm Platinum (1/Phase)
■	M4A	Winding RTD (2/Phase) with Auxiliary Terminal Box
●	M4B	Stator Winding RTDs, 100 Ohm Platinum (2/phase)
X	M5	Thermistors (1/Phase)
■	M5A	Thermistors (1/Phase) with Auxilliary Box
X	M6	Thermostats (1/Phase)
■	M6A	Thermostats (1/Phase) with Auxilliary Box
■	M7	Bearing RTD
●	M8	Bearings Conversion: Ball to Roller/ Roller to Ball
●	M8A	Convert to Ceramic Ball Bearings
●	M8B	Convert to Insulated Bearings
X	M9	Change Rotation
●	M10	Shorten Shaft (TS Frames) Per NEMA MG-1 Dimension (Non NEMA Dimensions Require TWMC Drawing and Approval)
■	M10A	Special Keyless 4140 Shaft Extension for 440 frames and Larger
■	M10B	Any Non NEMA Special Shaft Required; Non NEMA Dim Requires TWMC Drawing
■	M10C	Drill and Tap Motor Feet
X	M11	F1 to F2 Mounting Conversion
■	M12	Oversized Main Conduit Box - Mount and Extend Leads
■	M12A	Fully Loaded Main Conduit Box - Mount and Extend Leads
X	M13	Stainless Steel Breather Drains
X	M14	Tropicalization / Fungus Protection
●	M15	Provisions for Vertical Jack Screws
X	M16	Alternate Grease
X	M17	Chico Motor Leads
X	M18A	Epoxy Paint Finish
X	M18B	Fire Pump Red Finish
●	M19	Install INPRO Seals
■	M20	Grounding Provisions on Frame
●	M21	Drip cover (TEFC)- Rolled Steel
●	M21A	Drip cover (TEFC)- Cast Iron
X	M22	Extend Leads -Connect Behind Box; Price Based on 4' Leads
X	M23	Supply Shaft Grounding Ring
X	M23A	VHS Shaft Grounding Ring
X	M23B	VHS Shaft Grounding Ring & Insulated Brg for INV Duty
■	M23H	VHS Shaft Grounding Device
■	M24	Provision for Vibration Sensor
■	M24A	Provide and Install Vibration Switch/ Transmitter Spec. (Does not Include Cabling or Terminations)
■	M24B	Provide our Standard METRIX # ST5484E-121-714-00 Vibration Switch
■	M25	Mill Off Motor Feet
■	M26	Inline Blower for 1000:1 speed range
■	M26A	Install Centrifugal Blower
■	M27A	Installation Of Dynapar Encoder
■	M27B	Installation Of Other Encoder
X	M28	Snap Ring For Vertical Shaft Down
■	M28A	Vertical Shaft up DE lip seal and breather drains in NDE endframe
■	M29	Oil Mist Ready
X	M31	Convert to IP56 or IP65
X	M32	Precision Balance
■	M33	175% Thrust or more on VHS on 440 Frame 200-400 HP
■	M34	Convert TEFC to TEAO
X	M35	Terminal Block in Main Lead Box

DIMENSIONS - AC MACHINES

Dimensions for Foot-Mounted Machines with a Single Straight-Shaft Extension

Effective: 01-01-2022
Supersedes: 07-06-2021

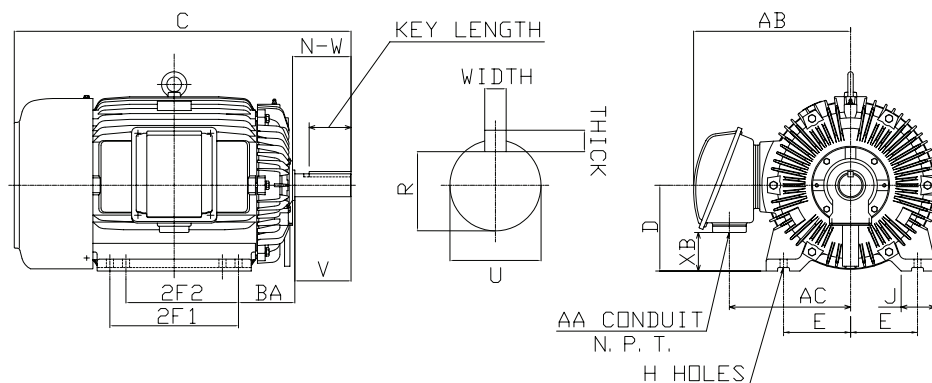

FRAME SIZE	MOUNTING							SHAFT EXTENSION			KEY & KEYSEAT				TERMINAL HOUSING			
	C	D	E	2F1	2F2	H	BA	N-W	U	V	WIDTH	THICK	LENGTH	R	AA	AB	AC	XB
143T	12.47	3.5	2.75	4	—	0.34	2.25	2.25	0.875	2.2	0.188	0.188	1.41	0.771	0.75	6.18	4.92	2.52
145T	13.46	3.5	2.75	5	4	0.34	2.25	2.25	0.875	2.2	0.188	0.188	1.41	0.771	0.75	6.18	4.92	2.52
182T	14.77	4.5	3.75	4.5	—	0.41	2.75	2.75	1.125	2.7	0.25	0.25	1.78	0.986	0.75	7.44	6.06	3.36
184T	15.79	4.5	3.75	5.5	4.5	0.41	2.75	2.75	1.125	2.7	0.25	0.25	1.78	0.986	0.75	7.44	6.06	3.36
213T	18.09	5.25	4.25	5.5	—	0.41	3.5	3.38	1.375	3.3	0.312	0.312	2.41	1.201	1	8.86	7.07	3.32
215T	19.59	5.25	4.25	7	5.5	0.41	3.5	3.38	1.375	3.3	0.312	0.312	2.41	1.201	1	8.86	7.07	3.32
254T	23.7	6.25	5	8.25	—	0.53	4.25	4	1.625	3.9	0.375	0.375	2.91	1.416	1.25	10.24	8.58	4.37
256T	25.44	6.25	5	10	8.25	0.53	4.25	4	1.625	3.9	0.375	0.375	2.91	1.416	1.25	10.24	8.58	4.37
284T	26.8	7	5.5	9.5	—	0.53	4.75	4.62	1.875	4.5	0.5	0.5	3.28	1.591	1.25	12.13	9.84	3.97
284TS	25.43	7	5.5	9.5	—	0.53	4.75	3.25	1.625	3.2	0.375	0.375	1.93	1.416	1.25	12.13	9.84	3.97
286T	28.3	7	5.5	11	9.5	0.53	4.75	4.62	1.875	4.5	0.5	0.5	3.28	1.591	1.25	12.13	9.84	3.97
286TS	26.93	7	5.5	11	9.5	0.53	4.75	3.25	1.625	3.2	0.375	0.375	1.93	1.416	1.25	12.13	9.84	3.97
324T	29.93	8	6.25	10.5	—	0.66	5.25	5.25	2.125	5.15	0.5	0.5	3.91	1.845	2	13.47	10.98	3.59
324TS	28.43	8	6.25	10.5	—	0.66	5.25	3.75	1.875	3.65	0.5	0.5	2.03	1.591	2	13.47	10.98	3.59
326T	31.42	8	6.25	12	10.5	0.66	5.25	5.25	2.125	5.15	0.5	0.5	3.91	1.845	2	13.47	10.98	3.59
326TS	29.92	8	6.25	12	10.5	0.66	5.25	3.75	1.875	3.65	0.5	0.5	2.03	1.591	2	13.47	10.98	3.59
364T	32.57	9	7	11.25	—	0.66	5.88	5.88	2.375	5.75	0.625	0.625	4.28	2.021	3	15.1	12.28	2.39
364TS	30.44	9	7	11.25	—	0.66	5.88	3.75	1.875	3.65	0.5	0.5	2.03	1.591	3	15.1	12.28	2.39
365T	33.55	9	7	12.25	11.25	0.66	5.88	5.88	2.375	5.75	0.625	0.625	4.28	2.021	3	15.1	12.28	2.39
365TS	31.42	9	7	12.25	11.25	0.66	5.88	3.75	1.875	3.65	0.5	0.5	2.03	1.591	3	15.1	12.28	2.39
404T	36.5	10	8	12.25	—	0.81	6.62	7.25	2.875	7.15	0.75	0.75	5.65	2.45	3	19.07	14.33	1.81
405T	37.99	10	8	13.75	12.25	0.81	6.62	7.25	2.875	7.15	0.75	0.75	5.65	2.45	3	19.07	14.33	1.81
405TS	34.99	10	8	13.75	12.25	0.81	6.62	4.25	2.125	4.15	0.5	0.5	2.78	1.845	3	19.07	14.33	1.81
444T	44.4	11	9	14.5	—	0.81	7.5	8.5	3.375	8	0.875	0.875	6.89	2.88	3	24	17.9	2.4
444TS	40.65	11	9	14.5	—	0.81	7.5	4.75	2.375	4.5	0.625	0.625	3.03	2.021	3	24	17.9	2.4
445T	46.4	11	9	16.5	14.5	0.81	7.5	8.5	3.375	8	0.875	0.875	6.89	2.88	3	24	17.9	2.4
445TS	42.65	11	9	16.5	14.5	0.81	7.5	4.75	2.375	4.5	0.625	0.625	3.03	2.021	3	24	17.9	2.4
447T	49.9	11	9	20	16.5	0.81	7.5	8.5	3.375	8	0.875	0.875	6.91	2.88	3	24	17.9	2.4
447TZ	51.12	11	9	20	16.5	0.81	7.5	10.12	3.375	9.62	0.875	0.875	8.5	2.88	3	24	17.9	2.4
447TS	46.15	11	9	20	16.5	0.81	7.5	4.75	2.375	4.5	0.625	0.625	3.03	2.021	3	24	17.9	2.4
449T	54.9	11	9	25	20	0.81	7.5	8.5	3.375	8	0.875	0.875	6.91	2.88	3	24	17.9	2.4
449TZ	56.12	11	9	25	20	0.81	7.5	10.12	3.375	9.62	0.875	0.875	8.5	2.88	3	24	17.9	2.4
449TS	51.15	11	9	25	20	0.81	7.5	4.75	2.375	4.5	0.625	0.625	3.03	2.021	3	24	17.9	2.4

All dimensions are in inches and for reference only.

DIMENSIONS - AC MACHINES

Effective: 01-01-2022
 Supersedes: 07-06-2021

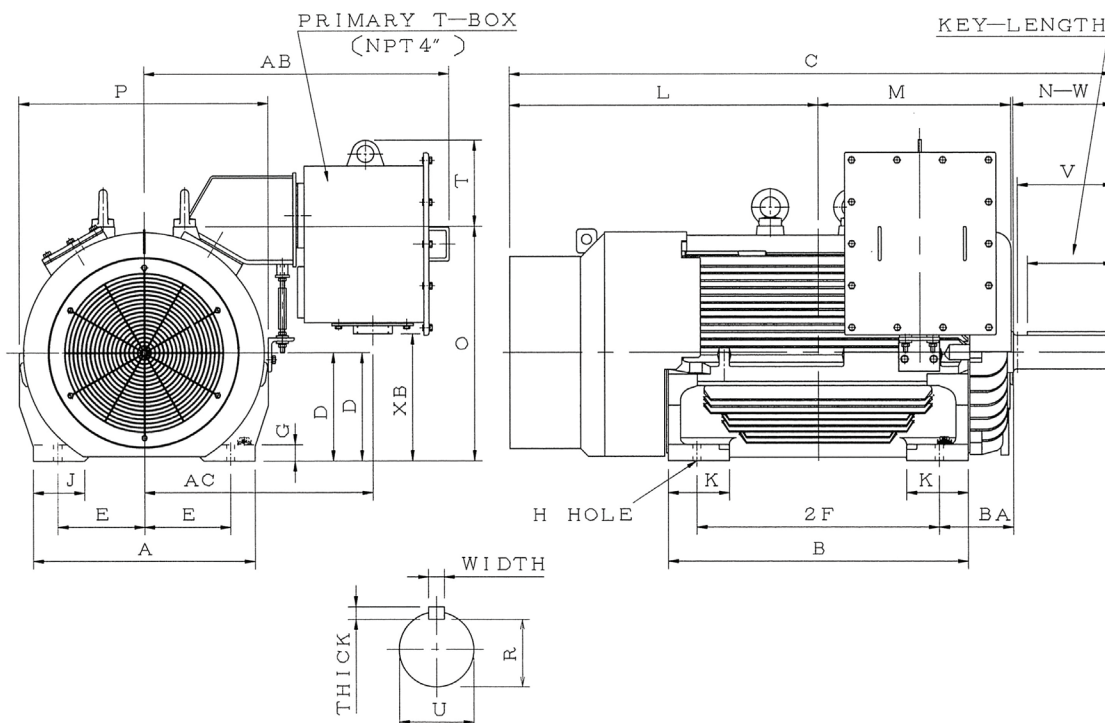

FRAME SIZE	MOUNTING						SHAFT EXTENSION			KEY & KEYSEAT				TERMINAL HOUSING				
	C	D	E	2F	H	BA	N-W	U	V	WIDTH	THICK	LENGTH	R	AA	AB	AC	XB ^{E1}	XB ^{CD}
505UZ	53.04	12.5	10.00	18.00	0.94	8.50	11.62	3.875	11.38	1.000	1.000	10.000	3.309	4	32.5	23.6		4.75
5007A	63.25	12.5	10.00	22.00	0.94	8.50	5.75	2.625	5.50	0.625	0.625	4.010	2.275	4	35.50	26.40	14.70	
5007B,C	63.80	12.5	10.00	22.00	0.94	8.50	11.62	3.875	11.12	1.000	1.000	10.000	3.309	4	35.50	26.40	14.70	2.75
5009A	69.20	12.5	10.00	28.00	0.94	8.50	5.75	2.625	5.50	0.625	0.625	4.010	2.275	4	35.50	26.40	14.70	
5009B,C	69.75	12.5	10.00	28.00	0.94	8.50	11.62	3.875	11.12	1.000	1.000	10.000	3.309	4	35.50	26.40	14.70	2.75
5011A	77.15	12.5	10.00	36.00	0.94	8.50	5.75	2.625	5.50	0.625	0.625	4.010	2.275	4	35.50	26.40	14.70	
5011B,C	77.67	12.5	10.00	36.00	0.94	8.50	11.62	3.875	11.12	1.000	1.000	10.000	3.309	4	35.50	26.40	14.70	
586/7UZ	64.37	14.5	11.50	22.00	1.125	10.00	11.625	4.375	11.125	1.000	1.000	8.661	3.816	2-3	29.33	23.23		2.96
5808B,C	74.08	14.5	11.50	28.00	1.13	10.00	11.88	4.875	11.38	1.250	1.250	10.000	4.169	2-3	37.85	28.95	19.00	2.95
5810A	81.40	14.5	11.50	36.00	1.13	10.00	5.75	2.625	5.50	0.625	0.625	4.010	2.275	2-3	37.85	28.95	19.00	2.95
5810B,C	81.81	14.5	11.50	36.00	1.13	10.00	11.88	4.875	11.38	1.250	1.250	10.000	4.169	2-3	37.85	28.95	19.00	2.95
6808A	88.43	17.0	13.50	36.00	1.38	11.50	5.75	2.625	5.50	0.625	0.625	4.010	2.275	2-3	40.30	31.40	23.80	
6808B,C	87.68	17.0	13.50	36.00	1.38	11.50	11.88	4.875	11.38	1.250	1.250	10.000	4.169	2-3	40.30	31.40	23.80	2.95

All dimensions are in inches and for reference only.

(E1) Denotes the MAX-E1® and MAX-E2® frame construction.

(CD) Denotes the MAX-HT™ frame construction.

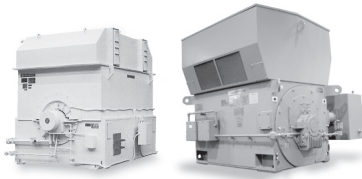

WORLD SERIES® MOTORS: SETTING THE STANDARD OF EXCELLENCE

Building on over 100 years of Westinghouse motor experience, TECO-Westinghouse World Series® motors represent the induction motor at its highest state of evolution. We began with a product known for excellence, and through computer-aided design and the use of advanced materials, made it even better. We have made it leaner, more efficient, and highly refined. Yet the World Series® line of motors retains all the original quality features that established Westinghouse as the world leader among large motor manufacturers – features such as rugged copper bar rotor construction, Thermalastic® insulation, and heavy-duty frame construction.

At TECO-Westinghouse Motor Company, we pride ourselves on service. As our customer, you can tap the strength of our resources for superior front-end services, including engineering support, computer-aided engineering studies, product information and quotation assistance. Once your World Series® Motor is in place, you can rely on our worldwide field service and engineering network to service and protect your investment.

World Series® motors offer a full range of benefits to fill your large induction motor requirements. For more information, contact your local TECO-Westinghouse representative, or call us direct at our Round Rock, Texas headquarters: 1-800-451-8798.

WORLD SERIES® VERTICAL MOTORS FOR HIGH-THRUST CONDITIONS

A long and successful history with vertical motor construction goes into the making of every vertical motor in the World Series® line.

Used primarily for pump applications, World Series® vertical motors are designed to handle virtually any thrust load that might be imposed (loads well in excess of 100,000 lbs., continuous downward thrust). High-thrust load capability is achieved by utilizing Kingsbury-type tilting-pad thrust bearings. Both sleeve and ball bearings are available for guide bearings, depending on the application.

For long wear and reliability, the thrust bearings and guide bearings are air-cooled through constant ventilation and are oil lubricated from a large reservoir. Special water-cooling coils can also be added when needed.

World Series® vertical motors reflect the same high quality construction and insulation processes that distinguish all the various components of our horizontal motors. Our vertical motors are readily adaptable to a variety of specific needs. For example, non-reverse ratchets are available and flywheels can be included in the design when required. Our vertical motors can also be started from zero-speed or reverse-speed and can be designed to accommodate overspeed situations, as in a hydro-generator.

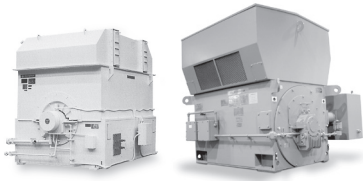

QUALITY FEATURES AND TIME-TESTED PERFORMANCE

- Copper rotor bars provide high conductivity and outstanding reliability.
- High frequency induction brazing ensures uniform end ring connections.
- Swaging contributes to long motor life by minimizing rotor bar movement.
- Rugged frame construction ensures lateral and torsional stability.
- Innovative PAM motors provide two-speed operation with only one winding.
- Thermalastic® insulation provides excellent protection from environmental contaminants.
- 250 HP to 30,000 HP ranges available for a wide variety of applications.
- High operating efficiency yields low life cycle cost.
- Split-sleeve bearings offer outstanding service and are easy to inspect.
- Adjustable frequency capability is available when specified.
- Each motor is custom designed for the most demanding applications.
- Over 100 years of experience goes into every motor we produce.

AVAILABLE ENCLOSURES

World Series® motors are offered in a complete range of enclosures to meet the toughest demands of any industry. IEC enclosures are also supplied. Available NEMA enclosures include the following configurations:

- Open Drip-Proof (Guarded), IP22/ IC01
- Weather Protected Type I, IP23/ IC01
- Weather Protected Type II, IPW24/ IC01
- Totally Enclosed Water-to-Air Cooled, IP44-54/ ICW81
- Totally Enclosed Air-to-Air Cooled, IP44-54/ IC411
- Totally Enclosed Pipe Ventilated, IP44/ IC31/ 37

TERMINAL BOXES

World Series® motors feature main lead and auxiliary terminal boxes constructed of 12-gauge steel. Each terminal box is gasketed for air-tight, dust-free, and weather-proof protection of terminal leads. Available for F1 or F2 locations, terminal boxes can be modified to include any customer terminations and accessory devices.

The main lead terminal box provides termination of the motor's main power leads. Available terminal box options include lightning arresters, surge capacitors, current transformers, special grounding devices, cable or bus bar terminations, and top or bottom lead entry.

WORLD SERIES® AIR CABINETS DESIGN LIST

Effective: 01-01-2022
Supersedes: 07-06-2021

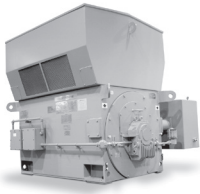

REPLACEMENT WPII AIR CABINETS FOR AGING TECO-WESTINGHOUSE AND WESTINGHOUSE MOTORS

Features and Benefits:

- Replacements for corroded air cabinets on aged motors
- Meets NEMA MG 1 requirements for WPI and WPII enclosures
- Tested to MIL-STD-810E for water-tightness
- Split-hinge design (Fig-2): for inlets, allowing for fast and safe filter replacement without the use of hand tools
Filter replacement possible without motor shutdown.
- Air cabinet changeout achievable onsite without motor removal.
- Minimal differences in overall dimensions between old and new design. Example shown below for frame 3509; actual dimensions will vary with frame size.

Standard Construction:

- A36 carbon steel – 11 gauge
- Full acoustic lining
- #4 Mesh stainless steel screens
- Stainless steel filters included.

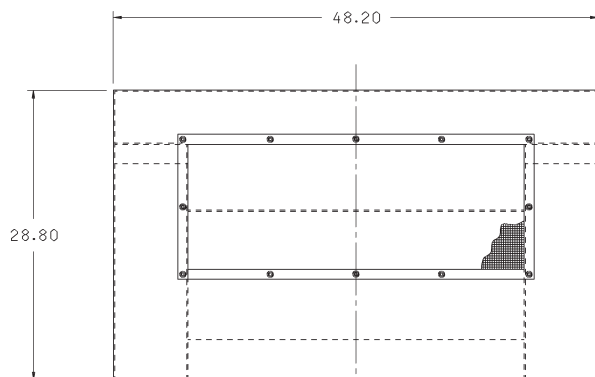

FIGURE 1
WORLD SERIES® DESIGN

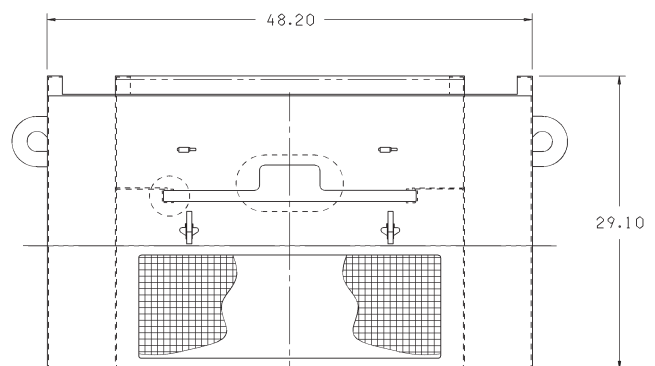
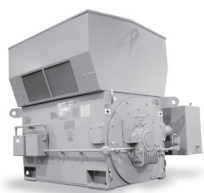

FIGURE 2
UNIVERSAL DESIGN

WORLD SERIES® AIR CABINETS DESIGN LIST

Effective: 01-01-2022
 Supersedes: 07-06-2021



WORLD SERIES® FRAME SIZE	UNIVERSAL AIR CABINET PART NUMBER
3505	2563F39G04
3506	2563F39G08
3507	2563F39G12
3508	2563F39G16
3509	2563F39G20
3510	2563F39G24
4008	2563F40G04
4009	2563F40G08
4010	2563F40G12
4011	2563F40G16
4509	2563F41G04
4510	2563F41G08
4511	2563F41G12
4512	2563F41G16
5010	2563F42G04
5011	2563F42G08
5012	2563F42G12
5014	2563F42G16
5611	2563F43G04
5612	2563F43G08
5614	2563F43G12
5616	2563F43G16

WORLD SERIES® FRAME SIZE	UNIVERSAL AIR CABINET PN
6312	6D47635G04
6314	6D47635G08
6316	6D47635G12
6318	6D47635G16
7112	6D45158G04
7114	6D45158G08
7116	6D45158G12
7118	6D45158G16
8014	2565F19G04
8016	2565F19G08
8018	2565F19G12
8020	2565F19G16
9016	2573F69G04
9018	2573F69G08
9020	2573F69G12
9022	2573F69G16

Available Options:

- All stainless steel construction
- Differential pressure devices
- Manometers
- Air temperature devices
- Mufflers
- Heat shield

NOTE:

Universal air cabinets are also available for Westinghouse Buffalo Life Line® D Series and TECO-Westinghouse Round Rock Life Line® D Series. For information, contact the Renewal Parts team at (888) 754-5006 or visit our website at www.tecowestinghouse.com.

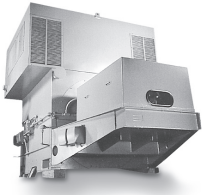

SYNCHRONOUS MACHINES: THE OPTIMAL CHOICE OF HEAVY INDUSTRY

TECO-Westinghouse Motor Company synchronous motors and generators provide superior value in terms of proven reliability, low maintenance performance, and long life in arduous applications. Our synchronous machines offer numerous benefits, including:

- Constant-speed operation
- High-efficiency ratings
- Low inrush currents
- Leading power factor (for corrective kVA capability)
- Horsepower range from 1000 HP to 100,000 HP

For more information, contact your local TECO-Westinghouse representative, or call us direct at our Round Rock, Texas headquarters: 1-800-451-8798.

PROVEN FEATURES FOR EFFICIENT SYNCHRONOUS MOTOR PERFORMANCE

TECO-Westinghouse Motor Company synchronous machines feature high efficiency designs in which great care is taken to minimize losses. To ensure maximum operating efficiencies and trouble free operations, the following features are standard on these motors:

- Airgap, slot openings, and slot ratios are selected to reduce pole face losses due to flux pulsations.
- Low loss, core-plated, non-aging, silicon steel stator punchings are used to reduce core losses.
- The stator copper is stranded to minimize eddy current losses.
- The number of stator slots, slot width, slot depth, and stator core depths are dimensioned to reduce magnetic noise.
- Pole punchings are designed for reduced pole leakage flux and field excitation to minimize field copper losses.
- Blowers are carefully selected to reduce windage loss.
- Stator end-plates are designed to ensure a tight and rigid core assembly, to minimize noise due to core distortion, and to transmit torque to the frame bulkhead.

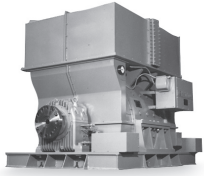

DC MOTOR APPLICATIONS

TECO-Westinghouse Motor Company DC motors are ideally suited to a multitude of industrial and marine applications in which high torque and variable speed are required. These applications include ship propulsion, mine hoists, and steel rolling mills. They also drive many other types of industrial equipment such as fans, Banbury mixers, and extruders.

To meet the needs of a broad range of applications, our rugged DC motors are available in sizes ranging from 22-inch to 12-foot armature diameters, with available power ratings from 250 HP to over 35,000 HP.

For more information, contact your local TECO-Westinghouse representative, or call us direct at our Round Rock, Texas headquarters: 1-800-451-8798.

CUSTOM DESIGNS AS A STANDARD FEATURE

TECO-Westinghouse Motor Company DC motors are designed and built for long life and minimum maintenance. Over 100 years of motor industry experience has yielded design features that add up to precision, performance, and reliability.

Our DC motors and generators are custom engineered to meet your specified needs. We can incorporate existing foundations, space limitations, service conditions, and enhanced sparing capabilities into our motor and generator designs. In addition, you can apply TECO-Westinghouse DC machines to any quality brand of controls with total confidence.

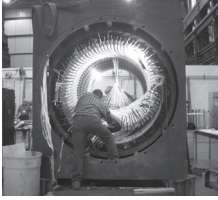

LARGE MOTOR REPAIR

At TECO-Westinghouse, size or complexity are never an issue. With a 200 ton lifting capacity and 90 feet under hook, TWMC can handle almost any large motor repair. Our service team, backed by a full staff of motor design and manufacturing engineers, can perform for you! Our range of services extends from basic motor maintenance to complete redesigns and rebuilds. Each repair is customized to meet your needs and work is performed via a carefully controlled process dictated by industry standards as well as to your specifications. At TWMC, we don't just put your motor back together the way we found it, we use sound engineering judgment, extensive manufacturing and design experience, and the same ISO 9001 quality system incorporated into new motor manufacturing, to ensure that the machine will perform as originally designed, if not better.

Each motor is carefully disassembled and rigorously inspected for mechanical or electrical issues, with digital photographs taken during the process. A full battery of non-destructive electrical tests are performed, and a detailed inspection report is generated and supplied for your review alongwith recommendations for repairs and improvements. Recommendations are often made for improvements tothe machine from an operational or reliability viewpoint. Upon authorization to proceed, a detailed "project control plan" is developed by one of our service engineers advising of the work to be done and specifying the parts to be used in the repairs or modifications. All work is performed by factory trained technicians with years of experience in both motor repair and in manufacturing the quality machines that the Westinghouseand TECO-Westinghouse names have come to represent.

Our asset reliability based **Quick Turn Rewind (QTR)** initiative is the leading repair service for large MV and HVmotors. These engineered rewinds are performed on all manufacturers motors around the clock to our ISO 9001 quality system with deliveries that meet or exceed customer expectations. Utilizing our in-house coil manufacturing and 12-foot VPI tank, TWMC's proven long life Thermalastic® epoxy insulation system, developed by Westinghouse for reliability.

If the motor repair or engineered component opportunity exceed your experience, expertise, or capacity, give TECO-Westinghouse a call. We pay finder's fees for all referrals that result in an order. Payments are made 45 days after completion and invoicing of the repair.

ORDER SIZE (\$)	FINDERS FEES (%)	MAXIMUM PAYOUT (\$)
≤ 99k	8	7,920
100k - 299k	6	17,940
300k - 499k	5	24,950
≥ 500k	3	50,000

FIELD SERVICE/ FACTORY TECHNICAL SUPPORT

The Service and Repair Group has you covered from the time the motor leaves our state of the art manufacturing facility. Our highly qualified staff of Field Service Engineers is ready to be dispatched throughout the world to support all of your field needs, and our Technical Support Staff is equipped to answer your questions, with the additional backing of our Design Center engineering personnel. Whether it be start-up and commissioning, preventative/ predictive maintenance, testing, installation and removal assistance, troubleshooting, consulting services, alignments, vibration analysis, dynamic balancing, turnkey projects or training, only our engineers are at the ready to tackle your most challenging needs.

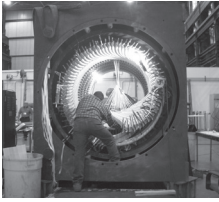

RENEWAL PARTS AND ENGINEERED COMPONENTS

TECO-Westinghouse Motor Company supplies genuine OEM replacement parts for large Westinghouse/TECO-Westinghouse AC and DC motors manufactured from 1900 to present. If you have any vintage or large Westinghouse motor in your plant, odds are that we have all the design and manufacturing data for your motor and can supply any part you may need, from nuts and bolts, to a complete drop in spare armature, rotor, or stator. Have an ongoing operation or maintenance concern? Let us know about it! Many older components can be, or have been, analyzed and redesigned for improved performance and maintainability. Need a large component for a non-Westinghouse machine? We may be able to design a drop in replacement.

ENGINEERING STUDIES

Would you like to get more horsepower out of your existing motor? Curious if it can be driven by a VFD? Have a nagging maintenance problem that just won't go away? Through an engineering study, we can research these and other questions, and provide you with viable solutions and answers. With our full complement of skilled design and manufacturing engineers, we can perform a broad spectrum of analyses and offer a complete solution that you won't find elsewhere!

3D MODELING & FINITE ELEMENT ANALYSIS

Using the most up to date tools, we can perform complete electrical, magnetic, thermal, and mechanical analyses. Our fully staffed Design and R&D Centers have the expertise to analyze and review the most complex motor designs.

FAILURE ANALYSIS

Want to avoid recurring failures and improve reliability? Complete motor failure analysis can be performed and root cause often determined for many types of electrical and mechanical motor problems. TWMC is fully equipped to gather the facts, perform diagnostic or material testing, review results for design, manufacturing or operational issues, and provide a detailed written report of findings.

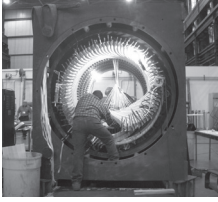

Refurbishing/ Retrofitting Control Wheels

Before

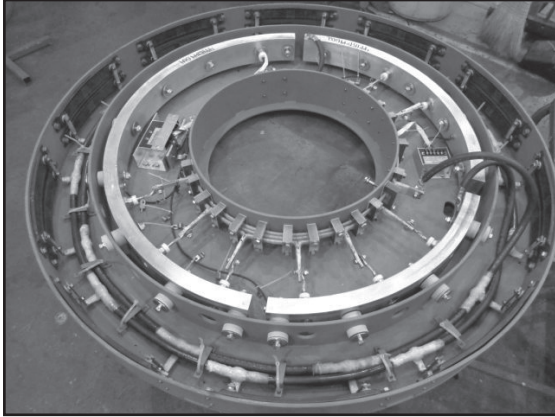

All new components, heat sinks, conductors, insulators, fasteners, lugs, etc. built on a mock-up wheel

After

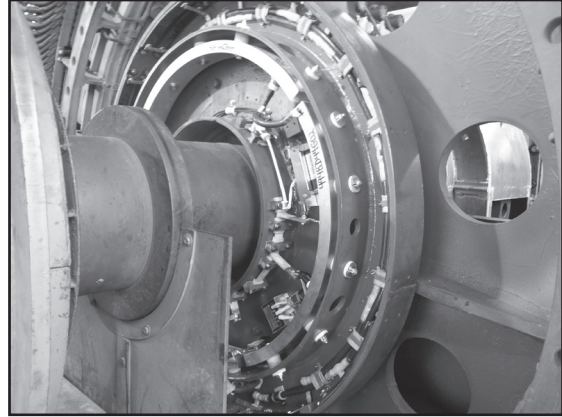

Everything on the mock-up transferred to the existing control wheel chassis

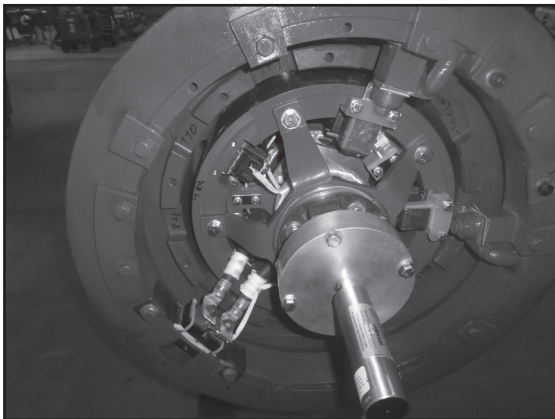

A TECO-Westinghouse control wheel customized to fit onto another OEM motor

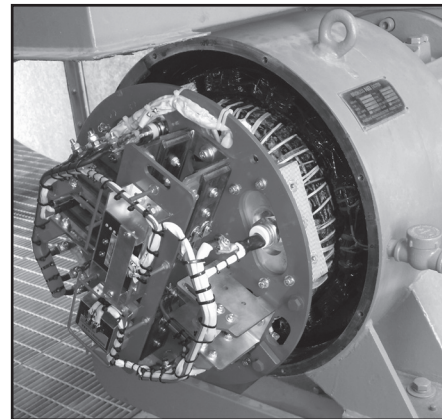

A TECO-Westinghouse control wheel customized to fit onto another OEM motor

Brushless Control Wheel Replacements and Retrofits

- Convert other OEM unsupported control wheels to a TWMC design
- On-site troubleshooting, repairs, and rebuilds
- In stock renewal parts

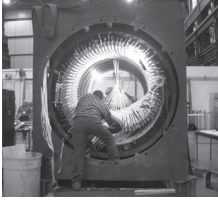

Exciter Control Panel Upgrades

Before

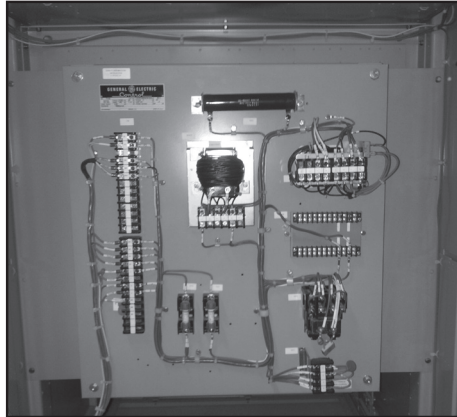

An analog, manual only, exciter control panel

After

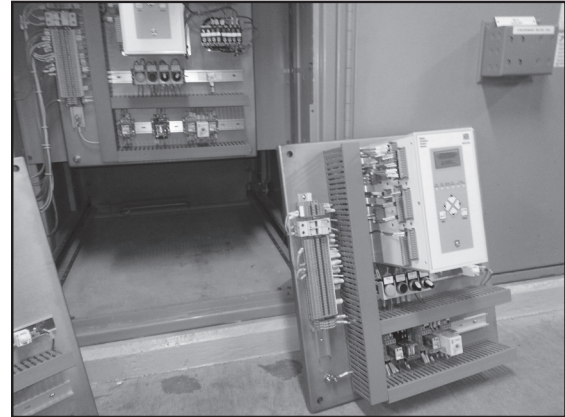

The same panel space fitted with a new digital exciter and power factor controller

Before

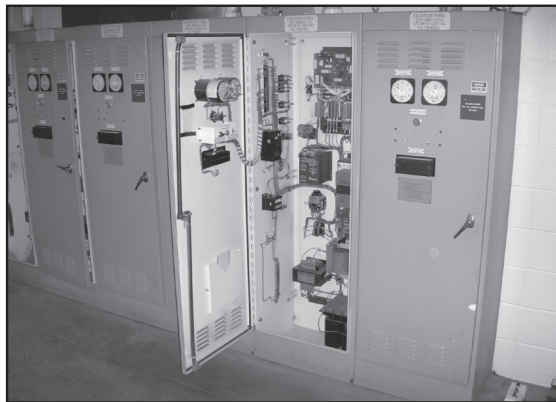

A typical '80s analog exciter control panel crowded with obsolete components

After



The same line-up with only a few components remaining

Exciter Control Panel Upgrades

- Replace outdated Analog Controls with a modern Digital System using the same panel space
- Superior control and accuracy of Voltage, VAR, and Power Factor Regulation
- Enhanced system response
- Advanced motor protection
- Reliable system operation

SERVICE - PREDICTIVE MAINTENANCE

Effective: 01-01-2022
Supersedes: 07-06-2021

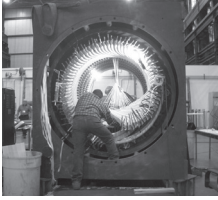

Caught off guard by unforeseen equipment failures? Identify costly repairs in advance and avoid unplanned forced outages with a TECO-Westinghouse predictive maintenance program. Our team of factory engineers and field service technicians make implementing and managing a condition based maintenance program easy and cost effective.

TECO-WESTINGHOUSE PREDICTIVE MAINTENANCE PROGRAM

- Vibration route setup, data collection and analysis
- Offline electrical testing of motors and drives
- Online testing and analysis of motors and drives
- Thermography survey and analysis
- Oil sample collection and analysis

BENEFITS OF A PREDICTIVE MAINTENANCE PROGRAM

- Improved uptime and reliability
- Efficient utilization of labor resources
- Increased human and environmental safety
- Reduced inventory costs
- Enhanced outage planning
- Increased product quality and customer satisfaction

TECO-WESTINGHOUSE FIELD SERVICES

- Start-up and commissioning services for motors and drives
- Troubleshooting and repairs for motors and drives
- Turn-key projects: remove, repair/replace, reinstall
- Vibration, operation deflection shape, and modal analysis
- Balancing
- Laser alignment
- Borescope inspection
- Filter inspection and maintenance
- Synchronous exciter control panel & diode control wheel rebuild/ retrofits
- Digital Pulse-Syn Module upgrades
- Factory technical support and training

For 24/7 service response, call us at 888-754-5006.

VB-100 SMART VIBRATION METER

Effective: 01-01-2022
 Supercedes: 07-06-2021

The new VB-100 smart vibration meter is a next generation device in Motor Health Management that combines a vibration sensor and display screen. It provides single-axis vibration RMS values and complete vibration measurement that customers can monitor on site and in real time. For motors equipped with VB-100, there's no need to connect additional gateways, mobile phones or perform complicated procedures of the management platform. By simply pushing a button or scanning the device's QR code, the motor vibration RMS value and health status can be obtained on the spot and in real time. Please consult the factory for pricing and future models suitable for hazardous environments.



KEY FEATURES

- Vibration data measurement and display as velocity RMS (mm/s)
- Dual-digit, 7-Segment LED Display
- Display velocity RMS range 0.1mm/s ~ 99mm/s
- Data collected per ISO-10816 vibration measurement specification.
- Easy push button provided to instantly display the vibration velocity RMS for the first 10 seconds and the health index for another 10 seconds.
- Vibration measurement, smart display: ⁽¹⁾ RMS vibration value; ⁽²⁾ Alarm (LED flashing); ⁽³⁾ Vibration health index (H1~H9, H9 means the healthiest)
- Battery powered, press button to start. No power cord, no signal wire. Battery capacity can be displayed at least 1000 times.
- Replaceable battery design (Panasonic CR2)
- Ultra-small in size: suitable for all motors of with frames 132~250
- Wire-free installation method: Adhesive
- Housing material: PC
- 2 models available:
 - VB-100B (flat bottom) is suitable for frame 160
 - VB-100C (flat bottom) is suitable for frames 180~250

SPECIFICATIONS

Product Name	VB-100
Vibration (velocity) measurement range	0~99 mm/s
Sensitivity error	5%(max) @100Hz
Frequency response	10~1000 Hz for ISO10816
Temperature error range	±0.01%/°C
Nonlinearity	±0.2%
Cross-axis sensitivity	±1.0% typical, ±3.5% max
Working temperature	Body: -40 ~85 °C Battery: -40 ~70 °C (Panasonic CR2)
Shock limit	20000g
Noise	70µg/√Hz
Output	2 digit LED, (RMS)

Data and dimensions subject to change. Consult factory for details.

DIMENSION

VB-100B/VB-100C
 59 x 29 x 22.3m m

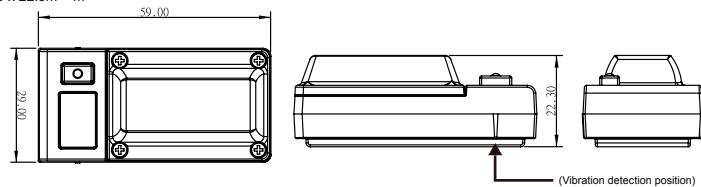

VB-100A
 59 x 31 x 22.3m m

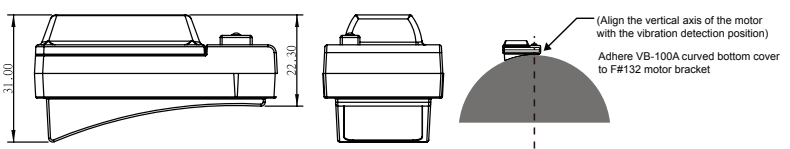

Health Index Feature

Health Index Feature

1. While the motor is operating, users can press the button beside the LCD of VB-100 to read the real-time motor vibration velocity value and health index.
2. Scan the QR Code on the battery cover for more information about health index of the motor.
3. The vibration health index is divided into 9 levels and the information is as shown below:

Health Index QR Code



Vibration Health Index		Suggestions
Normal	H9	Good to use
	H8	Check again in 6 months
	H7	Check again in 3 months
	H6	Check again in 2 months
Mild Abnormality	H5	Check again in 1 months
	H4	Check again in weekly
Moderate abnormal	H3	Shut down and check
	H2	Shut down and check
Critical	H1	Immediately Shut down and check

USEFUL FORMULAS

Effective: 01-01-2022
 Supersedes: 07-06-2021

kW	=	HP * .746
Torque in lb-ft	=	$\frac{HP * 5250}{RPM}$
Motor synchronous speed in RPM	=	$\frac{120 * Hz}{\text{Number of Poles}}$
Three-Phase Full-Load Amp	=	$\frac{HP * .746}{1.73 * kV * \left(\frac{\text{Efficiency}}{100}\right) * \left(\frac{\text{Power Factor}}{100}\right)}$
Rated Motor kVA	=	$\frac{HP * .746}{\text{Efficiency} * \text{Power Factor}}$
kW Loss	=	$\frac{(HP * .746) * (1.0 - \text{Efficiency})}{\text{Efficiency}}$
Wk ² Referred to Motor Shaft Speed	=	[Driven Machine Wk ² (Driven Machine RPM/ Motor RPM) ²]+ Gear Wk ² at Motor Speed
Accelerating Time	=	$\frac{0.462 (\text{Wk}^2 \text{ of Motor and Load}) \text{ RPM}^2}{\text{Motor Rated kW} * 104 * \text{Per-Unit Effective Accelerating Torque}}$
kVA inrush	=	Percent Inrush * Rated kVA
Approximate Voltage Drop (%)	=	$\frac{\text{Motor kVA Inrush}}{\text{Transformer kVA}} * \text{Transformer Impedance (Normally 5\% to 7\%)}$
Stored Kinetic Energy in kW-sec	=	2.31 * (Total Wk ²) * RPM ² x 10 ⁻⁷
Inertia Constant (H) in Seconds	=	$\frac{\text{Stored Kinetic Energy in kW Seconds}}{HP * .746}$
Conversion Factors:		
CV	=	(Metric HP) = 735.5 Watts = 75 KW-m/sec
Wk ² (lb-ft)	=	5.93 x GD ² (kg-m ²)

Derating motor for change in elevation: For each 330 foot increase in elevation above 3300 feet above sea level, derate motor horsepower by 1 percent.
 Cooling-water requirements: 2 gpm of water for each kW of loss.
 Ventilating-air requirements: 100-125 cfm of 40°C air at 1/2 water pressure for each W of loss.

AC DRIVES/ SOLID STATE STARTERS SECTION

Effective: 01-01-2022
Supersedes: 07-06-2021



PACKAGED DRIVES

- NEMA 1, 12, 3R, 4, 4X (4, 4X are custom engineered packages)
- Bypass: Two and three contactor
 - Fused disconnects or circuit breakers
 - Soft start on bypass transfer
 - Automatic or manual bypass transfer
 - Fireman's override
 - Damper actuation circuit
 - Electrical and mechanical interlocks

OPTION CABINETS

- Fused disconnects or circuit breakers
- Wall mount or free standing

SPECIAL APPLICATIONS

- Power conditioning via harmonic filters or 12, 18 pulse systems
- Multiple motors on drive (bypass and options)
- Manual, duplex, triplex
- RS-485 Protocols
 - Modbus
 - BACNet
 - Johnson Metasys
 - Ethernet
 - Profibus
 - SCADA
- High elevations
- Surge suppression
- Phase monitoring
- RFI/ EMI Filtering

MOTOR AND DRIVE COMBINATION PACKAGES

Effective: 01-01-2022
Supersedes: 07-06-2021

Premium efficient Motor and Drive combination packages developed for both constant and variable torque applications.

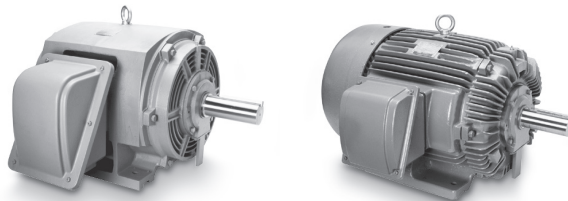

APPLICABLE MOTORS

- Rolled Steel and Cast Iron ODP
 - 143T through 5009B Frame
 - 1 to 500 HP
 - 1200, 1800, and 3600 RPM
- MAX-E1® type AEHE, AEHH8N
 - 143T through 6808B Frame
 - 1 to 800 HP
 - 900, 1200, 1800, and 3600 RPM
 - 230VAC to 125 HP, 460VAC to 800 HP

APPLICABLE VARIABLE FREQUENCY DRIVES

- EQ7 or A510 Drives for Constant Torque Applications
- EQ7 or F510 Drives for Variable Torque Applications
- 230VAC to 125 HP, 460VAC to 800 HP



- Single Source Reliability.
- **Contact your local TECO representative for additional discounts and warranties when purchasing matching motor and drive sets.**
- Select any combination of ODP or MAX-E1® premium efficient motors with any power-matched A510, F510, or EQ7 VFD.

APPLICATION GUIDELINES FOR PACKAGED COMBO MOTOR/VFD'S

Effective: 01-01-2022
Supersedes: 07-06-2021

VARIABLE FREQUENCY DRIVES

A Variable Frequency Drive (VFD) is a type of controller used to vary the speed of an electric motor. Input to the VFD is a fixed power supply that the VFD will then use to control the speed and torque of a given motor. Motor speed can be varied by changing the frequency of the power supply waveform. Output speed is:

$$\text{Speed} = \frac{120 * \text{Frequency}}{\text{Number of Motor Poles}}$$

VFD Operation

A VFD takes the fixed input frequency and voltage power supply and converts it to a controlled output PWM waveform at a voltage and frequency that is determined by the VFD. In so doing, the rotational speed of the motor can be controlled by the speed relationship indicated above.

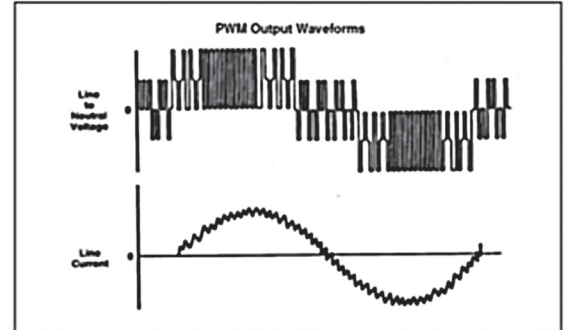

VFD & MOTOR COMPATIBILITY

Motor and Drive compatibility can be complex. Many variables should be considered when determining the suitability of a particular motor for use with a VFD. These variables include:

- Torque requirements (constant or variable)
- Speed range for control
- Line/system voltage
- Drive switching (carrier) frequency
- Motor construction
- Cable length and type of cable used between VFD and motor
- VFD dv/dt
- Temperature and humidity
- Grounding system

Extremes in some or all of these factors will add to the severity of the application and can result in premature motor failure.

VFD EFFECTS ON THE MOTOR

When a motor is powered by a PWM waveform the motor windings very often see a large differential voltage, either from phase to phase or turn to turn. When the voltage differential becomes great enough, ozone is created and there is a corona or partial discharge inside the motor. This energy is corrosive to the varnish on the motor windings. PWM waveforms can also magnify shaft voltages which lead to arcing across the bearing and causing a phenomena called fluting in the bearing race. This can lead to premature bearing failure and needs to have corrective action taken in order to avoid any issues.

INVERTER DUTY MOTORS

An inverter duty motor is defined as a motor that helps mitigate potential failure modes of a motor that is powered by a VFD. Inverter duty motor windings should be able to withstand the voltage spikes per NEMA MG1, Part 31 and protect against overheating when the motor is run at slow speeds. On thrust bearings it is apparent that the bearings require additional protection. Inverter duty vertical motors should have a shaft grounding device to protect the motor bearings from fluting due to voltage discharge through the bearing. On larger motors (100 HP and larger) the shaft should also be electrically isolated from the frame in order to aid the shaft grounding ring in discharging the shaft voltages to ground.

BEARING CURRENTS RELATED TO PWM WAVEFORMS

The following requirements are for cases where the purchaser has indicated that the motor will be operated on a VFD. These requirements must be met for the motor to be eligible for warranty on bearing fluting issues:

- For 400 frame and larger motors being operated on a VFD, TWMC requires the installation of (1) insulated bearing on non-drive end, a shaft ground brush on the DE, or a common mode filter, or choke on the output side of the VFD.
- For 215 frame up to 360 frame, TWMC requires installing a shaft ground brush on the DE, or a common mode filter, or choke on the output side of the VFD. **Note:** Shaft ground devices are considered wear items and must be serviced and/or replaced once it is detected that the device no longer reduces shaft current and prevents electrical discharging.
- In Division 2 hazardous locations where grounding brushes are not allowed, TWMC requires one insulated bearing on the NDE for frames 444/449 and larger and either one insulated bearing and common mode filter, or choke on the output side of the VFD.

It is recommended that the end user provide a common mode voltage mitigation device such as an isolation transformer, common mode filter, or choke, if shaft current and electrical discharging measurements on the VFD and motor application dictate more motor protection.

APPLICATION GUIDELINES FOR PACKAGED COMBO MOTOR/VFD'S

Effective: 01-01-2022
Supersedes: 07-06-2021

THERMAL OVERLOADS AND SINGLE PHASE MOTORS

Motors with thermal overloads may not operate properly on a VFD. The current carrying thermal overload is designed for a sine wave power supply and will be subject to rapid overheating when applied on PWM. Thermostats or thermistors that are independent of the motor leads and connected correctly to the VFD should provide suitable thermal overload protection when operating on a VFD (consult codes for installation requirements).

Single phase motors are not designed for inverter operation. Do not use a VFD to power a single phase motor.

GROUNDING AND CABLE INSTALLATION GUIDELINES

Proper output winding and grounding practices can be instrumental in minimizing motor related failures. VFD cable is critical for maximizing uptime and increasing the life cycle of motor systems. But not all cables are VFD cables. Cabling in a VFD system must carry power from AC drive systems to AC motors. As a result, the cables must not only handle high power current, but also the high voltage that can occur.

In the past, typical cabling solutions have included unshielded tray cables, single-conductor THHN wire or continuously welded armored cable (CCW). Not only do these products require complex, costly installation and introduce potential reliability problems, they also have proven to be ineffective in handling common mode current (noise) and voltage spikes or protecting against capacitive coupling. Most, including CCW, contain only the minimum ground copper required to comply with the NEC standards. THHN solid conductor is therefore not recommended. Use of stranded copper conductor wire is the recommended cable for use with TECO-Westinghouse VFD's.

SPECIAL GROUNDING CONSIDERATIONS FOR MOTORS OPERATING ON A VARIABLE FREQUENCY DRIVE (VFD)

When operating the motor with a VFD, special care must be taken for proper grounding to reduce the risk of bearing damage. Since their switching patterns are not sinusoidal, all VFD's produce a high frequency zero sequence voltage called common mode voltage (CMV). This CMV can cause damaging bearing currents in both the motor and the driven equipment. The VFD manufacturer should provide installation instructions that include the necessary cabling and grounding practices to ensure trouble free operation at the CMV levels generated by their VFD. CMV will travel through the lowest impedance path from the motor leads back to the VFD's ground bus. Due to the extremely high frequencies of the CMV waveform, it can travel across air gaps and insulation similar to how high frequency current flows across a capacitor. To reduce the risk that this path will include the motor or driven equipment bearings, a low impedance (at high frequency) ground conductor should be utilized to connect the motor frame to the VFD ground bus. It is recommended to utilize ground conductors within the motor cable bundle for providing this low impedance path to the VFD ground bus. The ground conductors and/or shield should have a maximum AC impedance at 1 MHz of 10 times the power conductor's DC resistance. If the high frequency impedance cannot be measured, then a ground conductor and/or shield DC resistance of a maximum of two times the power conductor's DC resistance should be sufficient. These ground conductors must be properly grounded to both the motor and the VFD ground bus. For applications (such as a pump) where the driven equipment offers a very low impedance path to ground, the CMV may generate current that flows across the shaft coupling to the driven equipment. This current may flow across the motor bearings and/or the driven equipment bearings, potentially causing damage. It is therefore recommended in such cases to either use an insulated coupling or to install a high frequency grounding strap between the motor and driven equipment frames to provide a path to the driven equipment's ground that does not involve the bearings. For additional information on recommended cable types and proper grounding methods for VFD operation, refer to IEC 60034-25.

MULTIPLE MOTORS ON A SINGLE VFD

Special considerations are required when multiple motors are powered from a single VFD. The VFD will typically not be able to distinguish one motor from another so overload protection will need to be provided for each individual motor. Starting and stopping the motors should be done simultaneously unless the VFD has been sized appropriately. Cable runs from the VFD and each motor can create conditions that will cause extra stress on the motor winding which may require filters to provide maximum motor life.

HUMIDITY AND NON-OPERATIONAL CONDITIONS

The possible build-up of condensation inside the motor due to storage in an uncontrolled environment or non-operational periods in an installation, can lead to an increased rate premature winding or bearing failure when combined with PWM waveform characteristics. Moisture and condensation in and on the motor winding over time can cause provide tracking paths to ground, lower the resistance of the motor winding to ground, and lower the Corona Inception Voltage (CIV) level of the winding. Proper storage and maintenance guidelines are important to minimize the potential for premature failures. Space heaters or trickle voltage heating methods are the common methods for drying out a winding that has low resistance readings. Damage or failure as a result of not following the application guideline as outlined in this document, are not covered by the limited warranty provided for the motor unless appropriate heating methods are utilized during non-operational periods and prior to motor startup.

APPLICATION GUIDELINES FOR PACKAGED COMBO MOTOR/VFD'S

Effective: 01-01-2022
Supersedes: 07-06-2021

WARRANTY GUIDELINES

The information in this section refers to the motor and VFD application limitations on warranty.

After date of failure, there is a 30 day period in which to file and process a claim.

HAZARDOUS LOCATION MOTORS

Consult TECO-Westinghouse Motor Company prior to use of a Variable Frequency Drive on TECO-Westinghouse motors intended for use in a Class 1, Division 2 or Class 1, Division 1. Those motors listed as Class 1 will need to have bearing shaft current issues addressed in such way as to mitigate shaft current without the use of grounding rings or brushes. Grounding rings or brushes are not permitted on hazardous location motors.

INPUT POWER AND MOTOR CABLE LENGTH

The length of the cable runs between input power source and /or VFD to motor can cause significant phase to phase voltage reduction due to voltage drop across the cables. To calculate use the formula:

$$V(\text{drop}) = \sqrt{3} * \text{resistance of cable} \left(\frac{\Omega}{\text{km}} \right) * \text{length of line (m)} * \text{current (Amps)}$$

CABLE DISTANCE - VFD TO MOTOR				
Cable Length VFD to Motor in m (ft)	≤ 30m -100	30 – 50m (100 – 165)	50 – 100 (166 – 328)	≥100 -329
Carrier Frequency	16kHz (max)	10kHz (max)	5kHz (max)	2kHz (max)

Additional filter may be recommended for cable lengths in excess of 400 ft. on 460V or greater VFD. The AC products within this catalog which include a turn down ratio were constructed to meet NEMA MG-1, Part 31 standard. As such, they are labeled Inverter Duty motors and are covered by warranty for 3 years (36 months) from date of sale, pending compliance with these guidelines and the nameplate information adhered to each motor.

L510 MICRO DRIVE

MEDIUM DUTY

Effective: 01-01-2022

Supersedes: 07-06-2021



A compact, low cost, and versatile AC drive that is easy to program and ideal for OEM's.

APPLICATIONS:

- Mixing
- Fans
- Small Conveyors
- Treadmills
- AC Contactor Replacement
- Pumps
- Lathes
- Milling

FEATURES:

- Chassis Style Enclosure (IP20)
- Sensorless Vector or V/ Hz with Auto Torque Boost Feature
- 0.25 to 1 HP, 115V, 50/ 60Hz, 1-Phase
- 0.25 to 3 HP, 230V, 50/ 60Hz, 1-Phase
- 0.5 to 3 HP, 230V, 50/ 60Hz, 3-Phase
- 1 to 3 HP, 460V, 50/ 60Hz, 3-Phase
- Extensive Diagnostic and Monitoring Capabilities
- Din Rail Option
- PID Control
- 8 Preset speeds
- Two Multi-Function Analog Input/ Qty 1 Analog Output
- Built-in Modbus or BACnet Protocol Via RJ 45 Interface
- UL, cUL, and CE Approved

L510 MICRO DRIVE



MEDIUM DUTY

Effective: 01-01-2022
Supersedes: 07-06-2021



115V 1-Phase Input/ 3-Phase 230V Output

MODEL NO.	HP CONSTANT TORQUE	DRIVE AMPS CONSTANT TORQUE	DIMENSIONS (in.)			APPROX. WT. (lbs.)	CONTROL LIST PRICE (\$)
			HEIGHT	WIDTH	DEPTH		
JNL510-202-H3-U	.25	1.8	5.55	2.83	5.48	2	316
JNL510-1P5-H1-U	.50	2.6	5.55	2.83	5.48	2	323
JNL510-101-H1-U	1	4.3	5.67	4.65	5.80	3.5	349

230V 1-Phase Input/ 3-Phase Output

MODEL NO.	HP CONSTANT TORQUE	DRIVE AMPS CONSTANT TORQUE	DIMENSIONS (in.)			APPROX. WT. (lbs.)	CONTROL LIST PRICE (\$)
			HEIGHT	WIDTH	DEPTH		
JNL510-2P2-H1-U	.25	1.8	5.55	2.83	5.48	2	297
JNL510-2P5-H1-U	.50	2.6	5.55	2.83	5.48	2	311
JNL510-201-H1-U	1	4.3	5.55	2.83	5.48	2	320
JNL510-202-H1-U	2	7.5	5.67	4.65	5.80	3.5	441
JNL510-203-H1-U	3	10.5	5.67	4.65	5.80	3.5	527

230V 3-Phase Input/ 3-Phase Output

MODEL NO.	HP CONSTANT TORQUE	DRIVE AMPS CONSTANT TORQUE	DIMENSIONS (in.)			APPROX. WT. (lbs.)	CONTROL LIST PRICE (\$)
			HEIGHT	WIDTH	DEPTH		
JNL510-2P5-H3-U	.50	2.6	5.55	2.83	5.48	2	311
JNL510-201-H3-U	1	4.3	5.55	2.83	5.48	2	320
JNL510-202-H3-U	2	7.5	5.67	4.65	5.80	3.5	434
JNL510-203-H3-U	3	10.5	5.67	4.65	5.80	3.5	482

460V 3-Phase Input/ 3-Phase Output

MODEL NO.	HP CONSTANT TORQUE	DRIVE AMPS CONSTANT TORQUE	DIMENSIONS (in.)			APPROX. WT. (lbs.)	CONTROL LIST PRICE (\$)
			HEIGHT	WIDTH	DEPTH		
JNL510-401-H3-U	1	2.3	5.67	4.65	5.80	3.5	446
JNL510-402-H3-U	2	3.8	5.67	4.65	5.80	3.5	489
JNL510-403-H3-U	3	5.2	5.67	4.65	5.80	3.5	593

Notes:

- H1 = 1-Phase
- H3 = 3-Phase

All Digital Inputs are Sunked to Control Power Common

L510 BRAKE RESISTORS & OPTIONS

Effective: 01-01-2022
 Supersedes: 07-06-2021



All resistor sets are not in an enclosure (chassis).

460V 3-Phase

AC DRIVE HP RATING	BRAKING TRANSISTOR			BRAKING RESISTOR							
	MODEL NO.	QTY USED	LIST PRICE (\$)	MODEL NO.	QTY	RESISTANCE OHMS - WATTS		ENCLOSURE DIMENSIONS (in.)	BRAKING TORQUE %	DUTY CYCLE %	LIST PRICE (\$)
1	-	-	-	JNBR-150W750	1	750	150	12"L x 5"W x 5"D	126	10	30
2	-	-	-	JNBR-150W400	1	400	150	12"L x 5"W x 5"D	119	10	35
3	-	-	-	JNBR-260W250	1	250	260	12"L x 5"W x 5"D	126	10	50

Notes:

Transistor built-in for all L510 460V ratings (braking resistors externally mounted)

- * Option only available for 460V ratings
- ** Pricing is for the quantity of the one (1) unit.

Options

PART NUMBER	DESCRIPTION	LIST PRICE (\$)
JN5-CB-01M	Extension wire (1M)	25
JN5-CB-02M	Extension wire (2M)	27
JN5-CB-03M	Extension wire (3M)	30
JN5-CB-05M	Extension wire (5M)	35
JN5-CM-USB	USB cable to connect PC	80
JN5-CU	Copy module (Also usable as a remote LED operator)	95
JN5-DIN-L01	DIN RAIL, L510, FRAME 1	25
DINE2-201	DIN RAIL, L510, FRAME 2 (Plastic Only)	35
JN5-OP-L01	Remote Keypad	200

E510 COMPACT



MEDIUM DUTY

Effective: 01-01-2022
Supersedes: 07-06-2021



The E510 compact AC drive is an easily configured drive that controls many applications. From simple fixed speed set ups to applications requiring PM motors, the E510 meets the application challenge. This product replaces our Legacy product the N3.

APPLICATIONS:

- Conveyors
- Mixing Equipment
- Fans and Blowers
- Compact size is convenient for retrofitting/ replacing an older generation VFD
- Pumps
- Lathes
- AC Contactor Replacement

FEATURES:

- 0.5 to 3 HP (CT), 230V, 50/ 60Hz, 1-Phase
- 0.5 to 40 HP (CT), 460V, 50/ 60Hz, 3-Phase
- 1 to 75 HP (CT), 460V, 50/ 60Hz, 3-Phase
- Parameters grouped by function
- Built-in PLC Functionality
- PID Process Control Loop
- Built-in Modbus & BACnet Protocols
- 5 Digit operator's keypad with speed pot
- Digital and Analog Inputs and outputs have extremely fast (~4 msec) update time"
- Auto Run Mode (cyclic operation)
- Power loss ride through
- Automatic Voltage Regulation (AVR)
- Complies with IEC 60018-2-78, UL, cUL, CE, & RoHS

E510 COMPACT DRIVE



Effective: 01-01-2022
Supersedes: 07-06-2021

MEDIUM DUTY



230V 1/3-Phase

MODEL NO.	DRIVE HP		DRIVE OUTPUT AMPS		DIMENSIONS (Inches)			APPROX. WT. (lbs.)	CONTROL LIST PRICE (\$)
	CONSTANT TORQUE	VARIABLE TORQUE	CONSTANT TORQUE	VARIABLE TORQUE	HEIGHT	WIDTH	DEPTH		
JNE510-2P5-H-U	0.5	0.5	3.1	3.1	6.46	3.57	5.96	3.5	422
JNE510-201-H-U	1	1	4.5	4.5	6.46	3.57	5.96	3.5	453
JNE510-202-H-U	2	2	7.5	7.5	7.39	5.07	6.00	5.5	577
JNE510-203-H-U	3	3	10.5	10.5	7.39	5.07	6.00	5.5	721

230V 3-Phase

MODEL NO.	DRIVE HP		DRIVE OUTPUT AMPS		DIMENSIONS (Inches)			APPROX. WT. (lbs.)	CONTROL LIST PRICE (\$)
	CONSTANT TORQUE	VARIABLE TORQUE	CONSTANT TORQUE	VARIABLE TORQUE	HEIGHT	WIDTH	DEPTH		
JNE510-202-H3-U	2	2	7.5	7.5	6.46	3.57	5.96	3.5	649
JNE510-205-H3-U	5	5	17.5	17.5	7.39	5.07	6.00	5.5	731
JNE510-208-H3-U	7.5	7.5	26	26	10.27	7.36	7.98	14.3	1,030
JNE510-210-H3-U	10	10	35	35	10.27	7.36	7.98	14.3	1,195
JNE510-215-H3-U	15	15	48	48	12.66	8.84	8.11	22.3	1,895
JNE510-220-H3-U	20	20	64	64	12.66	8.84	8.11	22.9	2,101
JNE510-225-H3-U	25	25-30	73	80	14.17	10.43	9.38	22.1	2,730
JNE510-230-H3-U	30	40	85	110	20.67	11.28	10.62	66.1	3,811
JNE510-240-H3-U	40	50	115	138	20.67	11.28	10.62	66.1	5,140

460V 3-Phase

MODEL NO.	DRIVE HP		DRIVE OUTPUT AMPS		DIMENSIONS (Inches)			APPROX. WT. (lbs.)	CONTROL LIST PRICE (\$)
	CONSTANT TORQUE	VARIABLE TORQUE	CONSTANT TORQUE	VARIABLE TORQUE	HEIGHT	WIDTH	DEPTH		
JNE510-401-H3-U	1	1	2.5	2.5	6.46	3.57	5.96	3.8	474
JNE510-402-H3-U	2	2	3.8	3.8	6.46	3.57	5.96	3.8	515
JNE510-403-H3-U	3	3	5.3	5.3	7.39	5.07	6.00	5.5	700
JNE510-405-H3-U	5	5	9.2	9.2	7.39	5.07	6.00	5.5	773
JNE510-408-H3-U	7.5	7.5	13	13	10.27	7.36	7.98	14.3	1,071
JNE510-410-H3-U	10	10	17.5	17.5	10.27	7.36	7.98	14.3	1,246
JNE510-415-H3-U	15	15	24	24	10.27	7.36	7.98	14.3	1,380
JNE510-420-H3-U	20	20	32	32	12.66	8.84	8.11	23.2	2,142
JNE510-425-H3-U	25	25	40	40	12.66	8.84	8.11	23.2	2,688
JNE510-430-H3-U	30	30-40	45	58	14.17	10.43	9.38	22.1	2,956
JNE510-440-H3-U	40	50	60	73	20.67	11.28	10.62	66.1	3,893
JNE510-450-H3-U	50	60	75	88	20.67	11.28	10.62	66.1	4,779
JNE510-460-H3-U	60	75	91	103	20.67	11.28	10.62	66.1	5,428
JNE510-475-H3-U	75	100	118	145	20.67	11.28	10.62	77.2	6,232

E510 OPTIONS



MEDIUM DUTY

Effective: 01-01-2022
Supersedes: 07-06-2021

E510 COMPACT DRIVE PERIPHERALS ONLY

TECO MODEL	DESCRIPTION	CONTROL LIST PRICE (\$)
N5-CB-01M	Extension wire (1M)	25
JN5-CB-02M	Extension wire (2M)	27
JN5-CB-03M	Extension wire (3M)	30
JN5-CB-05M	Extension wire (5M)	35
*JN5-NK-E01	E510 Frame 1 NEMA1 KIT (REPLACEMENT)	40
*JN5-NK-E02	E510 Frame 2 NEMA1 KIT (REPLACEMENT)	55
*JN5-NK-E03	E510 Frame 3 NEMA1 KIT (REPLACEMENT)	65
*JN5-NK-E04	E510 Frame 4 NEMA1 KIT (REPLACEMENT)	77
JN5-CM-USB	USB cable to connect PC	80
JN5-OP-A02	IP20 LCD Operator Panel Mount (Remote Use Only)	135
JN5-KEYBOX	Remote keypad holder (Only for LED Keypad)	33
JN5-CU	Copy unit (ONLY)	95
JN5-CMI-PDP	PROFIBUS communication interface module	350
JN5-CMI-TCPIP	TCPIP Card	410
JN5-CMI-DNET	DeviceNet Card	220
JN5-CMI-CAN	CanOpen Card	220
JN5-DINF1	DIN KIT OPTION KIT FRAME 1	43
JN5-DINF2	DIN KIT OPTION KIT FRAME 2	59

All resistor sets are not in an enclosure (chassis).



E510 BRAKE MODULES AND RESISTORS

230V 1/3-Phase

AC DRIVE HP RATING	BRAKING TRANSISTOR			BRAKING RESISTOR							
	MODEL NO.	QTY USED	CONTROL LIST PRICE (\$)	MODEL NO.	QTY USED	RESISTANCE OHMS WATTS	ENCLOSURE DIMENSIONS (in.)	BRAKING TORQUE %	DUTY CYCLE %	LIST PRICE (\$)	
1	X	-	-	JNBR-150W100	1	100 150	12"L x 5"W x 5"D	117	10	35	
2	X	-	-	JNBR-150W100	1	100 150	12"L x 5"W x 5"D	117	10	35	
3	X	-	-	JNBR-260W70	1	70 260	12"L x 5"W x 5"D	112	10	50	

230V 3-Phase

AC DRIVE HP RATING	BRAKING TRANSISTOR			BRAKING RESISTOR							
	MODEL NO.	QTY USED	CONTROL LIST PRICE (\$)	MODEL NO.	QTY USED	RESISTANCE OHMS WATTS	ENCLOSURE DIMENSIONS (in.)	BRAKING TORQUE %	DUTY CYCLE %	LIST PRICE (\$)	
5	X	-	-	JNBR-390W40	1	40 390	12"L x 5"W x 5"D	117	10	70	
7.5	X	-	-	JNBR-520W30	1	30 520	12"L x 7"W x 5"D	123	10	125	
10	X	-	-	JNBR-780W20	1	20 780	12"L x 7"W x 5"D	117	10	150	
15	X	-	-	JNBR-2R4KW13R6	1	13.6 2400	19"L x 10"W x 5"D	100	10	450	
20	X	-	-	JNBR-3KW10	1	10 3000	19"L x 13"W x 5"D	119	10	575	
25	X	-	-	JNBR-4R8KW8	1	8 4800	26.5"L x 10"W x 5"D	119	10	940	
30	X	-	-	JNBR-4R8KW6R8	1	6.8 4800	26.5"L x 10"W x 5"D	117	10	955	
40	JNTBU-230	2	475	JNBR-3KW10	2	10 3000	19"L x 13"W x 5"D	119	10	575	

460V 3-Phase

AC DRIVE HP RATING	BRAKING TRANSISTOR			BRAKING RESISTOR							
	MODEL NO.	QTY USED	CONTROL LIST PRICE (\$)	MODEL NO.	QTY USED	RESISTANCE OHMS WATTS	ENCLOSURE DIMENSIONS (in.)	BRAKING TORQUE %	DUTY CYCLE %	LIST PRICE (\$)	
1	X	-	-	JNBR-150W750	1	750 150	12"L x 5"W x 5"D	123	10	30	
2	X	-	-	JNBR-150W400	1	400 150	12"L x 5"W x 5"D	117	10	35	
3	X	-	-	JNBR-260W250	1	250 260	12"L x 5"W x 5"D	123	10	50	
5	X	-	-	JNBR-400W150	1	150 400	12"L x 5"W x 5"D	123	10	75	
7.5	X	-	-	JNBR-600W130	1	130 600	12"L x 7"W x 5"D	123	10	125	
10	X	-	-	JNBR-800W100	1	100 800	12"L x 7"W x 5"D	117	10	150	
15	X	-	-	JNBR-1R6KW50	1	50 1600	12"L x 10"W x 5"D	149	10	300	
20	X	-	-	JNBR-1R5KW40	1	40 1500	12"L x 13"W x 5"D	100	10	300	
25	X	-	-	JNBR-4R8KW32	1	32 4800	26.5"L x 13"W x 5"D	120	10	900	
30	X	-	-	JNBR-4R8KW27R2	1	27.2 4800	26.5"L x 13"W x 5"D	117	10	900	
40	X	-	-	JNBR-6KW20	1	20 6000	26.5"L x 13"W x 5"D	117	10	1,100	
50	JNTBU-430	2	605	JNBR-4R8KW32	2	32 4800	28"L x 10"W x 10"D	117	10	900	
60	JNTBU-430	2	605	JNBR-4R8KW27R2	2	27.2 4800	28"L x 10"W x 10"D	117	10	900	
75	JNTBU-430	2	605	JNBR-6KW20	2	20 6000	26.5"L x 13"W x 5"D	117	10	1,100	

X = Transistor Built-in for all E510 Compact Drives at these ratings

All brake resistor units include thermal overload switches.

** Pricing is for the quantity of the one (1) unit

E510 NEMA 4, 4X/12 (INDOOR USE ONLY)



Effective: 01-01-2022
Supersedes: 07-06-2021

MEDIUM DUTY



A versatile AC drive that can control the most demanding motor driven applications, this highly flexible drive has multiple control modes and built-in PLC functionality.

APPLICATIONS:

- Mixers
- Conveyors
- Machine Tools
- Pumps (Centrifugal, Positive Displacement, Metering, etc.)
- Packaging Machines
- Fans

FEATURES:

- Control Modes for V/F, and Sensorless Vector
- Simple PLC Function Built-in
- .5 to 20 HP (CT), 230V, 50/ 60Hz, 3-Phase
- 1 to 25 HP (CT), 460V, 50/ 60Hz, 3-Phase
- Conformal Coating on PC Boards
- LED Keypad with 5 Digits
- Flexible Input/ Output Configurations that Accept Normally Open or Normally Closed Signals
- 0 to 599 Hz Speed Range
- PID Control
- Diagnostics Registers for Troubleshooting
- Built-in Modbus Protocol via (RJ45 Interface)
- Dedicated Pulse Follower Signal
- UL, cUL, and CE Approved

E510 NEMA 4, 4X/12 WITH DISCONNECT SWITCH



MEDIUM DUTY (INDOOR ONLY)

Effective: 01-01-2022
Supersedes: 07-06-2021



230V 1-Phase Input/ 3-Phase Output

MODEL NO.	CONSTANT TORQUE		DIMENSIONS (in.)			APPROX. WT. (lbs.)	CONTROL LIST PRICE (\$)
	HP	DRIVE AMPS	HEIGHT	WIDTH	DEPTH		
JNE510-2P5-H1FN4SU	0.5	3.1	9.79	5.94	7.87	6	762
JNE510-201-H1FN4SU	1	4.3	9.79	5.94	7.87	6	803
JNE510-202-H1FN4SU	2	7.5	13.19	7.80	9.26	13	1,040
JNE510-203-H1FN4SU	3	10.5	13.19	7.80	9.26	13	1,215

460V 3-Phase Input/ 3-Phase Output

MODEL NO.	CONSTANT TORQUE		DIMENSIONS (in.)			APPROX. WT. (lbs.)	CONTROL LIST PRICE (\$)
	HP	DRIVE AMPS	HEIGHT	WIDTH	DEPTH		
JNE510-401-H3FN4SU	1	2.3	9.79	5.94	7.87	6	968
JNE510-402-H3FN4SU	2	3.8	9.79	5.94	7.87	6	1,040
JNE510-403-H3FN4SU	3	5.2	13.19	7.80	9.26	13	1,246
JNE510-405-H3FN4SU	5	8.8	13.19	7.80	9.26	13	1,555
JNE510-408-H3FN4SU	7.5	13.0	18.11	8.77	10.37	28	2,101
JNE510-410-H3FN4SU	10	17.5	18.11	8.77	10.37	28	2,266
JNE510-410-H3FN4SU	15	25.0	18.11	8.77	10.37	28	2,678

E510 NEMA 4, 4X/12 WITHOUT DISCONNECT SWITCH

MEDIUM DUTY



230V 3-Phase Input/ 3-Phase Output

MODEL NO.	CONSTANT TORQUE		DIMENSIONS (in.)			APPROX. WT. (lbs.)	CONTROL LIST PRICE (\$)
	HP	DRIVE AMPS	HEIGHT	WIDTH	DEPTH		
*JNE510-2P5-HN4R-U	0.5	3.1	9.79	5.94	7.87	6	752
*JNE510-201-HN4R-U	1	4.5	9.79	5.94	7.87	6	793
*JNE510-202-HN4R-U	2	7.5	13.19	7.80	9.26	13	989
*JNE510-203-HN4R-U	3	10.5	13.19	7.80	9.26	13	1,185
JNE510-205-H3N4-U	5	17.5	13.19	7.80	8.60	13	1,597
JNE510-208-H3N4-U	7.5	26.0	18.11	8.77	9.71	28	1,792
JNE510-210-H3N4-U	10	35.0	18.11	8.77	9.71	28	2,142
JNE510-215-H3N4-U	15	48.0	18.11	8.77	9.71	28	2,668
JNE510-220-H3N4-U	20	64.0	18.11	8.77	9.71	28	2,791

*Can Supply Either Single or Three Phase 230V Input. Also includes speed pot mounted on front cover.

460V 3-Phase Input/ 3-Phase Output

MODEL NO.	CONSTANT TORQUE		DIMENSIONS (Inches)			APPROX. WT. (lbs.)	CONTROL LIST PRICE (\$)
	HP	DRIVE AMPS	HEIGHT	WIDTH	DEPTH		
JNE510-401-H3N4-U	1	2.3	9.79	5.94	7.20	6	958
JNE510-402-H3N4-U	2	3.8	9.79	5.94	7.20	6	1,020
JNE510-403-H3N4-U	3	5.2	13.19	7.80	8.60	13	1,215
JNE510-405-H3N4-U	5	8.8	13.19	7.80	8.60	13	1,473
JNE510-408-H3N4-U	7.5	13	18.11	8.77	9.71	28	1,957
JNE510-410-H3N4-U	10	17.5	18.11	8.77	9.71	28	2,184
JNE510-415-H3N4-U	15	25	18.11	8.77	9.71	28	2,390
JNE510-420-H3N4-U	20	32	18.11	8.77	9.71	28	2,956
JNE510-425-H3N4-U	25	40	18.11	8.77	9.71	28	3,069

*Can Supply Either Single or Three Phase 230V Input. Also includes speed pot mounted on front cover.

E510 NEMA 4, 4X/12 OPTIONS



MEDIUM DUTY

Effective: 01-01-2022
Supersedes: 07-06-2021



Options

PART NUMBER	DESCRIPTION	CONTROL LIST PRICE (\$)
JN5-CM-PDP	PROFIBUS Communication Interface Module	350
JN5-CM-USB	USB Cable to Connect PC	80
JN5-CU	Copy Module (ONLY)	95

E510 NEMA 4, 4X/12 BRAKE MODULES AND RESISTORS



MEDIUM DUTY

Effective: 01-01-2022
Supersedes: 07-06-2021

230V 3-Phase*

AC DRIVE HP RATING	BRAKING TRANSISTOR		
	MODEL NUMBER	QTY USED	LIST PRICE (\$) EACH
V	X	-	-
2	X	-	-
3	X	-	-
5	X	-	-
7.5	X	-	-
10	X	-	-
15	X	-	-
20	X	-	-



All resistor sets are not in an enclosure (chassis).

X = Transistor Built-in for all E510 NEMA 4, 4X/12 drives at these ratings

230V 3-Phase*

AC DRIVE HP RATING	MODEL NUMBER	QTY USED	BRAKING RESISTOR					LIST PRICE (\$) EACH
			RESISTANCE OHMS WATTS	ENCLOSURE DIMENSIONS (in.)	BRAKING TORQUE %	DUTY CYCLE %		
.5-1	JNBR-150W200	1	200	150	9.88"L x 1.10"W x 2.36"D	119	10	30
2	JNBR-150W100	1	100	150	9.88"L x 1.10"W x 2.36"D	119	10	35
3	JNBR-260W70	1	70	260	10.79"L x 1.34"W x 3.07"D	115	10	50
5	JNBR-390W40	1	40	390	10.79"L x 1.34"W x 3.07"D	119	10	70
7.5	JNBR-520W30	1	30	520	15.7"L x 1.57"W x 3.94"D	108	10	125
10	JNBR-780W20	1	20	780	15.7"L x 1.57"W x 3.94"D	119	10	150
15	JNBR-2R4KW13R6	1	13.6	2400	21.1"L x 1.96"W x 4.33"D	117	10	450
20	JNBR-3KW10	1	10	3000	24.21"L x 1.96"W x 4.33"D	119	10	575

460V 3-Phase*

AC DRIVE HP RATING	BRAKING TRANSISTOR		
	MODEL NUMBER	QTY USED	LIST PRICE (\$) EACH
1	X	-	-
2	X	-	-
3	X	-	-
5	X	-	-
7.5	X	-	-
10	X	-	-
15	X	-	-
20	X	-	-
25	JNTBU-430	1	605

X = Transistor Built-in for all E510 NEMA 4, 4X/12 drives at these ratings

460V 3-Phase*

AC DRIVE HP RATING	MODEL NUMBER	QTY USED	BRAKING RESISTOR					LIST PRICE (\$) EACH
			RESISTANCE OHMS WATTS	ENCLOSURE DIMENSIONS (in.)	BRAKING TORQUE %	DUTY CYCLE %		
1	JNBR-150W750	1	750	150	9.88"L x 1.10"W x 2.36"D	126	10	30
2	JNBR-150W400	1	400	150	9.88"L x 1.10"W x 2.36"D	119	10	35
3	JNBR-260W250	1	250	260	10.79"L x 1.34"W x 3.07"D	126	10	50
5	JNBR-400W150	1	150	400	10.79"L x 1.34"W x 3.07"D	126	10	75
7.5	JNBR-600W130	1	130	600	15.7"L x 1.57"W x 3.94"D	102	10	125
10	JNBR-800W100	1	100	800	24.21"L x 1.96"W x 4.33"D	99	10	150
15	JNBR-1R6KW50	1	50	1600	24.21"L x 1.96"W x 4.33"D	126	10	300
20	JNBR-1R5KW40	1	40	1500	24.21"L x 1.96"W x 4.33"D	119	10	300
25	JNBR-4R8KW32	1	32	4800	21.1"L x 1.96"W x 4.33"D	119	10	900

Notes:

* = All brake modules and resistors are chassis (not in an enclosure)

** Pricing for the quantity of one (1) unit



A versatile AC drive that can control today's demanding motor driven applications, this highly flexible drive has multiple control modes.

APPLICATIONS:

- Mixing
- Conveyors
- Packaging Machines
- Machine Tools
- Fans
- Compressors
- Pumps (Centrifugal, Positive Displacement, Metering, etc.)
- Extrusion and Injection Molding
- Winders/ Unwinders
- Crushers/ Grinders
- Crain/ Hoist

FEATURES:

- Control Modes for V/F, V/F with PG feedback, Sensorless Vector, and Closed Loop Vector
- Simple PLC Function Built-in
- Advanced Regenerative Load Handling Capability
- 1 to 100 HP (CT), 230V, 50/ 60Hz, 3-Phase
- 1 to 125 HP(VT), 230V, 50/ 60Hz,3-Phase
- 1 to 400 HP (CT), 460V, 50/ 60Hz,3-Phase
- 1 to 400 HP (VT), 460V, 50/ 60Hz,3-Phase
- 1 to 10 HP (CT/VT), 575V, 50/ 60Hz,3-Phase
- 15 to 250 HP (CT), 690V, 50/ 60Hz,3-Phase
- 15 to 270 HP (VT), 690V, 50/ 60Hz,3-Phase
- Conformal Coating on PC Boards
- LCD Keypad that is Remotely Mountable
- Flexible Input/ Output Configurations that Accept Normally Open or Normally Closed Signals
- 0 to 599 Hz Speed Range
- PID Control
- Diagnostics Registers for Troubleshooting
- Built-in RS485 Modbus Protocol
- Enhanced Design for Quiet Motor Operation
- Pulse Output and Pulse Follower
- Select Between Closed-Loop Speed and Torque Control in Vector Mode
- UL, cUL, and CE approved

A510



HEAVY DUTY

Effective: 01-01-2022
Supersedes: 07-06-2021



230V 3-Phase

MODEL NO.	HP		DRIVE AMPS		DIMENSIONS (in.)			APPROX. WT. (lbs.)	CONTROL LIST PRICE (\$)
	CONSTANT TORQUE	VARIABLE TORQUE	CONSTANT TORQUE	VARIABLE TORQUE	HEIGHT	WIDTH	DEPTH		
^*JNA510-2001-C-UE	1	1	5.0	6.0	9.61	5.12	5.91	6	670
^*JNA510-2002-C-UE	2	2-3	8.0	9.6	9.61	5.12	5.91	6	700
^*JNA510-2003-C-UE	3	3	11.0	12.0	12.40	5.51	6.97	9	865
*JNA510-2005-C3-UE	5	5-7.5	17.5	22.0	12.40	5.51	6.97	9	906
*JNA510-2008-C3-UE	7.5	10	25.0	30.0	12.40	5.51	6.97	10	1,318
*JNA510-2010-C3-UE	10	15	33.0	42.0	11.80	8.27	8.46	10	1,432
*JNA510-2015-C3-UE	15	20	47.0	56.0	14.20	10.43	8.86	20	1,895
*JNA510-2020-C3-UE	20	25	60.0	69.0	14.20	10.43	8.86	20	2,297
*JNA510-2025-C3-UE	25	30	73.0	79.0	14.20	10.43	8.86	20	2,956
JNA510-2030-C3-UE	30	40	85.0	110.0	20.70	11.20	9.92	70	4,666
JNA510-2040-C3-UE	40	50	115.0	138.0	20.70	11.20	9.92	70	5,768
**JNA510-2050-C3-UE	50	60	145.0	169.0	22.80	13.54	11.81	90	7,148
**JNA510-2060-C3-UE	60	75	180.0	200.0	22.80	13.54	11.81	90	8,364
**JNA510-2075-C3-UE	75	100	215.0	250.0	31.10	18.10	12.80	200	10,156
**JNA510-2100-C3-UE	100	125	283.0	312.0	31.10	18.10	12.80	200	12,690

460V 3-Phase

MODEL NO.	HP		DRIVE AMPS		DIMENSIONS (in.)			APPROX. WT. (lbs.)	CONTROL LIST PRICE (\$)
	CONSTANT TORQUE	VARIABLE TORQUE	CONSTANT TORQUE	VARIABLE TORQUE	HEIGHT	WIDTH	DEPTH		
*JNA510-4001-C3-UE	1	1	3.4	4.1	9.61	5.12	5.91	6	690
*JNA510-4002-C3-UE	2	2-3	4.2	5.4	9.61	5.12	5.91	6	721
*JNA510-4003-C3-UE	3	3	5.5	6.9	9.61	5.12	5.91	6	876
*JNA510-4005-C3-UE	5	5-7.5	9.2	12.1	12.40	5.51	6.97	9	979
*JNA510-4008-C3-UE	7.5	10	14.8	17.5	12.40	5.51	6.97	9	1,421
*JNA510-4010-C3-UE	10	15	18.0	23.0	11.80	8.27	8.46	10	1,627
*JNA510-4015-C3-UE	15	20	24.0	31.0	11.80	8.27	8.46	10	1,947
*JNA510-4020-C3-UE	20	25	31.0	38.0	11.80	8.27	8.46	10	2,328
*JNA510-4025-C3-UE	25	30	39.0	44.0	14.20	10.43	8.86	20	2,894
*JNA510-4030-C3-UE	30	40	45.0	58.0	14.20	10.43	8.86	20	3,080
*JNA510-4040-C3-UE	40	50	60.0	73.0	20.70	11.20	9.92	70	4,089
JNA510-4050-C3-UE	50	60	75.0	88.0	20.70	11.20	9.92	70	4,934
JNA510-4060-C3-UE	60	75	91.0	103.0	20.70	11.20	9.92	70	5,624
**JNA510-4075-C3-UE	75	100	118.0	145.0	20.70	13.54	11.81	77	7,035
**JNA510-4100-C3-UE	100	125	150.0	168.0	22.80	13.54	11.81	90	11,515
**JNA510-4125-C3-UE	125	150	180.0	208.0	22.80	13.54	11.81	200	14,770
**JNA510-4150-C3-UE	150	175	216.0	250.0	31.10	18.10	12.80	200	17,077
**JNA510-4215-C3-UE	215	250	295.0	328.0	31.10	18.10	12.80	200	19,838
**JNA510-4270-C3-UE	250	250	380.0	435.0	39.37	27.16	16.14	405	24,802
**JNA510-4300-C3-UE	300	300	450.0	515.0	39.37	27.16	16.14	405	25,317
**JNA510-4375-C3-UE	350	400	523.0	585.0	39.37	27.16	16.14	405	29,530
**JNA510-4425-C3-UE	400	400	585.0	585.0	39.37	27.16	16.14	405	43,260

* Includes Dynamic Braking Transistor

** Includes DC Bus Link Reactor

^ Operates on single or three phase inputs at specified rating

NOTE: 1-40 HP, NEMA 1, 230 V, 50 HP & above, protected chassis; 1-75 HP, NEMA 1, 460 V, 100HP and above, protected chassis

A510



HEAVY DUTY

Effective: 01-01-2022
Supersedes: 07-06-2021



‡ 575V 3-Phase and ***690V 3-Phase
Contact TECO-Westinghouse for delivery, 1-800-279-4007.

‡ 575V 3-Phase

MODEL NO.	HP		DRIVE AMPS		DIMENSIONS (in.)			APPROX. WT. (lbs.)	CONTROL LIST PRICE (\$)
	CONSTANT TORQUE	VARIABLE TORQUE	CONSTANT TORQUE	VARIABLE TORQUE	HEIGHT	WIDTH	DEPTH		
*JNA510-5001-C3-UE	1	2	1.7	3.0	12.4	5.51	6.96	8	1,329
*JNA510-5002-C3-UE	2	3	3.0	4.2	12.4	5.51	6.96	8	1,380
*JNA510-5003-C3-UE	3	4	4.2	5.8	12.4	5.51	6.96	8	1,483
*JNA510-5005-C3-UE	5	5	6.6	8.8	11.81	8.26	8.46	10	1,524
*JNA510-5008-C3-UE	7.5	7.5-10	9.9	12.2	11.81	8.26	8.46	10	1,669
*JNA510-5010-C3-UE	10	10	11.4	14.5	11.81	8.26	8.46	10	1,730

***690V 3-Phase

MODEL NO.	HP		DRIVE AMPS		DIMENSIONS (in.)			APPROX. WT. (lbs.)	CONTROL LIST PRICE (\$)
	CONSTANT TORQUE	VARIABLE TORQUE	CONSTANT TORQUE	VARIABLE TORQUE	HEIGHT	WIDTH	DEPTH		
*JNA510-6015-C3-UE	15	20	15.0	19.0	14.17	10.43	8.85	20	2,297
*JNA510-6020-C3-UE	20	25	22.0	22.0	14.17	10.43	8.85	20	2,709
*JNA510-6025-C3-UE	25	30	22.0	27.0	14.17	10.43	8.85	20	3,378
*JNA510-6030-C3-UE	30	40	27.0	34.0	14.17	10.43	8.85	20	3,461
JNA510-6040-C3-UE	40	50	34.0	42.0	14.17	10.43	8.85	20	4,439
JNA510-6050-C3-UE	50	60	42.0	52.0	20.66	11.18	9.92	70	5,305
JNA510-6060-C3-UE	60	75	54.0	62.0	20.66	11.18	9.92	70	6,602
**JNA510-6075-C3-UE	75	100	62.0	80.0	20.66	11.18	9.92	70	7,684
**JNA510-6100-C3-UE	100	125	86.0	99.0	22.83	13.54	11.81	90	9,332
**JNA510-6125-C3-UE	125	150	99.0	125.0	22.83	13.54	11.81	90	12,927
**JNA510-6150-C3-UE	150	175	131.0	147.0	22.83	13.54	11.81	90	15,090
**JNA510-6215-C3-UE	200	250	163.0	212.0	31.10	18.07	12.77	200	22,176
**JNA510-6250-C3-UE	250	270	193.0	216.0	31.10	18.07	12.77	200	24,586

Notes:

- * Includes Dynamic Braking Transistor
- ** Includes DC Bus Link Reactor
- *** Consult factory when applying 575V to 690V models
- ‡ Do not apply 690V to these models
1-10 HP NEMA 1: 575V, 15-75 HP; NEMA 1: 690V, 100 HP and above, protected chassis

A510 OPTIONS



HEAVY DUTY

Effective: 01-01-2022

Supersedes: 07-06-2021



Options

PART NUMBER	DESCRIPTION	LIST PRICE (\$)
JN5-CB-01M	Remote Wire for Keypad (1M)	25
JN5-CB-02M	Remote Wire for Keypad (2M)	27
JN5-CB-03M	Remote Wire for Keypad (3M)	30
JN5-CB-05M	Remote Wire for Keypad (5M)	35
JN5-CM-PDP	PROFIBUS Communication Interface Module	350
JN5-CM-USB	USB Cable to Connect PC	80
JN5-CU	Copy Module (ONLY)	95
JN5-NK-A06	A510 Frame 6 NEMA1 KIT 50, 60HP 230V; 100,125HP 460V,100,125,150HP 690V	475
JN5-NK-A07	A510 Frame 7 NEMA1 KIT 75,100HP 230V;150,200HP 460V; 200,250HP 690V	690
JN5-NK-A08	A510-Frame 8 NEMA 1 KIT 250,300,350,400HP 460V	710
JN5-OP-A01	LED Operator	75
JN5-OP-A02	LCD Operator Replacement*	135
JN5-OP-A03	Blank Operator	25
JN5-PG-L	Line Driver Speed Feedback Card	130
JN5-PG-O	Open Collector Speed Feedback Card	160
JN5-PG-PM	Synchronous Motor Line Driver Speed Feedback Card	140
JN5-IO-2DO1AI	Digital&Analog IO Expansion Card	275
JN5-MD-A01	Middle Layer Case for Frame1*	42
JN5-MD-A02	Middle Layer Case for Frame2**	50
JN5-MD-A03	Middle Layer Case for Frame3**	55
JN5-MD-A04	Middle Layer Case for Frame4**	59

*LCD Operator is standard on all A510 models

*Note Frame 1: Middle layer case is required when using plug-in option cards

** Note Frame 2~4: Middle layer case is only required when using 2 plug-in option cards

A510 BRAKE MODULES AND RESISTORS



Effective: 01-01-2022
Supersedes: 07-06-2021

HEAVY DUTY



All resistor sets are not in an enclosure (chassis).

230V 3-Phase*

AC DRIVE HP RATING	BRAKING TRANSISTOR		
	MODEL NUMBER	QTY USED	LIST PRICE (\$) EACH
1	X	-	-
2	X	-	-
3	X	-	-
5	X	-	-
7.5	X	-	-
10	X	-	-
15	X	-	-
20	X	-	-
25	X	-	-
30	JNTBU-230	1	475
40	JNTBU-230	2	475
50	JNTBU-230	2	475
60	JNTBU-230	2	475
75	JNTBU-230	2	475
100	JNTBU-230	3	475

X = Transistor Built-in for all A510 drives at these ratings

230V 3-Phase*

AC DRIVE HP RATING	MODEL NUMBER	QTY USED	BRAKING RESISTOR					LIST PRICE (\$) EACH
			RESISTANCE OHMS WATTS		ENCLOSURE DIMENSIONS (in.)	BRAKING TORQUE %	DUTY CYCLE %	
1	JNBR-150W200	1	200	150	9.88"L x 1.10"W x 2.36"D	119	10	30
2	JNBR-150W100	1	100	150	9.88"L x 1.10"W x 2.36"D	119	10	35
3	JNBR-260W70	1	70	260	10.79"L x 1.34"W x 3.07"D	115	10	50
5	JNBR-390W40	1	40	390	10.79"L x 1.34"W x 3.07"D	119	10	70
7.5	JNBR-520W30	1	30	520	15.7"L x 1.57"W x 3.94"D	108	10	125
10	JNBR-780W20	1	20	780	15.7"L x 1.57"W x 3.94"D	119	10	150
15	JNBR-2R4KW13R6	1	13.6	2400	21.1"L x 1.96"W x 4.33"D	117	10	450
20	JNBR-3KW10	1	10	3000	24.21"L x 1.96"W x 4.33"D	119	10	575
25	JNBR-4R8KW8	1	8	4800	21.1"L x 1.96"W x 4.33"D	119	10	940
30	JNBR-4R8KW6R8	1	6.8	4800	21.1"L x 1.96"W x 4.33"D	117	10	955
40	JNBR-3KW10	2	10	3000	24.21"L x 1.96"W x 4.33"D	119	10	575
50	JNBR-3KW10	2	10	3000	24.21"L x 1.96"W x 4.33"D	99	10	575
60	JNBR-4R8KW6R8	2	6.8	4800	21.1"L x 1.96"W x 4.33"D	117	10	955
75	JNBR-4R8KW6R8	2	6.8	4800	21.1"L x 1.96"W x 4.33"D	98	10	955
100	JNBR-4R8KW6R8	3	6.8	4800	21.1"L x 1.96"W x 4.33"D	108	10	955

A510 BRAKE MODULES AND RESISTORS



HEAVY DUTY

Effective: 01-01-2022
Supersedes: 07-06-2021

460V 3-Phase*

AC DRIVE HP RATING	BRAKING TRANSISTOR		
	MODEL NUMBER	QTY USED	LIST PRICE (\$) EACH
1	X	-	-
2	X	-	-
3	X	-	-
5	X	-	-
7.5	X	-	-
10	X	-	-
15	X	-	-
20	X	-	-
25	X	-	-
30	X	-	-
40**	X	-	-
50	JNTBU-430	2	605
60	JNTBU-430	2	605
75	JNTBU-430	2	605
100	JNTBU-430	3	605
125	JNTBU-430	3	605
150	JNTBU-430	4	605
200	JNTBU-430	5	605
250	JNTBU-430	6	605
300	JNTBU-430	6	605
350	JNTBU-430	8	605
400	JNTBU-430	9	605

X Transistor Built-in for all A510 drives at these ratings

**Please consult factory when applying braking capabilities.

460V 3-Phase*

AC DRIVE HP RATING	MODEL NUMBER	QTY USED	BRAKING RESISTOR					
			RESISTANCE OHMS WATTS	ENCLOSURE DIMENSIONS (in.)	BRAKING TORQUE %	DUTY CYCLE %	LIST PRICE (\$) EACH	
1	JNBR-150W750	1	750	150	9.88"L x 1.10"W x 2.36"D	126	10	30
2	JNBR-150W400	1	400	150	9.88"L x 1.10"W x 2.36"D	119	10	35
3	JNBR-260W250	1	250	260	10.79"L x 1.34"W x 3.07"D	126	10	50
5	JNBR-400W150	1	150	400	10.79"L x 1.34"W x 3.07"D	126	10	75
7.5	JNBR-600W130	1	130	600	15.7"L x 1.57"W x 3.94"D	102	10	125
10	JNBR-800W100	1	100	800	24.21"L x 1.96"W x 4.33"D	99	10	150
15	JNBR-1R6KW50	1	50	1600	24.21"L x 1.96"W x 4.33"D	126	10	300
20	JNBR-1R5KW40	1	40	1500	24.21"L x 1.96"W x 4.33"D	119	10	300
25	JNBR-4R8KW32	1	32	4800	21.1"L x 1.96"W x 4.33"D	119	10	900
30	JNBR-4R8KW27R2	1	27.2	4800	21.1"L x 1.96"W x 4.33"D	117	10	900
40**	JNBR-6KW20	1	20	6000	24.21"L x 1.96"W x 4.33"D	119	10	1,100
50	JNBR-4R8KW32	2	32	4800	21.1"L x 1.96"W x 4.33"D	119	10	900
60	JNBR-4R8KW27R2	2	27.2	4800	21.1"L x 1.96"W x 4.33"D	117	10	900
75	JNBR-6KW20	2	20	6000	24.21"L x 1.96"W x 4.33"D	126	10	1,100
100	JNBR-6KW20	3	20	6000	24.21"L x 1.96"W x 4.33"D	139	10	1,100
125	JNBR-6KW20	3	20	6000	24.21"L x 1.96"W x 4.33"D	115	10	1,100
150	JNBR-6KW20	4	20	6000	24.21"L x 1.96"W x 4.33"D	125	10	1,100
200	JNBR-6KW20	5	20	6000	24.21"L x 1.96"W x 4.33"D	99	10	1,100
250	JNBR-6KW20	6	20	6000	24.21"L x 1.96"W x 4.33"D	120	10	1,100
300	JNBR-6KW20	6	20	6000	24.21"L x 1.96"W x 4.33"D	99	10	1,100
350	JNBR-6KW20	8	20	6000	24.21"L x 1.96"W x 4.33"D	105	10	1,100
400	JNBR-6KW20	9	20	6000	24.21"L x 1.96"W x 4.33"D	104	10	1,100

**Please consult factory when applying braking capabilities.

Please contact factory for external brakes, external braking transistors, and braking capabilities on 575V/690V products.

‡ Pricing for the quantity of one (1) unit

For braking applications above 100 HP at 230V or above 200 HP at 460V, please consult the factory.

For 575/690V braking units, please contact factory.

F510



FAN & PUMP

Effective: 01-01-2022

Supersedes: 07-06-2021



A versatile AC drive that is easily configured and handles almost any fan, blower, or centrifugal pump application.

APPLICATIONS:

- Fans
- Blowers
- Water and Wastewater Industries
- Centrifugal Pumps
- HVAC Industries
- Irrigation

FEATURES:

- Built-in PLC as Standard
- Operation and Engineering Units Standard
- LCD Keypad with Remote Mounting Capabilities
- PID Control with Advanced Diagnostics and Sleep Mode
- 1 to 150 HP (Variable Torque), 230V, 50/ 60Hz, 3-Phase
- 1 to 800 HP (Variable Torque), 460V, 50/ 60Hz, 3-Phase
- Plenum Rated
- Diagnostics Registers for Troubleshooting
- Flexible Input/ Output Configurations that Incorporate Normally Open or Normally Closed Signals
- 0 to 400 Hz Speed Range
- Built-in Modbus, BACnet, and Metasys (N2) Protocols via (RS485 or RJ45 Interface)
- Enhanced Design for Smoother and Quieter Motor Operation
- Real Time Clock (Standard on Models with LCD Keypad)
- PTC Input Available for Direct Thermal Protection of the Motor
- Thermal Management on the Heat Sink for Overtemperature Fault Avoidance
- Master-Follower Control Mode Built-in
- EMI Protection that Complies with EM61800-3 with Optional Filter
- EMS Protection that Follows EN61800-3
- UL, cUL, and CE Approved

F510



FAN & PUMP

Effective: 01-01-2022
Supersedes: 07-06-2021



230V 3-Phase

MODEL NO.	VARIABLE TORQUE		DIMENSIONS (in.)			APPROX. WT. (lbs.)	CONTROL LIST PRICE (\$)
	HP	DRIVE AMPS	HEIGHT	WIDTH	DEPTH		
‡ *JNF510-2001-C-UE	1	5.0	9.61	5.12	5.91	6	628
‡ *JNF510-2002-C-UE	2	7.5	9.61	5.12	5.91	6	670
‡ *JNF510-2003-C-UE	3	10.6	9.61	5.12	5.91	6	700
*JNF510-2005-C3-UE	5	14.5	12.4	5.51	6.97	8.4	855
*JNF510-2008-C3-UE	7.5	21.0	12.4	5.51	6.97	8.4	876
*JNF510-2010-C3-UE	10	30.0	11.81	8.27	8.46	13.6	1,246
*JNF510-2015-C3-UE	15	40.0	11.81	8.27	8.46	13.6	1,380
*JNF510-2020-C3-UE	20	56.0	14.17	10.43	8.86	22	1,730
*JNF510-2025-C3-UE	25	69.0	14.17	10.43	8.86	22	2,163
*JNF510-2030-C3-UE	30	79.0	14.17	10.43	8.86	22	2,781
JNF510-2040-C3-UE	40	110.0	20.67	11.18	9.92	66.1	3,790
**JNF510-2050-C3-UE	50	138.0	20.67	11.18	9.92	66.1	4,439
**JNF510-2060-C3-UE	60	169.0	22.83	13.54	11.81	89.3	6,736
**JNF510-2075-C3-UE	75	200.0	22.83	13.54	11.81	89.3	7,395
**JNF510-2100-C3-UE	100	250.0	31.10	18.08	12.78	162.8	9,692
**JNF510-2125-C3-UE	125	312.0	31.10	18.08	12.78	162.8	12,113
**JNF510-2150-C3-UE	150	400.0	39.37	27.16	16.14	405	24,226

460V 3-Phase Input

MODEL NO.	VARIABLE TORQUE		DIMENSIONS (in.)			APPROX. WT. (lbs.)	CONTROL LIST PRICE (\$)
	HP	DRIVE AMPS	HEIGHT	WIDTH	DEPTH		
*JNF510-4001-C3-UE	1	3.4	9.61	5.12	5.91	6	649
*JNF510-4002-C3-UE	2	4.1	9.61	5.12	5.91	6	690
*JNF510-4003-C3-UE	3	5.4	9.61	5.12	5.91	6	690
*JNF510-4005-C3-UE	5	9.2	12.4	5.51	6.97	8.8	834
*JNF510-4008-C3-UE	7.5	11.1	12.4	5.51	6.97	8.8	927
*JNF510-4010-C3-UE	10	17.5	12.4	5.51	6.97	8.8	1,349
*JNF510-4015-C3-UE	15	23.0	11.81	8.27	8.46	13.6	1,514
*JNF510-4020-C3-UE	20	31.0	11.81	8.27	8.46	13.6	1,854
*JNF510-4025-C3-UE	25	38.0	14.17	10.43	8.86	22	2,184
*JNF510-4030-C3-UE	30	44.0	14.17	10.43	8.86	22	2,719
*JNF510-4040-C3-UE	40	54.0	14.17	10.43	8.86	22	2,925
JNF510-4050-C3-UE	50	72.0	20.67	11.18	9.92	66.1	3,729
JNF510-4060-C3-UE	60	88.0	20.67	11.18	9.92	66.1	4,656
JNF510-4075-C3-UE	75	103.0	20.67	11.18	9.92	66.1	5,109
**JNF510-4100-C3-UE	100	145.0	22.83	13.7	11.81	89.3	6,479
**JNF510-4125-C3-UE	125	165.0	22.83	13.7	11.81	89.3	9,806
**JNF510-4150-C3-UE	150	208.0	31.10	18.08	12.78	163.1	13,586
**JNF510-4215-C3-UE	200	250.0	31.10	18.08	12.78	163.1	17,819
**JNF510-4250-C3-UE	250	328.0	31.10	18.08	12.78	163.1	19,137
**JNF510-4300-C3-UE	300	435.0	39.37	27.16	16.14	405	23,463
**JNF510-4375-C3-UE	350	515.0	39.37	27.16	16.14	405	25,379
**JNF510-4425-C3-UE	400	585.0	39.37	27.16	16.14	405	28,490
***JNF510-4535-C3-UE	500	690.0	53.38	37.79	19.96	640	63,448
***JNF510-4670-C3-UE	600/650	840.0	53.38	37.79	19.96	640	72,677
***JNF510-4800-C3-UE	800	960.0	53.38	37.79	19.96	640	80,402

* Includes Dynamic Braking Transistor

** Includes DC Bus Link Reactor

*** External DC Link Reactor

‡ Operates on single or three phase inputs at specified rating

NOTE: 1-40 HP, NEMA 1, 230 V, 50 HP & above, protected chassis; 1-75 HP, NEMA 1, 460 V, 100HP and above, protected chassis

F510 OPTIONS



Effective: 01-01-2022
 Supersedes: 07-06-2021

FAN & PUMP



OPTION PART NUMBER	DESCRIPTION	LIST PRICE (\$)
JN5-CB-01M	Remote Wire for Keypad (1M)	25
JN5-CB-02M	Remote Wire for Keypad (2M)	27
JN5-CB-03M	Remote Wire for Keypad (3M)	30
JN5-CB-05M	Remote Wire for Keypad (5M)	35
JN5-CM-PDP	PROFIBUS Communication Interface Module	350
JN5-CM-USB	USB Cable to Connect PC	80
JN5-CU	Copy Module (ONLY)	95
JN5-NK-A06	F510 Frame 6 NEMA1 KIT 60, 75HP 230V; 100,125HP 460V	475
JN5-NK-A07	F510 Frame 7 NEMA1 KIT 100,125HP 230V; 150,200,250HP 460V	690
JN5-NK-A08	F510 Frame 8 NEMA1 KIT 150HP 230V,300,350,400HP 460V	710
JN5-NK-A09	F510 Frame 9 NEMA1 KIT 500,600/650,800HP 460V	920
E015	NEMA 1 KITS FOR DC LINK 500-800HP	3,800
JN5-OP-F01	LED Operator	75
4KA41S1139T01	LCD Operator Replacement*	148
JN5-OP-A03	Blank Operator	25
JN5-IO-8DO	1 to 8 Pump Card	150
JN5-IO-2DO1AI	Digital&Analog IO Expansion Card	275
JN5-MD-A01	Middle Layer Case for Frame1*	42
JN5-MD-A02	Middle Layer Case for Frame2**	50
JN5-MD-A03	Middle Layer Case for Frame3**	55
JN5-MD-A04	Middle Layer Case for Frame4**	59

***LCD Operator is standard on all F510 models.**

*Note Frame 1: Middle layer case is required when using plug-in option cards.

** Note Frame 2~4: Middle layer case is only required when using 2 plug-in option cards.

F510 BRAKE MODULES AND RESISTORS



Effective: 01-01-2022
Supersedes: 07-06-2021



All resistor sets are not in an enclosure (chassis).

460V 3-Phase*

AC DRIVE HP RATING	BRAKING TRANSISTOR		
	MODEL NUMBER	QTY USED	LIST PRICE (\$) EACH
1	X	-	-
2	X	-	-
3	X	-	-
5	X	-	-
7.5	X	-	-
10	X	-	-
15	X	-	-
20	X	-	-
25	X	-	-
30	X	-	-
40	JNTBU-230	2	475
50	JNTBU-230	2	475
60	JNTBU-230	2	475
75	JNTBU-230	3	475
100	JNTBU-230	3	475
125	JNTBU-230	4	475
150	JNTBU-230	5	475
200	JNTBU-430	5	605
250	JNTBU-430	6	605
300	JNTBU-430	6	605
350	JNTBU-430	8	605
400	JNTBU-430	9	605

X = Transistor Built-in for all E510 drives at these ratings

460V 3-Phase*

AC DRIVE HP RATING	BRAKING RESISTOR							
	MODEL NUMBER	QTY USED	RESISTANCE OHMS WATTS		ENCLOSURE DIMENSIONS (in.)	BRAKING TORQUE %	DUTY CYCLE %	LIST PRICE (\$) EACH
1	JNBR-150W200	1	200	150	9.88"L x 1.10"W x 2.36"D	119	10	30
2	JNBR-150W100	1	100	150	9.88"L x 1.10"W x 2.36"D	119	10	35
3	JNBR-260W70	1	70	260	10.79"L x 1.34"W x 3.07"D	115	10	50
5	JNBR-390W40	1	40	390	10.79"L x 1.34"W x 3.07"D	126	10	70
7.5	JNBR-520W30	1	30	520	15.7"L x 1.57"W x 3.94"D	114	10	125
10	JNBR-780W20	1	20	780	15.7"L x 1.57"W x 3.94"D	126	10	150
15	JNBR-2R4KW13R6	1	13.6	2400	21.1"L x 1.96"W x 4.33"D	124	10	450
20	JNBR-3KW10	1	10	3000	24.21"L x 1.96"W x 4.33"D	126	10	575
25	JNBR-4R8KW8	1	8	4800	21.1"L x 1.96"W x 4.33"D	126	10	940
30	JNBR-4R8KW6R8	1	6.8	4800	21.1"L x 1.96"W x 4.33"D	124	10	955
40	JNBR-3KW10	2	10	3000	24.21"L x 1.96"W x 4.33"D	126	10	575
50	JNBR-3KW10	2	10	3000	24.21"L x 1.96"W x 4.33"D	105	10	575
60	JNBR-4R8KW6R8	2	6.8	4800	21.1"L x 1.96"W x 4.33"D	124	10	955
75	JNBR-4R8KW6R8	3	6.8	4800	21.1"L x 1.96"W x 4.33"D	124	10	955
100	JNBR-4R8KW6R8	3	6.8	4800	21.1"L x 1.96"W x 4.33"D	116	10	955
125	JNBR-4R8KW6R8	4	6.8	4800	21.1"L x 1.96"W x 4.33"D	119	10	955
150	JNBR-4R8KW6R8	5	6.8	4800	21.1"L x 1.96"W x 4.33"D	108	10	955

F510 BRAKE MODULES AND RESISTORS



Effective: 01-01-2022
Supersedes: 07-06-2021

460V 3-Phase*

AC DRIVE HP RATING	BRAKING TRANSISTOR		
	MODEL NUMBER	QTY USED	LIST PRICE (\$) EACH
1	X	-	-
2	X	-	-
3	X	-	-
5	X	-	-
7.5	X	-	-
10	X	-	-
15	X	-	-
20	X	-	-
25	X	-	-
30	X	-	-
40	X	-	-
50	JNTBU-430	2	605
60	JNTBU-430	2	605
75	JNTBU-430	2	605
100	JNTBU-430	3	605
125	JNTBU-430	3	605
150	JNTBU-430	4	605
200	JNTBU-430	5	605
250	JNTBU-430	5	605
300	JNTBU-430	6	605
350	JNTBU-430	8	605
400	JNTBU-430	9	605
500	JNTBU-430	10	605
600	JNTBU-430	11	605
650	JNTBU-430	11	605
800	JNTBU-430	13	605

X = Transistor Built-in for all F510 Drives at these ratings

* Pricing for the quantity of one (1) unit

‡ = All brake modules and resistors are chassis style not in a enclosure

460V 3-Phase*

AC DRIVE HP RATING	BRAKING RESISTOR							
	MODEL NUMBER	QTY USED	RESISTANCE OHMS WATTS		ENCLOSURE DIMENSIONS (in.)	BRAKING TORQUE %	DUTY CYCLE %	LIST PRICE (\$) EACH
1	JNBR-150W750	1	750	150	9.88"L x 1.10"W x 2.36"D	126	10	30
2	JNBR-150W400	1	400	150	9.88"L x 1.10"W x 2.36"D	119	10	35
3	JNBR-260W250	1	250	260	10.79"L x 1.34"W x 3.07"D	126	10	50
5	JNBR-400W150	1	150	400	10.79"L x 1.34"W x 3.07"D	133	10	75
7.5	JNBR-600W130	1	130	600	15.7"L x 1.57"W x 3.94"D	107	10	125
10	JNBR-800W100	1	100	800	24.21"L x 1.96"W x 4.33"D	105	10	150
15	JNBR-1R6KW50	1	50	1600	24.21"L x 1.96"W x 4.33"D	133	10	300
20	JNBR-1R5KW40	1	40	1500	24.21"L x 1.96"W x 4.33"D	126	10	300
25	JNBR-4R8KW32	1	32	4800	21.1"L x 1.96"W x 4.33"D	126	10	900
30	JNBR-4R8KW27R2	1	27.2	4800	21.1"L x 1.96"W x 4.33"D	124	10	900
40	JNBR-6KW20	1	20	6000	24.21"L x 1.96"W x 4.33"D	124	10	1,100
50	JNBR-4R8KW32	2	32	4800	21.1"L x 1.96"W x 4.33"D	126	10	900
60	JNBR-4R8KW27R2	2	27.2	4800	21.1"L x 1.96"W x 4.33"D	124	10	900
75	JNBR-6KW20	2	20	6000	24.21"L x 1.96"W x 4.33"D	133	10	1,100
100	JNBR-6KW20	3	27.2	4800	21.1"L x 1.96"W x 4.33"D	113	10	1,100
125	JNBR-6KW20	3	20	6000	24.21"L x 1.96"W x 4.33"D	121	10	1,100
150	JNBR-6KW20	4	20	6000	24.21"L x 1.96"W x 4.33"D	104	10	1,100
200	JNBR-6KW20	5	27.2	4800	21.1"L x 1.96"W x 4.33"D	107	10	1,100
250	JNBR-6KW20	5	20	6000	24.21"L x 1.96"W x 4.33"D	105	10	1,100
300	JNBR-6KW20	6	20	6000	24.21"L x 1.96"W x 4.33"D	99	10	1,100
350	JNBR-6KW20	8	20	6000	24.21"L x 1.96"W x 4.33"D	105	10	1,100
400	JNBR-6KW20	9	20	6000	24.21"L x 1.96"W x 4.33"D	104	10	1,100
500	JNBR-6KW20	10	20	6000	24.21"L x 1.96"W x 4.33"D	96	10	1,100
600	JNBR-6KW20	11	20	6000	24.21"L x 1.96"W x 4.33"D	87	10	1,100
650	JNBR-6KW20	11	20	6000	24.21"L x 1.96"W x 4.33"D	87	10	1,100
800	JNBR-6KW20	13	20	6000	24.21"L x 1.96"W x 4.33"D	86	10	1,100



A rugged and versatile drive with a wide range of ratings ideal for both simpler and more demanding applications.

APPLICATIONS:

- Crushers, Grinders
- Compressors
- Reciprocating Machinery
- Dynamometers
- Water / Wastewater Industries
- Injection Molding
- Centrifugal Pumps
- Positive Displacement Pumps
- High Torque Mixing
- Material Handling
- Extruders
- Chillers and Refrigeration
- Fans

FEATURES:

- Designed for Constant / Variable Torque Applications
- V/F, Dynamic Torque, Sensorless and Sensor (Encoder Feedback) Vector mode
- Backlit LCD / English Language with LED Monitor Display / Selections for 6 Languages
- Keypad May be Used as Copy Unit / Remote Mounting Options
- Extensive Diagnostic Information on LCD Display
- State-of-the-Art Torque Limit and Control Features
- PID Control with Sleep Mode Function
- Provided with low-noise control power supply
- 1 to 125 HP @ 230V (Constant Torque)
- 1 to 150 HP @ 230V (Variable Torque)
- 1 to 900 HP @ 460V (Constant Torque)
- 1 to 1000 HP @ 460V (Variable Torque)
- Extensive I/O Capabilities
- Encoder Feedback Option for Applications Requiring Precise Speed Control
- Conformal Coating on PC Boards, Tin Plating on DC Bus
- External Mounting of Heatsink When Installed in Control Panels (>40 HP); Option Kit Available (<= 40 HP)
- All Units are IP20 at 40hp and below and IP00 at ratings >40HP (NEMA 1 Option Kits Available)
- Built-in RS485 Protocol (Modbus)/ Options Profbus-DP, DeviceNet, EtherNet
- DC Link Chokes Included in 75 HP and Above Units are Shipped Loose as Chassis Item Inside Crate
- UL and CE Approved

MULTIPLE DUTY

 Effective: 01-01-2022
 Supersedes: 07-06-2021

230V 3-Phase Input/ 3-Phase Output ***

MODEL NO.	HP		DRIVE AMPS		APPROXIMATE DIMENSIONS (in.)			APPROX. WT. (lbs.)	CONTROL LIST PRICE (\$)
	VARIABLE TORQUE	CONSTANT TORQUE	VARIABLE TORQUE	CONSTANT TORQUE	HEIGHT	WIDTH	DEPTH		
V:EQ7-2001-C ‡	1.00	1.00	5	5	10.24	4.33	5.71	6	979
V:EQ7-2002-C ‡	2.00	2.00	8	8	10.24	5.91	5.71	9	1,112
V:EQ7-2003-C ‡	3.00	3.00	11	11	10.24	5.91	5.71	9	1,215
V:EQ7-2005-C ‡	5.00	5.00	18	18	10.24	5.91	5.71	9	1,391
V:EQ7-2007-C ‡	7.50	7.50	27	27	10.24	8.66	7.68	18	1,730
V:EQ7-2010-C ‡	10.0	7.50	29	27	10.24	8.66	7.68	18	1,833
V:EQ7-2015-C ‡	15.0	10.0	42	37	10.24	8.66	7.68	18	1,947
V:EQ7-2020-C ‡	20.0	15.0	55	49	10.24	8.66	7.68	18	2,235
V:EQ7-2025-C ‡	25.0	20.0	68	63	15.75	9.84	7.68	25	2,678
V:EQ7-2030-C ‡	30.0	25.0	80	76	15.75	9.84	7.68	25	3,193
V:EQ7-2040-C ‡	40.0	30.0	107	90	15.75	12.6	7.68	25	4,069
V:EQ7-2050-C	50.0	40.0	146	119	21.65	14.0	10.0	86	6,726
V:EQ7-2060-C	60.0	50.0	180	146	24.21	14.8	10.6	104	7,725
V:EQ7-2075-C	75.0	60.0	215	180	29.13	14.0	10.6	123	9,013
V:EQ7-2100-C	100	75.0	283	215	29.13	14.0	10.6	163	10,377
V:EQ7-2125-C	125	100	346	283	29.53	20.9	11.2	234	14,935
V:EQ7-2150-C	150	125	415	346	34.65	24.8	14.2	348	19,261

460V 3-Phase Input/ 3-Phase Output

MODEL NO.	HP		DRIVE AMPS		APPROXIMATE DIMENSIONS (Inches)			APPROX. WT. (lbs.)	LIST PRICE (\$)
	VARIABLE TORQUE	CONSTANT TORQUE	VARIABLE TORQUE	CONSTANT TORQUE	HEIGHT	WIDTH	DEPTH		
V:EQ7-4001-C ‡	1.00	1.00	2.5	2.50	10.24	4.33	5.71	6	937
V:EQ7-4002-C ‡	2.00	2.00	4.0	4.00	10.24	5.91	5.71	9	1,035
V:EQ7-4003-C ‡	3.00	3.00	5.5	5.50	10.24	5.91	5.71	9	1,236
V:EQ7-4005-C ‡	5.00	5.00	9.0	9.00	10.24	5.91	5.71	9	1,360
V:EQ7-4007-C ‡	7.50	7.50	13.5	13.5	10.24	8.66	7.68	18	1,906
V:EQ7-4010-C ‡	10.0	7.50	16.5	13.5	10.24	8.66	7.68	18	1,988
V:EQ7-4015-C ‡	15.0	10.0	23	18.5	10.24	8.66	7.68	18	2,034
V:EQ7-4020-C ‡	20.0	15.0	30.5	24.5	10.24	8.66	7.68	18	2,348
V:EQ7-4025-C ‡	25.0	20.0	37	32.0	15.75	9.84	7.68	25	2,565
V:EQ7-4030-C ‡	30.0	25.0	45	39.0	15.75	9.84	7.68	25	3,219
V:EQ7-4040-C ‡	40.0	30.0	60	45.0	15.75	9.84	7.68	25	4,510
V:EQ7-4050-C	50.0	40.0	75	60.0	21.65	12.6	10.04	82	5,758
V:EQ7-4060-C	60.0	50.0	91	75.0	21.65	12.6	10.04	82	7,107
V:EQ7-4075-C	75.0	60.0	112	91.0	24.21	13.98	10.63	97	7,416
V:EQ7-4100-C	100	75.0	150	112	26.57	13.98	10.63	143	9,476
V:EQ7-4125-C	125	100	176	150	29.13	13.98	10.63	168	11,742
V:EQ7-4150-C*	150	125/150	210	210**	29.13	20.87	12.40	243	14,976
V:EQ7-4200-C*	200	200	253	253**	29.13	20.87	12.40	243	15,965
V:EQ7-4250-C*	250	250	304	304**	39.37	20.87	14.17	320	19,776
V:EQ7-4300-C*	300	300	377	377**	39.37	20.87	14.17	335	21,836
V:EQ7-4350-C*	350	350	415	415**	39.37	26.77	14.17	423	25,647
V:EQ7-4450-C*	400/450	350	520	468**	39.37	26.77	14.17	443	30,385
V:EQ7-4500-C*	500	400/450	650	585**	55.12	26.77	17.32	966	58,710
V:EQ7-4600-C*	600	500	740	650**	55.12	26.77	17.32	1014	61,342
V:EQ7-4700-C*	700	600	840	740**	55.12	34.68	17.32	1241	73,130
V:EQ7-4800-C*	800	700	960	840**	55.12	34.68	17.32	1252	76,169
V:EQ7-4900-C	900	800	1170	960	61.02	39.37	19.69	1886	131,840
V:EQ7-41000-C	1000	900	1370	1170	61.02	39.37	19.69	1931	141,419

Notes:

- * Marked items are suitable for constant torque V/F control.
- ** Please consult factory for vector control full load amps for these items.
- *** Do Not Apply Single Phase Input Power to these Models
- ‡ Dynamic braking transistor built-in

EQ7 PERIPHERALS



MULTIPLE DUTY

Effective: 01-01-2022
Supercedes: 07-06-2021



OPTION TYPE	MODEL	DESCRIPTION	LIST PRICE (\$)
NEMA1 Kit	NEMA1-0.75G1-24	1HP 230V,460V	50
	NEMA1-3.75G1-24	2,3,5HP 230V,460V	65
	NEMA1-11G1-24	7.5,10,15,20HP 230V,460V	110
	NEMA1-22G1-24	25,30HP 230V, 25,30,40HP 460V	130
	NEMA1-22G1-2	40HP 230V	150
	NEMA1-37G1-24	50HP, 230V,50,60HP 460V	800
	NEMA1-75G1-24	60,75,100HP 230V, 75,100,125HP 460V	1,050
	NEMA1-75G1-2	125HP 230V	1,615
	NEMA1-110G1-4	150,200HP 460V	1,400
	NEMA1-160G1-4	250,300HP 460V	1,725
	NEMA1-220G1-24	150HP 230V, 350,450HP 460V	1,800
	NEMA1-315G1-4	500,600HP 460V	1,100
	NEMA1-400G1-4	700,800HP 460V	1,275
NEMA1-630G1-4	900,1000HP 460V	2,100	
DC Bus Choke UL Type 1 Enclosure	E012	100,125,150HP 230V,100 HP 460V	625
	E013	125 - 350 HP 460V	1,150
	E014	450 - 700 HP 460V	2,400
	E015	800 - 1000 HP 460V	3,800
Braking Unit	BU37-2C	230V 50HP - 60HP	1,675
	BU55-2C	230V 75HP - 100HP	2,200
	BU90-2C	230V 125 - 150HP	3,040
	BU37-4C	460V 50HP - 60HP	1,726
	BU55-4C	460V 75HP - 100HP	2,325
	BU90-4E	460V 125HP - 150HP	3,040
	BU132-4C	460V 200HP - 250HP	4,175
BU220-4C	460V 300HP - 450HP CONSULT FACTORY for applications above 450HP	6,075	
Braking Resistor	DB0.75-2C	230V 1HP and below	100
	DB2.2-2C	230V 2HP - 3HP	125
	DB3.7-2C	230V 5HP	175
	DB5.5-2C	230V 7.5,10HP	265
	DB7.5-2C	230V 15HP	307
	DB11-2C	230V 20HP	388
	DB15-2C	230V 25HP	555
	DB22-2C	230V 30HP - 40HP	915
	DB30-2C	230V 50HP	1,432
	DB37-2C	230V 60HP	1,850

OPTION TYPE	MODEL	DESCRIPTION	LIST PRICE (\$)
Braking Resistor	DB45-2C	230V 75HP	2,265
	DB55-2C	230V 100HP	2,450
	DB75-2C	230V 125HP	3,800
	DB90-2C	230V 150HP	4,200
	DB0.75-4C	460V 1HP	129
	DB2.2-4C	460V 2HP - 3HP	134
	DB3.7-4C	460V 7.5HP	199
	DB5.5-4C	460V 10HP	263
	DB7.5-4C	460V 15HP	308
	DB11-4C	460V 20HP	429
	DB15-4C	460V 25HP	590
	DB22-4C	460V 30HP - 40HP	978
	DB30-4C	460V 50HP	1,163
	DB37-4C	460V 60HP	1,873
	DB45-4C	460V 75HP	2,156
	DB55-4C	460V 100HP	1,854
	DB75-4C	460V 125HP	3,290
	DB110-4C	460V 150HP - 200HP	3,755
	DB132-4C	460V 250HP	4,500
	DB160-4C	460V 300HP	5,425
DB200-4C	460V 350HP	5,900	
DB220-4C	460V 400HP - 450HP CONSULT FACTORY for applications above 450HP	7,540	
Options and Accessories	OPC-G1-DEV	DeviceNet card	1,350
	OPC-G1-CCL	CC-link card	1,200
	OPC-G1-PDP2	PROFIBUS-DP card	1,500
	OPC-PRT2	PROFINET card	1,000
	OPC-G1-COP	CANopen	1,800
	OPC-G1-TL	T-link interface card	1,105
	OPC-G1-PG	PG interface card (12V)	190
	OPC-G1-PG2	PG interface card (5V)	225
	OPC-G1-PG22	PG Synchronization card	470
	OPC-G1-DI	Digital input interface card	495
	OPC-G1-DO	Digital output interface card	495
	OPC-G1-AIO	Analog input/output interface card	500
	OPC-G1-RY	Relay communication card	140
TP-G1W-J1	Standard Keypad (LCD)	450	
TP-E1 U	Keypad (with USB Port) LED Only	130	
Keypad Extension Cable	EQ7-3S	3 ft, Cable	60
	JN5-CB-05M	Remote Wire for Keypad (5M)	35

Notes:

(1) HP indication of Braking Unit & Braking Resistor are for VT HP of dual rating drives. Conditions are the same as drive.

LINE REACTORS



230V

Effective: 01-01-2022
Supersedes: 07-06-2021

Low priced and easy to install, Line Reactors provide input transient protection from harmonic distortion. When applying a reactor between the drive output and the motor, please contact the Factory.

3% IMPEDANCE, 230V

HP	AMPS	ULCHASSIS UNIT				UL TYPE 1 ENCLOSURE			
		PRODUCT CODE	DIMENSIONS W x H x D (in.)	WEIGHT (lbs.)	CONTROL LIST PRICE (\$)	MODEL NO.	DIMENSIONS H x W x D (in.)	WEIGHT (lbs.)	CONTROL LIST PRICE (\$)
1	5.5	KDRMA24L1	4.45 x 3.63 x 1.78	1.20	246	KDRMA24L1E01	12.5 x 12.25 x 6.75	11.6	684
1.5	8	KDRMA25L1	4.45 x 3.63 x 1.78	1.20	257	KDRMA25L1E01	12.5 x 12.25 x 6.75	11.6	690
2	10	KDRMA27L1	4.45 x 3.63 x 1.78	1.30	267	KDRMA27L1E01	12.5 x 12.25 x 6.75	11.7	702
3	12	KDRAA28L2	4.25 x 4.44 x 2.64	3.00	276	KDRAA28L2E01	12.5 x 12.25 x 6.75	13.4	729
5	19	KDRB22L	6 x 5 x 4	8.00	312	KDRB22LE01	12.5 x 12.25 x 6.75	18.4	759
7.5	25	KDRB23L	6 x 5 x 4	8.00	336	KDRB23LE01	12.5 x 12.25 x 6.75	18.4	765
10	34	KDRD25L	7.2 x 5.75 x 4.25	12.0	351	KDRD25LE01	12.5 x 12.25 x 6.75	22.4	776
15	48	KDRD24L	7.2 x 5.75 x 4.25	12.0	372	KDRD24LE01	12.5 x 12.25 x 6.75	22.4	784
20	62	KDRD26L	7.2 x 5.75 x 4.25	12.0	397	KDRD26LE01	12.5 x 12.25 x 6.75	22.4	810
25	80	KDRC22L	7.2 x 5.75 x 5	15.0	601	KDRC22LE01	12.5 x 12.25 x 6.75	25.4	884
30	100	KDRF24L	9 x 7 x 7	30.0	640	KDRF24LE01	15.43 x 19.13 x 15.43	67.0	1,190
40	118	KDRF25L	9 x 7 x 7	30.0	895	KDRF25LE01	15.43 x 19.13 x 15.43	67.0	1,445
50	152	KDRF26L	9 x 7 x 7	30.0	1,043	KDRF26LE01	15.43 x 19.13 x 15.43	67.0	1,587
60	180	KDRH22L	11 x 9 x 7	45.0	1,202	KDRH22LE01	20.43 x 22.12 x 24.37	112	2,211
75	211	KDRI23L	11 x 9 x 7	50.0	1,239	KDRI23LE01	20.43 x 22.12 x 24.37	116	2,268
100	280	KDRI24L	11 x 9 x 7	50.0	1,361	KDRI24LE01	20.43 x 22.12 x 24.37	116	2,382
125	377	KDRG22L	11 x 9 x 8	65.0	1,900	KDRG22LE01	20.43 x 22.12 x 24.37	132	2,948
150	420	KDRJ23L	11 x 9 x 9	70.0	2,098	KDRJ23LE01	20.43 x 22.12 x 24.37	136	3,153

5% IMPEDANCE, 230V

HP	AMPS	ULCHASSIS UNIT				UL TYPE 1 ENCLOSURE			
		PRODUCT CODE	DIMENSIONS W x H x D (in.)	WEIGHT (lbs.)	CONTROL LIST PRICE (\$)	MODEL NO.	DIMENSIONS H x W x D (in.)	WEIGHT (lbs.)	CONTROL LIST PRICE (\$)
1	5	KDRMA24H1	4.45 x 3.63 x 1.78	1.20	265	KDRMA24H1E01	12.5 x 12.25 x 6.75	11.6	719
1.5	7.5	KDRMA25H1	4.45 x 3.63 x 1.78	1.50	287	KDRMA25H1E01	12.5 x 12.25 x 6.75	11.9	744
2	10	KDRMA26H1	4.45 x 3.63 x 1.78	1.50	299	KDRMA26H1E01	12.5 x 12.25 x 6.75	11.9	754
3	11	KDRAA28H2	4.25 x 4.44 x 2.64	2.60	330	KDRAA28H2E01	12.5 x 12.25 x 6.75	13.0	781
5	17	KDRB25H	6 x 5 x 4	8.00	336	KDRB25HE01	12.5 x 12.25 x 6.75	18.4	782
7.5	26	KDRB26H	6 x 5 x 4	8.00	352	KDRB26HE01	12.5 x 12.25 x 6.75	18.4	784
10	31	KDRD21H	7 x 5.75 x 4.25	12.0	360	KDRD21HE01	12.5 x 12.25 x 6.75	22.4	785
15	47	KDRD22H	7.2 x 5.75 x 4.25	12.0	472	KDRD22HE01	12.5 x 12.25 x 6.75	22.4	788
20	62	KDRC22H	7.5 x 5.75 x 5	15.0	535	KDRC22HE01	12.5 x 12.25 x 6.75	25.4	873
25	75	KDRF28H	9 x 7 x 6	30.0	644	KDRF28HE01	15.43 x 19.13 x 15.43	67.0	1,271
30	92	KDRF25H	9 x 7 x 7	30.0	732	KDRF25HE01	15.43 x 19.13 x 15.43	67.0	1,389
40	114	KDRF26H	9 x 7 x 7	30.0	953	KDRF26HE01	15.43 x 19.13 x 15.43	67.0	1,576
50	143	KDRH24H	11 x 9 x 7	38.0	1,157	KDRH24HE01	15.43 x 19.13 x 15.43	75.0	1,758
60	169	KDRH23H	11 x 9 x 7	45.0	1,332	KDRH23HE01	15.43 x 19.13 x 15.43	82.0	2,240
75	220	KDRI22H	11 x 9 x 7	50.0	1,667	KDRI22HE01	20.43 x 22.12 x 24.37	116	2,779
100	275	KDRI21H	11 x 9 x 7	50.0	2,019	KDRI21HE01	20.43 x 22.12 x 24.37	116	3,119
125	350	KDRG25H	11 x 9 x 8	65.0	2,069	KDRG25HE01	20.43 x 22.12 x 24.37	132	3,203
150	412	KDRJ22H	11 x 9 x 9	70.0	2,240	KDRJ22HE01	20.43 x 22.12 x 24.37	136	3,329

Notes:

* Base Plate if needed order Part # AP03

LINE REACTORS



460V

Effective: 01-01-2022
Supersedes: 07-06-2021

3% IMPEDANCE, 460V

HP	AMPS	CHASSIS UNIT				UL TYPE 1 ENCLOSURE			
		PRODUCT CODE	DIMENSIONS W x H x D (in.)	WEIGHT (lbs.)	CONTROL LIST PRICE (\$)	PRODUCT CODE	DIMENSIONS W x H x D (in.)	WEIGHT (lbs.)	CONTROL LIST PRICE (\$)
1	2.3	KDRMA5L1	4.45 x 3.63 x 1.78	1.2	168	KDRMA5L1E01	12.5 x 12.25 x 6.75	11.6	438
2	4.2	KDRMA7L1	4.45 x 3.63 x 1.78	1.4	187	KDRMA7L1E01	12.5 x 12.25 x 6.75	11.8	457
3	5	KDRMA8L1	4.45 x 3.63 x 1.78	1.4	204	KDRMA8L1E01	12.5 x 12.25 x 6.75	11.8	475
5	8.2	KDRAA3L2	4.25 x 4.44 x 2.64	3.0	227	KDRAA3L2E01	12.5 x 12.25 x 6.75	13.4	495
7.5	11	KDRAA4L2	4.25 x 4.44 x 2.64	3.2	230	KDRAA4L2E01	12.5 x 12.25 x 6.75	13.6	499
10	14	KDRAA5L2	4.25 x 4.44 x 2.64	3.3	389	KDRAA5L2E01	12.5 x 12.25 x 6.75	13.7	844
15	30	KDRB2L	6 x 5 x 4	8.0	392	KDRB2LE01	12.5 x 12.25 x 6.75	18.4	847
20	30	KDRB1L	6 x 5 x 4	8.0	413	KDRB1LE01	12.5 x 12.25 x 6.75	18.4	879
25	50	KDRD1L	7.2 x 5.75 x 4.25	10.0	440	KDRD1LE01	12.5 x 12.25 x 6.75	20.4	923
30	45	KDRD2L	7.2 x 5.75 x 4.25	10.0	476	KDRD2LE01	12.5 x 12.25 x 6.75	20.4	989
40	55	KDRC1L	7.2 x 5.75 x 5	15.0	527	KDRC1LE01	12.5 x 12.25 x 6.75	25.4	996
50	65	KDRF2L	9 x 7 x 6	25.0	624	KDRF2LE01	15.43 x 19.13 x 15.43	62.0	1,275
60	77	KDRF4L	9 x 7 x 6	25.0	652	KDRF4LE01	15.43 x 19.13 x 15.43	62.0	1,293
75	110	KDRF3L	9 x 7 x 7	30.0	960	KDRF3LE01	15.43 x 19.13 x 15.43	67.0	1,605
100	150	KDRH3L	11 x 7 x 7	40.0	1,108	KDRH3LE01	15.43 x 19.13 x 15.43	77.0	1,747
125	165	KDRH2L	11 x 9 x 7	40.0	1,327	KDRH2LE01	15.43 x 19.13 x 15.43	77.0	1,977
150	185	KDRH1L	11 x 9 x 7	40.0	1,537	KDRH1LE01	20.43 x 22.12 x 24.37	106	2,779
200	240	KDRG3L	11 x 9 x 8	65.0	2,030	KDRG3LE01	20.43 x 22.12 x 24.37	131	3,156
250	340	KDRG1L	11 x 9 x 8	65.0	2,189	KDRG1LE01	20.43 x 22.12 x 24.37	132	3,368
300	370	KDRG2L	11 x 9 x 8	65.0	2,279	KDRG2LE01	20.43 x 22.12 x 24.37	132	3,402
350	500	KDRJ2L	11 x 9 x 9	70.0	2,642	KDRJ2LE01	20.43 x 22.12 x 24.37	136	3,884
400	520	KDRJ1L	11 x 9 x 9	70.0	2,937	KDRJ1LE01	20.43 x 22.12 x 24.37	136	4,082
450	610	KDRL1L	14.5 x 11.38 x 9.5	110	3,385	KDRL1LE01	20.43 x 22.12 x 24.37	176	4,513
500	610	KDRL2L	14.5 x 11.38 x 9.5	110	4,934	KDRL2LE01	20.43 x 22.12 x 24.37	176	6,124
600	750	KDRL3L	15.5 x 12.75 x 11	105	6,690	KDRL3LE01	36.27 x 48 x 36.27	315	10,547
700	850	KDRS1L	15 x 11.38 x 12	158	7,314	KDRS1LE01	36.27 x 48 x 36.27	468	11,340
800	965	KDRX2L	17.32 x 18.5 x 12.85	280	10,206	KDRX2LE01	36.27 x 48 x 36.27	590	14,176

Notes:

- Contact factory for 900 HP and 1000 HP applications
- * Base Plate if needed order Part # AP03

5% IMPEDANCE, 460V

HP	AMPS	CHASSIS UNIT				UL TYPE 1 ENCLOSURE			
		PRODUCT CODE	DIMENSIONS W x H x D (in.)	WEIGHT (lbs.)	CONTROL LIST PRICE (\$)	PRODUCT CODE	DIMENSIONS W x H x D (in.)	WEIGHT (lbs.)	CONTROL LIST PRICE (\$)
1	2.3	KDRMA5H1	4.45 x 3.63 x 1.78	1.40	176	KDRMA5H1E01	12.5 x 12.25 x 6.75	11.8	446
2	3.8	KDRAA1H2	4.25 x 4.44 x 2.64	3.00	216	KDRAA1H2E01	12.5 x 12.25 x 6.75	13.4	484
3	5.4	KDRAA2H2	4.25 x 4.44 x 2.64	3.00	221	KDRAA2H2E01	12.5 x 12.25 x 6.75	13.4	490
5	8.2	KDRAA3H2	4.25 x 4.44 x 2.64	3.70	267	KDRAA3H2E01	12.5 x 12.25 x 6.75	14.1	536
7.5	12	KDRAA4H2	4.25 x 4.44 x 2.64	4.00	457	KDRAA4H2E01	14.4 x 12.25 x 6.75	4.00	909
10	14	KDRAA5H2	4.25 x 4.44 x 2.64	4.20	570	KDRAA5H2E01	12.5 x 12.25 x 6.75	14.6	1,022
15	27	KDRB2H	6 x 5 x 4	7.00	578	KDRB2HE01	12.5 x 12.25 x 6.75	17.4	1,023
20	27	KDRC3H	7.5 x 5.75 x 5	15.0	583	KDRC3HE01	12.5 x 12.25 x 6.75	25.4	1,034
25	35	KDRC1H	7.2 x 5.75 x 5	15.0	611	KDRC1HE01	12.5 x 12.25 x 6.75	25.4	1,058
30	45	KDRE2H	7.2 x 5.75 x 5	16.0	649	KDRE2HE01	12.5 x 12.25 x 6.75	26.4	1,078
40	60	KDRF4H	9 x 7 x 6	25.0	669	KDRF4HE01	15.43 x 19.13 x 15.43	62.0	1,305
50	85	KDRF1H	9 x 7 x 6	25.0	908	KDRF1HE01	15.43 x 19.13 x 15.43	62.0	1,560
60	77	KDRF2H	9 x 7 x 6	25.0	964	KDRF2HE01	15.43 x 19.13 x 15.43	62.0	1,587
75	100	KDRH2H	11 x 9 x 7	45.0	1,157	KDRH2HE01	15.43 x 19.13 x 15.43	89.0	1,792
100	125	KDRI2H	11 x 9 x 7	52.0	1,395	KDRI2HE01	15.43 x 19.13 x 15.43	118	1,962
125	160	KDRG3H	10.75 x 10.15 x 6.75	55.0	1,593	KDRG3HE01	20.43 x 22.12 x 24.37	125	2,693
150	185	KDRG1H	11 x 9 x 8	55.0	1,871	KDRG1HE01	20.43 x 22.12 x 24.37	126	3,016
200	240	KDRJ1H	11 x 9 x 9	70.0	2,529	KDRJ1HE01	20.43 x 22.12 x 24.37	141	3,686
250	310	KDRL1H	14.5 x 11.38 x 9.5	110	2,779	KDRL1HE01	20.43 x 22.12 x 24.37	171	3,856
300	365	KDRL2H	14.5 x 11.38 x 9.31	95.0	2,835	KDRL2HE01	20.43 x 22.12 x 24.37	171	3,940
350	435	KDRL3H	14.5 x 11.38 x 9.31	100	3,271	KDRL3HE01	20.43 x 22.12 x 24.37	175	4,281
400	480	KDRL4H	14.5 x 11.38 x 9.5	110	4,195	KDRL4HE01	20.43 x 22.12 x 24.37	201	5,216
450	540	KDRL5H	14.5 x 11.38 x 11	120	4,411	KDRL5HE01	28.39 x 36 x 30.19	295	6,690
500	590	KDRL6H	14.5 x 11.38 x 11	120	5,415	KDRL6HE01	28.39 x 36 x 30.19	295	7,711
600	750	KDRS1H	15 x 11.38 x 13	260	6,805	KDRS1HE01	36.27 x 48 x 36.27	582	10,660
700	840	KDRS2H	14.52 x 12.63 x 12.95	280	7,808	KDRS2HE01	36.27 x 48 x 36.27	590	12,021
800	965	KDRX2H	18.25 x 18.5 x 12.5	290	10,773	KDRX2HE01	36.27 x 48 x 36.27	615	14,629

Notes:

- Contact factory for 900 HP and 1000 HP applications
- * Base Plate if needed order Part # AP03

OUTPUT REACTORS/ LOW PASS FILTER COMBINATIONS



460V

Effective: 01-01-2022
Supersedes: 07-06-2021

Output Reactors/ Low Pass Filter Combinations (DV/DT) installed between an AC drive and a motor limit the magnitude of voltage spikes at the motor. The filter also protect cables and the motor's insulation from damage caused by PWM reflected waves.

OUTPUT REACTOR/ LOW PASS FILTER COMBINATION, 460V

HP	AMPS	CHASSIS UNIT				UL TYPE 1 ENCLOSURE			
		PRODUCT CODE	DIMENSIONS W x H x D (in.)	WEIGHT (lbs.)	CONTROL LIST PRICE (\$)	PRODUCT CODE	DIMENSIONS W x H x D (in.)	WEIGHT (lbs.)	CONTROL LIST PRICE (\$)
1	3	V1K3A00	5.5 x 9 x 7.25	8.00	601.00	V1K3A01	5.5 x 9 x 10	11.0	942
2	4	V1K4A00	5.5 x 9 x 7.25	8.00	613.00	V1K4A01	5.5 x 9 x 10	11.0	953
3	6	V1K6A00	5.5 x 9 x 7.25	8.00	624.00	V1K6A01	5.5 x 9 x 10	11.0	976
5	8	V1K8A00	5.5 x 9 x 7.25	8.00	635.00	V1K8A01	5.5 x 9 x 10	11.0	992
7.5	12	V1K12A00	5.5 x 9 x 7.25	8.00	669.00	V1K12A01	5.5 x 9 x 10	11.0	1,021
10	18	V1K18A00	5.5 x 9 x 8.25	12.0	735.00	V1K18A01	5.5 x 9 x 10	15.0	1,106
15	25	V1K25A00	5.5 x 9 x 8.25	12.0	888.00	V1K25A01	5.5 x 9 x 10	15.0	1,190
20	27	V1K27A00	5.5 x 9 x 8.25	14.0	936.00	V1K27A01	5.5 x 9 x 10	15.0	1,219
25	35	V1K35A00	8 x 12 x 9	17.0	964.00	V1K35A01	8 x 12 x 11.5	23.0	1,247
30	45	V1K45A00	8 x 12 x 9	17.0	1,010.00	V1K45A01	8 x 12 x 11.5	23.0	1,332
40	55	V1K55A00	8 x 12 x 9	17.0	1,032.00	V1K55A01	8 x 12 x 11.5	23.0	1,454
50	80	V1K80A00	8 x 12 x 9	23.0	1,470.00	V1K80A01	8 x 12 x 11.5	29.0	1,869
60	80	V1K80A00	8 x 12 x 9	23.0	1,470.00	V1K80A01	8 x 12 x 11.5	29.0	1,869
75	110	V1K110A00	8 x 12 x 10.25	40.0	1,729.00	V1K110A01	18 x 16.5 x 15	68.0	2,572
100	130	V1K130A00	11 x 9.5 x 8.5	55.0	2,042.00	V1K130A01	18 x 16.5 x 15	83.0	2,817
125	160	V1K160A00	11 x 10.5 x 8.5	60.0	2,204.00	V1K160A01	18 x 16.5 x 15	83.0	2,939
150	200	V1K200A00	11.75 x 8.5 x 10.5	60.0	2,495.00	V1K200A01	18 x 16.5 x 15	93.0	3,176
200	250	V1K250A00	11 x 10.25 x 8.5	65.0	2,608.00	V1K250A01	18 x 16.5 x 15	93.0	3,289
250	305	V1K305A00	11 x 12.25 x 8.75	80.0	2,694.00	V1K305A01	18 x 16.5 x 30	117	3,402
300	362	V1K362A00	11.75 x 12 x 8.5	80.0	3,147.00	V1K362A01	18 x 16.5 x 30	117	3,629
350	420	V1K420A00	11.75 x 13.75 x 10	95.0	3,629.00	V1K420A01	18 x 16.5 x 30	132	4,195
400	480	V1K480A00	11.75 x 13.75 x 10	100	3,919.00	V1K480A01	18 x 16.5 x 30	138	4,536
500	600	V1K600A00	15 x 13.75 x 12.75	130	4,041.00	V1K600A01	18 x 16.5 x 30	168	4,990
600	750	V1K750A00	15 x 14.75 x 12.75	135	6,491.00	V1K750A01	18 x 16.5 x 30	180	8,619

Notes:

1. Contact factory for applications above 600 HP.

LOW VOLTAGE SOLID STATE STARTERS (LVSS)

TECO-Westinghouse can supply low voltage solid state starters for a variety of applications such as pumping, compression, saws (woodworking), crushing and grinding operations.

HEAVY DUTY (HD) PANELS INCLUDE:

- NEMA 3R enclosure
- Circuit breaker with flanged disconnect (service entrance rated)
- EMX3 heavy duty solid state starter
- Panel mounted switch: Soft Start/OFF/Line Start
- 110V control power transformer
- Space heater with thermostat
- The Drive is then evaluated and a Service Report is generated detailing the failure.
 - Start / Stop Pushbutton
 - Local / Remote Switch
 - Reset Pushbutton
 - Power On Light
 - Run Light
 - Fault Light

STANDARD STARTER FEATURES (CHASSIS):

- Voltage Ratings: 208, 230, 460, 575 or 690VAC
- 15-1200HP (Standard duty)
- Constant Current, Current Ramp, XLR-8 Adaptive Acceleration, Kickstart
- LCD Keypad with real time monitoring and event log:
 - Graphical Display
 - User Friendly
 - Copy program setting between starters
 - Removable for remote mounted
- Emergency Run Mode
- RS 485 Communications via optional Modules
 - Modbus, Profibus, ProfiNET, DeviceNET, Modbus TCP, Ethernet IP
- PC Configuration Software Available

ENGINEERED PACKAGES:

- Fused disconnect or circuit breaker disconnect
- Internal shunt bypass or continuous duty
- Light, standard and heavy duty ratings
- Operator devices and pilot lights
- Fans, filters and enclosure modifiers
- Door-Mounted LCD Keypad

CHASSIS STARTERS - LOW VOLTAGE

Effective: 01-01-2022
 Supersedes: 07-06-2021



CHASSIS - W / BUILT-IN BYPASS

MODEL	STANDARD DUTY		HEAVY DUTY		DIMENSIONS (in.)			WEIGHT (lbs.)	LIST PRICE (\$) EACH
	HP	MAX AMPS	HP	MAX AMPS	HEIGHT	WIDTH	DEPTH		
EMX4i-0024B-V5-C1-H	10	17	10	14	13.2	6.0	9.1	11.0	2,302
EMX4i-0042B-V5-C1-H	20	27	15	22	13.2	6.0	9.1	11.0	2,392
EMX4i-0052B-V5-C1-H	25	34	20	29	13.2	6.0	9.1	11.0	2,471
EMX4i-0064B-V5-C1-H	40	52	25	40	13.2	6.0	9.1	11.0	2,583
EMX4i-0069B-V5-C1-H	40	59	30	46	13.2	6.0	9.1	11.0	2,960
EMX4i-0105B-V5-C1-H	60	77	40	52	13.2	6.0	9.1	12.0	3,169
EMX4i-0115B-V5-C1-H	60	81	50	65	13.2	6.0	9.1	12.0	3,546
EMX4i-0184B-V5-C1-H	100	124	75	96	19.5	8.5	9.6	28.0	4,446
EMX4i-0200B-V5-C1-H	100	131	75	104	19.5	8.5	9.6	28.0	4,568
EMX4i-0229B-V5-C1-H	125	156	100	124	19.5	8.5	9.6	28.0	5,135
EMX4i-0250B-V5-C1-H	150	195	125	196	19.5	8.5	9.6	28.0	6,668

Notes:

- * Includes integral bypass for 'B' models.
- 1. Built-to-order: Please allow 1-2 weeks for shipment of complete TEAMMaster™ unit when ordering these options to a stock starter.
- 2. Engineered Packages are not standard stock; Contact Factory for Lead Times
- 3. All Models listed are for 460 VAC input and based on Standard Duty FLA. Contact factory for other ratings. Dimensions and weights are approximate.



HEAVY DUTY WITH ACROSS -THE-LINE BYPASS

TWE-460V						NEMA 3R	
MODEL NO.	HP	FLA AMPS	DIMENSIONS (in.)			WEIGHT (lbs.)	CONTROL LIST PRICE (\$)
			HEIGHT	WIDTH	DEPTH		
*TWE-0014B-4-HD	10	14	36	32	12	220	8,500
*TWE-0027B-4-HD	20	27	36	32	12	220	8,750
*TWE-0034B-4-HD	25	34	36	32	12	220	8,931
*TWE-0040B-4-HD	30	40	36	32	12	220	9,025
*TWE-0052B-4-HD	40	52	36	32	12	220	9,060
*TWE-0065B-4-HD	50	65	36	32	12	240	9,777
TWE-0077C-4-HD	60	77	36	32	12	240	11,300
TWE-0096C-4-HD	75	96	48	38	16	295	11,655
TWE-0125C-4-HD	100	125	48	38	16	295	13,433
TWE-0156C-4-HD	125	156	48	38	16	320	14,225
TWE-0180C-4-HD	150	180	48	38	16	340	15,780
TWE-0240C-4-HD	200	240	48	38	16	355	18,500
TWE-0302C-4-HD	250	302	48	38	16	360	21,000
TWE-0360C-4-HD	300	360	48	38	16	370	21,465
TWE-0414C-4-HD	350	414	72	38	16	550	27,640
TWE-0477C-4-HD	400	477	90	40	16	800	29,400
TWE-0515C-4-HD	450	515	90	40	18	800	31,005
TWE-0590C-4-HD	500	590	90	40	18	850	35,300
TWE-0720C-4-HD	600	720	90	40	18	850	39,010
TWE-0840C-4-HD	700	840	90	40	18	850	57,000
TWE-0960C-4-HD	800	960	90	72	20	1100	67,500
TWE-1080C-4-HD	900	1080	90	72	20	1100	73,000
TWE-1200C-4-HD	1000	1200	90	72	20	1100	81,500

Notes:

- * Includes integral bypass for 'B' models.
- 1. Built-to-order: Please allow 1-2 weeks for shipment of complete TEAMMaster™ unit when ordering these options to a stock starter.
- 2. Engineered Packages are not standard stock; Contact Factory for Lead Times.
- 3. All Models listed are for 460 VAC input . Contact factory for other ratings. Dimensions and weights are approximate
NEMA 3R = 3R



Engineered to provide solutions for a variety of heavy duty applications, TEAMMASTER™ Medium Voltage Soft Starters are feature loaded. They are an excellent solution to Crushers, Grinders, Ball & Hammer Mills, Compressors, Centrifuges, plus many other options.

COMBINATION PANELS INCLUDE:

- NEMA 12, NEMA 3R, NEMA 3ROD (door in door design), and Custom
- UL 347 Listed 6th Edition, Class E2
- 60kV BIL
- Short Circuit Fault Rated 200MVA (2300V), 350MVA (4160V)
- 6500 PIV, UL347 – 6th Edition Certified and Listed at 2.4kV
- 13,000 PIV, UL347 – 6th Edition Certified and Listed at 4.16kV
- Fiber-Optic Firing
- 500% - 30 Second Rated (adjustable and customizable per applications)
- Load Break 5kV Switch, w/Viewing Window, Grounding Assembly, and Mechanically Interlocked Lockable Handle.
- Load matched Class R Fusing
- Fixed mounted Vacuum Contactors (Line Isolation & Bypass) Full Horsepower Rated
- Smart keypad/HMI with multiline display
- Simulation Mode Feature for “quick commissioning”
- Sim Card data logging for remote factory assistance
- Emergency Full Voltage Switch (located in LV compartment for Across Line Starting backup)
- Adjustable Electronic Overload for Emergency mode
- 120V Control Power Transformer
- Door Mounted: Start/Stop Pushbutton, Emergency Stop Pushbutton, and Run/Stop/Fault Lights
- Additional Options Adders :
 - Door Mounted Keypad
 - Communications: Modbus, Modbus TCP, USB, DeviceNet, Profibus, Profinet, Ethernet IP
 - Top Hat and/or Horizontal Bussing
 - Space Heater with Thermostat

ACROSS -THE-LINE BYPASS

2300 VOLT NEMA 12							
MODEL NO.	HP	FLA AMPS	DIMENSIONS (in.)			WEIGHT (lbs.)	NEMA 12
			HEIGHT	WIDTH	DEPTH		LIST PRICE (\$)
TMVE-0110-V02-N12	500	110	92.5	36	30	1800	64,500
TMVE-0200-V02-N12	900	200	92.5	36	30	1800	65,700
TMVE-0360-V02-N12	1750	360	92.5	36	30	1800	67,100

4160 VOLT NEMA 12							
MODEL NO.	HP	FLA AMPS	DIMENSIONS (in.)			WEIGHT (lbs.)	NEMA 3R
			HEIGHT	WIDTH	DEPTH		LIST PRICE (\$)
TMVE-0110-V04-N12	900	110	92.5	36	30	1800	68,100
TMVE-0200-V04-N12	1500	200	92.5	36	30	1800	70,000
TMVE-0360-V04-N12	3000	360	92.5	36	30	1800	73,200

2300 VOLT NEMA 3R							
MODEL NO.	HP	FLA AMPS	DIMENSIONS (in.)			WEIGHT (lbs.)	NEMA 12
			HEIGHT	WIDTH	DEPTH		LIST PRICE (\$)
TMVE-0110-V02-N3R	500	110	92.5	36	30	2000	65,700
TMVE-0200-V02-N3R	900	200	92.5	36	30	2000	67,350
TMVE-0360-V02-N3R	1750	360	92.5	36	30	2000	69,090

4160 VOLT NEMA 3R							
MODEL NO.	HP	FLA AMPS	DIMENSIONS (in.)			WEIGHT (lbs.)	NEMA 3R
			HEIGHT	WIDTH	DEPTH		LIST PRICE (\$)
TMVE-0110-V04-N3R	900	110	92.5	36	30	2000	70,800
TMVE-0200-V04-N3R	1500	200	92.5	36	30	2000	71,500
TMVE-0360-V04-N3R	3000	360	92.5	36	30	2000	74,700

MODULAR OPTIONS

MODEL	STANDARD OPTIONS	LIST PRICE (\$)
ES	E-Stop (Red Mushroom Head)	350
RTD	12 – RTD input	2,900
TP	Top Entry Top Hat (18" x 36" x 20")	1,770
DN	DeviceNet Interface	560
PB	Profibus Interface	690
PN	Profinet Interface	1,570
IP	Ethernet IP Interface	1,260
TCP	Modbus TCP Interface	1,200
MB	Modbus Interface	375

Notes:

- (1) Starters are top entry. Bottom exit available upon request. Dimensions and weights are approximate.
- (2) Power fuses ship loose. Please provide motor full load amps at time of order for proper fuse sizing.
- (4) The TEAMMaster™ series was designed as an integrated package.
Listed above are the available modular options. For systems requiring more extensive requirements, please call the factory.
- (6) Built-to-order: Please allow 1-2 weeks for shipment of complete TEAMMaster™ unit when ordering these options to a stock starter.

MEDIUM VOLTAGE DRIVES



Effective: 01-01-2022
Supersedes: 07-06-2021



With over 100 years of experience in motor design and application, TECO-Westinghouse Motor Company is a premier supplier of AC and DC motors and generators. Ranging from fractional HP ratings to 100,000 HP, these high-quality machines are used in a variety of rugged applications across several industries throughout the world.

TECO-Westinghouse comprises the experience of Westinghouse, a leader in the motor industry since 1888, and TECO Electric & Machinery Co, Ltd., a multinational conglomerate with over 50 years of manufacturing experience. Together, TECO-Westinghouse embodies the capabilities and proud traditions of excellence from both companies and carries them forward.

In keeping with this idea, TECO-Westinghouse is pleased to now offer a complete package of Variable Speed Drive (VSD) systems that includes an Input/ Output Switchgear, Medium Voltage Drive (MVD), and motors.

VersaBridge® MVDs provide reliable motor control for a variety of industry specific and general purpose applications including Oil & Gas, Utility/ Power Generation, Metals and Mines. These patented MVDs are designed utilizing a multilevel H-Bridge topology that reduces the harmonic levels to extremely low levels. The modular design facilitates ease of installation, commissioning and maintenance. The VersaBridge® is an innovative product that combines reliable, simple, and compact solutions with the latest power electronics and cooling technologies.

FEATURES

Modularity: Modular design with common building blocks (Mains, Slices, Cubes) make VersaBridge® MVD scalable for different power and voltage ratings with fewer spare parts required. Power switching modules (Cubes) can be easily removed in the event of a failure.

Quick and Easy Installation: VersaBridge® MVD provides both top and bottom cable entry as standard on all models. All shipping sections are delivered to the customer pre-terminated, making field assembly fast and efficient.

Serviceability: VersaBridge® power cubes are interchangeable and can be easily replaced within 30 minutes. Additionally, the modular design of VersaBridge® MVD requires few spare parts since the parts are universal and can be used in any configuration regardless of the voltage or power class.

Multi-level, Cascaded H-Bridge Topology produces near sinusoidal voltage output which reduces motor harmonics and torque pulsations, even at low speeds with virtually no cable length restriction. VersaBridge® MVD produces an output voltage which has at least 7 levels measured line-to-neutral and 13 levels measured line-to-line, allowing VersaBridge MVDs to be applied to new or existing motors having standard insulation systems without the need for harmonic mitigation.

Ultra Low Utility-Side Harmonics exceed the IEEE-519 Standard requirements without any additional components.

Power Cube Bypass: VersaBridge® MVD keeps your system running reliably by automatically bypassing failed power cubes and continuing operation within ¼ of a second of the initiating fault event. VersaBridge® cube bypass is software configurable to be Automatic or Manual. Both modes of bypass are designed to eliminate unnecessary voltage stress on the motor by keeping the neutral voltage balanced.

N+1...N+N Redundancy: Due to the modularity of VersaBridge® MVD, redundant Slices can be added to any system (new installation or retrofit) to achieve N+1 or more redundancy. This ensures that the process continues to operate at full rated power after a power cube bypass event.

Flying Start into a Spinning Load: VersaBridge® MVD offers the ability to smoothly catch and accelerate a spinning load without producing any severe torque, voltage, or current transients on the driven equipment.

Power Dip Ride-Through: VersaBridge® MVD provides greater than five cycle power loss ride-through to keep the process running without the need for auxiliary UPS systems.

One Drive for Multiple Motors: Using the VersaBridge® MVDs' Synchronous Transfer feature, multiple motors can be started and synchronously transferred from the drive bus to the utility bus (Up Transfer) or from the utility bus to the drive bus (Down Transfer).

Industry Standard Modbus TCP Communication: Standard protocols allow the VersaBridge® MVDs to easily integrate with various SCADA or DCS systems using Ethernet.



Electrical

Output voltage	0 – 13.8 kV
Output frequency Min - Max	0 – 120 Hz
Auxiliary Supply	200 – 240 V, 1φ std; optional configurations available
Rated Supply Voltage	2.3 – 13.8 kV ±10%
Rated System Frequency	60 Hz ±5%
Voltage Variation	-30% to +10% for 30 line cycles
Input Current Harmonics THD	≤ 2% exceeds IEEE-519 requirements (36-pulse)
Inverter Topology	IGBT H-Bridge
Cooling	Advanced 2-phase cooling, forced-air cooling
Capacitors	Film
Regulatory Compliance	IEEE, ANSI, NEMA, CSA, cUL (listed), UL (listed)
Controls	V/Hz, Vector
Speed Regulation	0.1% with feedback, 0.5% without feedback
Connection	Top, bottom or both cable entry/exit
Power Dip Ride Through	Minimum 5 cycles
Peak Efficiency	97%
Power Factor	>96%
Output Current Harmonics THD	<1%
Power Transformer Topology	Modular, multi-pulse, phase-shifted, isolated
Power Transformer Rating	Custom design based on HP rating
Spinning Load	Catch a spinning load
Power Cube Bypass	Auto Bypass and restart, Manual Bypass modes
Synchronous Transfer	Automatically transfer the motor to/from the utility bus
Control Isolation	Fiber optic cable
Service Duty	CT: 150% , VT: 110% for 1 min every 10 min
HMI	10" PC, Resistive/ Color Touch Screen
Communication Interface	Modbus TCP/IP (Ethernet), RS-232 , and RS-485, PLC I/O, Others Available Upon Request

Mechanical

Standard Rating	NEMA 1, NEMA 3R
Cabinet Dimension (Mains or Slice)	H: 105" x W: 25" x D: 68.4"
Material	ASTM A366 steel
Color	Light Grey
Total Weight	Mains: 1,289 lbs, Slice: 4,852 lbs

Environmental Condition

Ambient Temperature	-20 to +40 °C (lower/higher temperatures*)
Altitude	0 – 1000m (higher elevations*)
Humidity	95%, non-condensing
Noise Level	≤ 78 dB

* Consult factory for extended temperature or altitude ranges

Cooling System

Transformer	Choice of forced-air cooling or advanced 2-phase cooling options
Electronics	Advanced 2-phase cooling
Cooling Unit	Remote unit

DRIVE RMA RETURN PROCEDURE

Effective: 01-01-2022
Supersedes: 07-06-2021

DRIVE RMA RETURN PROCEDURE

- Contact a Drives Engineer for technical troubleshooting/ RMA Qualification
- TECO-Westinghouse will email or fax an RMA Request Form to complete. Completed RMA Request Form should be returned via e-mail controlswarranty@tecowestinghouse.com or faxed to 512-218-7378 for processing.
- An RMA number will be issued and sent via e-mail or fax. Detailed instructions on where to ship the drive for warranty evaluation/ repair will be included with the RMA number.

******* IF PRODUCT IS NOT RETURNED WITHIN 30 DAYS, THE RMA WILL BE CLOSED. *******

- The Drive will be evaluated and a Service Report generated detailing the failure.
- A copy of the Service Report will be sent to the requesting party via e-mail or fax.
- If the Drive is determined to have failed under Warranty, either of the following will take place, whichever is deemed more appropriate:
 1. The drive will be repaired and returned to the customer.
 2. The drive will be determined to be un-repairable and will be replaced.
 3. If the drive is determined to be functioning properly, the drive will be returned to the customer and considered non-warranty.

****** If credit is being issued, the Controls Group will fax a copy to the customer. ******

If the failure/problem is determined to be a non-warranty situation, there is a \$250.00 inspection fee for the evaluation and one of the following three actions will take place.

1. The drive will be returned to the customer via freight collect no later than 60 days after disposition. If the drive is repairable, an estimate will be sent. TECO-Westinghouse will have to receive a PO before any repairs are complete.
2. There is a \$250.00 inspection fee for this evaluation. If TECO-Westinghouse repairs the drive, this \$250.00 will be credited to the repair charges.
3. If the drive is un-repairable or TECO-Westinghouse is directed to not repair the unit, TWMC will return the drive via freight collect at the customers option no later than 60 days after disposition.

Please Note: All repairable and properly functioning drives will be returned even if an offsetting order has been made for a replacement unit.

TECO Westinghouse

APPLICATION CHECKLIST FOR TVMC VARIABLE FREQUENCY DRIVES

The following checklist is provided to gather the necessary information to ensure that our product will meet your requirements and we can provide the most cost effective solution for your application.

** Please complete with as much detail as possible and fax this form to 512-218-7378. **

DATE: _____

General Information

Customer: _____

Contact Information - Name: _____ Phone: _____

Fax: _____ Email: _____

TVMC Salesperson: _____

Application Description: _____

Quote Due Date _____

Driven Load Information/ Details

Quantity: _____ HP _____ HP (unit 2) _____ HP (unit 3) _____ HP (unit 4) _____

Load Description Variable Torque Constant Torque Machine Type: _____

Accel time: _____ sec from _____ RPM to _____ RPM

Decel time: _____ sec from _____ RPM to _____ RPM

Ratio or Minimum Speed _____ Maximum Speed _____

Duty Cycle Information _____

Vertical Load? Yes No If yes, please indicate weight of load _____

AC Motor Details

New Existing Manufacturer _____ Model # _____

HP _____ Rated Speed _____ Rated Frequency _____ Rated Voltage _____ Frame _____

FLA _____ Service Factor _____ Insulation Class _____ Enclosure _____

Number of Motors: _____ Cable Distance from Motor to Drive: _____

Tach/ Generator/ Encoder: _____ Pulses per Revolution Single Channel Dual Channel

TECO Westinghouse

Line Power Supply

Voltage _____ Frequency _____

Generator Power Yes No If yes, indicate generator capacity: _____

Reactors or isolation transformer required? _____ Existing? _____

Serial Communications

Modbus Johnson Metasys Profibus BACNet LonWorks Siemens FLN Other _____

Monitor only or control? _____ Baud Rate _____

Drive Enclosure/ Environment

NEMA Rating NEMA 1 NEMA 12 NEMA 3R NEMA 4 NEMA 4X

(See attachment for NEMA definitions.)

Wall Mounted Free Standing Installed Units in MCC Indoor Installation Outdoor Installation

Ambient Temperature Range: _____

Elevation _____

AC Drive Control Characteristics

Speed Reference Source*: _____ (4-20mA, 0-10VDC, Keypad, Speed Pot, Serial)

Run/ Stop Command Source*: _____ (Keypad, Terminal I/O, Serial)

Stop Function Types*: _____ (E-stop, Coast to Stop, Interlocks)

PID Control Based on Process Input Pressure Temperature Other _____

Protective Function: _____ (Motor Thermostat, PTC, RTD)

Braking Requirements: _____ (Dynamic Braking, Mechanical, or Other)

Other Inputs: _____ (Reset, Auto Restart, Encoder)

Analog Outputs: _____ (4-20mA, 0-10VDC, Pulse)

Digital Outputs: _____ (Run, Fault, High or Low Speed, etc.)

Two or Three Wire Start: _____ (Applies to Terminal I/O Only)

Communications: _____ (Telephone Modem, Wireless Modem, Ethernet)

Options: _____ (Analog, Serial, Relay)

*Indicate if Door Mounted

ENCLOSURE OPTIONS AND MODIFICATIONS

Auxiliary Equipment

(Mounted and wired in an enclosure as specified per the NEMA rating selected.)

- Manual or Automatic Bypass 3-Contactor 2-Contactor
- Motor Overload Relay
- Input Circuit Breaker Input Disconnect Fused Non-fused
- AC Drive Fuses Blower Motor Starter
- Output Load Reactors Output Contactor
- dV/dt Filters Dynamic Braking
- Control Power Transformer Secondary Volts _____ Capacity _____ VA
- Interior Mounted 120VAC Power Outlet Interior Cabinet Lighting
- Additional Power Supply Interior Cabinet Lighting 120VAC 240VAC Other _____
- Heat Sink Extension

Auxiliary Controls (Please specify devices in the Project Description below.)

- Operator Controls Door Mounted Remote
- Control Terminals Pilot Lights
- Pushbuttons Speed Potentiometer
- Control Power Supply Volts _____ Capacity _____ mA
- Transfer to Bypass on Fault Fireman's Override
- Damper Actuation on Start Time Delay on Bypass Transfer

Input Power Quality Conditioning

- Line Reactors Isolation Transformers
- Active Harmonics Filter EMC Suppression
- EMF/ RFI Filters Line Noise Filter
- Lightning Arrestors

Documentation

Number of Copies _____

- Wiring Diagrams Dimensional Drawings
- Cabinet Layout Drawings Additional Instruction Manuals

Support Services

- Spare Parts List Service/ Start up Assistance
- Witness Testing

Special Optional Requirements _____

PROJECT DESCRIPTION

NEMA ENCLOSURE RATING DESCRIPTIONS

NEMA 1 – Enclosures constructed for indoor use to provide a degree of protection to personnel against incidental contact with the enclosed equipment and to provide a degree of protection against falling dirt.

NEMA 3R – Enclosures constructed for either indoor or outdoor use to provide a degree of protection to personnel against incidental contact with the enclosed equipment; to provide a degree of protection against falling dirt, rain, sleet, and snow; and that will be undamaged by the external formation of ice on the enclosure.

NEMA 4 – Enclosures constructed for either indoor or outdoor use to provide a degree of protection to personnel against incidental contact with the enclosed equipment; to provide a degree of protection against falling dirt, rain, sleet, snow, windblown dust, splashing water, and hose-directed water; and that will be undamaged by the external formation of ice on the enclosure. Contact the factory if NEMA 4 is required for your application.

NEMA 4X – Same as NEMA 4, but also including protection against corrosion. Contact the factory if NEMA 4X is required for your application.

NEMA 12 (UL1) – Enclosures constructed (without knockouts) for indoor use to provide a degree of protection to personnel against incidental contact with the enclosed equipment; to provide a degree of protection against falling dirt; against circulating dust, lint, fibers, and flyings; and against dripping and light splashing of liquids.

GLOBAL CAPABILITIES

With over 130 years of experience in motor design, **TECO-Westinghouse** is a premier manufacturer of AC & DC motors and generators. From 1/3 HP to 100,000 HP, these high quality machines are used to drive pumps, fans, compressors and a variety of other rugged applications in oil & gas, petrochemical, electric utility, water/wastewater and other industries throughout the world. We also offer complementing low and medium voltage AC inverters and motor starters, as well as green energy products.

A pioneer in industrial manufacturing, TECO-Westinghouse has factories in the US, Taiwan, China, Malaysia, Italy and the Middle East. The Global Design Center for Engineering and Research & Development is headquartered in the US, and the team extends through Taiwan and China. Locally in the US, there are several regional warehouses stocking a vast array of motors and inverter products for customers' convenience and to minimize downtime in the event of an emergency. Additionally, aftermarket services and repairs for large motors are available from the factory in Round Rock, Texas.

These global resources uniquely position TECO-Westinghouse to satisfy the market's diverse needs, providing high quality product solutions and services through a strong customer support team.

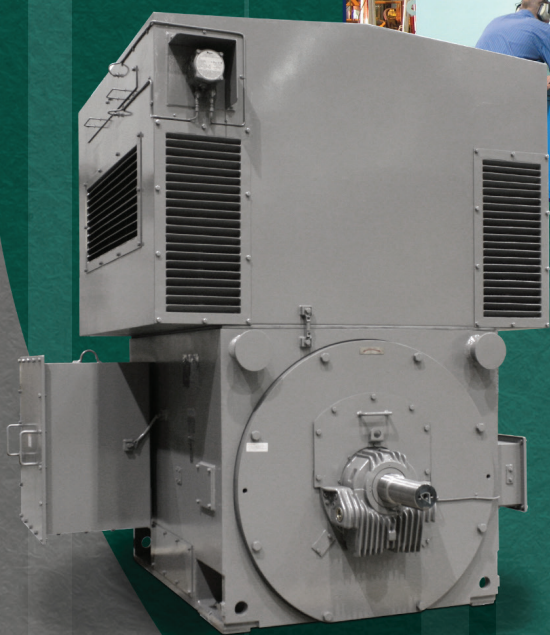

TECO   **Westinghouse**

5100 N. IH-35
Round Rock, Texas 78681
1-800-USE-TECO (1-800-873-8326)

www.tecowestinghouse.com